



Report No.: EA21070082F01001

1 of 78

**ELECTROMAGNETIC EMISSIONS COMPLIANCE REPORT  
INTENTIONAL RADIATOR CERTIFICATION TO  
FCC PART 15 SUBPART C REQUIREMENT**

*OF*

**White Daisy Shower Speaker**

**Model No.: UO-BTSS-WHDSY**

**Trademark: N/A**

**FCC ID: 2A2IPU0BTSSWHDSY**

**Report No.: EA21070082F01001**

**Issue Date: July 12, 2021**

*Prepared for*

**DONGGUAN XIANGSHENG ELECTRONIC TECHNOLOGY CO.,LTD**

**Area B, 4th Floor, Building C, Guancheng San Liang Smart Industrial Park,  
Xing Guang Village, Huang Jiang Town, Dong Guan City, China**

*Prepared by*

**Dong Guan Anci Electronic Technology Co., Ltd.**

**1-2 Floor, Building A, No.11, Headquarters 2 Road, Songshan, Lake Hi-tech  
Industrial Development Zone, Dongguan City, evelopment Zone,  
Dongguan City, Guangdong Pr., China.**

**This report shall not be reproduced, except in full, without the written approval of  
Dong Guan Anci Electronic Technology Co., Ltd.**

**VERIFICATION OF COMPLIANCE**

Applicant:	DONGGUAN XIANGSHENG ELECTRONIC TECHNOLOGY CO.,LTD Area B, 4th Floor, Building C, Guancheng San Liang Smart Industrial Park, Xing Guang Village, Huang Jiang Town, Dong Guan City, China
Manufacturer:	DONGGUAN XIANGSHENG ELECTRONIC TECHNOLOGY CO.,LTD Area B, 4th Floor, Building C, Guancheng San Liang Smart Industrial Park, Xing Guang Village, Huang Jiang Town, Dong Guan City, China
Product Description:	White Daisy Shower Speaker
Trade Mark:	N/A
Model Number:	UO-BTSS-WHDSY

**We hereby certify that:**

The above equipment was tested by Dong Guan Anci Electronic Technology Co., Ltd. The test data, data evaluation, test procedures, and equipment configurations shown in this report were made in accordance with the procedures given in ANSI C63.10-2013 and the energy emitted by the sample EUT tested as described in this report is in compliance with conducted and radiated emission limits of FCC Rules Part 15.247(2020).

Date of Test : July 05, 2021 to July 11, 2021

Prepared by : Tomas Yang/Supervisor

Reviewer &  
Authorized Signer : Alan He/Manager



### Modified Information

Version	Summary	Revision Date	Report No.
Ver.1.0	Original Report	/	EA21070082F01001



# Table of Contents

- 1. GENERAL INFORMATION ..... 6**
  - 1.1 PRODUCT DESCRIPTION ..... 6
  - 1.2 TEST METHODOLOGY ..... 6
  - 1.3 TEST FACILITY ..... 7
- 2. SYSTEM TEST CONFIGURATION..... 8**
  - 2.1 EUT CONFIGURATION ..... 8
  - 2.2 EUT EXERCISE..... 8
  - 2.3 TEST PROCEDURE..... 8
  - 2.4 CONFIGURATION OF TESTED SYSTEM..... 9
- 3. SUMMARY OF TEST RESULTS..... 10**
- 4. DESCRIPTION OF TEST MODES ..... 11**
- 5. TEST SYSTEM UNCERTAINTY ..... 12**
- 6. CONDUCTED EMISSIONS TEST ..... 13**
  - 6.1 MEASUREMENT PROCEDURE: ..... 13
  - 6.2 TEST SET-UP (BLOCK DIAGRAM OF CONFIGURATION) ..... 13
  - 6.3 MEASUREMENT EQUIPMENT USED: ..... 13
  - 6.4 MEASUREMENT RESULT: ..... 14
  - 6.5 CONDUCTED MEASUREMENT PHOTOS: ..... 17
- 7. RADIATED EMISSION TEST ..... 18**
  - 7.1 MEASUREMENT PROCEDURE ..... 18
  - 7.2 TEST SET-UP (BLOCK DIAGRAM OF CONFIGURATION) ..... 20
  - 7.3 MEASUREMENT EQUIPMENT USED: ..... 21
  - 7.4 RADIATED EMISSION LIMIT ..... 22
  - 7.5 MEASUREMENT RESULT ..... 23
  - 7.5 RADIATED MEASUREMENT PHOTOS: ..... 31
- 8. CHANNEL SEPARATION TEST ..... 32**
  - 8.1 MEASUREMENT PROCEDURE ..... 32
  - 8.2 TEST SET-UP (BLOCK DIAGRAM OF CONFIGURATION) ..... 32
  - 8.3 MEASUREMENT EQUIPMENT USED: ..... 32
  - 8.4 MEASUREMENT RESULTS: ..... 32
- 9. 20DB BANDWIDTH TEST ..... 39**
  - 9.1 MEASUREMENT PROCEDURE ..... 39
  - 9.2 TEST SET-UP (BLOCK DIAGRAM OF CONFIGURATION) ..... 39
  - 9.3 MEASUREMENT EQUIPMENT USED: ..... 39
  - 9.4 MEASUREMENT RESULTS: ..... 39
- 10. QUANTITY OF HOPPING CHANNEL TEST ..... 46**



- 10.1 MEASUREMENT PROCEDURE ..... 46
- 10.2 TEST SET-UP (BLOCK DIAGRAM OF CONFIGURATION)..... 46
- 10.3 MEASUREMENT EQUIPMENT USED:..... 46
- 10.4 MEASUREMENT RESULTS: ..... 46
- 11. TIME OF OCCUPANCY (DWELL TIME) TEST ..... 47**
  - 11.1 TEST DESCRIPTION..... 47
  - 11.2 TEST SET-UP (BLOCK DIAGRAM OF CONFIGURATION)..... 47
  - 11.3 MEASUREMENT EQUIPMENT USED:..... 47
  - 11.4 TEST REQUIREMENTS / LIMITS..... 47
  - 11.5 TEST RESULT ..... 48
- 12. MAXIMUM PEAK OUTPUT POWER TEST ..... 50**
  - 12.1 MEASUREMENT PROCEDURE ..... 50
  - 12.2 TEST SET-UP (BLOCK DIAGRAM OF CONFIGURATION)..... 50
  - 12.3 MEASUREMENT EQUIPMENT USED:..... 50
  - 12.4 MEASUREMENT RESULTS: ..... 51
- 13. BAND EDGE TEST ..... 57**
  - 13.1 MEASUREMENT PROCEDURE ..... 57
  - 13.2 TEST SET-UP (BLOCK DIAGRAM OF CONFIGURATION)..... 58
  - 13.3 MEASUREMENT EQUIPMENT USED:..... 58
  - 13.4 MEASUREMENT RESULTS: ..... 59
- 14. ANTENNA APPLICATION ..... 74**
  - 14.1 ANTENNA REQUIREMENT ..... 74
  - 14.2 RESULT..... 74
- 15. PHOTOS OF EUT ..... 75**

## 1. GENERAL INFORMATION

### 1.1 Product Description

Characteristics	Description
Product Name	White Daisy Shower Speaker
Model number	UO-BTSS-WHDSY
Input rating	DC 5V, 0.5A
Power Supply	AC 120V for Adapter and Battery 3.7V
Kind of Device	Bluetooth Ver.5.0+EDR
Modulation	GFSK, $\pi/4$ -DQPSK, 8DPSK
Operating Frequency Range	2402-2480MHz
Number of Channels	79
Transmit Power Max(PK)	3.21dBm(0.0021W)
Antenna Type	PCB antenna
Antenna Gain	0dBi

### 1.2 Test Methodology

Both conducted and radiated testing was performed according to the procedures in ANSI C63.10-2013. Radiated testing was performed at an antenna to EUT distance 3 meters.

### 1.3 Test Facility

#### Site Description

EMC Lab. : Accredited by CNAS, 2017.06.26  
The certificate is valid until 2022.10.28  
The Laboratory has been assessed and proved to be in compliance with CNAS-CL01:2006 (identical to ISO/IEC 17025:2005)  
The Certificate Registration Number is L0468.

Accredited by A2LA, 2018.03.15  
The Certificate Number is 4422.01.

Name of Firm : Dong Guan Anci Electronic Technology Co., Ltd.  
Site Location : 1-2 Floor, Building A, No.11, Headquarters 2 Road, Songshan, Lake Hi-tech Industrial Development Zone, Dongguan City, evelopment Zone, Dongguan City, Guangdong Pr., China.

## **2. System Test Configuration**

### **2.1 EUT Configuration**

The EUT configuration for testing is installed on RF field strength measurement to meet the Commissions requirement and operating in a manner which intends to maximize its emission characteristics in a continuous normal application.

### **2.2 EUT Exercise**

The Transmitter was operated in the normal operating mode. The Tx frequency was fixed which was for the purpose of the measurements.

### **2.3 Test Procedure**

#### **2.3.1 Conducted Emissions**

The EUT is placed on a turn table which is 0.8 m above ground plane. According to the requirements in Section 13.1.4.1 of ANSI C63.10-2013. Conducted emissions from the EUT measured in the frequency range between 0.15 MHz and 30MHz using CISPR Quasi-Peak and average detector mode.

#### **2.3.2 Radiated Emissions**

Below 1000MHz, The EUT was placed on a turn table which is 0.8m above ground plane. And above 1000MHz, The EUT was placed on a styrofoam table which is 1.5m above ground plane. The turn table shall rotate 360 degrees to determine the position of maximum emission level. EUT is set 3m away from the receiving antenna which varied from 1m to 4m to find out the highest emission. And also, each emission was to be maximized by changing the polarization of receiving antenna both horizontal and vertical. In order to find out the max. emission, the relative positions of EUT was fixed in a particular direction according to the requirements in Section 13.1.4.1 of ANSI C63.10-2013.



## 2.4 Configuration of Tested System

**Fig. 2-1 Configuration of Tested System**

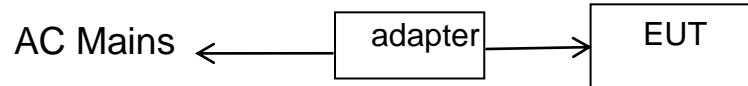

Table 2-1 Equipment Used in Tested System

Item	Equipment	Trademark	Model No.	FCC ID	Note
1.	White Daisy Shower Speaker	N/A	UO-BTSS-WHDSY	2A2IPU0BTSS WHDSY	<b>EUT</b>
2	Adapter	FLYPOWER	Model:PS06C050K2000U Input: 100-240V~,50/60Hz,0.25A Output: DC 5V,2A	N/A	<b>Support EUT</b>

**Note:**

- (1) Unless otherwise denoted as EUT in 『Remark』 column , device(s) used in tested system is a support equipment.



### 3. Summary of Test Results

<b>FCC Rules</b>	<b>Description Of Test</b>	<b>Result</b>
§15.207	AC Power Conducted Emission	Compliant
§15.247(d),§15.209	Radiated Emission	Compliant
§15.247(a)(1)	Channel Separation test	Compliant
§15.247(a)(1)	20dB Bandwidth	Compliant
§15.247(a)(1)(iii)	Quantity of Hopping Channel	Compliant
§15.247(a)(1)(iii)	Time of Occupancy(Dwell Time)	Compliant
§15.247(b)	Max Peak output Power test	Compliant
§15.247(d)	Band edge test	Compliant
§15.203	Antenna Requirement	Compliant

#### 4. Description of test modes

The EUT has been tested under its typical operating condition for EUT tested alone. Pre-defined engineering program for regulatory testing used to control the EUT for staying in continuous transmitting. Only the worst case data were reported.

The EUT has been associated with peripherals pursuant to ANSI C63.10-2013 and configuration operated in a manner tended to maximize its emission characteristics in a typical application. Frequency range investigated: radiation (9 KHz to the 10th harmonics of the highest fundamental frequency or to 40 GHz, whichever is lower).

The EUT has been tested under TX operating condition. This EUT is a FHSS system, were conducted to determine the final configuration from all possible combinations. We use software control the EUT, Let EUT hopping on and transmit with highest power, all the modes GFSK,  $\pi/4$ -DQPSK, 8DPSK have been tested. 79 Channels are provided by EUT. The 3 channels of lower, medium and higher were chosen for test.

Channel	Frequency(MHz)
1	2402
40	2441
79	2480



### 5. TEST SYSTEM UNCERTAINTY

The following measurement uncertainty levels have been estimated for tests performed on the apparatus:

Parameter	Uncertainty
Radio Frequency	$\pm 1 \times 10^{-5}$
Maximum Peak Output Power Test	$\pm 1.0\text{dB}$
Conducted Emissions Test	$\pm 2.0\text{dB}$
Radiated Emission Test	$\pm 2.0\text{dB}$
Power Density	$\pm 2.0\text{dB}$
Occupied Bandwidth Test	$\pm 1.0\text{dB}$
Band Edge Test	$\pm 3\text{dB}$
All emission, radiated	$\pm 3\text{dB}$
Antenna Port Emission	$\pm 3\text{dB}$
Temperature	$\pm 0.5^\circ\text{C}$
Humidity	$\pm 3\%$

Remark: The coverage Factor ( $k=2$ ), and measurement Uncertainty for a level of Confidence of 95%

## 6. Conducted Emissions Test

### 6.1 Measurement Procedure:

1. The EUT was placed on a table, which is 0.8m above ground plane.
2. Maximum procedure was performed on the six highest emissions to ensure EUT compliance.
3. Repeat above procedures until all frequency measured was complete.

### 6.2 Test SET-UP (Block Diagram of Configuration)

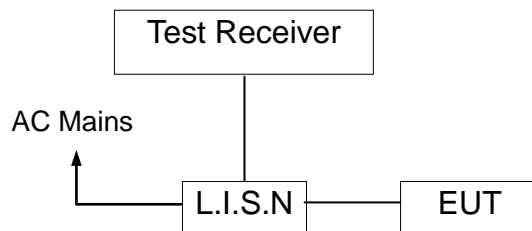

### 6.3 Measurement Equipment Used:

EQUIPMENT TYPE	MFR	MODEL NUMBER	SERIAL NUMBER	Calibrated until
L.I.S.N	SCHWARZBECK	NSLK 8127	8127-669	2022-05-23
10 db attenuator	JFW	50FP-010-H4	4360846-427-1	2022-05-23
RF Cable	N/A	N/A	2#	2022-05-23
EMI Test Receiver	ROHDE&SCHWARZ	ESCI	101358	2022-05-23



#### **6.4 Measurement Result:**

Operation Mode:	TX	Test Date :	2021-07-07
Frequency Range:	0.15MHz~30MHz	Temperature :	24°C
Test Result:	PASS	Humidity :	58 %
Test By:	Best		

Pass.

Conducted emission at both 120V & 240V, and emission at 120V represents the worst case. All the modulation modes were tested the data of the worst mode are recorded in the following pages and the others modulation methods do not exceed the limits.

Please refer to the following data.

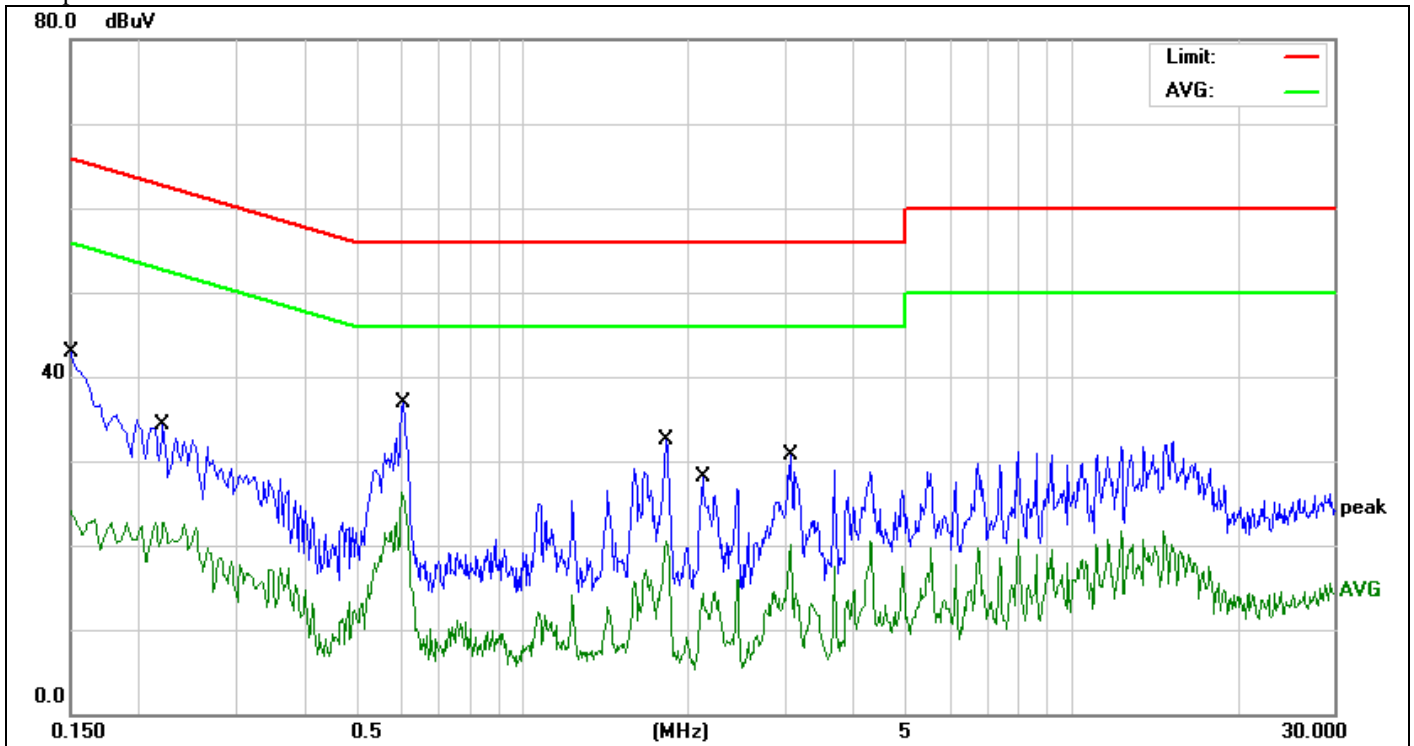

Site:	843.3	Phase:N	Temperature(C):26(C)
Limit:	FCC Part 15 C Conduction(QP)	Test Time:	Humidity(%):60%
EUT:	White Daisy Shower Speaker	Power Rating:	2021-07-07
M/N.:	UO-BTSS-WHDSY	Test Engineer:	AC 120V/60Hz
Mode:	BT Mode		Bast
Note:			

No.	Frequency (MHz)	Reading Level(dBuV)	Factor (dB)	Measurement(dBuV)	Limit (dBuV)	Over (dB)	Detector	Comment
1	0.1500	26.23	10.07	36.30	65.99	-29.69	QP	
2	0.1500	13.89	10.07	23.96	55.99	-32.03	AVG	
3	0.2220	19.34	10.08	29.42	62.74	-33.32	QP	
4	0.2220	10.50	10.08	20.58	52.74	-32.16	AVG	
5	0.6060	23.17	10.10	33.27	56.00	-22.73	QP	
6 *	0.6060	16.02	10.10	26.12	46.00	-19.88	AVG	
7	1.8260	18.68	10.14	28.82	56.00	-27.18	QP	
8	1.8260	10.65	10.14	20.79	46.00	-25.21	AVG	
9	2.1300	12.66	10.15	22.81	56.00	-33.19	QP	
10	2.1300	3.80	10.15	13.95	46.00	-32.05	AVG	
11	3.0780	16.06	10.21	26.27	56.00	-29.73	QP	
12	3.0780	10.02	10.21	20.23	46.00	-25.77	AVG	

\*:Maximum data x:Over limit !:over margin

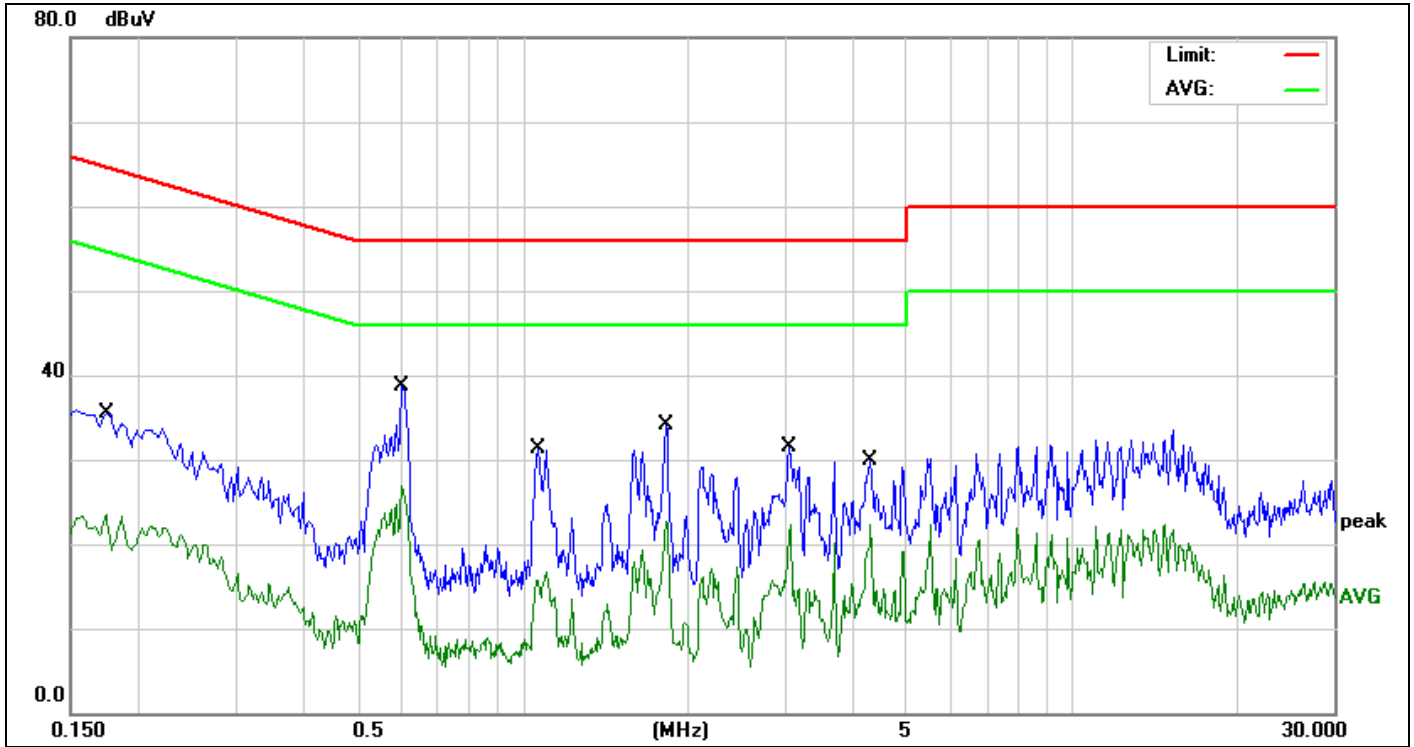

<b>Site:</b>	843.3	<b>Phase:</b> L1	<b>Temperature(C):</b> 26(C)
<b>Limit:</b>	FCC Part 15 C Conduction(QP)		<b>Humidity(%):</b> 60%
<b>EUT:</b>	White Daisy Shower Speaker	<b>Test Time:</b>	2021-07-07
<b>M/N.:</b>	UO-BTSS-WHDSY	<b>Power Rating:</b>	AC 120V/60Hz
<b>Mode:</b>	TX2402	<b>Test Engineer:</b>	Bast
<b>Note:</b>			

No.	Frequency (MHz)	Reading Level(dBuV)	Factor (dB)	Measurement(dBuV)	Limit (dBuV)	Over (dB)	Detector	Comment
1	0.1740	22.65	10.08	32.73	64.76	-32.03	QP	
2	0.1740	11.75	10.08	21.83	54.76	-32.93	AVG	
3	0.6020	24.57	10.10	34.67	56.00	-21.33	QP	
4 *	0.6020	17.09	10.10	27.19	46.00	-18.81	AVG	
5	1.0660	13.32	10.10	23.42	56.00	-32.58	QP	
6	1.0660	4.30	10.10	14.40	46.00	-31.60	AVG	
7	1.8260	20.21	10.14	30.35	56.00	-25.65	QP	
8	1.8260	12.19	10.14	22.33	46.00	-23.67	AVG	
9	3.0500	17.03	10.20	27.23	56.00	-28.77	QP	
10	3.0500	9.13	10.20	19.33	46.00	-26.67	AVG	
11	4.3020	13.86	10.28	24.14	56.00	-31.86	QP	
12	4.3020	9.81	10.28	20.09	46.00	-25.91	AVG	

\*:Maximum data x:Over limit !:over margin



### 6.5 Conducted Measurement Photos:

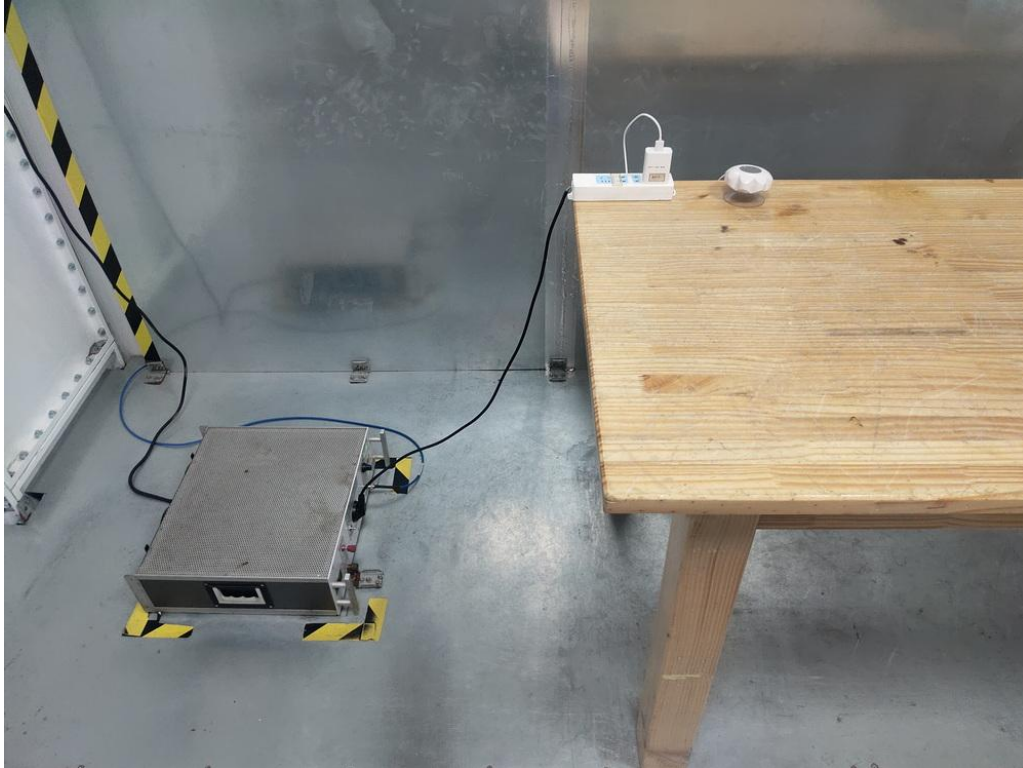

## 7. Radiated Emission Test

### 7.1 Measurement Procedure

1. The testing follows the guidelines in Spurious Radiated Emissions of ANSI C63.10-2013.
2. Below 1000MHz, The EUT was placed on a turn table which is 0.8m above ground plane. And above 1000MHz, The EUT was placed on a styrofoam table which is 1.5m above ground plane.
3. The EUT was set 3 meters from the interference receiving antenna, which was mounted on the top of a variable height antenna tower.
4. For each suspected emission, the EUT was arranged to its worst case and then tune the Antenna tower (From 1m to 4m) and turntable (from 0 degree to 360 degree) to find the maximum reading. A pre-amp and a high pass filter are used for the test in order to get better signal level to comply with the guidelines.
5. Set to the maximum power setting and enable the EUT transmit continuously.
6. Final measurement (Above 1GHz): The frequency range will be divided into different sub ranges depending of the frequency range of the used horn antenna. The EMI Receiver set to peak and average mode and a resolution bandwidth of 1MHz. The measurement will be performed in horizontal and vertical polarization of the measuring antenna and while rotating the EUT in its vertical axis in the range of 0 degree to 360 degree in order to have the antenna inside the cone of radiation.
7. Test Procedure of measurement (For Above 1GHz):
  - 1) Monitor the frequency range at horizontal polarization and move the antenna over all sides of the EUT(if necessary move the EUT to another orthogonal axis).
  - 2) Change the antenna polarization and repeat 1) with vertical polarization.
  - 3) Make a hardcopy of the spectrum.
  - 4) Measure the frequency of the detected emissions with a lower span and resolution bandwidth to increase the accuracy and note the frequency value.
  - 5) Change the analyser mode to Clear/ Write and found the cone of emission.
  - 6) Rotate and move the EUT, so that the measuring distance can be enlarged to 3m and the antenna will be still inside the cone of emission.
  - 7) Measure the level of the detected frequency with the correct resolution bandwidth, with the antenna polarization and azimuth and the peak and average detector, which causes the maximum emission.
  - 8) Repeat steps 1) to 7) for the next antenna spot if the EUT is larger than the antenna beamwidth.



Use the following spectrum analyzer settings:

When spectrum scanned from 30MHz to 1GHz setting resolution bandwidth 120KHz and video bandwidth 300KHz:

EMI Test Receiver	Setting
Attenuation	Auto
RB	120KHz
VB	300KHz
Detector	QP
Trace	Max hold

When spectrum scanned above 1GHz setting resolution bandwidth 1MHz, video bandwidth 3MHz:

EMI Test Receiver	Setting
Attenuation	Auto
RB	1MHz
VB	3MHz
Detector	Peak
Trace	Max hold

When spectrum scanned above 1GHz setting resolution bandwidth 1MHz, video bandwidth 10Hz:

EMI Test Receiver	Setting
Attenuation	Auto
RB	1MHz
VB	10Hz
Detector	Average
Trace	Max hold

## 7.2 Test SET-UP (Block Diagram of Configuration)

(A) Radiated Emission Test Set-Up, Frequency Below 30MHz

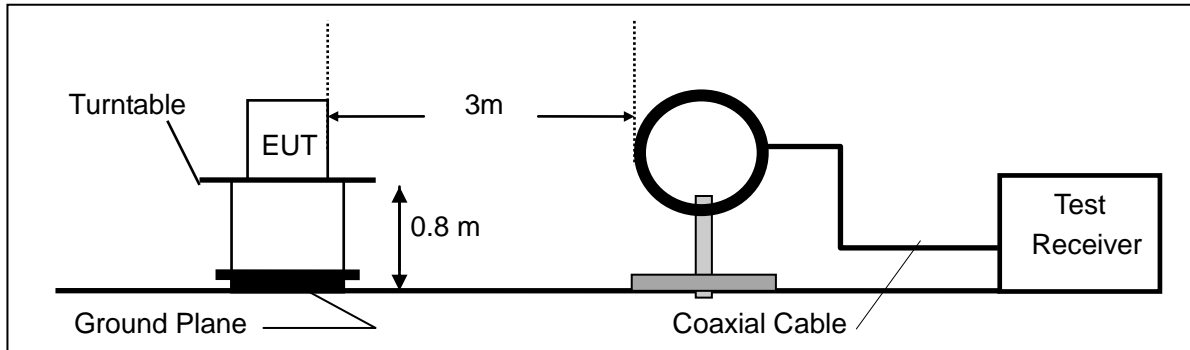

(B) Radiated Emission Test Set-Up, Frequency Below 1000MHz

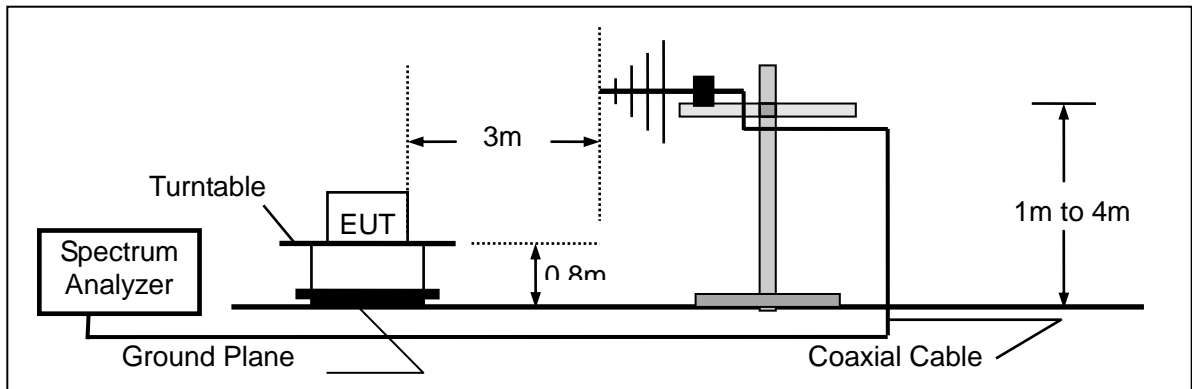

(C) Radiated Emission Test Set-Up, Frequency above 1000MHz

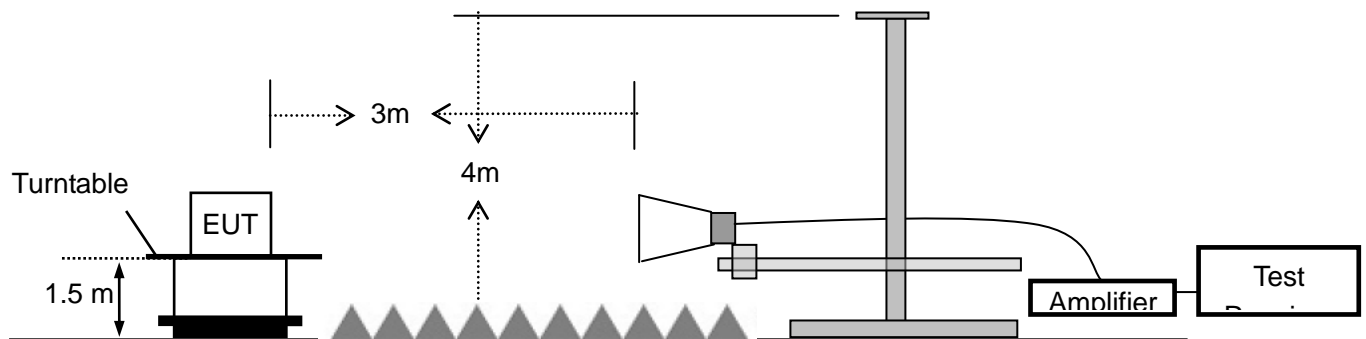

### 7.3 Measurement Equipment Used:

Item	Equipment	Manufacturer	Model No.	Serial No.	Calibrated until
1.	EMI Test Receiver	Rohde & Schwarz	ESPI	100502	2021-11-19
2.	Pre-Amplifier	HP	8447D	2727A06172	2022-05-23
3.	Bilog Antenna	Schwarzbeck	VULB9163	VULB9163-588	2022-05-23
4.	Loop Antenna	Schwarzbeck	FMZB 1516	1516-141	2021-11-19
5.	Spectrum Analyzer	Rohde & Schwarz	FSV40	US40240623	2021-11-19
6.	Low noise Amplifiers	A-INFO	LA1018N4009	J101313052400 1	2022-05-23
7.	Horn antenna	A-INFO	LB-10180-SF	J203109061212 3	2022-05-23
8.	Broadband RF Power Amplifier	AEROFLEX	AEROFLEX10 0KHz-40GHz	J101313052400 1	2021-11-19
9.	DRG Horn Antenna	A.H.SYSTEMS	SAS-574	J203109061212 3	2021-11-19
10.	RF Cable	Gigalink Microwave	ZT40-2.92J-2. 92J-2m	N/A	2021-11-19
11.	RF Cable	Gigalink Microwave	ZT40-2.92J-2. 92J-0.3m	N/A	2021-11-19
12.	RF Cable	N/A	N/A	6#	2022-05-23
13.	RF Cable	N/A	N/A	1-1#	2022-05-23
14.	RF Cable	N/A	N/A	1-2#	2022-05-23
15.	RF Cable	N/A	N/A	7#	2022-05-23
16.	3m Semi-anechoic Chamber	chengyu	9m*6m*6m	N/A	2022-05-23
17.	Test Software	Farad	EZ-EMC Ver:ANCI-3A1	N/A	N/A

### 7.4 Radiated Emission Limit

The emissions from an intentional radiator shall not exceed the field strength levels specified in the following table 15.209(a):

Frequencies (MHz)	Field Strength (micровolts/meter)	Measurement Distance (meters)
0.009~0.490	2400/F(KHz)	300
0.490~1.705	24000/F(KHz)	30
1.705~30.0	30	30
30~88	100	3
88~216	150	3
216~960	200	3
Above 960	500	3

### 15.205 Restricted bands of operation

MHz	MHz	MHz	GHz
0.090 - 0.110	16.42 - 16.423	399.9 - 410	4.5 - 5.15
<sup>1</sup> 0.495 - 0.505	16.69475 - 16.69525	608 - 614	5.35 - 5.46
2.1735 - 2.1905	16.80425 - 16.80475	960 - 1240	7.25 - 7.75
4.125 - 4.128	25.5 - 25.67	1300 - 1427	8.025 - 8.5
4.17725 - 4.17775	37.5 - 38.25	1435 - 1626.5	9.0 - 9.2
4.20725 - 4.20775	73 - 74.6	1645.5 - 1646.5	9.3 - 9.5
6.215 - 6.218	74.8 - 75.2	1660 - 1710	10.6 - 12.7
6.26775 - 6.26825	108 - 121.94	1718.8 - 1722.2	13.25 - 13.4
6.31175 - 6.31225	123 - 138	2200 - 2300	14.47 - 14.5
8.291 - 8.294	149.9 - 150.05	2310 - 2390	15.35 - 16.2
8.362 - 8.366	156.52475 - 156.52525	2483.5 - 2500	17.7 - 21.4
8.37625 - 8.38675	156.7 - 156.9	2690 - 2900	22.01 - 23.12
8.41425 - 8.41475	162.0125 - 167.17	3260 - 3267	23.6 - 24.0
12.29 - 12.293	167.72 - 173.2	3332 - 3339	31.2 - 31.8
12.51975 - 12.52025	240 - 285	3345.8 - 3358	36.43 - 36.5
12.57675 - 12.57725	322 - 335.4	3600 - 4400	(3)

- Remark 1. Emission level in dBuV/m=20 log (uV/m)
- : 2. Measurement was performed at an antenna to the closed point of EUT distance of meters.
3. Only spurious frequency is permitted to locate within the Restricted Bands specified in provision of § 15.205, and the emissions located in restricted bands also comply with 15.209 limit.



### 7.5 Measurement Result

Operation Mode:	TX	Test Date :	2021-07-07
Test By:	Best	Temperature :	25°C
Test Result:	PASS	Humidity :	58 %
Measured Distance:	3m		

#### Below 30MHz:

Freq. (MHz)	Ant.Pol. H/V	Emission Level (dBuV/m)	Limit 3m (dBuV/m)	Over (dB)
--	--	--	--	--

Note: The low frequency, which started from 9KHz-30MHz, was pre-scanned and the result which was 20dB lower than the limit line per 15.31(o) was not reported.

#### Below 1000MHz:

Pass.

All the modulation modes were tested the data of the worst mode (8DPSK TX 2402MHz) are recorded in the following pages and the others modulation methods do not exceed the limits.

Please refer to the following data.

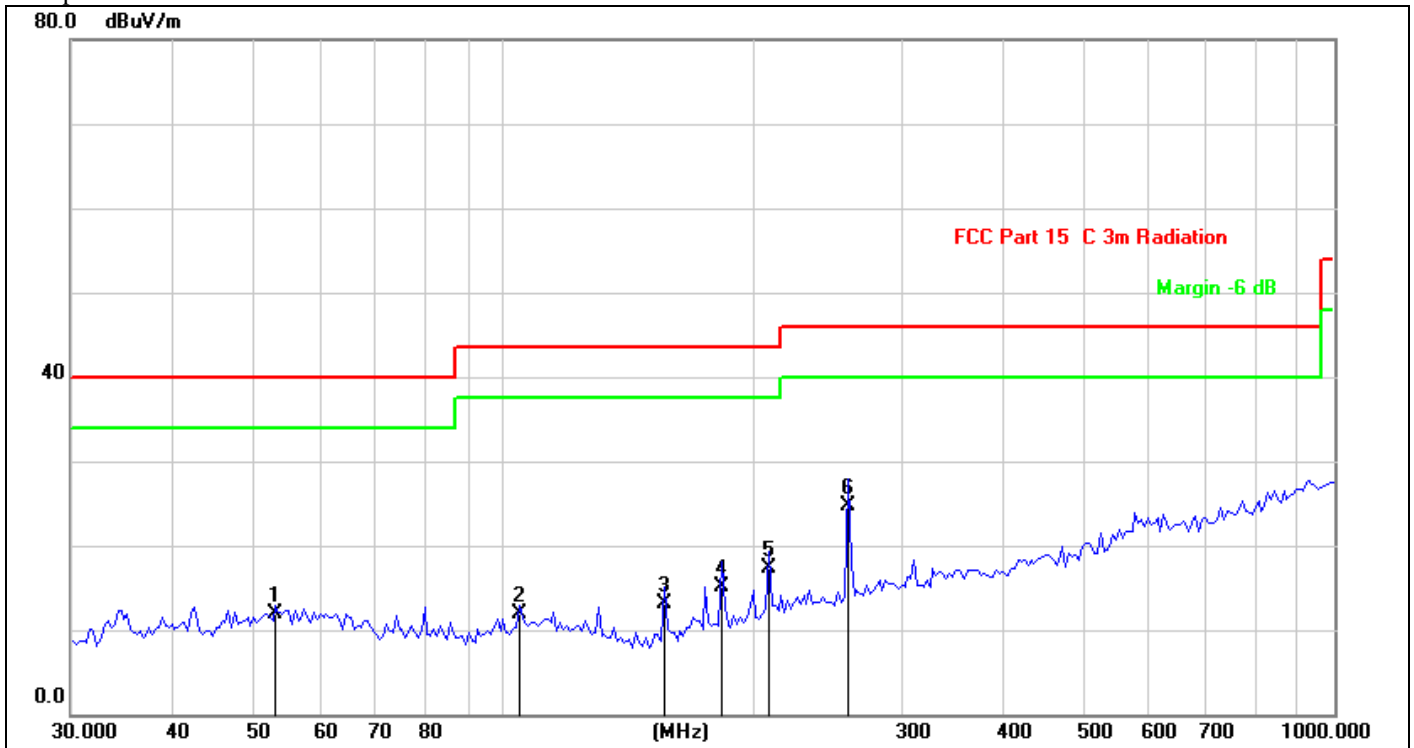

Site:	LAB	Antenna::	Horizontal	Temperature(C):	26(C)
Limit:	FCC Part 15 C 3m Radiation			Humidity(%):	60%
EUT:	White Daisy Shower Speaker	Test Time:		2021-07-07	
M/N.:	UO-BTSS-WHDSY	Power Rating:		Battery 3.7V	
Mode:	TX2402	Test Engineer:		Bast	
Note:					

No.	Frequency (MHz)	Reading (dBuV)	Factor (dB/m)	Level (dBuV/m)	Limit (dBuV/m)	Margin (dB)	Det.	Height (cm)	Azimuth (deg)	Remark
1	53.0382	27.78	-15.93	11.85	40.00	-28.15	QP			
2	104.1701	28.86	-16.91	11.95	43.50	-31.55	QP			
3	155.9101	31.60	-18.48	13.12	43.50	-30.38	QP			
4	182.5592	32.49	-17.33	15.16	43.50	-28.34	QP			
5	208.2148	33.24	-15.92	17.32	43.50	-26.18	QP			
6 *	259.2338	38.96	-14.16	24.80	46.00	-21.20	QP			

\*:Maximum data x:Over limit !:over margin



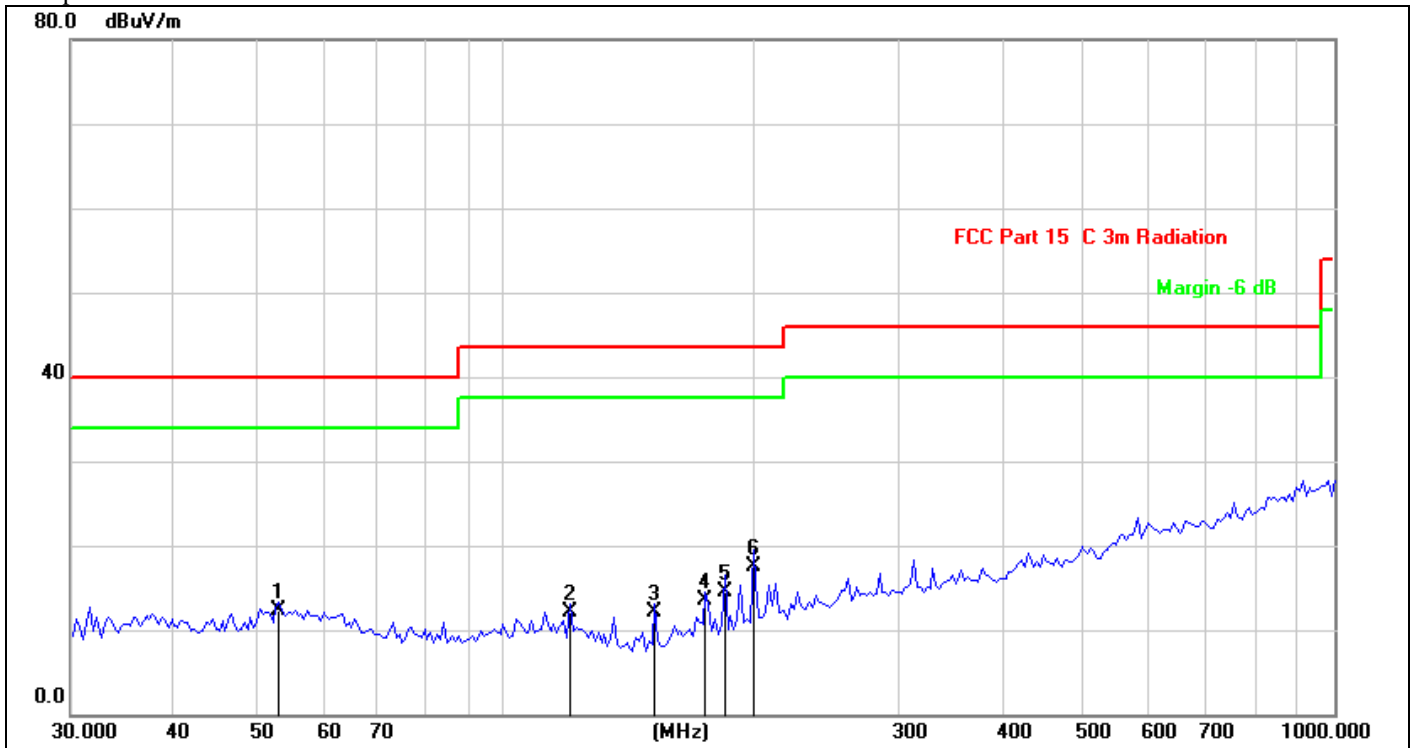

Site:	LAB	Antenna::	Vertical	Temperature(C):	26(C)
Limit:	FCC Part 15 C 3m Radiation	Test Time:		Humidity(%):	60%
EUT:	White Daisy Shower Speaker	Power Rating:		Battery	3.7V
M/N.:	UO-BTSS-WHDSY	Test Engineer:		AC	120V/60Hz
Mode:	TX2402			Bast	
Note:					

No.	Frequency (MHz)	Reading (dBuV)	Factor (dB/m)	Level (dBuV/m)	Limit (dBuV/m)	Margin (dB)	Det.	Height (cm)	Azimuth (deg)	Remark
1	53.5052	28.27	-15.93	12.34	40.00	-27.66	QP			
2	119.8556	29.24	-17.16	12.08	43.50	-31.42	QP			
3	151.8632	30.87	-18.72	12.15	43.50	-31.35	QP			
4	174.7301	31.12	-17.57	13.55	43.50	-29.95	QP			
5	184.1667	31.82	-17.24	14.58	43.50	-28.92	QP			
6 *	199.2855	33.94	-16.37	17.57	43.50	-25.93	QP			

\*:Maximum data x:Over limit !:over margin

**Above 1000MHz~10<sup>th</sup> Harmonics:**

Please refer to the following data.

Operation Mode: GFSK (CH1: 2402MHz) Test Date : 2021-07-07

Freq. (MHz)	Ant. Pol.	Reading Level(dBuV/m)		Correct Factor dB	Emission Level(dBuV/m)		Limit 3m(dBuV/m)		Margin(dB)	
		PK	AV		PK	AV	PK	AV	PK	AV
4804	V	95.35	76.15	-32.3	63.05	43.85	74	54	-10.95	-10.15
7206	V	97.39	77.4	-37.25	60.14	40.15	74	54	-13.86	-13.85
9608	V	98.12	79.42	-39.8	58.32	39.62	74	54	-15.68	-14.38
12010	V	97.82	79.15	-40.5	57.32	38.65	74	54	-16.68	-15.35
14412	V	98.03	78.88	-41.7	56.33	37.18	74	54	-17.67	-16.82
16814	V	95.17	76.58	-40	55.17	36.58	74	54	-18.83	-17.42
4804	H	94.38	74.98	-31.4	62.98	43.58	74	54	-11.02	-10.42
7206	H	94.86	75.75	-35.5	59.36	40.25	74	54	-14.64	-13.75
9608	H	96.42	77.95	-38.3	58.12	39.65	74	54	-15.88	-14.35
12010	H	96.69	77.74	-39	57.69	38.74	74	54	-16.31	-15.26
14412	H	98.32	79.52	-42	56.32	37.52	74	54	-17.68	-16.48
16814	H	94.77	76.15	-39.3	55.47	36.85	74	54	-18.53	-17.15

Operation Mode: GFSK (CH40: 2441MHz) Test Date : 2021-07-07

Freq. (MHz)	Ant. Pol.	Reading Level(dBuV/m)		Correct Factor dB	Emission Level(dBuV/m)		Limit 3m(dBuV/m)		Margin(dB)	
		PK	AV		PK	AV	PK	AV	PK	AV
4882	V	96.04	76.32	-32.3	63.74	44.02	74	54	-10.26	-9.98
7323	V	97.45	78.23	-37.2	60.25	41.03	74	54	-13.75	-12.97
9764	V	98.76	79.96	-39.6	59.16	40.36	74	54	-14.84	-13.64
12205	V	98.16	78.97	-40.5	57.66	38.47	74	54	-16.34	-15.53
14646	V	97.25	78.65	-41	56.25	37.65	74	54	-17.75	-16.35
17087	V	96.24	77.68	-41.1	55.14	36.58	74	54	-18.86	-17.42
4882	H	95.16	75.29	-31.6	63.56	43.69	74	54	-10.44	-10.31
7323	H	95.96	76.92	-35.7	60.26	41.22	74	54	-13.74	-12.78
9764	H	97.66	78.45	-38.3	59.36	40.15	74	54	-14.64	-13.85
12205	H	96.32	77.69	-39	57.32	38.69	74	54	-16.68	-15.31
14646	H	98.31	79.25	-42	56.31	37.25	74	54	-17.69	-16.75
17087	H	96.69	78.08	-41.5	55.19	36.58	74	54	-18.81	-17.42



Operation Mode: GFSK (CH79: 2480MHz) Test Date : 2021-07-07

Freq. (MHz)	Ant. Pol. H/V	Reading Level(dBuV/m)		Correct Factor dB	Emission Level(dBuV/m)		Limit 3m(dBuV/m)		Margin(dB)	
		PK	AV		PK	AV	PK	AV	PK	AV
4960	V	96.53	77.5	-32.3	64.23	45.2	74	54	-9.77	-8.8
7440	V	98.59	79.31	-37.2	61.39	42.11	74	54	-12.61	-11.89
9920	V	98.96	80.23	-39.6	59.36	40.63	74	54	-14.64	-13.37
12400	V	98.32	79.22	-40.7	57.62	38.52	74	54	-16.38	-15.48
14880	V	97.33	78.19	-41	56.33	37.19	74	54	-17.67	-16.81
17360	V	97.57	78.35	-41.1	56.47	37.25	74	54	-17.53	-16.75
4960	H	96.18	75.96	-31.6	64.58	44.36	74	54	-9.42	-9.64
7440	H	96.55	76.83	-35.7	60.85	41.13	74	54	-13.15	-12.87
9920	H	97.13	78.42	-38.1	59.03	40.32	74	54	-14.97	-13.68
12400	H	96.23	77.16	-39	57.23	38.16	74	54	-16.77	-15.84
14880	H	98.32	79.84	-42	56.32	37.84	74	54	-17.68	-16.16
17360	H	97.21	77.74	-41.5	55.71	36.24	74	54	-18.29	-17.76

Operation Mode: Pi/4-DQPSK (CH1: 2402MHz) Test Date : 2021-07-07

Freq. (MHz)	Ant. Pol. H/V	Reading Level(dBuV/m)		Correct Factor dB	Emission Level(dBuV/m)		Limit 3m(dBuV/m)		Over(dB)	
		PK	AV		PK	AV	PK	AV	PK	AV
4804	V	94.28	74.88	-32.3	61.98	42.58	74	54	-12.02	-11.42
7206	V	97.52	78.47	-37.2	60.32	41.27	74	54	-13.68	-12.73
9608	V	98.12	79.58	-39.8	58.32	39.78	74	54	-15.68	-14.22
12010	V	97.08	77.95	-40.5	56.58	37.45	74	54	-17.42	-16.55
14412	V	98.02	79.02	-41.7	56.32	37.32	74	54	-17.68	-16.68
16814	V	96.47	77.56	-40	56.47	37.56	74	54	-17.53	-16.44
4804	H	93.18	73.92	-31.6	61.58	42.32	74	54	-12.42	-11.68
7206	H	95.65	76.86	-35.5	60.15	41.36	74	54	-13.85	-12.64
9608	H	96.72	77.71	-38.3	58.42	39.41	74	54	-15.58	-14.59
12010	H	96.92	77.74	-39.4	57.52	38.34	74	54	-16.48	-15.66
14412	H	98.41	79.21	-42	56.41	37.21	74	54	-17.59	-16.79
16814	H	95.33	76.47	-39.3	56.03	37.17	74	54	-17.97	-16.83



Freq. (MHz)	Ant. Pol. H/V	Reading Level(dBuV/m)		Correct Factor dB	Emission Level(dBuV/m)		Limit 3m(dBuV/m)		Over(dB)	
		PK	AV		PK	AV	PK	AV	PK	AV
4882	V	95.21	75.55	-32.3	62.91	43.25	74	54	-11.09	-10.75
7323	V	97.45	78.85	-37.2	60.25	41.65	74	54	-13.75	-12.35
9764	V	98.46	79.07	-39.8	58.66	39.27	74	54	-15.34	-14.73
12205	V	97.08	78.08	-40.5	56.58	37.58	74	54	-17.42	-16.42
14646	V	97.32	78.25	-41	56.32	37.25	74	54	-17.68	-16.75
17087	V	97.28	78.12	-41.1	56.18	37.02	74	54	-17.82	-16.98
4882	H	94.07	74.62	-31.6	62.47	43.02	74	54	-11.53	-10.98
7323	H	95.48	76.08	-35.5	59.98	40.58	74	54	-14.02	-13.42
9764	H	96.26	77.12	-38.3	57.96	38.82	74	54	-16.04	-15.18
12205	H	95.88	76.25	-39	56.88	37.25	74	54	-17.12	-16.75
14646	H	98.32	79.02	-42	56.32	37.02	74	54	-17.68	-16.98
17087	H	97.88	78.65	-41.4	56.48	37.25	74	54	-17.52	-16.75

Operation Mode: Pi/4-DQPSK (CH79: 2480MHz) Test Date : 2021-07-07

Freq. (MHz)	Ant. Pol. H/V	Reading Level(dBuV/m)		Correct Factor dB	Emission Level(dBuV/m)		Limit 3m(dBuV/m)		Over(dB)	
		PK	AV		PK	AV	PK	AV	PK	AV
4960	V	95.32	76.47	-32.3	63.02	44.17	74	54	-10.98	-9.83
7440	V	98.78	79.42	-37.2	61.58	42.22	74	54	-12.42	-11.78
9920	V	99.43	79.95	-39.8	59.63	40.15	74	54	-14.37	-13.85
12400	V	98.02	79.08	-40.5	57.52	38.58	74	54	-16.48	-15.42
14880	V	97.47	78.33	-41	56.47	37.33	74	54	-17.53	-16.67
17360	V	96.78	77.68	-41.1	55.68	36.58	74	54	-18.32	-17.42
4960	H	94.73	75.66	-31.6	63.13	44.06	74	54	-10.87	-9.94
7440	H	96.75	78.08	-35.5	61.25	42.58	74	54	-12.75	-11.42
9920	H	97.88	78.5	-38.3	59.58	40.2	74	54	-14.42	-13.8
12400	H	96.48	77.58	-39	57.48	38.58	74	54	-16.52	-15.42
14880	H	98.32	79.16	-42	56.32	37.16	74	54	-17.68	-16.84
17360	H	97.83	78.52	-41.5	56.33	37.02	74	54	-17.67	-16.98



Report No.: EA21070082F01001

29 of 78

Operation Mode: 8DPSK (CH1: 2402MHz) Test Date : 2021-07-07

Freq. (MHz)	Ant. Pol. H/V	Reading Level(dBuV/m)		Correct Factor dB	Emission Level(dBuV/m)		Limit 3m(dBuV/m)		Over(dB)	
		PK	AV		PK	AV	PK	AV	PK	AV
4804	V	94.6	75.52	-32.3	62.3	43.22	74	54	-11.7	-10.8
7206	V	97.53	78.89	-37.2	60.33	41.69	74	54	-13.67	-12.3
9608	V	99.27	80.05	-39.8	59.47	40.25	74	54	-14.53	-13.8
12010	V	98.86	80.08	-40.5	58.36	39.58	74	54	-15.64	-14.4
14412	V	98.28	79.11	-41.7	56.58	37.41	74	54	-17.42	-16.6
16814	V	95.71	76.58	-40	55.71	36.58	74	54	-18.29	-17.4
4804	H	93.75	74.67	-31.6	62.15	43.07	74	54	-11.85	-10.9
7206	H	95.83	77	-35.5	60.33	41.5	74	54	-13.67	-12.5
9608	H	97.66	78.82	-38.3	59.36	40.52	74	54	-14.64	-13.5
12010	H	97.17	78.45	-39	58.17	39.45	74	54	-15.83	-14.6
14412	H	98.47	79.58	-42	56.47	37.58	74	54	-17.53	-16.4
16814	H	94.66	75.88	-39.3	55.36	36.58	74	54	-18.64	-17.4

Operation Mode: 8DPSK (CH40: 2441MHz) Test Date : 2021-07-07

Freq. (MHz)	Ant. Pol. H/V	Reading Level(dBuV/m)		Correct Factor dB	Emission Level(dBuV/m)		Limit 3m(dBuV/m)		Over(dB)	
		PK	AV		PK	AV	PK	AV	PK	AV
4882	V	95.32	76.55	-32.3	63.02	44.25	74	54	-10.98	-9.75
7323	V	98.52	79.22	-37.2	61.32	42.02	74	54	-12.68	-11.98
9764	V	99.13	80.05	-39.8	59.33	40.25	74	54	-14.67	-13.75
12205	V	98.82	79.66	-40.5	58.32	39.16	74	54	-15.68	-14.84
14646	V	98.25	79.02	-41	57.25	38.02	74	54	-16.75	-15.98
17087	V	97.27	78.24	-41.1	56.17	37.14	74	54	-17.83	-16.86
4882	H	94.71	75.56	-31.6	63.11	43.96	74	54	-10.89	-10.04
7323	H	96.86	78.19	-35.5	61.36	42.69	74	54	-12.64	-11.31
9764	H	97.71	78.69	-38.3	59.41	40.39	74	54	-14.59	-13.61
12205	H	97.31	78.81	-39	58.31	39.81	74	54	-15.69	-14.19
14646	H	98.32	79.14	-42	56.32	37.14	74	54	-17.68	-16.86
17087	H	98.05	79.12	-41.5	56.55	37.62	74	54	-17.45	-16.38



Freq. (MHz)	Ant. Pol.	Reading Level(dBuV/m)		Correct Factor dB	Emission Level(dBuV/m)		Limit 3m(dBuV/m)		Over(dB)	
		PK	AV		PK	AV	PK	AV	PK	AV
4960	V	96.55	77.62	-32.3	64.25	45.32	74	54	-9.75	-8.68
7440	V	99.53	80.22	-37.2	62.33	43.02	74	54	-11.67	-10.98
9920	V	100.27	81.54	-39.8	60.47	41.74	74	54	-13.53	-12.26
12400	V	99.86	80.65	-40.5	59.36	40.15	74	54	-14.64	-13.85
14880	V	99.22	80.13	-41	58.22	39.13	74	54	-15.78	-14.87
17360	V	97.73	78.68	-41.1	56.63	37.58	74	54	-17.37	-16.42
4960	H	95.83	76.39	-31.6	64.23	44.79	74	54	-9.77	-9.21
7440	H	97.53	77.72	-35.5	62.03	42.22	74	54	-11.97	-11.78
9920	H	97.98	78.55	-38.3	59.68	40.25	74	54	-14.32	-13.75
12400	H	97.74	78.78	-39	58.74	39.78	74	54	-15.26	-14.22
14880	H	99.52	80.16	-42	57.52	38.16	74	54	-16.48	-15.84
17360	H	97.82	77.97	-41.5	56.32	36.47	74	54	-17.68	-17.53

Other harmonics emissions are lower than 20dB below the allowable limit.

- Note:**
- (1) All Readings are Peak Value and AV.
  - (2) Emission Level= Reading Level+ Probe Factor +Cable Loss.
  - (3) The average measurement was not performed when the peak measured data under the limit of average detection.
  - (4) Measuring frequencies from 1GHz to 25GHz.

**7.5 Radiated Measurement Photos:**





## 8. Channel Separation test

### 8.1 Measurement Procedure

The EUT was operating in hopping mode or could be controlled its channel. Printed out the test result from the spectrum by hard copy function.

### 8.2 Test SET-UP (Block Diagram of Configuration)

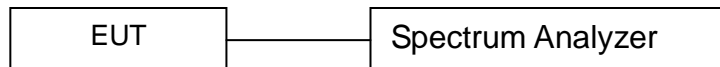

### 8.3 Measurement Equipment Used:

EQUIPMENT TYPE	MFR	MODEL NUMBER	SERIAL NUMBER	CALIBRATED UNTIL
Spectrum Analyzer	Rohde & Schwarz	FSV40	US40240623	2021-11-19
Coaxial Cable	Gigalink Microwave	ZT40	19022092	2021-11-19
Antenna Connector	ARTHUR-YANG	2244-N1TG1	N/A	2021-11-19

Remark: The temporary antenna connector is soldered on the PCB board in order to perform conducted tests and this temporary antenna connector is listed in the equipment list.

### 8.4 Measurement Results:

Refer to attached data chart.



Spectrum Detector:	PK	Test Date :	July 09, 2021
Test By:	Best	Temperature :	24°C
Test Result:	PASS	Humidity :	53 %
Modulation:	GFSK		

Channel number	Channel frequency (MHz)	Separation Read Value (kHz)	Separation Limit 20dB Down BW(kHz)
1	2402	1001	>942
40	2441	1001	>946
79	2480	1001	>945

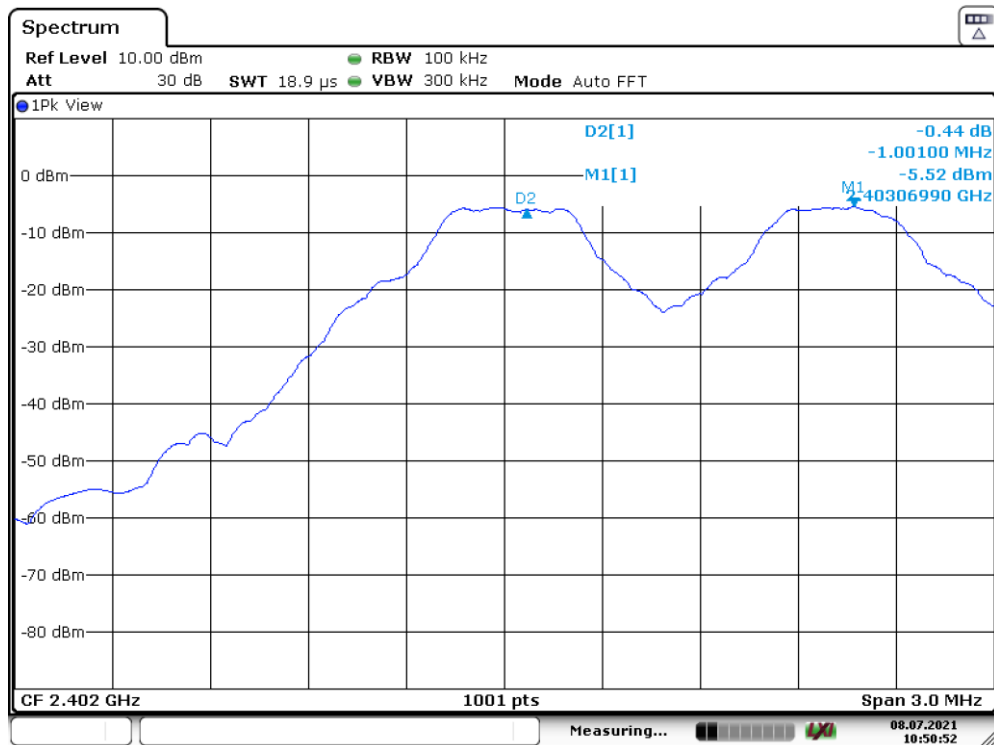

Date: 8.JUL.2021 10:50:51

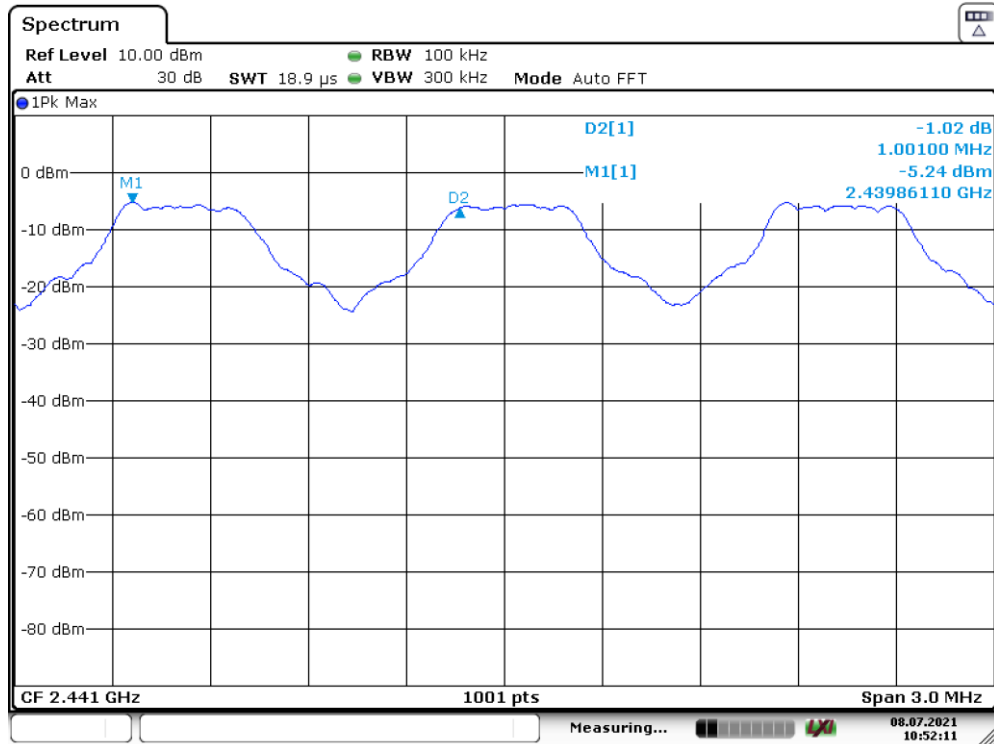

Date: 8.JUL.2021 10:52:10

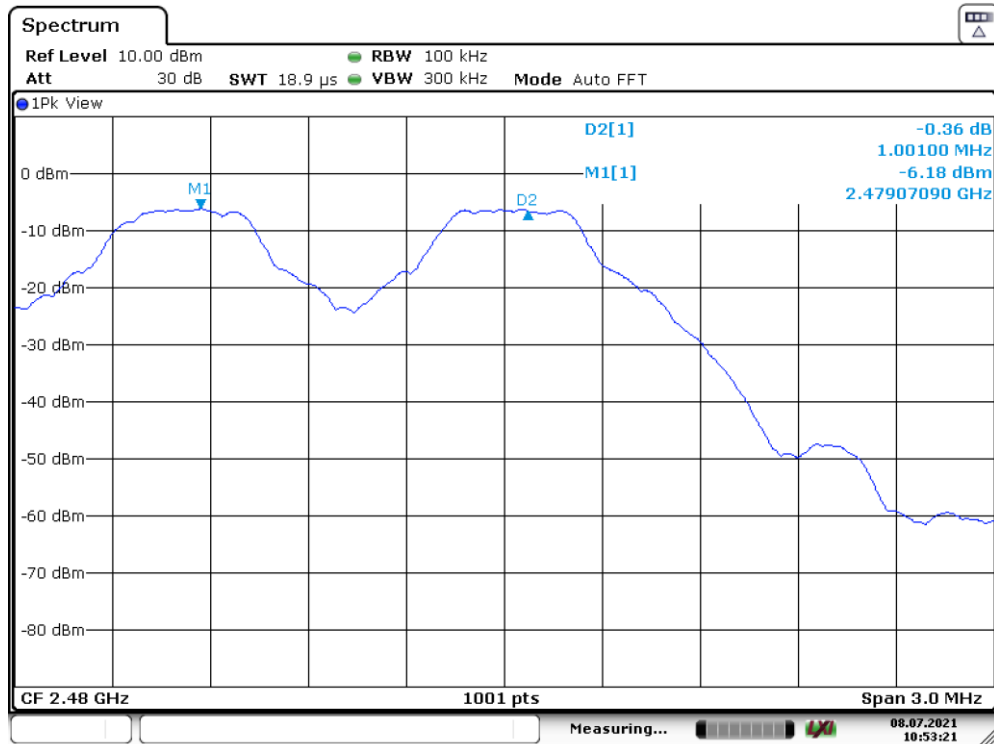

Date: 8.JUL.2021 10:53:20

Spectrum Detector:	PK	Test Date :	July 09, 2021
Test By:	Best	Temperature :	24°C
Test Result:	PASS	Humidity :	53 %
Modulation:	Π/4-DQPSK		

Channel number	Channel frequency (MHz)	Separation Read Value (kHz)	Separation Limit 2/3 20dB Down BW(kHz)
1	2402	1001	>874
40	2441	1003	>876
79	2480	1001	>875

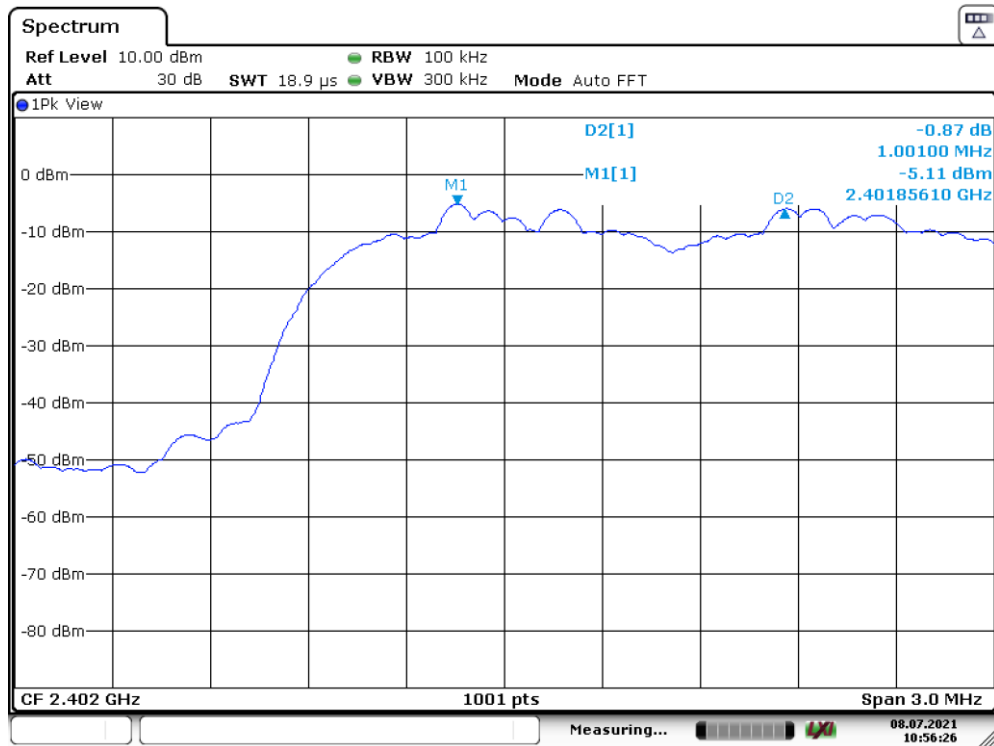

Date: 8.JUL.2021 10:56:25

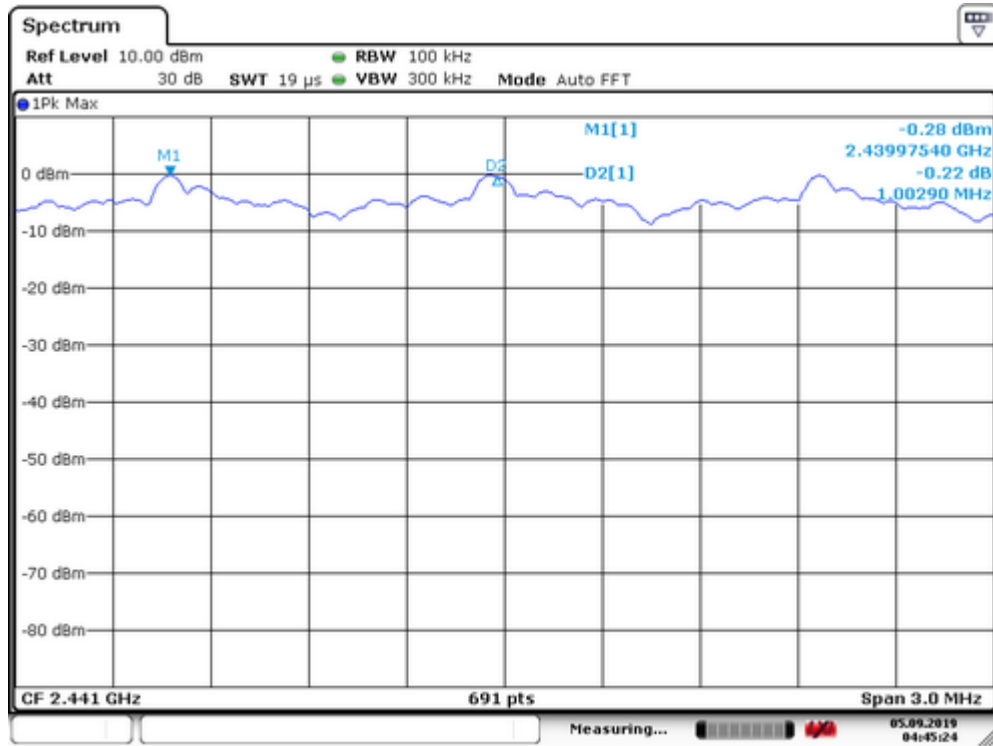

Date: 5.SEP.2019 04:45:25

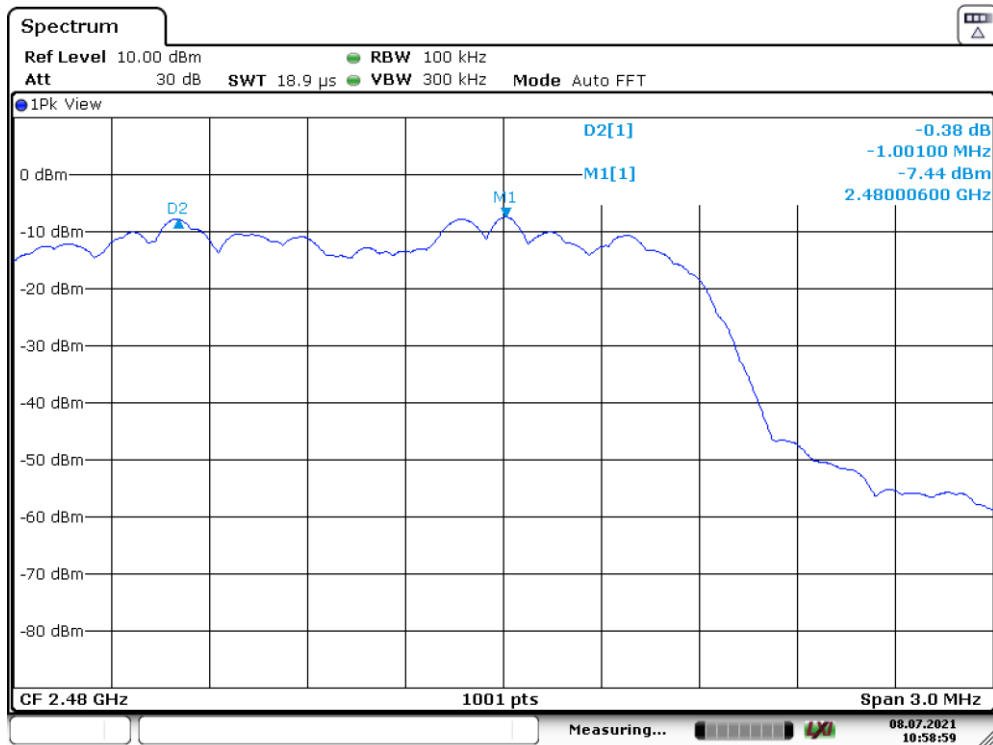

Date: 8.JUL.2021 10:58:59

Report No.: EA21070082F01001

37 of 78

Spectrum Detector: PK  
 Test By: Best  
 Test Result: PASS  
 Modulation: 8DPSK

Test Date : July 09, 2021  
 Temperature : 24°C  
 Humidity : 53 %

Channel number	Channel frequency (MHz)	Separation Read Value (kHz)	Separation Limit 2/3 20dB Down BW(kHz)
1	2402	1001	>863
40	2441	1001	>853
79	2480	1001	>869

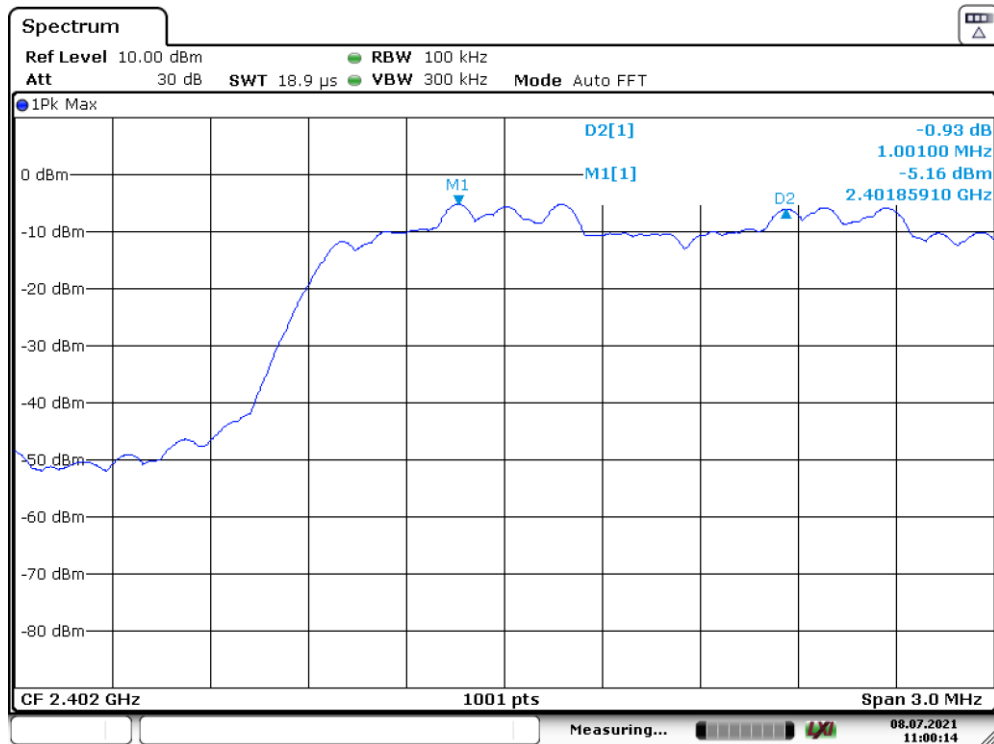

Date: 8.JUL.2021 11:00:14

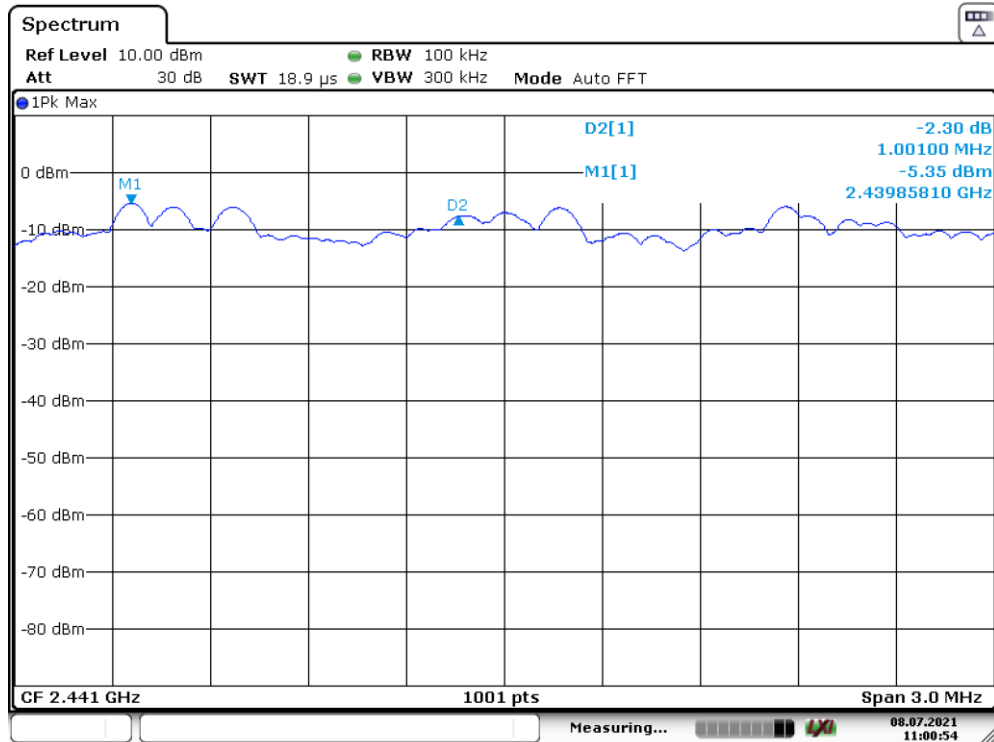

Date: 8.JUL.2021 11:00:53

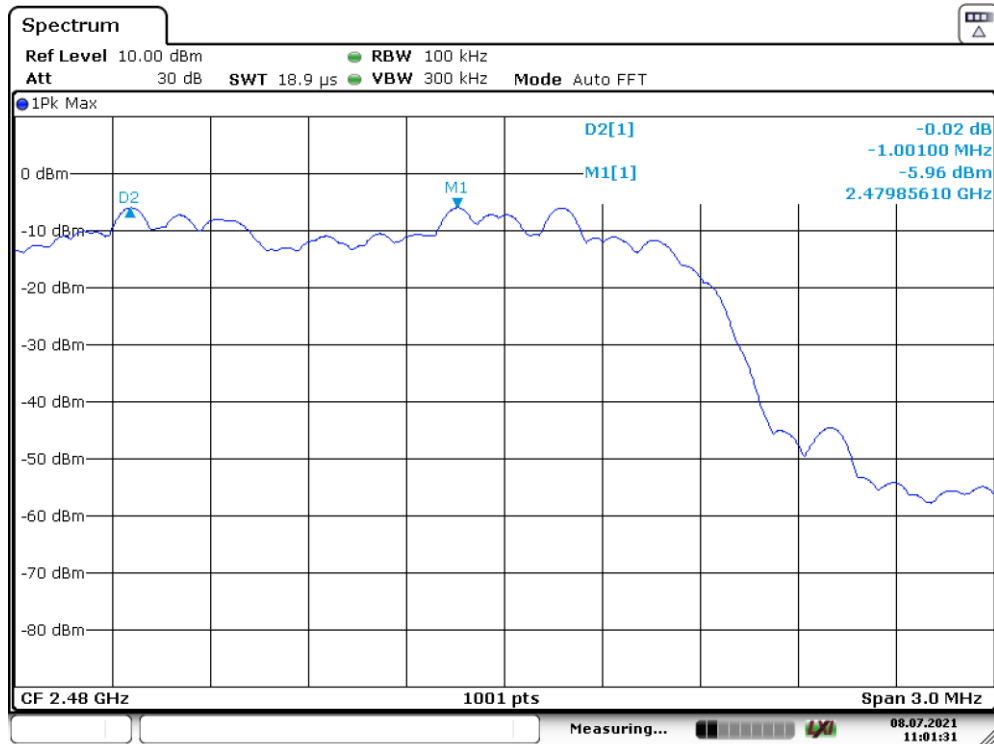

Date: 8.JUL.2021 11:01:31

## 9. 20dB Bandwidth test

### 9.1 Measurement Procedure

The EUT was operating in hopping mode or could be controlled its channel. Printed out the test result from the spectrum by hard copy function.

### 9.2 Test SET-UP (Block Diagram of Configuration)

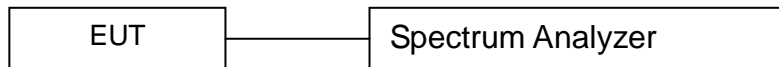

### 9.3 Measurement Equipment Used:

EQUIPMENT TYPE	MFR	MODEL NUMBER	SERIAL NUMBER	CALIBRATED UNTIL
Spectrum Analyzer	Rohde & Schwarz	FSV40	US40240623	2021-11-19
Coaxial Cable	Gigalink Microwave	ZT40	19022092	2021-11-19
Antenna Connector	ARTHUR-YANG	2244-N1TG1	N/A	2021-11-19

Remark: The temporary antenna connector is soldered on the PCB board in order to perform conducted tests and this temporary antenna connector is listed in the equipment list.

### 9.4 Measurement Results:

Refer to attached data chart.

Spectrum Detector:	PK	Test Date :	July 09, 2021
Test By:	Best	Temperature :	24°C
Test Result:	PASS	Humidity :	53 %
Modulation:	GFSK		

Channel number	Channel frequency (MHz)	20dB Down BW(kHz)
1	2402	942
40	2441	946
79	2480	945

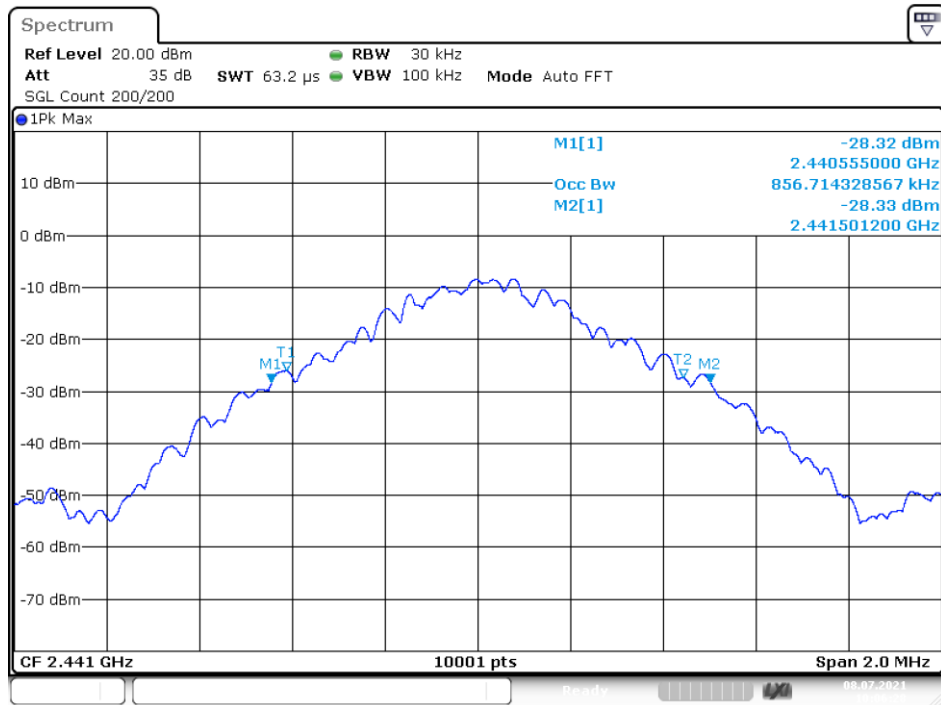
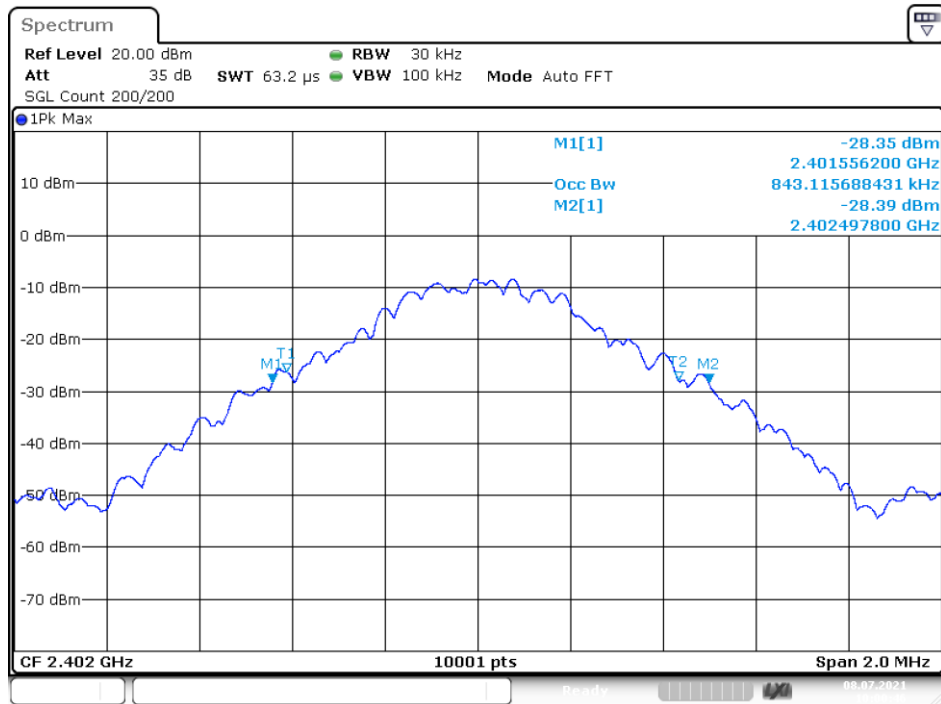





Report No.: EA21070082F01001

42 of 78

Spectrum Detector:	PK	Test Date :	July 09, 2021
Test By:	Best	Temperature :	24°C
Test Result:	PASS	Humidity :	53 %
Modulation:	Π/4-DQPSK		

Channel number	Channel frequency (MHz)	20dB Down BW(kHz)
1	2402	1311
40	2441	1314
79	2480	1313

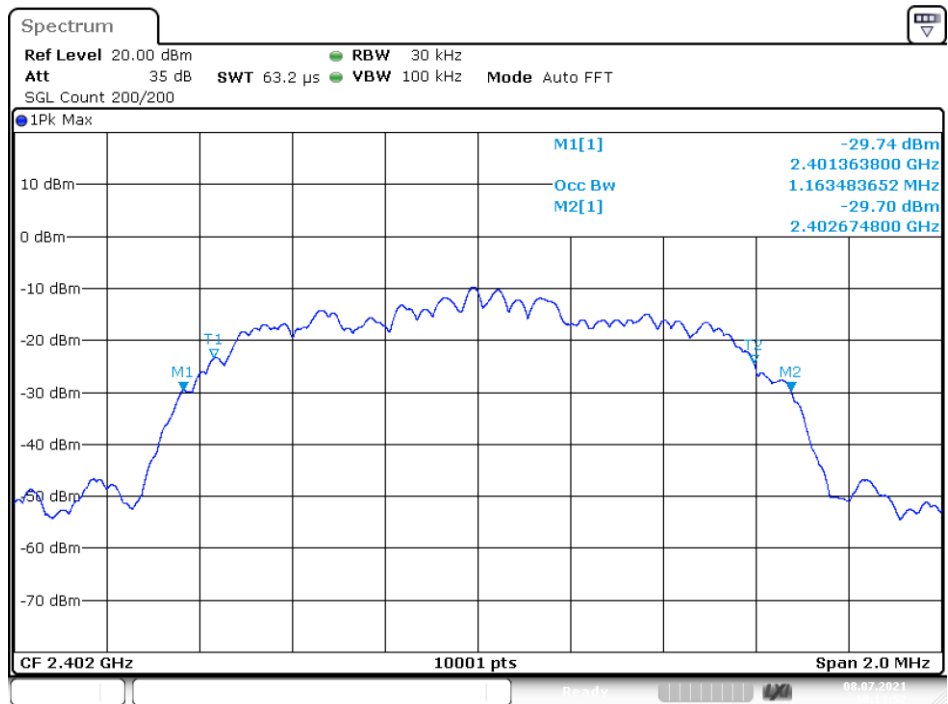

Date: 8.JUL.2021 10:13:52

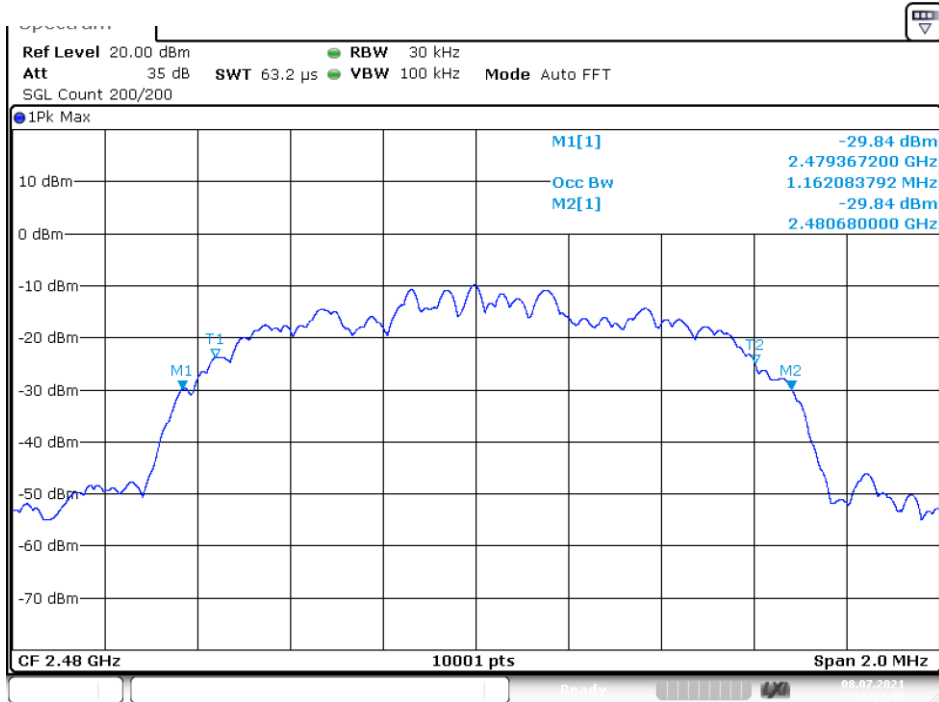
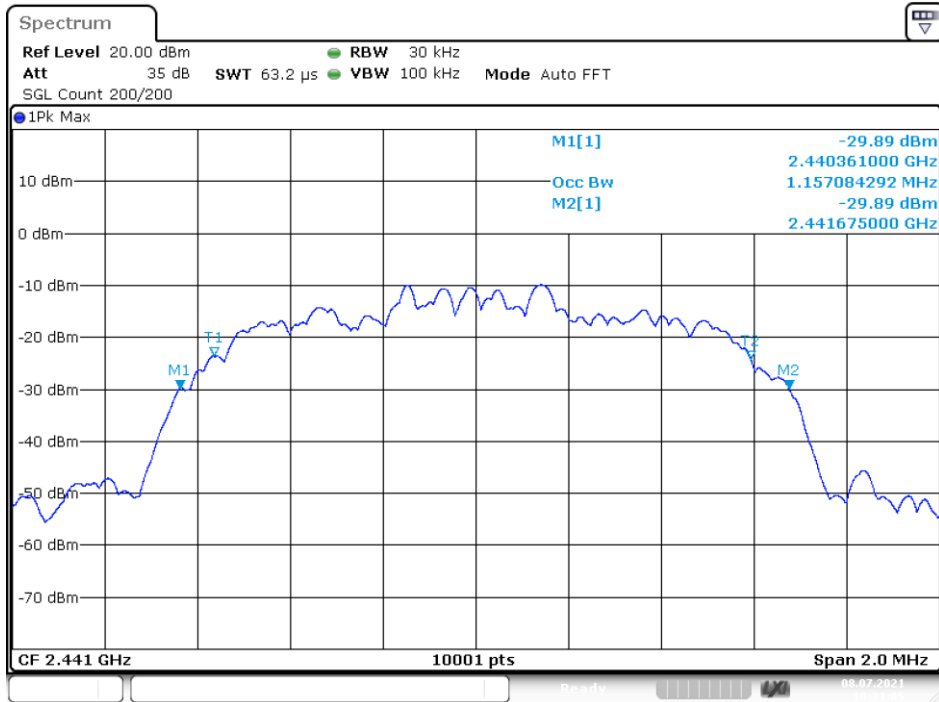



Report No.: EA21070082F01001

44 of 78

Spectrum Detector: PK  
Test By: Best  
Test Result: PASS  
Modulation: 8DPSK

Test Date : July 09, 2021  
Temperature : 24°C  
Humidity : 53 %

Channel number	Channel frequency (MHz)	20dB Down BW(kHz)
1	2402	1294
40	2441	1279
79	2480	1304

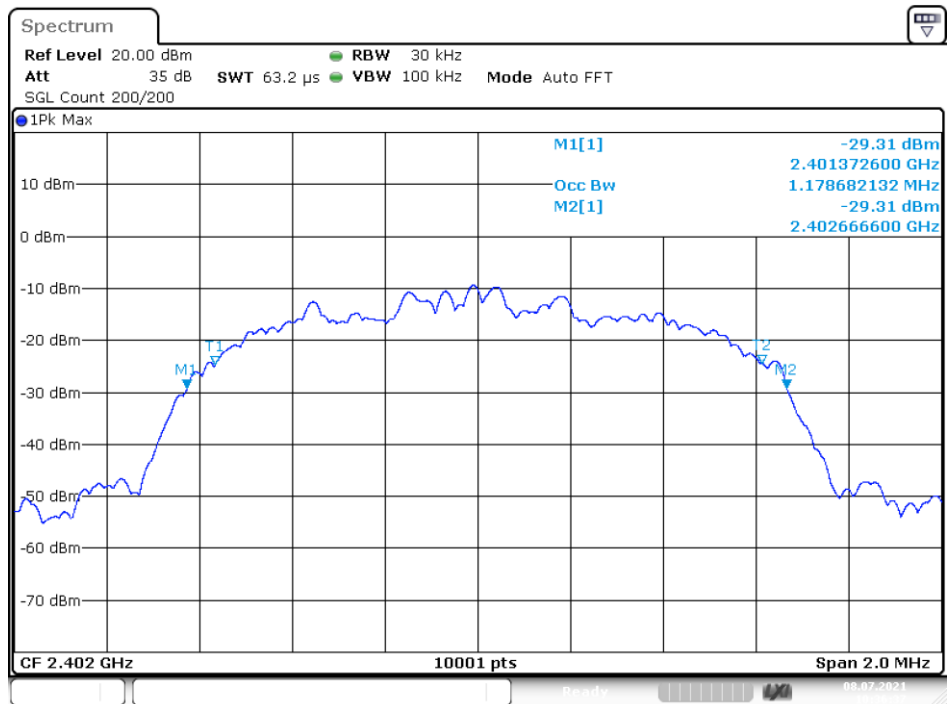

Date: 8.JUL.2021 10:36:36

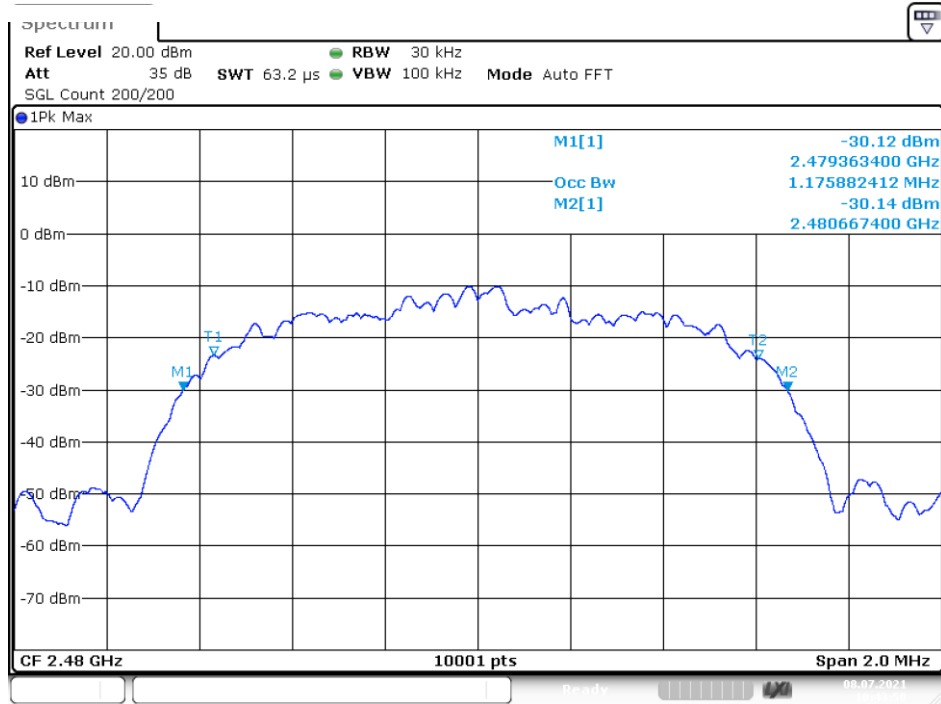
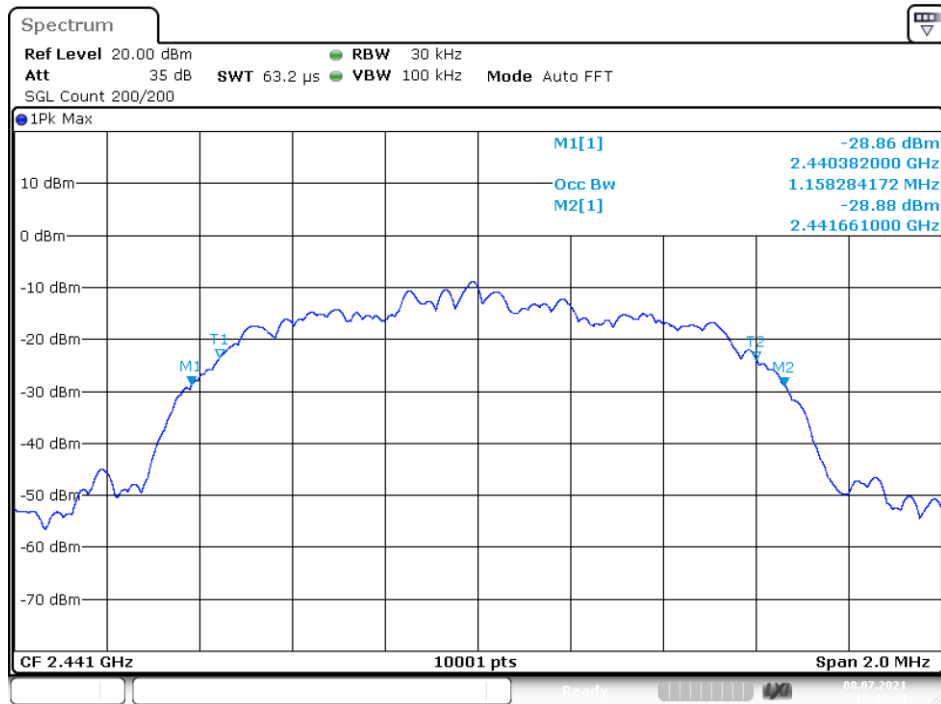

## 10. Quantity of Hopping Channel Test

### 10.1 Measurement Procedure

The EUT was operating in hopping mode or could be controlled its channel. Printed out the test result from the spectrum by hard copy function.

### 10.2 Test SET-UP (Block Diagram of Configuration)

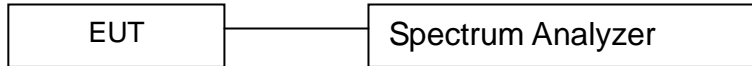

### 10.3 Measurement Equipment Used:

EQUIPMENT TYPE	MFR	MODEL NUMBER	SERIAL NUMBER	CALIBRATED UNTIL
Spectrum Analyzer	Rohde & Schwarz	FSV40	US40240623	2021-11-19
Coaxial Cable	Gigalink Microwave	ZT40	19022092	2021-11-19
Antenna Connector	ARTHUR-YANG	2244-N1TG1	N/A	2021-11-19

Remark: The temporary antenna connector is soldered on the PCB board in order to perform conducted tests and this temporary antenna connector is listed in the equipment list.

### 10.4 Measurement Results:

Refer to attached data chart.

Worst Test Mode	GFSK	Test Date :	July 09, 2021
Test By:	Best	Temperature :	24 °C
Test Result:	PASS	Humidity :	53 %

Hopping Channel Frequency Range	Quantity of Hopping Channel	Quantity of Hopping Channel
2402-2480	79	> 15

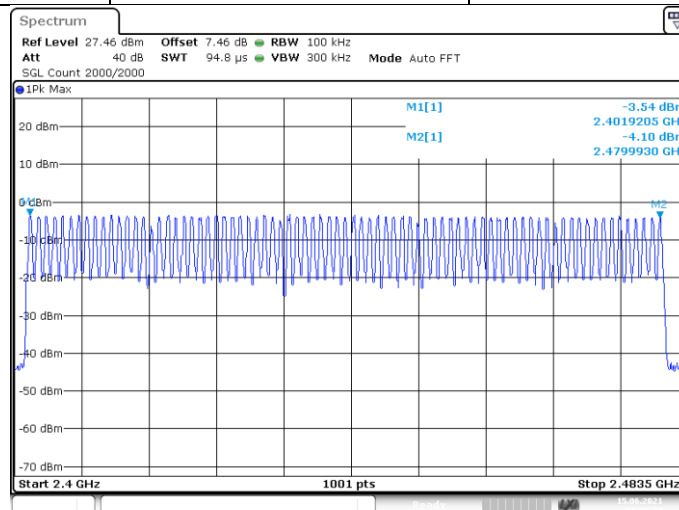

## 11. Time of Occupancy (Dwell Time) test

### 11.1 Test Description

The Equipment Under Test (EUT) was set up to perform the dwell time measurements. The EUT was connected to the spectrum analyzer via a short coax cable. The dwell time is calculated by:

$$\text{Dwell time} = \text{time slot length} * \text{hop rate} / \text{number of hopping channels} * 31.6\text{s}$$

with:

- hop rate =  $1600 * 1/\text{s}$  for DH1 packets =  $1600 \text{ s}^{-1}$
- hop rate =  $1600/3 * 1/\text{s}$  for DH3 packets =  $533.33 \text{ s}^{-1}$
- number of hopping channels = 79
- $31.6 \text{ s} = 0.4 \text{ seconds multiplied by the number of hopping channels} = 0.4 \text{ s} * 79$

The highest value of the dwell time is reported.

### 11.2 Test SET-UP (Block Diagram of Configuration)

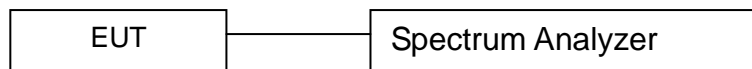

### 11.3 Measurement Equipment Used:

EQUIPMENT TYPE	MFR	MODEL NUMBER	SERIAL NUMBER	CALIBRATED UNTIL
Spectrum Analyzer	Rohde & Schwarz	FSV40	US40240623	2021-11-19
Coaxial Cable	Gigalink Microwave	ZT40	19022092	2021-11-19
Antenna Connector	ARTHUR-YANG	2244-N1TG1	N/A	2021-11-19

Remark: The temporary antenna connector is soldered on the PCB board in order to perform conducted tests and this temporary antenna connector is listed in the equipment list.

### 11.4 Test Requirements / Limits

FCC Part 15, Subpart C, §15.247 (a) (1) (iii)

Frequency hopping systems in the 2400-2483.5 MHz band shall use at least 15 channels. The average time of occupancy on any channel shall not be greater than 0.4 seconds within a period of 0.4 seconds multiplied by the number of hopping channels employed. Since the Bluetooth technology uses 79 channels this period is calculated to be 31.6seconds. Refer to attached data chart.

Modulation:	GFSK	Test Date :	July 09, 2021
Test By:	Best	Temperature :	24 °C
Test Result:	PASS	Humidity :	53 %

### 11.5 Test result

Mode	Number of transmission in a 31.6( 79 Hopping*0.4)	Length of transmissions time(msec)	Result (msec)	Limit (msec)
DH1	$1600/(2*79) \times 31.6 = 320$	0.382	122.24	400
DH3	$1600/(4*79) \times 31.6 = 160$	1.641	262.56	400
DH5	$1600/(6*79) \times 31.6 = 106.67$	2.869	306.04	400

Remark: The results of worst cased was recorded.

DH1:

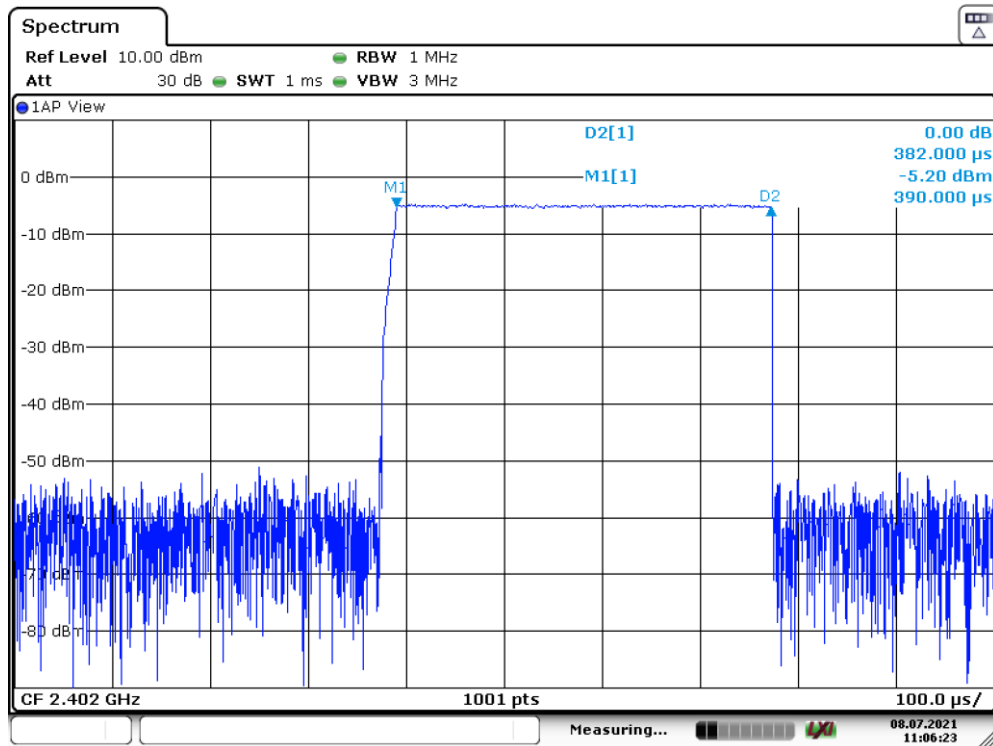

Date: 8.JUL.2021 11:06:23



DH3:

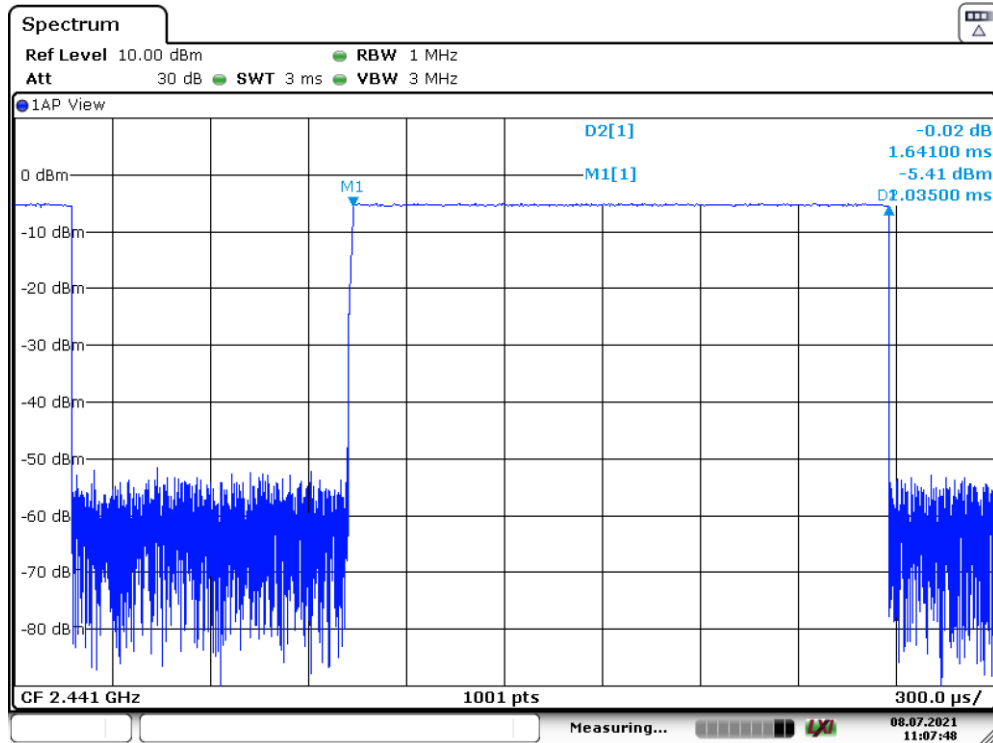

Date: 8.JUL.2021 11:07:47

DH5:

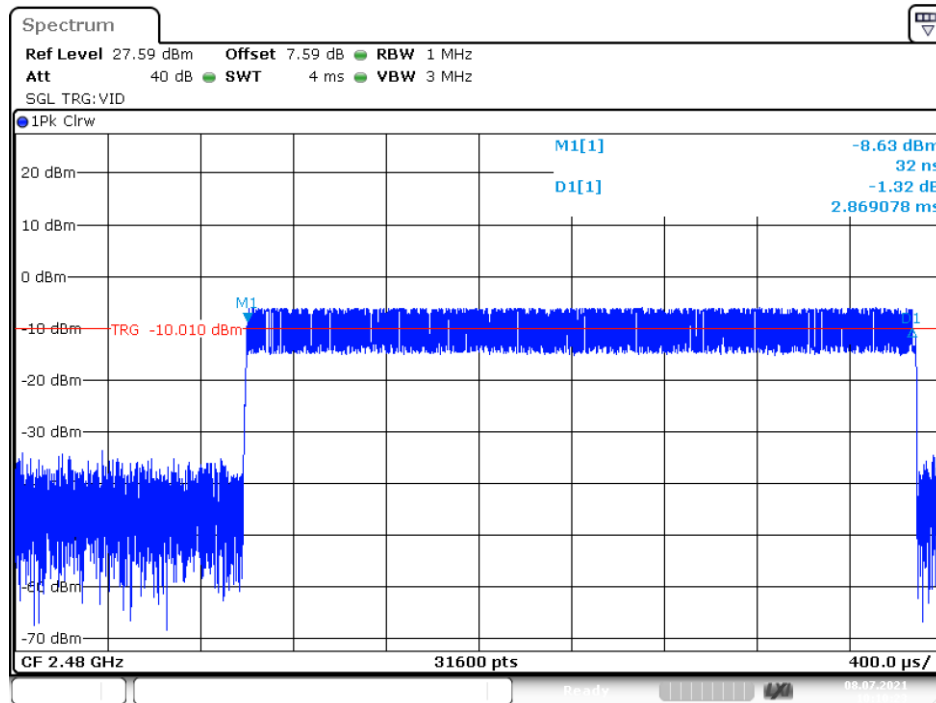

Date: 8.JUL.2021 10:10:24

## 12. MAXIMUM PEAK OUTPUT POWER TEST

### 12.1 Measurement Procedure

- a. Check the calibration of the measuring instrument(SA) using either an internal calibrator or a known signal from an external generator.
- b. Turn on the EUT and connect it to measurement instrument. Then set it to any one convenient frequency within its operating range. Set a reference level on the measuring instrument equal to the highest peak value.
- c. The center frequency of the spectrum analyzer is set to the fundamental frequency and using proper RBW and VBW setting.
- d. Measure the captured power within the band and recording the plot.
- e. Repeat above procedures until all frequencies required were complete.

### 12.2 Test SET-UP (Block Diagram of Configuration)

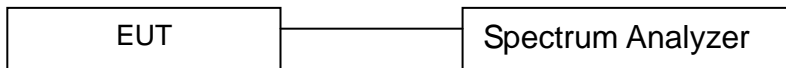

### 12.3 Measurement Equipment Used:

EQUIPMENT TYPE	MFR	MODEL NUMBER	SERIAL NUMBER	CALIBRATED UNTIL
Spectrum Analyzer	Rohde & Schwarz	FSV40	US40240623	2021-11-19
Coaxial Cable	Gigalink Microwave	ZT40	19022092	2021-11-19
Antenna Connector	ARTHUR-YANG	2244-N1TG1	N/A	2021-11-19

Remark: The temporary antenna connector is soldered on the PCB board in order to perform conducted tests and this temporary antenna connector is listed in the equipment list.

### 12.4 Measurement Results:

Refer to attached data chart.

Spectrum Detector:	PK	Test Date :	July 09, 2021
Test By:	Best	Temperature :	24 °C
Test Result:	PASS	Humidity :	53 %
Modulation:	GFSK		

Channel number	Channel Frequency (MHz)	Peak Power output(dBm)	Peak Power output(mW)	Peak Power Limit(mW)	Pass/Fail
01	2402	2.25	1.679	1000	PASS
40	2441	2.45	1.758	1000	PASS
79	2480	2.00	1.585	1000	PASS

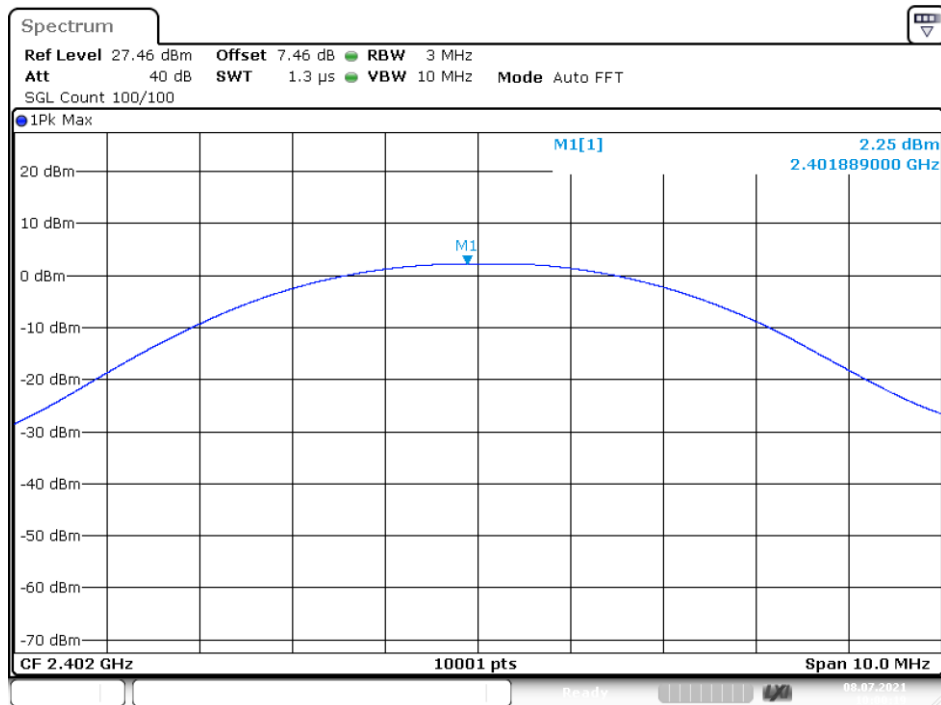

Date: 8.JUL.2021 10:00:19

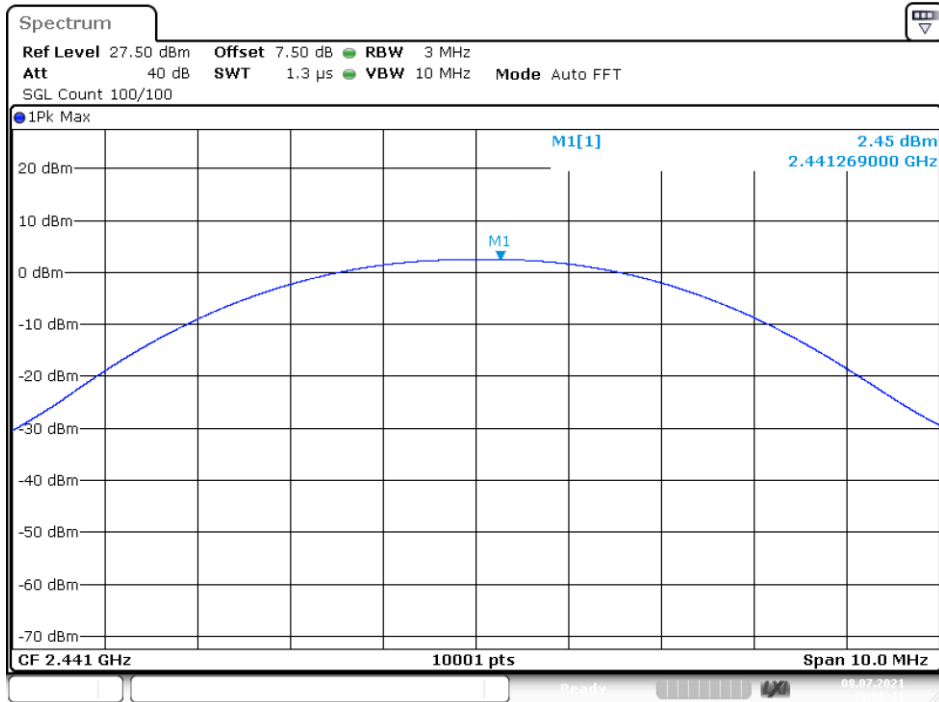

Date: 8.JUL.2021 10:06:12

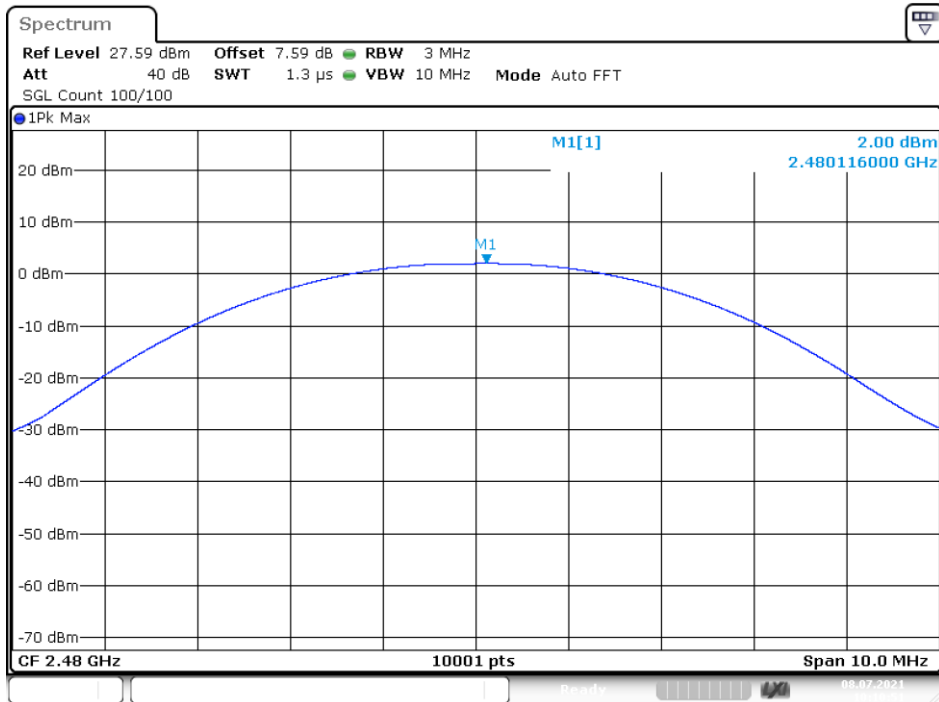

Date: 8.JUL.2021 10:10:52

Report No.: EA21070082F01001  
 Spectrum Detector: PK  
 Test By: Best  
 Test Result: PASS  
 Modulation: Π/4-DQPSK

53 of 78  
 Test Date : July 09, 2021  
 Temperature : 24 °C  
 Humidity : 53 %

Channel number	Channel Frequency (MHz)	Peak Power output(dBm)	Peak Power output(mW)	Peak Power Limit(mW)	Pass/Fail
01	2402	2.76	1.888	125	PASS
40	2441	2.9	1.950	125	PASS
79	2480	1.9	1.549	125	PASS

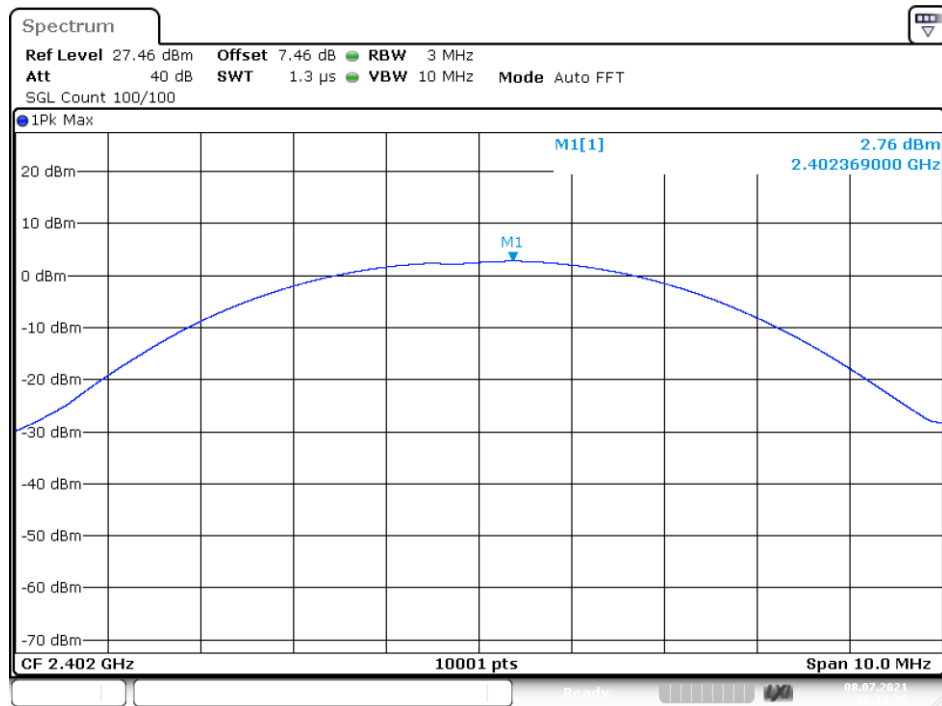

Date: 8.JUL.2021 10:13:35

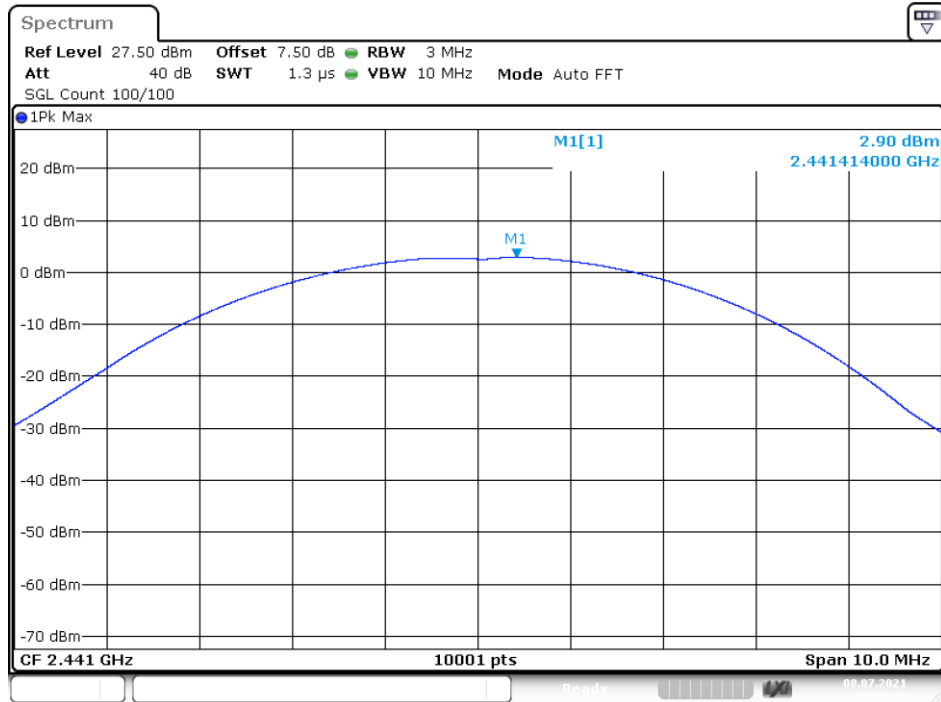

Date: 8.JUL.2021 10:20:26

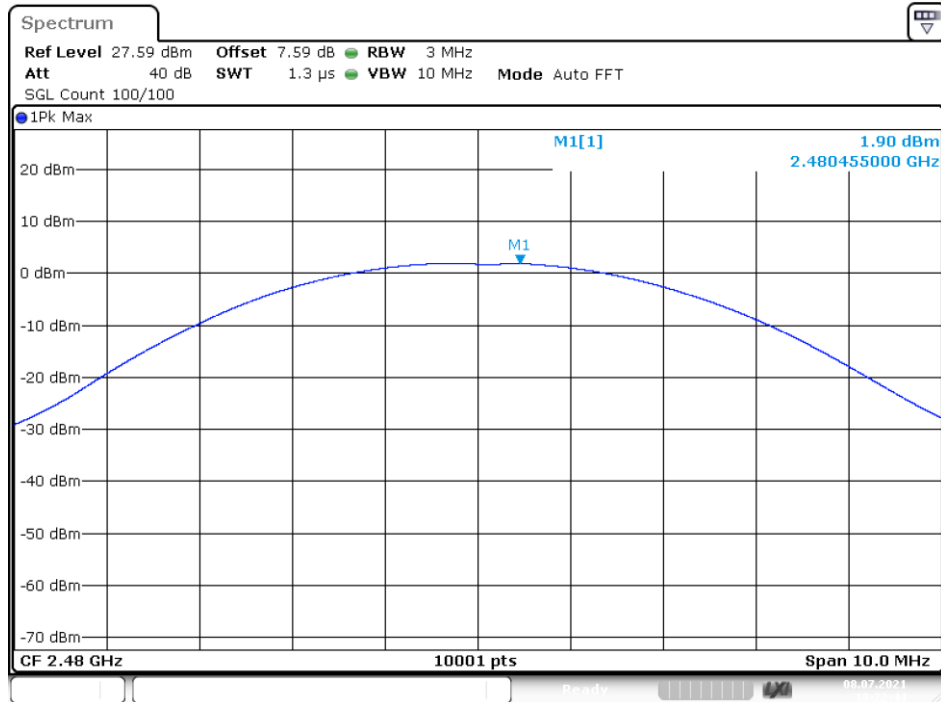

Date: 8.JUL.2021 10:22:44



Report No.: EA21070082F01001

55 of 78

Spectrum Detector: PK  
Test By: Best  
Test Result: PASS  
Modulation: 8DPSK

Test Date : 2021-07-07  
Temperature : 24 °C  
Humidity : 53 %

Channel number	Channel Frequency (MHz)	Peak Power output(dBm)	Peak Power output(mW)	Peak Power Limit(mW)	Pass/Fail
01	2402	3.21	2.094	125	PASS
40	2441	3.1	2.042	125	PASS
79	2480	2.55	1.799	125	PASS

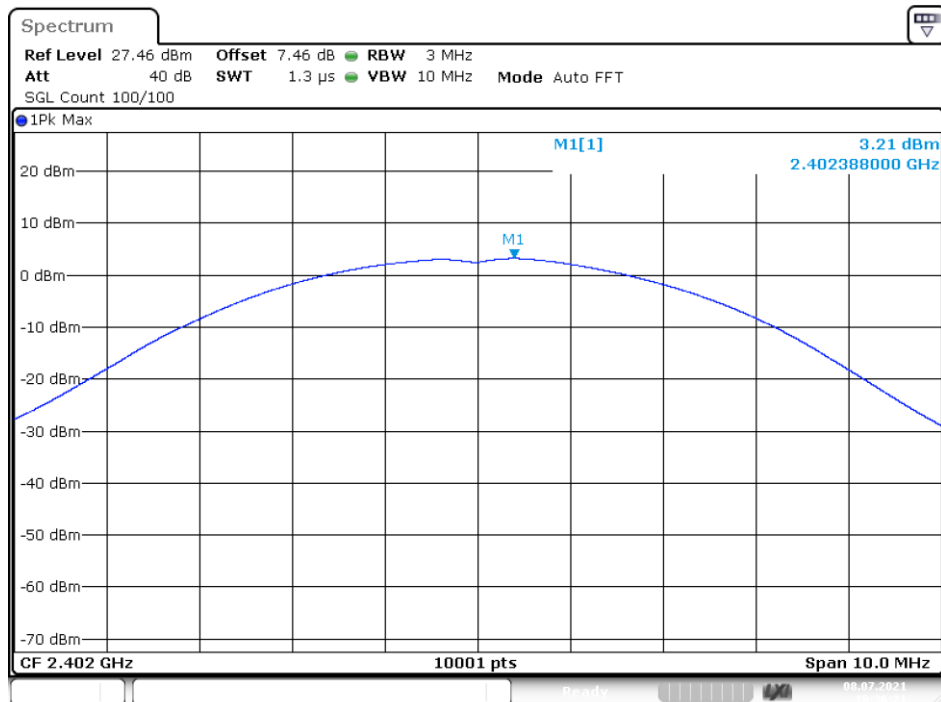

Date: 8.JUL.2021 10:36:20

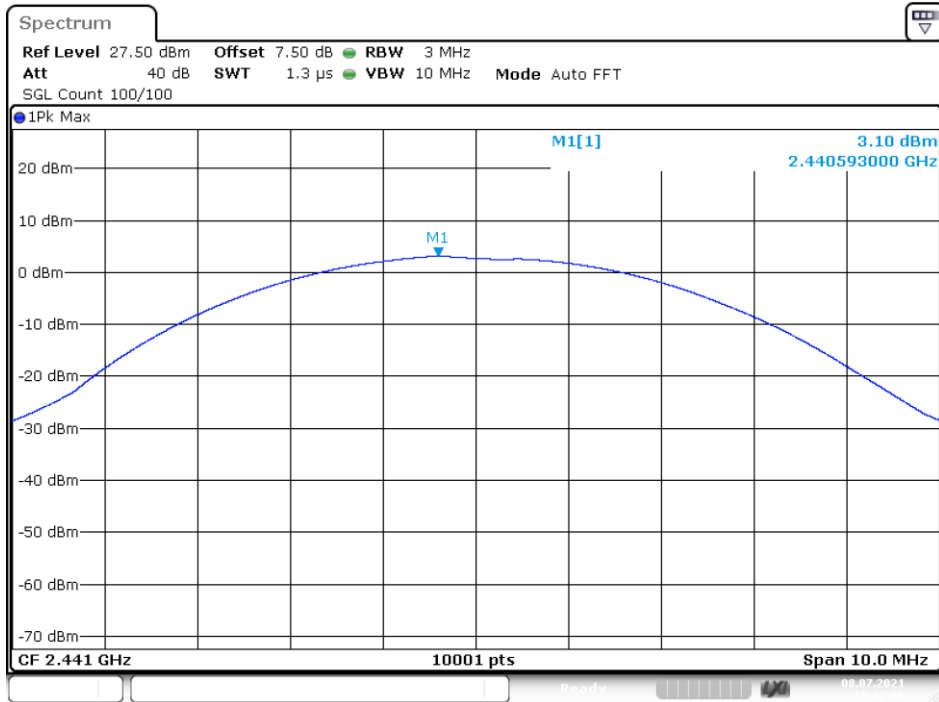

Date: 8.JUL.2021 10:42:06

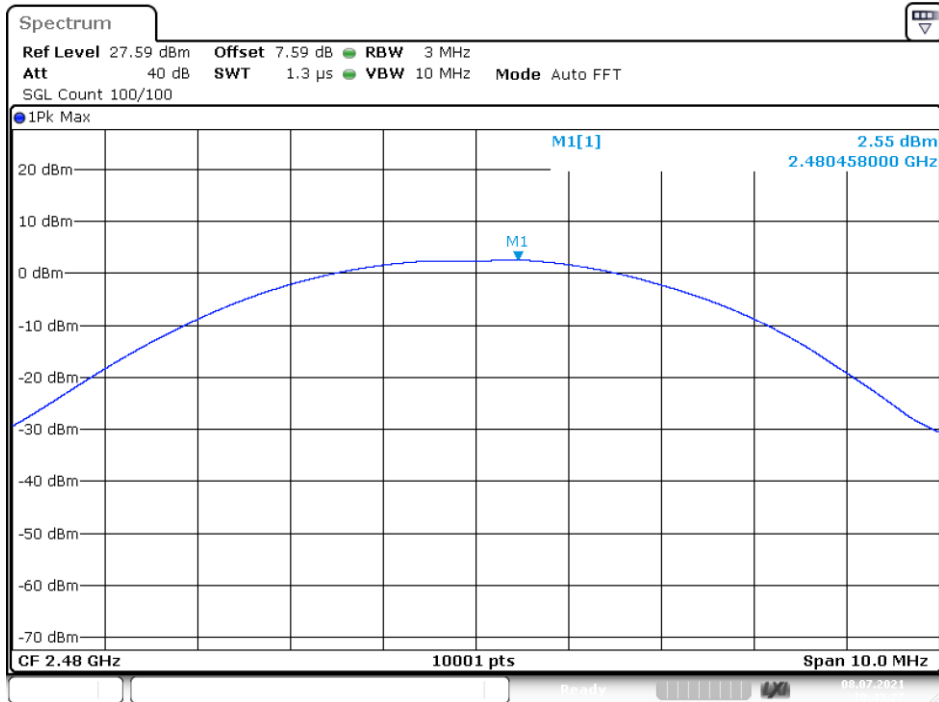

Date: 8.JUL.2021 10:43:28



### 13. Band EDGE test

#### 13.1 Measurement Procedure

##### For Conducted Test

1. The transmitter output is connected to a spectrum analyzer. The resolution bandwidth is set to 100KHz. The video bandwidth is set to 300KHz.
2. The spectrum from 30MHz to 26 GHz is investigated with the transmitter set to the lowest, middle, and highest channels.

EMI Test Receiver	Setting
Attenuation	Auto
RBW	100KHz
VBW	300KHz
Detector	Peak
Trace	Max hold

##### For Radiated emission Test

The EUT was placed on a styrofoam table which is 1.5m above ground plane.

The measurement procedure at the band edges was simplified by performing the measurement in just one plot. Both, the in-band-emission and the unwanted emission were encompassed by the span. After trace stabilization, the maximum peak was determined by a peak detector and the value was marked by an appropriate limit line. The second limit line, which is 20dB below the first, marks the limit for the emissions in the unrestricted band. A maximum-peak-detector marks the highest emission in the unrestricted band next to the band edge.

The measurements were performed at the lower end of the 2.4GHz band.

Use the following spectrum analyzer settings:

For Restricted Band, When spectrum scanned above 1GHz setting resolution bandwidth 1MHz, video bandwidth 3MHz:

EMI Test Receiver	Setting
Attenuation	Auto
RBW	1MHz
VBW	3MHz
Detector	Peak
Trace	Max hold

For Non-Restricted Band, When spectrum scanned above 1GHz setting resolution bandwidth 100KHz, video bandwidth 300KHz:

EMI Test Receiver	Setting
Attenuation	Auto
RBW	100KHz
VBW	300KHz
Detector	Peak
Trace	Max hold

### 13.2 Test SET-UP (Block Diagram of Configuration)

For Conducted Test

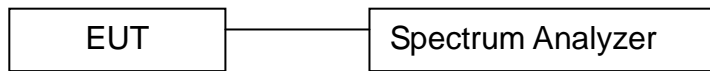

For Radiated emission Test

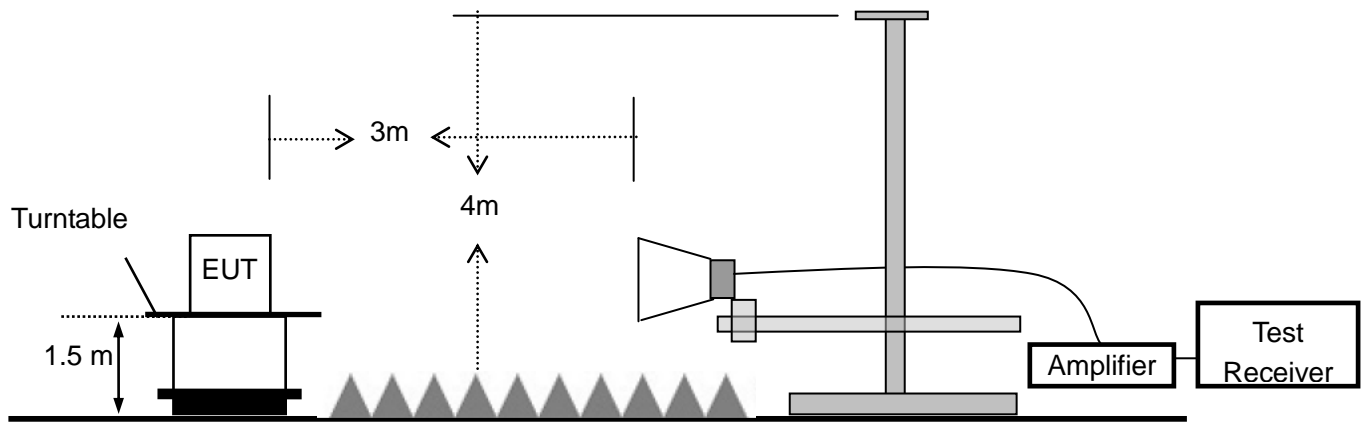

### 13.3 Measurement Equipment Used:

For Conducted Test

EQUIPMENT TYPE	MFR	MODEL NUMBER	SERIAL NUMBER	CALIBRATED UNTIL
Spectrum Analyzer	Rohde & Schwarz	FSV40	US40240623	2021-11-19
Coaxial Cable	Gigalink Microwave	ZT40	19022092	2021-11-19
Antenna Connector	ARTHUR-YANG	2244-N1TG1	N/A	2021-11-19

Remark: The temporary antenna connector is soldered on the PCB board in order to perform conducted tests and this temporary antenna connector is listed in the equipment list.

For Radiated emission Test

Item	Equipment	Manufacturer	Model No.	Serial No.	Calibrated Until
1	Signal Analyzer	Rohde & Schwarz	FSV40	US40240623	2022-05-23
2	Broadband RF Power Amplifier	AEROFLEX	AEROFLEX100KHz-40G Hz	J1013130524 001	2022-05-23
3	DRG Horn Antenna	A.H.SYSTEMS	SAS-574	J2031090612 123	2022-05-23
4	RF Cable	Gigalink Microwave	ZT40-2.92J-2.92J-2m	N/A	2022-05-23
5	RF Cable	Gigalink Microwave	ZT40-2.92J-2.92J-0.3m	N/A	2022-05-23

### 13.4 Measurement Results:

Refer to attached data chart.

Spectrum Detector:	PK	Test Date :	July 09, 2021
Test By:	Best	Temperature :	24 °C
Test Result:	PASS	Humidity :	53 %

#### 1. Conducted Test

For Non-Hopping Mode:

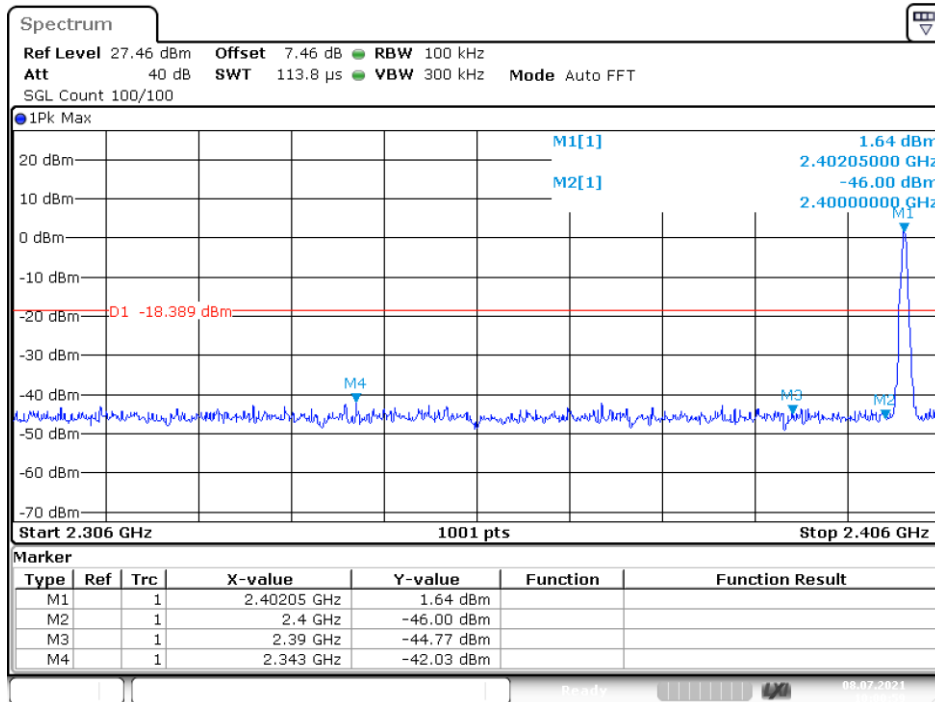

#### Test plots of GFSK

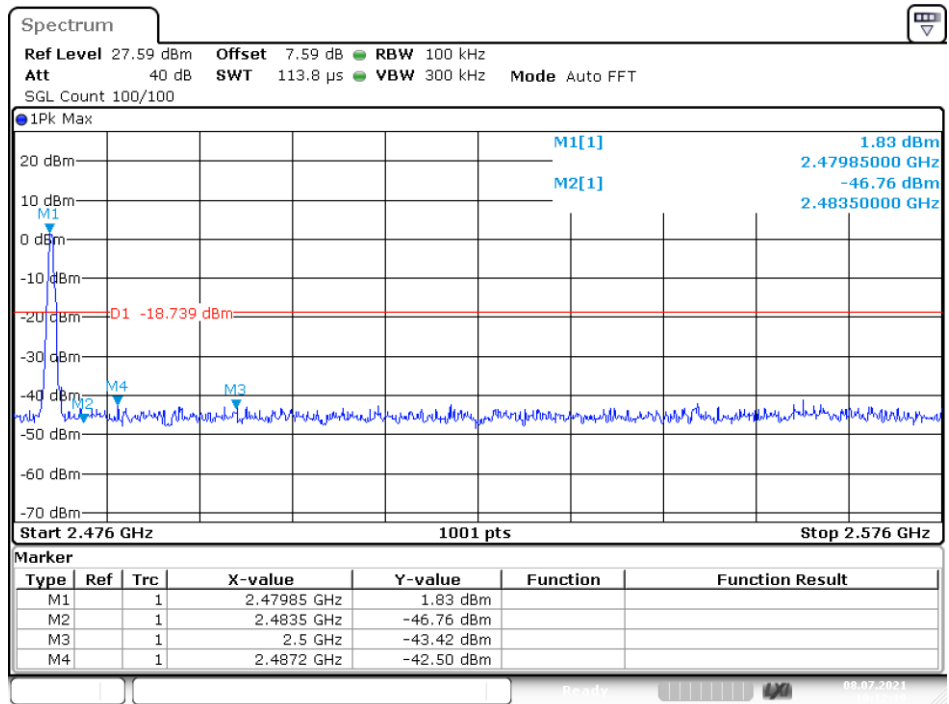

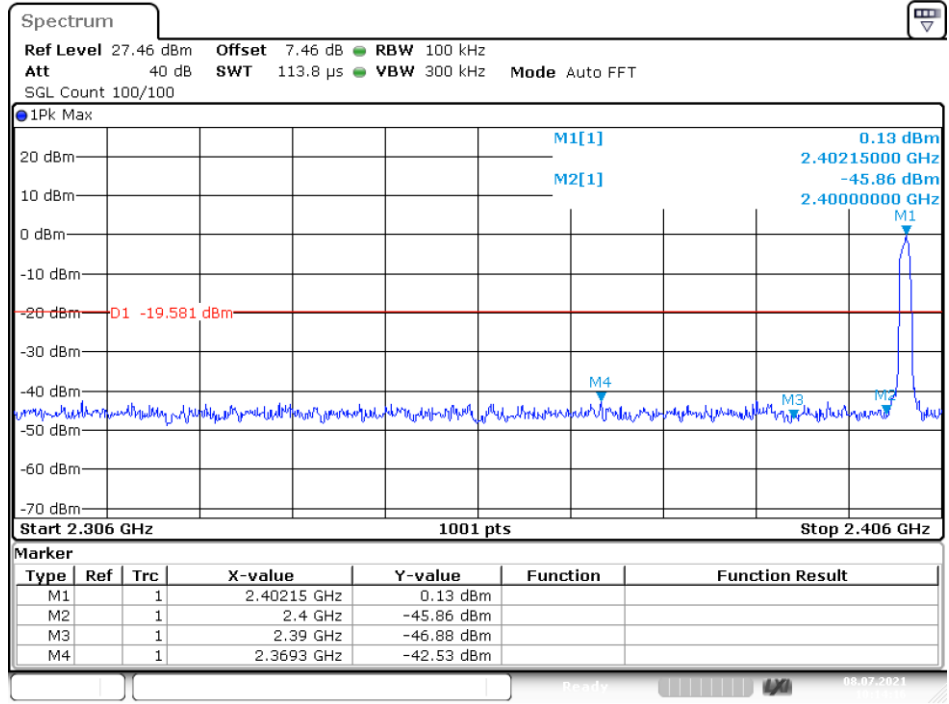

### Test plots of pi/4-DQPSK

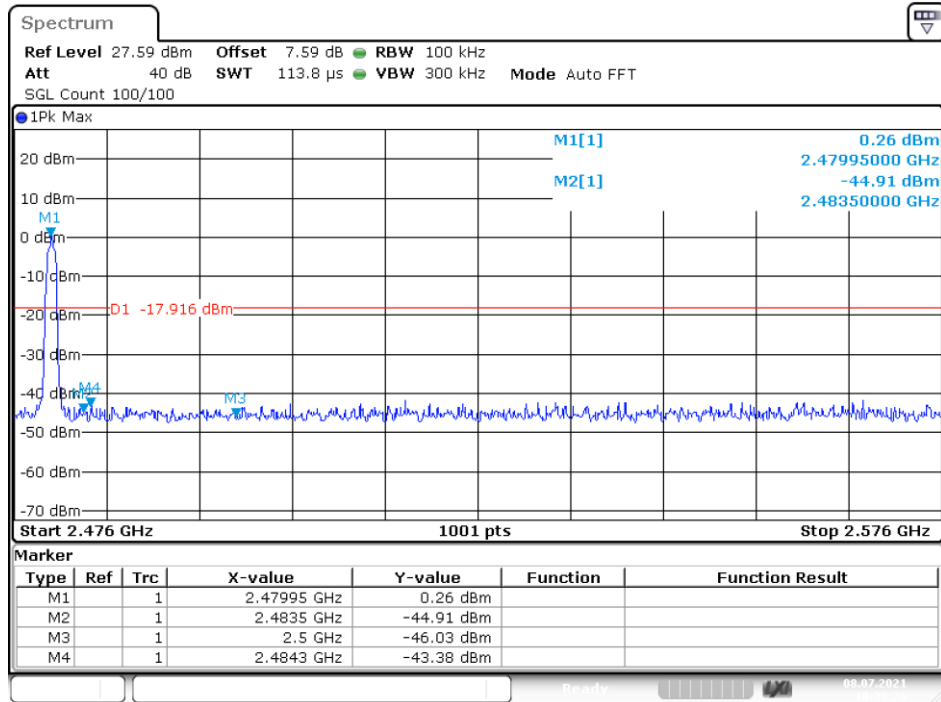



### Test plots of 8DPSK

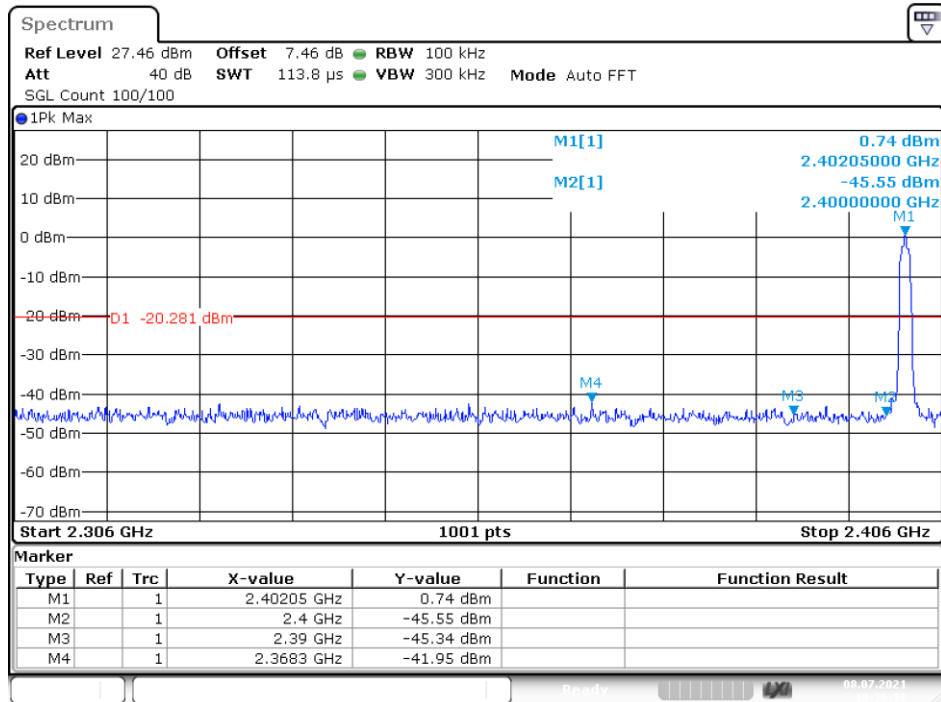

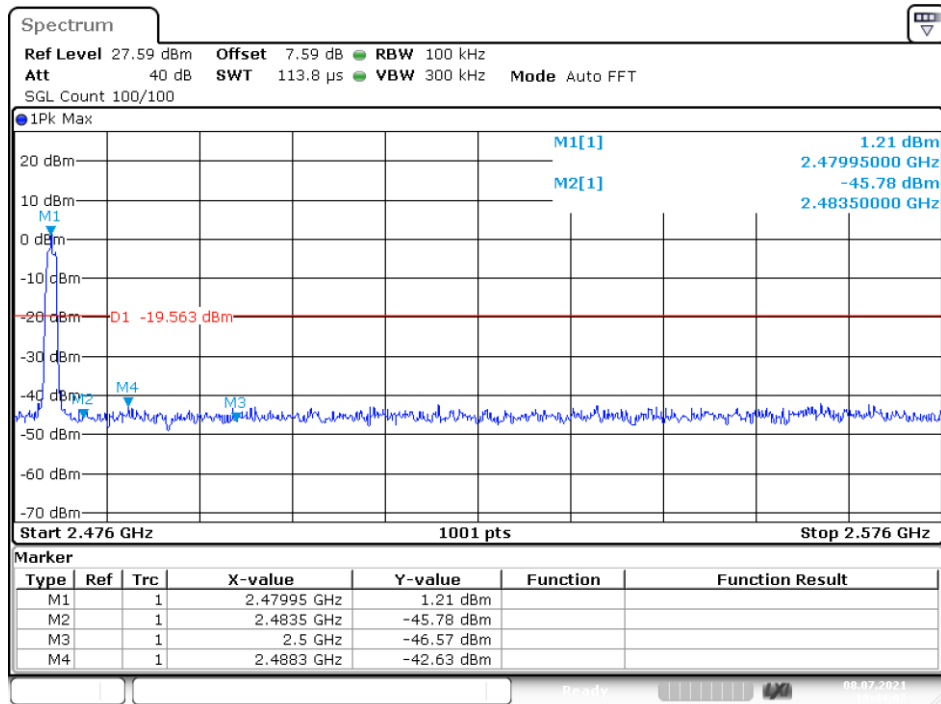

For Hopping Mode:

Frequency (MHz)	Modulation	Peak Power Output(dBm)	Emission(dBm)	Result of Band edge(dBc)	Band edge Limit(dBc)
2327.7	GFSK	0.24	-42.22	42.46	>20dBc
2388.2	pi/4-DQPSK	-3.57	-41.51	37.94	>20dBc
2405.85	8DPSK	-1.29	-42.73	41.44	>20dBc
2490.9	GFSK	-1.77	-42.18	40.41	>20dBc
2485	pi/4-DQPSK	-3.64	-42.58	38.94	>20dBc
2486.5	8DPSK	-4.83	-42.65	37.82	>20dBc

### Test plots of GFSK

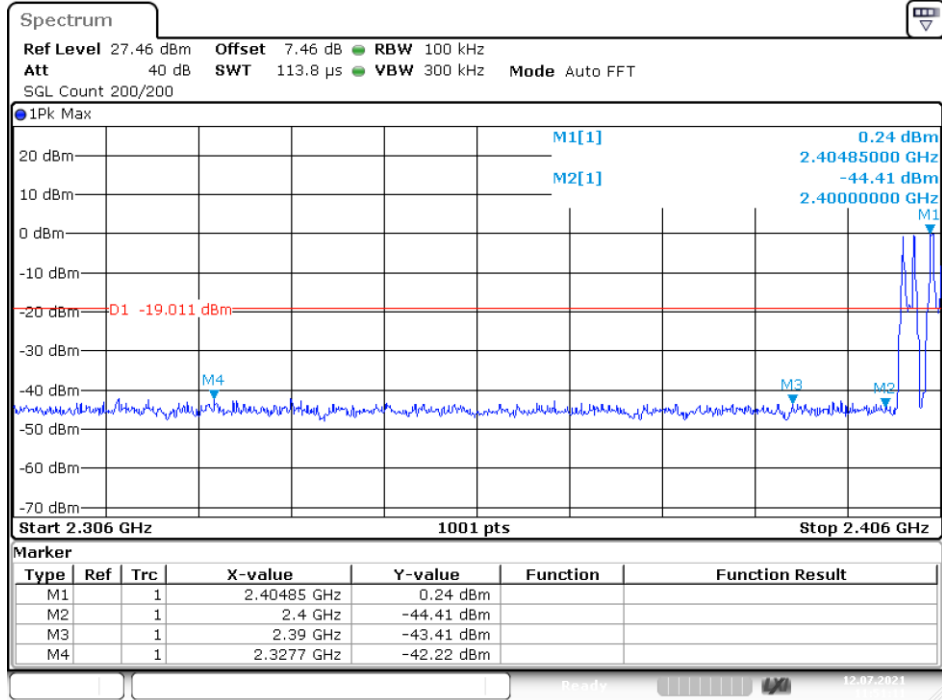

Date: 12.JUL.2021 11:51:11

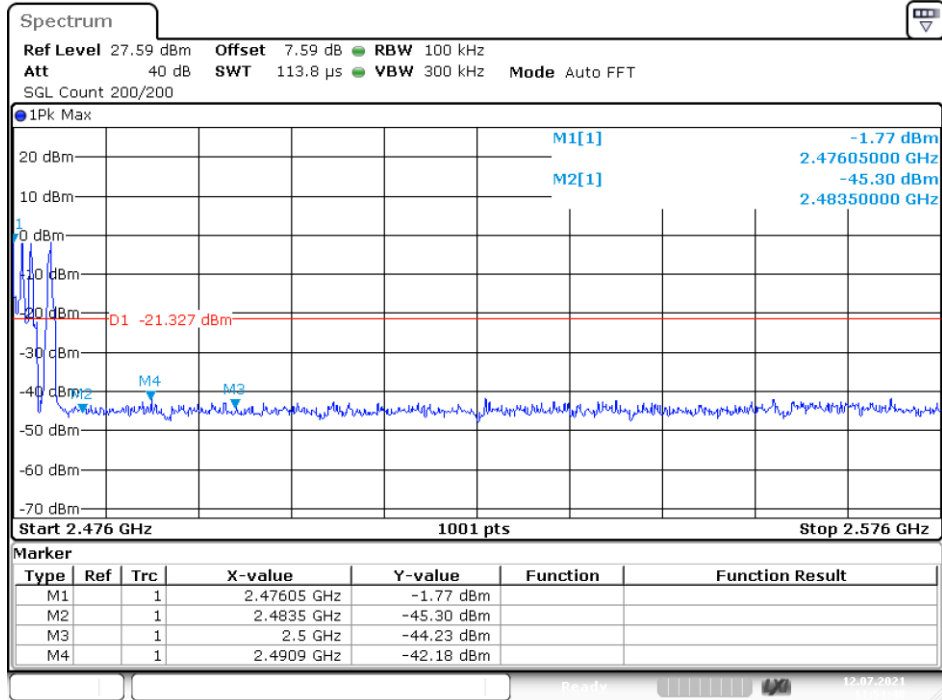

Date: 12.JUL.2021 11:51:48

### Test plots of pi/4-DQPSK

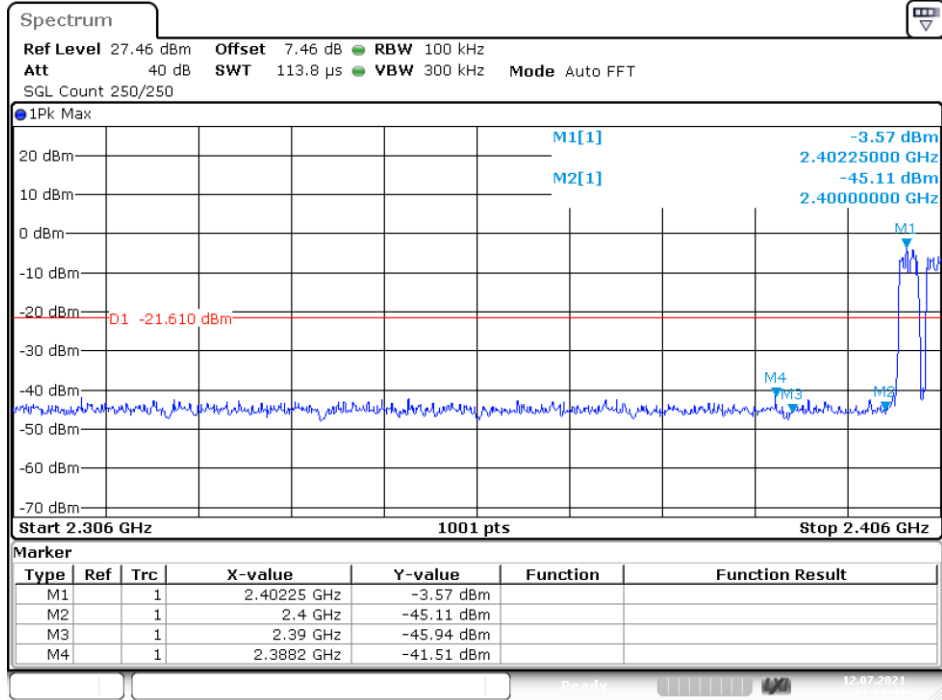

Date: 12.JUL.2021 11:53:48

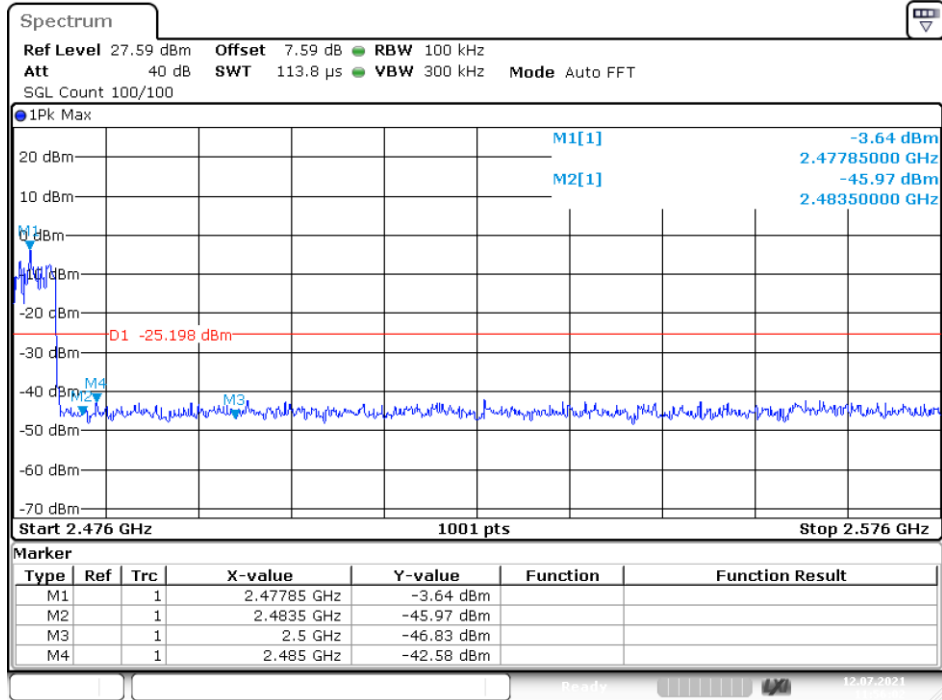

Date: 12.JUL.2021 11:56:01



### Test plots of 8DPSK

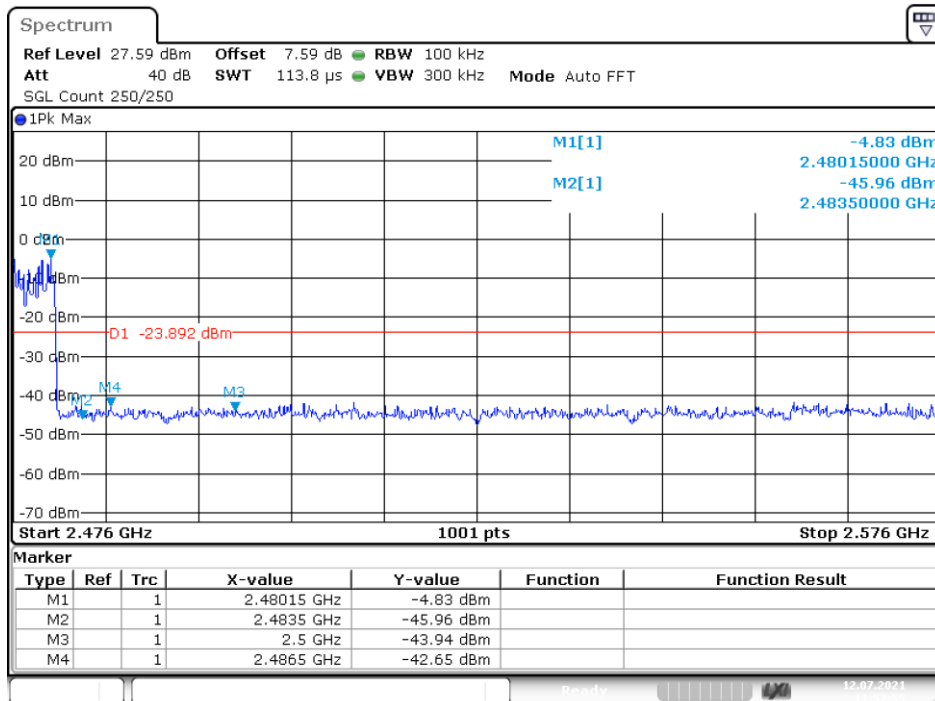
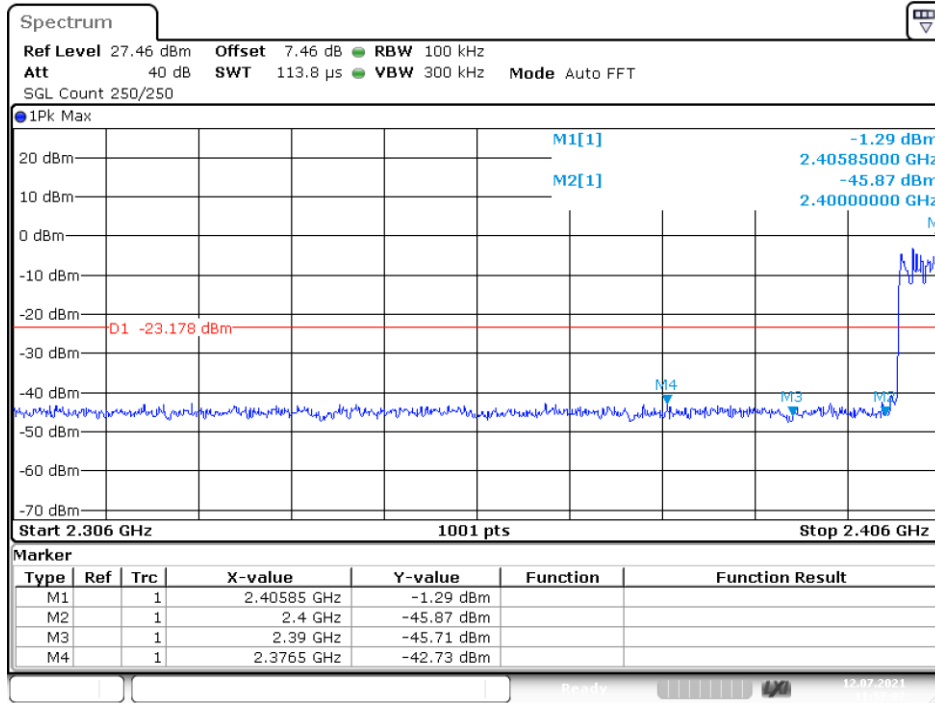



2. Radiated emission Test  
**Worst test modulation GFSK**  
 For Non-Hopping Mode:

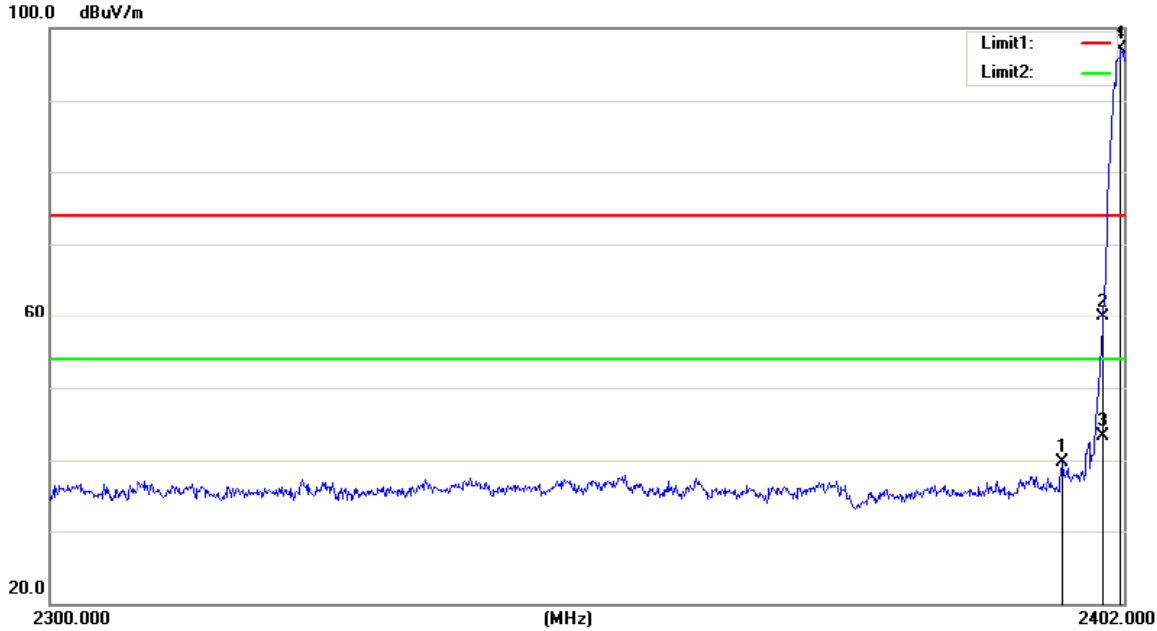

Site site #1 Polarization: **Horizontal** Temperature: 26  
 Limit: (RE)FCC PART 15 C 3m\_PEAK Power: Battery 3.7V Humidity: 55 %  
 Mode:DSS (TX2402)

Note:

No.	Mk.	Freq.	Reading Level	Correct Factor	Measurement	Limit	Over	Antenna Height	Table Degree	Comment
		MHz	dBuV	dB	dBuV/m	dBuV/m	dB	cm	degree	
1		2396.084	60.65	-20.95	39.70	74.00	-34.30	peak	0	
2		2400.000	80.87	-20.93	59.94	74.00	-14.06	peak	0	
3		2400.000	64.20	-20.93	43.27	54.00	-10.73	AVG	0	
4	*	2401.694	118.02	-20.93	97.09	74.00	23.09	peak	0	









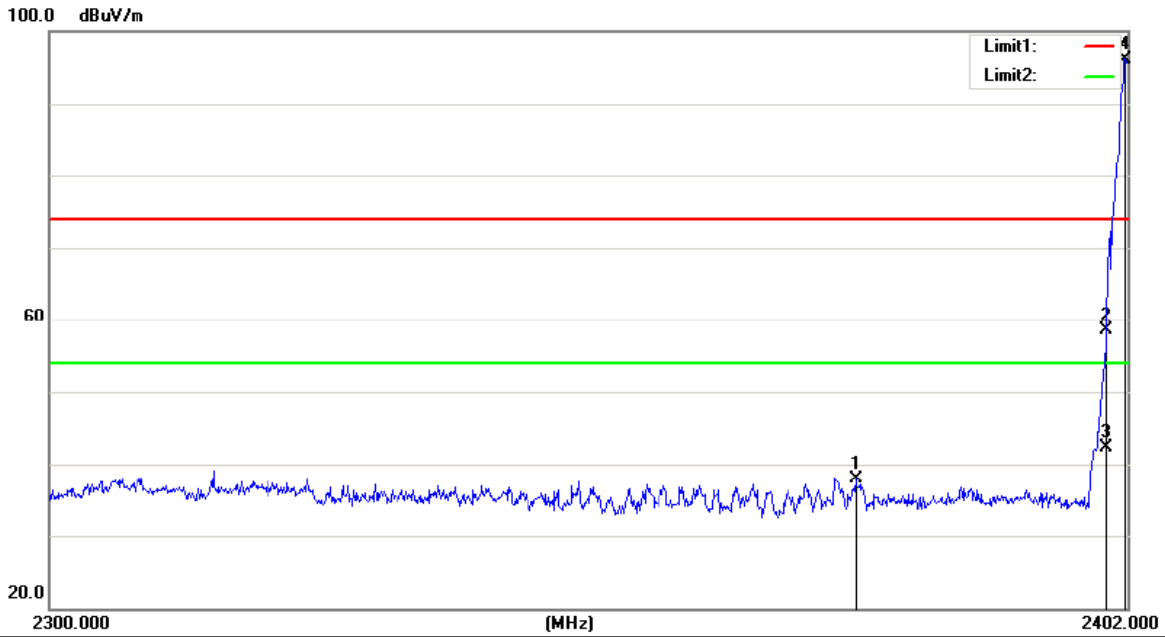

Site site #1 Polarization: **Vertical** Temperature: 26  
 Limit: (RE)FCC PART 15 C 3m\_PEAK Power: Battery 3.7V Humidity: 55 %  
 Mode: Hopping  
 Note:

No.	Mk.	Freq.	Reading Level	Correct Factor	Measurement	Limit	Over	Antenna Height	Table Degree	Comment
		MHz	dBuV	dB	dBuV/m	dBuV/m	dB	cm	degree	
1		2375.888	57.78	-19.92	37.86	74.00	-36.14	peak	0	
2		2400.000	78.22	-19.77	58.45	74.00	-15.55	peak	0	
3		2400.000	62.10	-19.77	42.33	54.00	-11.67	AVG	0	
4	*	2401.796	115.96	-19.76	96.20	74.00	22.20	peak	0	



Report No.: EA21070082F01001

72 of 78

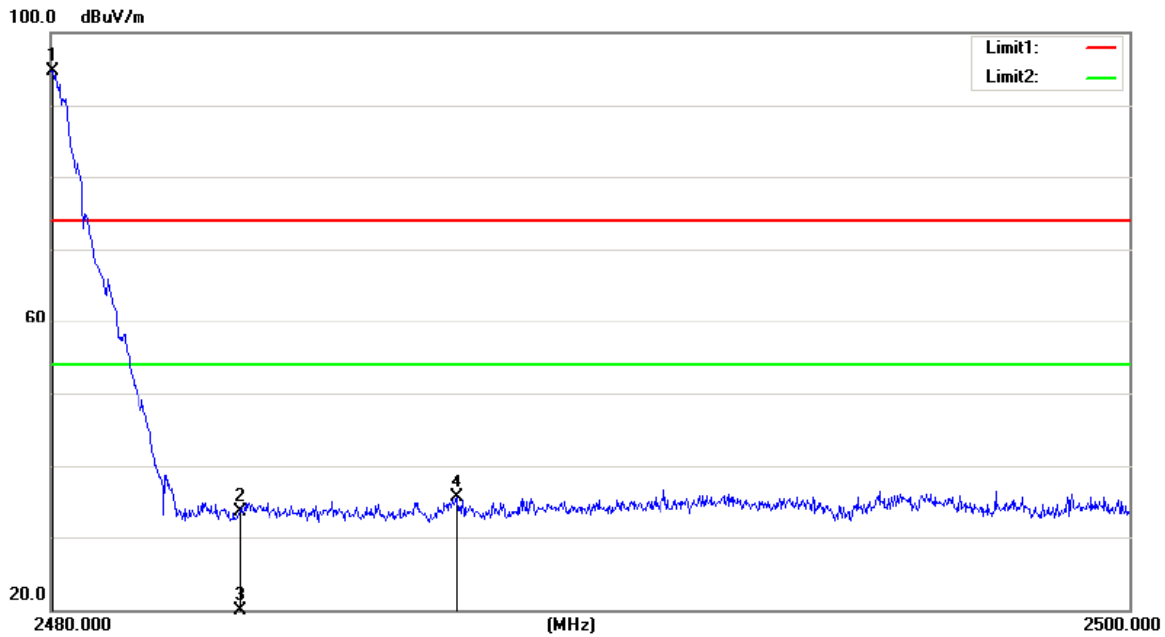

Site site #1 Polarization: **Horizontal** Temperature: 26  
 Limit: (RE)FCC PART 15 C 3m\_PEAK Power: Battery 3.7V Humidity: 55 %  
 Mode: Hopping  
 Note:

No.	Mk.	Freq. MHz	Reading Level dBuV	Correct Factor dB	Measure- ment dBuV/m	Limit dBuV/m	Over dB	Antenna Height cm	Table Degree	Comment
1	*	2480.040	115.34	-20.71	94.63	74.00	20.63	peak	0	
2		2483.500	54.27	-20.72	33.55	74.00	-40.45	peak	0	
3		2483.500	37.14	-20.72	16.42	54.00	-37.58	AVG	0	
4		2487.520	56.27	-20.70	35.57	74.00	-38.43	peak	0	



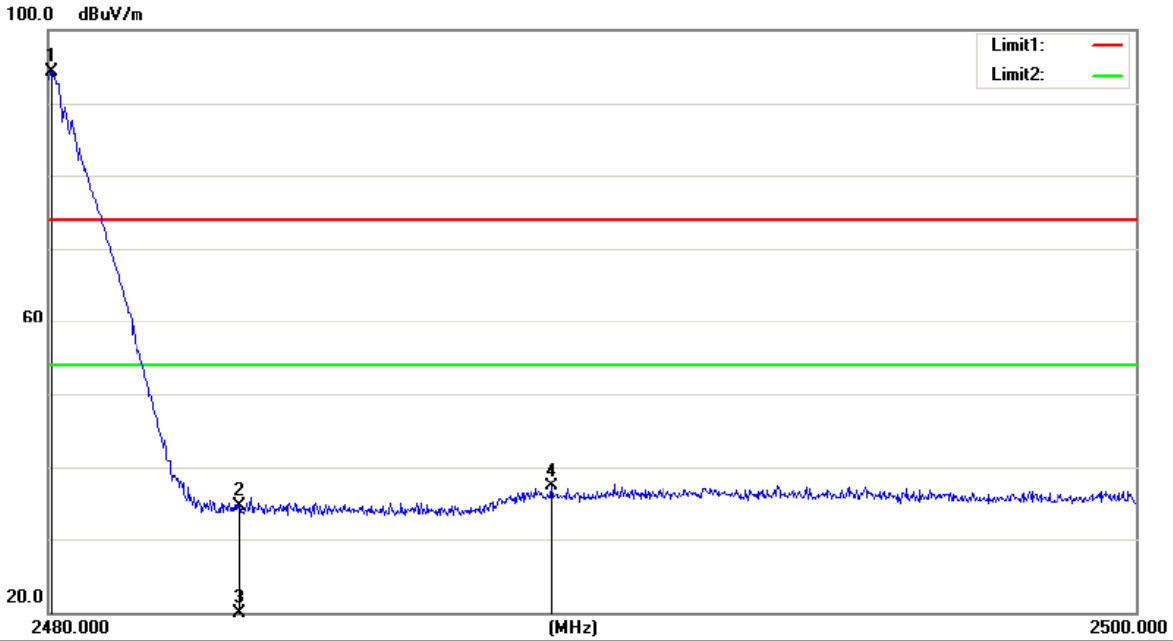

Site site #1 Polarization: *Vertical* Temperature: 26  
 Limit: (RE)FCC PART 15 C 3m\_PEAK Power: Battery 3.7V Humidity: 55 %  
 Mode:Hopping  
 Note:

No.	Mk.	Freq. MHz	Reading Level dBuV	Correct Factor dB	Measure- ment dBuV/m	Limit dBuV/m	Over dB	Antenna Height cm	Table Degree	Comment
1	*	2480.060	113.50	-19.28	94.22	74.00	20.22	peak	0	
2		2483.500	53.87	-19.27	34.60	74.00	-39.40	peak	0	
3		2483.500	37.14	-19.27	17.87	54.00	-36.13	AVG	0	
4		2489.260	56.46	-19.23	37.23	74.00	-36.77	peak	0	

## **14. Antenna Application**

### **14.1 Antenna requirement**

The EUT'S antenna is met the requirement of FCC part 15C section 15.203 and 15.247.

FCC part 15C section 15.247 requirements:

Systems operating in the 2402-2480MHz band that are used exclusively for fixed, point-to-point operations may employ transmitting antennas with directional gain greater than 6dBi provided the maximum peak output power of the intentional radiator is reduced by 1dB for every 3dB that the directional gain of the antenna exceeds 6dBi.

### **14.2 Result**

The EUT's antenna, permanent attached antenna, used a PCB antenna and integrated on PCB, The antenna's gain is 0dBi and meets the requirement.

**15. Photos of EUT**

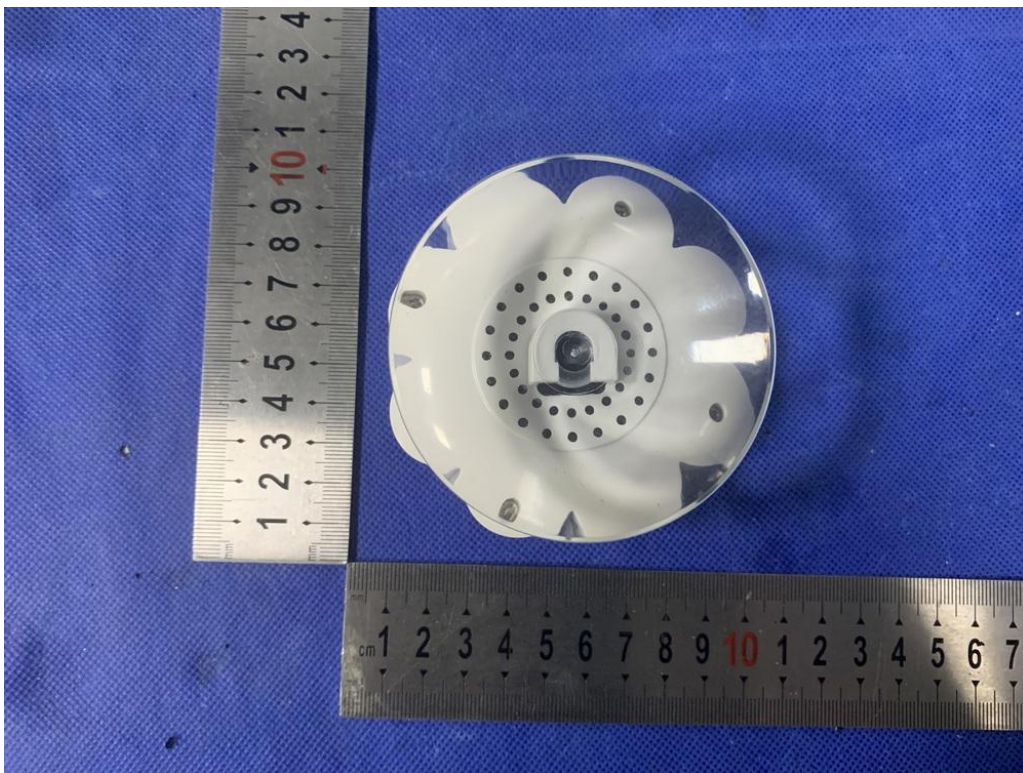



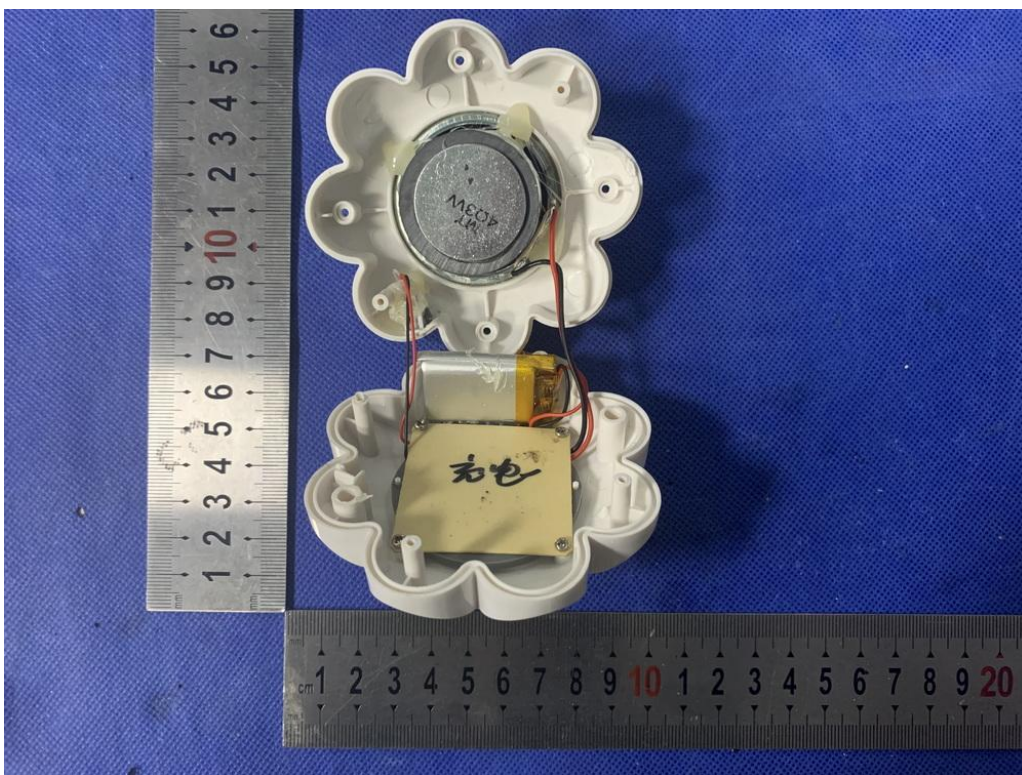
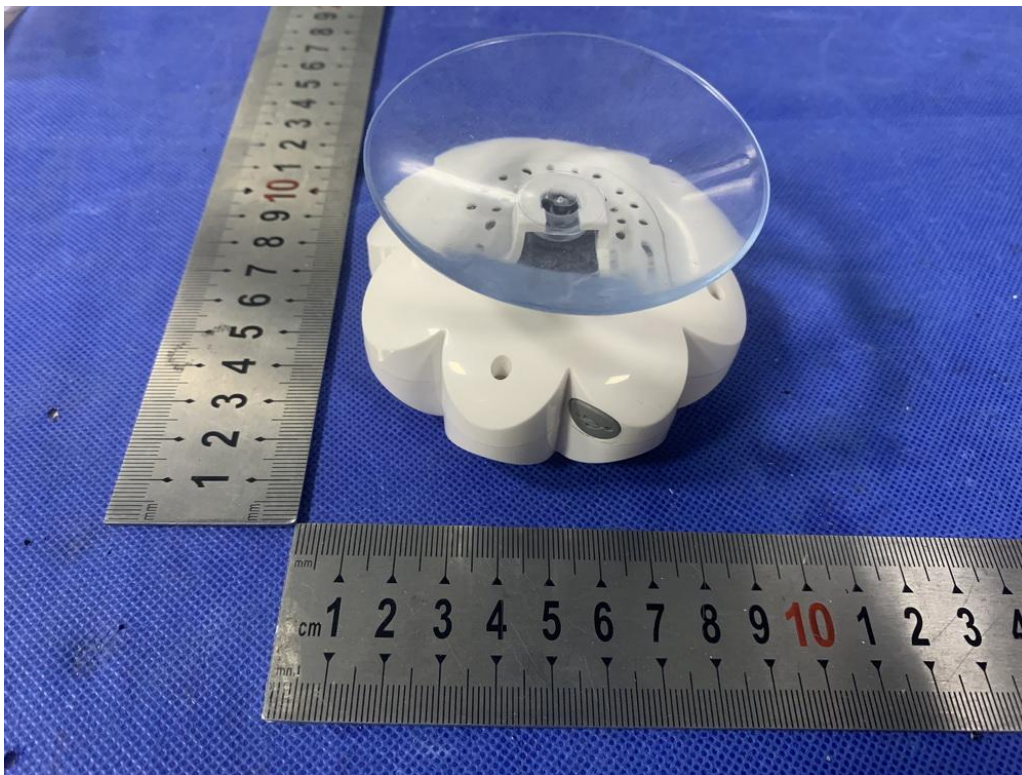



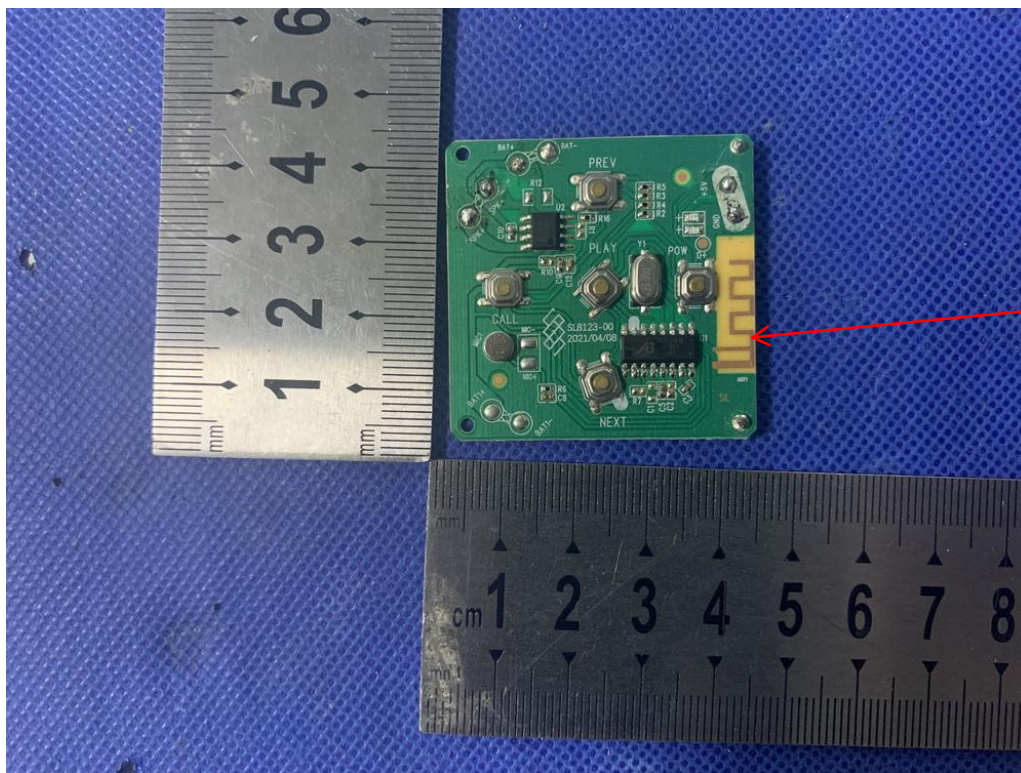

ANT

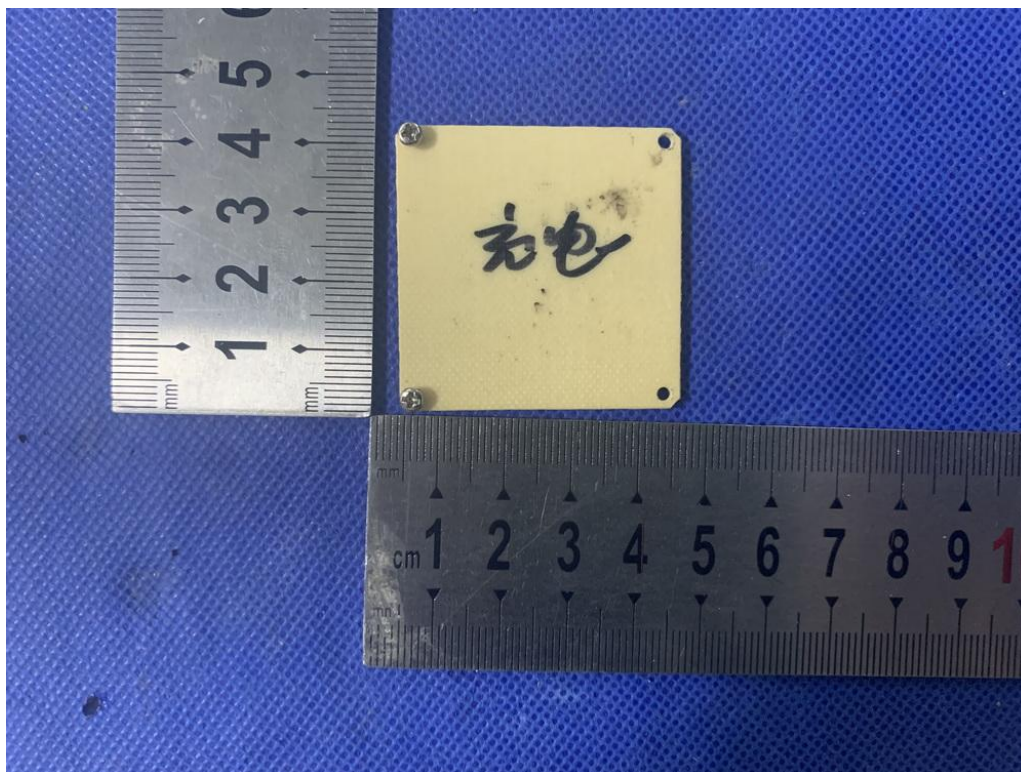

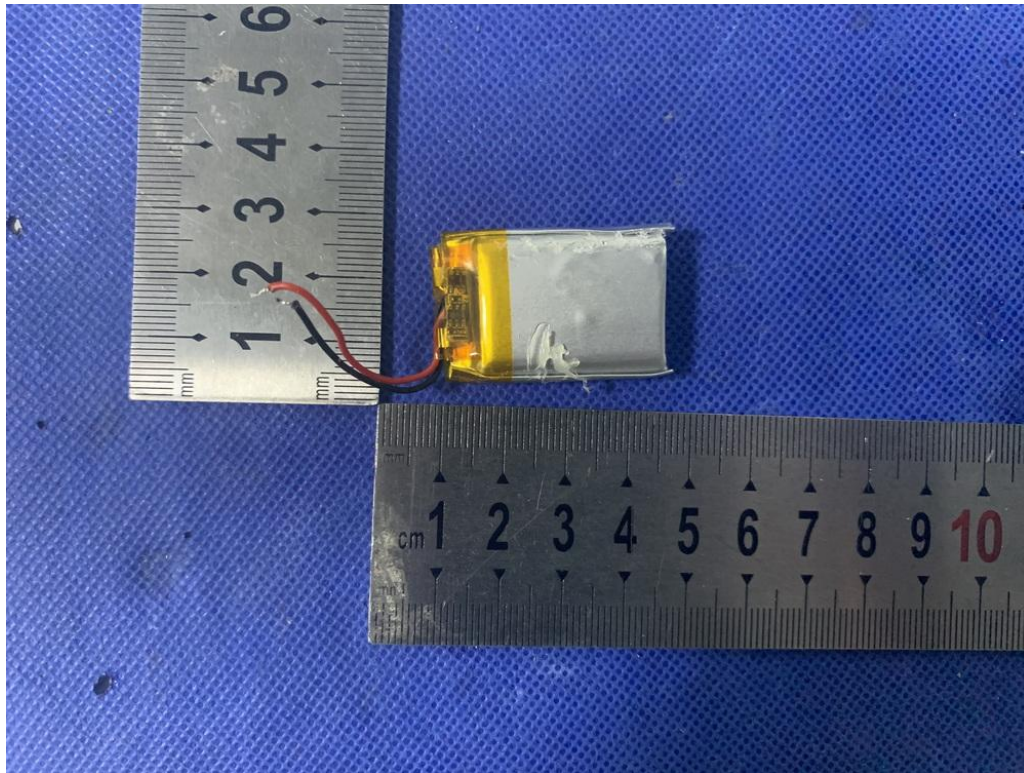

-----The end of Report-----