

# BEEPRT

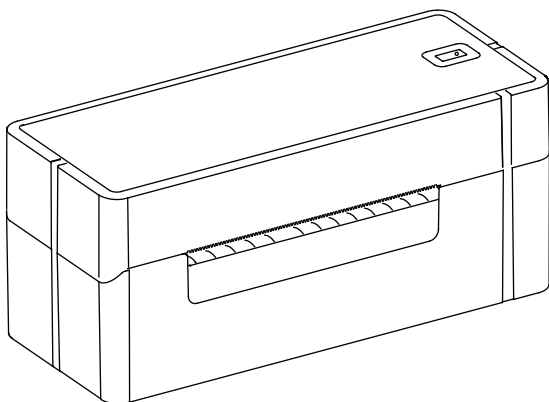

## Thermal Label Printer

Applicable models:  
BY-248W

# User Manual

Version: 1.0

# Thanks for choosing us!

If you have any question or concern , support is available by email . Problems could be resolved quickly.

 [Support@beeprt.net](mailto:Support@beeprt.net)

Please visit the website  
"help.ayinprinter.com" to  
download the printer driver and  
see the installation tutorial

 Support Web: [help.ayinprinter.com](http://help.ayinprinter.com)







Scan to:  
[Help.ayinprinter.com](http://Help.ayinprinter.com)

---

## BY-480/BY-480BT English Version





(7)

-  [Install Bleeprt Seagull Driver on Windows](#)
-  [Install Bleeprt Printer Driver on Mac](#)
-  [How to print on Windows via Bluetooth?](#)
-  [How to print on Chromebook?](#)
-  [How to install App on phone?](#)

[View all 7](#)

## BY-482/BY-482BT English Version





(7)

-  [Install Bleeprt Seagull Driver on Windows](#)
-  [Install Bleeprt Printer Driver on Mac](#)
-  [How to print on Windows via Bluetooth?](#)
-  [How to print on Chromebook?](#)
-  [How to install App on phone?](#)

[View all 7](#)

## BY-244/BY-244BT English Version





(6)

-  [Install Bleeprt Seagull Driver on Windows](#)
-  [Install Bleeprt Printer Driver on Mac](#)
-  [How to print on Windows via Bluetooth?](#)
-  [How to print on Chromebook?](#)
-  [How to install App on phone?](#)

[View all 6](#)

## BY-426/BY-426BT English Version

(7)

-  [Setup Bleeprt Printer for First Use](#)
-  [Install Bleeprt Seagull Driver on Windows](#)
-  [Install Bleeprt BY-426BT Driver on Mac](#)
-  [How to print on Windows via Bluetooth?](#)
-  [How to print on Chromebook?](#)

[View all 7](#)

# Content

1. Appearance .....	1
2. Packing list .....	1
3. Printer connection .....	2
4. The suitable label size .....	3
5. How to feed label .....	3
6. Installation For Printer Driver .....	5
7. Smartphone APP Setup .....	6
8. FAQs .....	6
9. Maintenance .....	6
10. LED indicator .....	7
11. Safety tips .....	7

# 1.Appearance

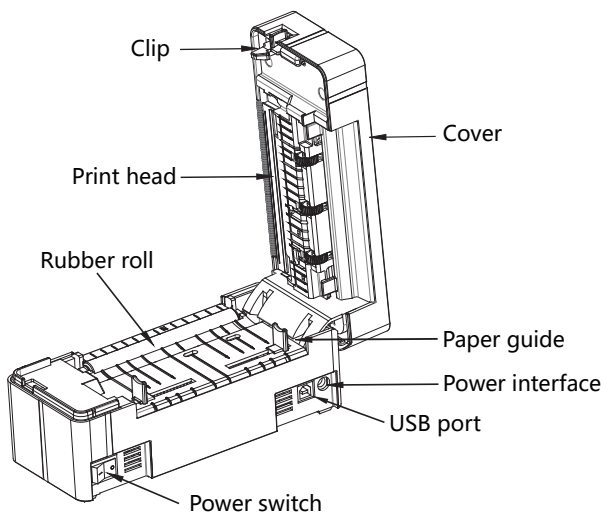

# 2. Packing list

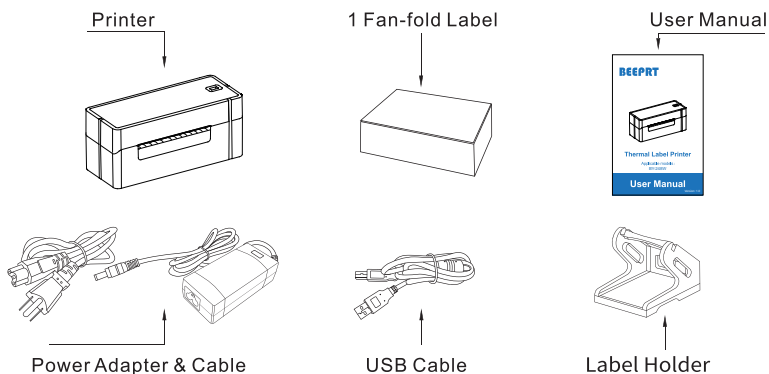

## Note:

If any accessories missing, please contact us to get support.

# 3. Printer Connection

## ⚠ Note:

- Make sure the printer's power switch is in the OFF position before connecting the power cord to printer.
- Use the original power adapter only in case the damage caused by charging improperly.
- Please unplug the printer power cord if it is not in use for a long time.

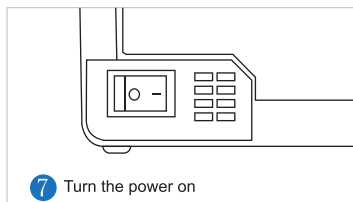
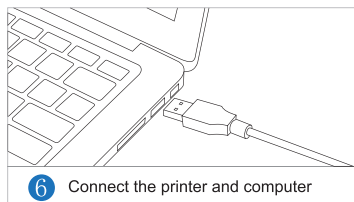
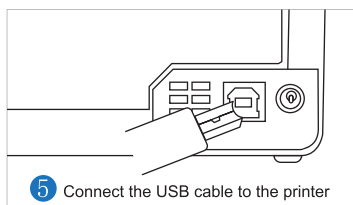
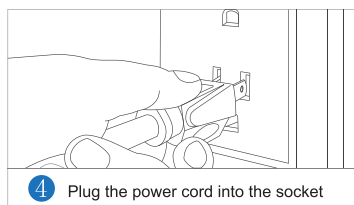
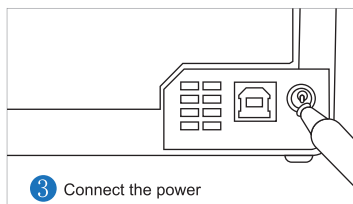
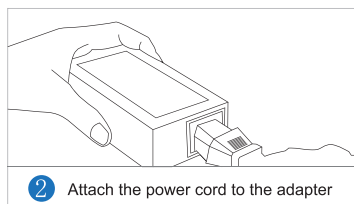
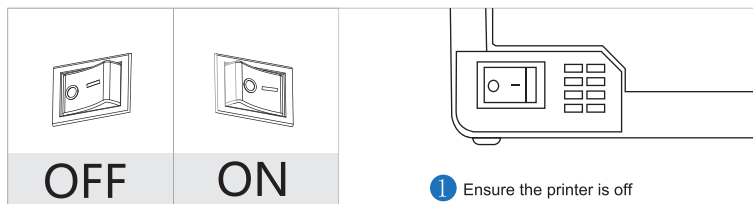

## 4.The suitable label size

- Shipping label printer works with any Thermal Direct with a width range from 1.57" to 4.1", length over 0.8". Normal paper is not applicable! Must be THERMAL LABEL!
- Ideal for 4"\*6"
- Paper size can be selected in Windows and MacBook both.

### Label standard size

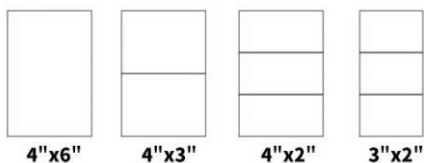

## 5.How to feed label

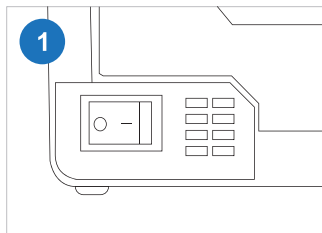

Ensure the printer is off

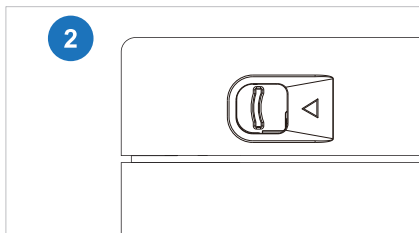

Pull the release latch to open the cover

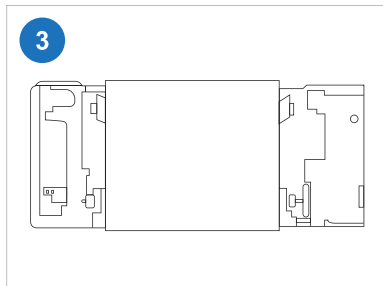

Insert the fan-fold label or roll label from outside, adjust the paper guide to fit the width of paper

 **Note:**

Ensure the print layer of label face up in case print out blank labels.

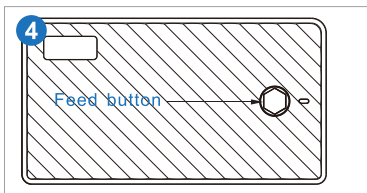

Close the cover, switch on the printer and wait 5 seconds for the printer to initialize. Long press the feed button until you hear one beep, release your finger, the label calibrates automatically and will be positioned at the tear-off point, then ready to print.

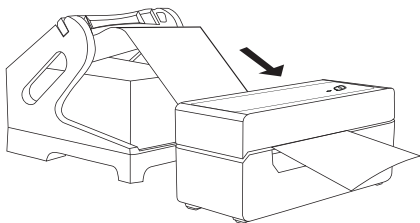

Fan-fold Type Label Loading

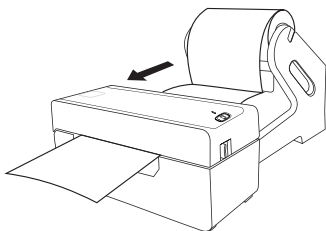

Roll Type Label Loading

**! Note:**

- Each time you change the label, please follow the above steps 5.1~5.4. Otherwise, it may cause printing out misaligned or blank.
- Everytime you open the label cover even you never change the paper, you'd better to press the feed button once to load one sheet paper.

# 6. Installation For Printer Driver

## 6.1 Install Beepert Driver on Windows



Scan the code to watch the windows driver installation video.

## 6.2 Installation For Windows via Bluetooth



Scan the code to watch the windows bluetooth installation video.

## 6.3 Installation For MacOS via USB Port



Scan the code to watch the MacOS Driver installation video.

Note: The printer Bluetooth does not support MacOS computers. Please use USB Port.

## 6.4 Installation For Chromebook via USB Port



Scan the code to watch the Chromebook Driver installation video.



# 7.Smartphone APP Setup

Please search for “Shipping Printer Pro” in your APP store and install it.



Scan the code to watch the video of APP usage.

# 8.FAQs



You can scan the code or visit the website ( [help.ayinprinter.com](http://help.ayinprinter.com) ) to view the FAQs.

# 9.Maintanance

## CLEANING THE PRINT HEAD

The printer head is a sensitive part of the printer and can be found on the upper part of the printer when open.

Caution:While the printer is running the printer head can be very hot.

- 1.Ensure that the power switch is OFF,remove the power cord,and open the cover . wait several moments to ensure that the printerhead cools down.
- 2.Completely clean the printer head using an alcohol swab like the one provided.  
Any 70% Isopropyl Alcohol pad would work . Please do not use water.
- 3.Wait 2-3minutes until the alcohol has completely dried, then close the cover.
- 4.Connect the power cord and print a test page to check if it is clean.

## 10.LED indicator

COLOUR OR STATUS OF LED BUTTON	EXPLANATION	SOLUTION
Green	Printer is running normally	
Flashing Green	Printer Head is overheated	None. Printer will automatically resume once the printer head cools down.
Flashing Red (every 2 seconds)	1.Out of paper 2.Wrong size paper	Ensure that the labels are loaded correctly.You may need to run automatic label identification (point 6 in step4).
Flashing Red (2 times per second)	Printer cover is not fully closed	Check that the printer cover is completely closed.

## 11.Safety tips

- The printer head can become very hot after printing labels .Do not touch the printer head until it has cooled.
- Do not bend the power cord excessively or place objects on the cord. This could result in fire or electrocution.
- Keep the printer out of reach of children.
- Use only approved accessories and do not try to disassemble or repair the unit by yourself.
- Keep the printer away from water and other objects that may destroy or damage the device.
- Printer should remain unplugged when not in use for long periods of time.

## **FCC WARNING**

This device complies with part 15 of the FCC Rules. Operation is subject to the following two conditions:

- (1) this device may not cause harmful interference, and
- (2) this device must accept any interference received, including interference that may cause undesired operation. Any changes or modifications not expressly approved by the party responsible for compliance could void the user's authority to operate the equipment.

NOTE: This equipment has been tested and found to comply with the limits for a Class B digital device, pursuant to Part 15 of the FCC Rules. These limits are designed to provide reasonable protection against harmful interference in a residential installation. This equipment generates, uses and can radiate radio frequency energy and, if not installed and used in accordance with the instructions, may cause harmful interference to radio communications. However, there is no guarantee that interference will not occur in a particular installation. If this equipment does cause harmful interference to radio or television reception, which can be determined by turning the equipment off and on, the user is encouraged to try to correct the interference by one or more of the following measures:

- Reorient or relocate the receiving antenna.
- Increase the separation between the equipment and receiver.
- Connect the equipment into an outlet on a circuit different from that to which the receiver is connected.
- Consult the dealer or an experienced radio/TV technician for help.

To maintain compliance with FCC's RF Exposure guidelines, This equipment should be installed and operated with minimum distance between 20cm the radiator your body: Use only the supplied antenna.

# **BEEPRT SUPPORT**

## **Still have a question or concern?**

Most issues can be resolved very quickly!  
Customer service support is available by

## **Please kindly contact us**

Index: [www.beeprt.net](http://www.beeprt.net)  
Driver: [help.ayinprinter.com](http://help.ayinprinter.com)  
E-mail: [support@beeprt.net](mailto:support@beeprt.net)



WhatsApp  
After-sales service