



10.1" Tablet

Model: tablet

PRODUCT GUIDE

We 'd love to hear from you. Scan with your app and let us know what you think.

Introduction

Thank you for purchasing. Android™10 (Go Edition) tablet with Google Play. Featuring a fast and responsive quad core processor, this tablet is perfect for accomplishing everyday tasks, streaming music and movies, taking photos, checking emails, and engaging with social media.

The tablet offers 32GB of internal storage, Bluetooth connectivity, Micro SD slot for up to 128GB of additional storage, on-the-go productivity services.

The following information will help you get the most out of your tablet.

What You Should Know to Ensure Best Performance:

- Charge the battery completely before first use.
- While updates download in the background, tablet performance can be affected until completed.
- Close unused applications. Open apps that run in the background will affect overall performance.
- Battery Consumption: Play times on a fully charged battery will vary depending on your display settings, apps that remain open, and internet use (e.g., streaming video content).
- It is recommended to use a tablet screen protector and tablet case to protect the tablets.

In The Box

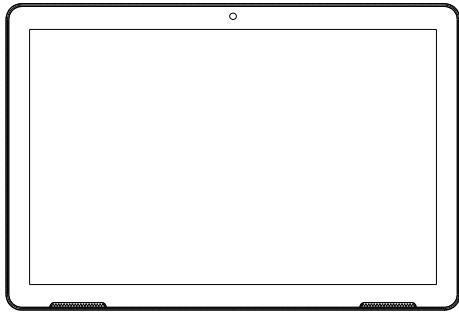

10.1" tablet

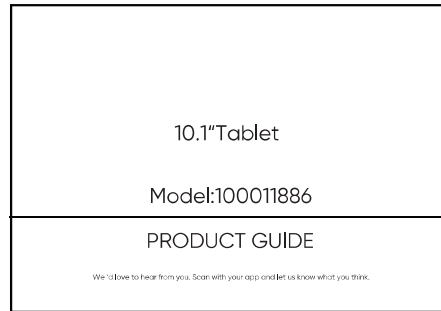

User Manual

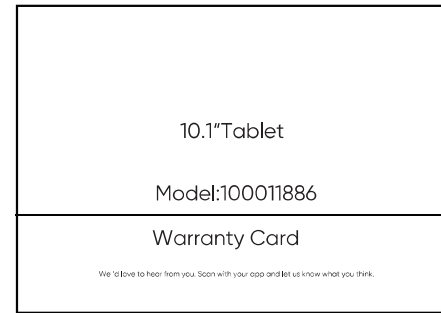

Warranty

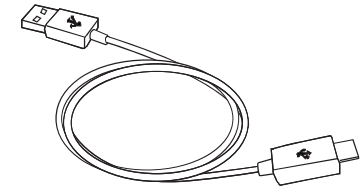

USB-C cable

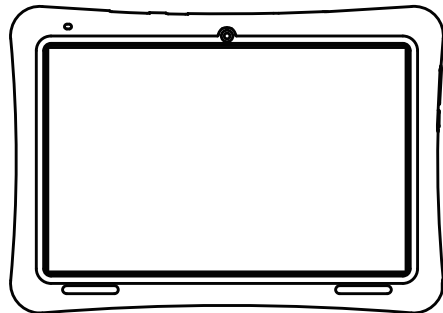

Silicone case

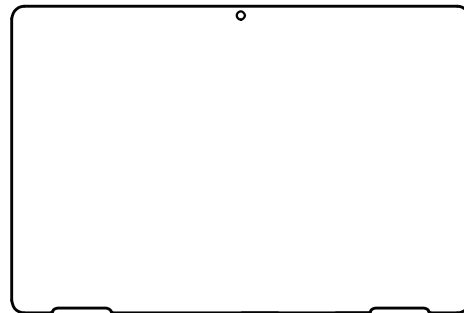

protective film

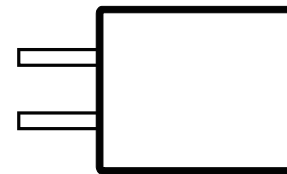

Charger

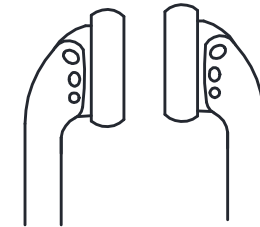

earphone

size:61*41*24mm

Input: 100-240V~50/60Hz,0.3A

Output:5.0V \equiv 2.0A

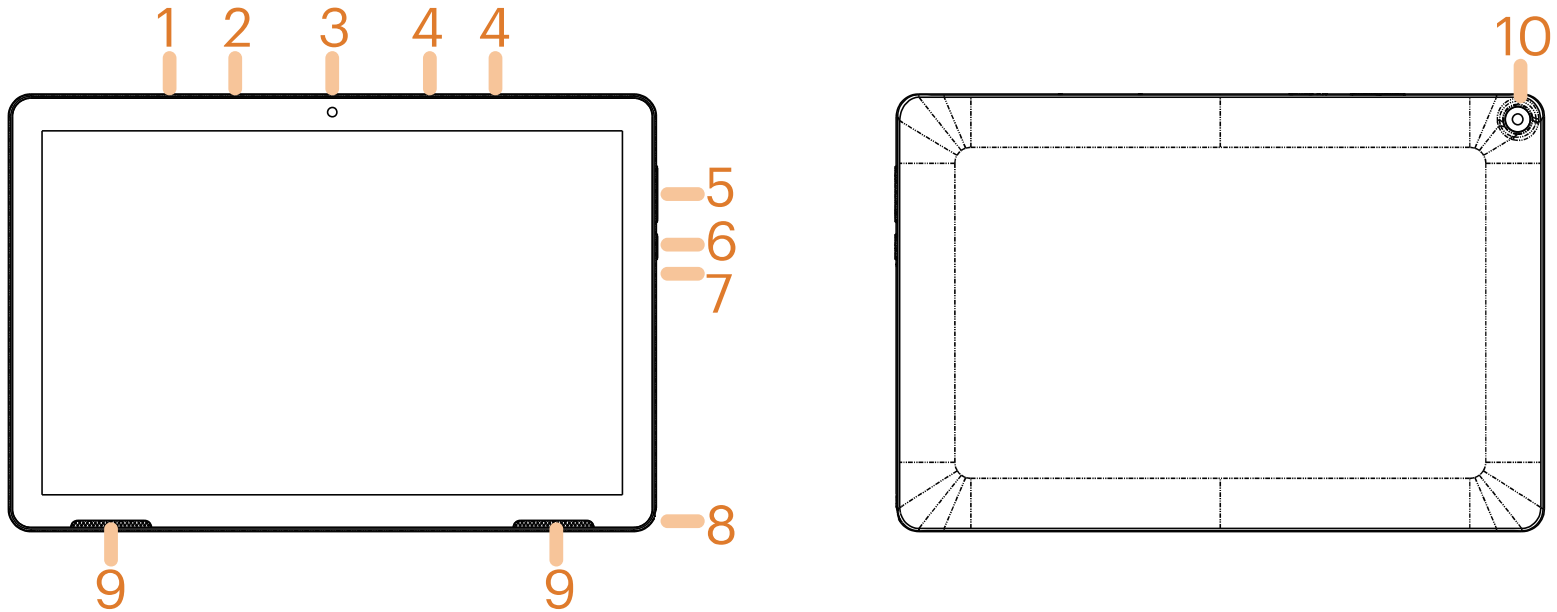

1. Micro SD Slot

2. USB-C Port

3. Camera (Front)

4. Microphone

5. Volume Control

6. Power On/off

7. Reset

8. Earphone

9. Speakers

10. Camera (Rear)

Starting Your Tablet

1. Press and hold the Power button for 3~4 seconds.
(If your tablet does not turn on, or instructs you to "Connect your charger" , connect the AC adapter and charge the unit.)
2. At the Start-up screen, swipe up from the bottom of the screen to unlock.

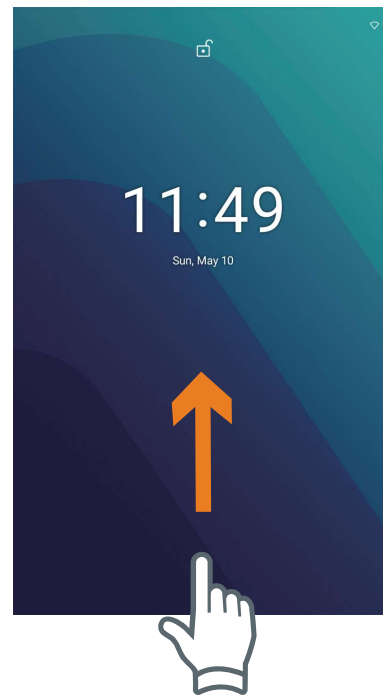

3. Once you' ve arrived at the Home screen, you can begin using your tablet.

Home Screen At-a-Glance

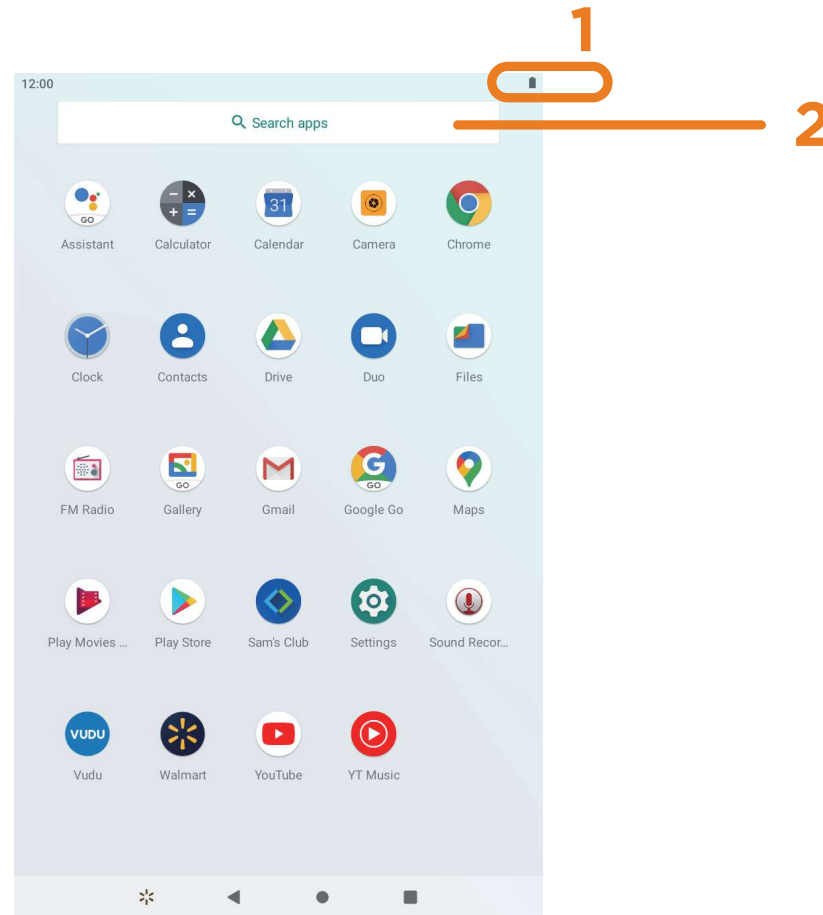

1. Status Bar
2. Search Box
3. Walmart App Suite

4. Go Back
5. Home
6. Recents

Using the Cameras



Tap on the Camera Icon

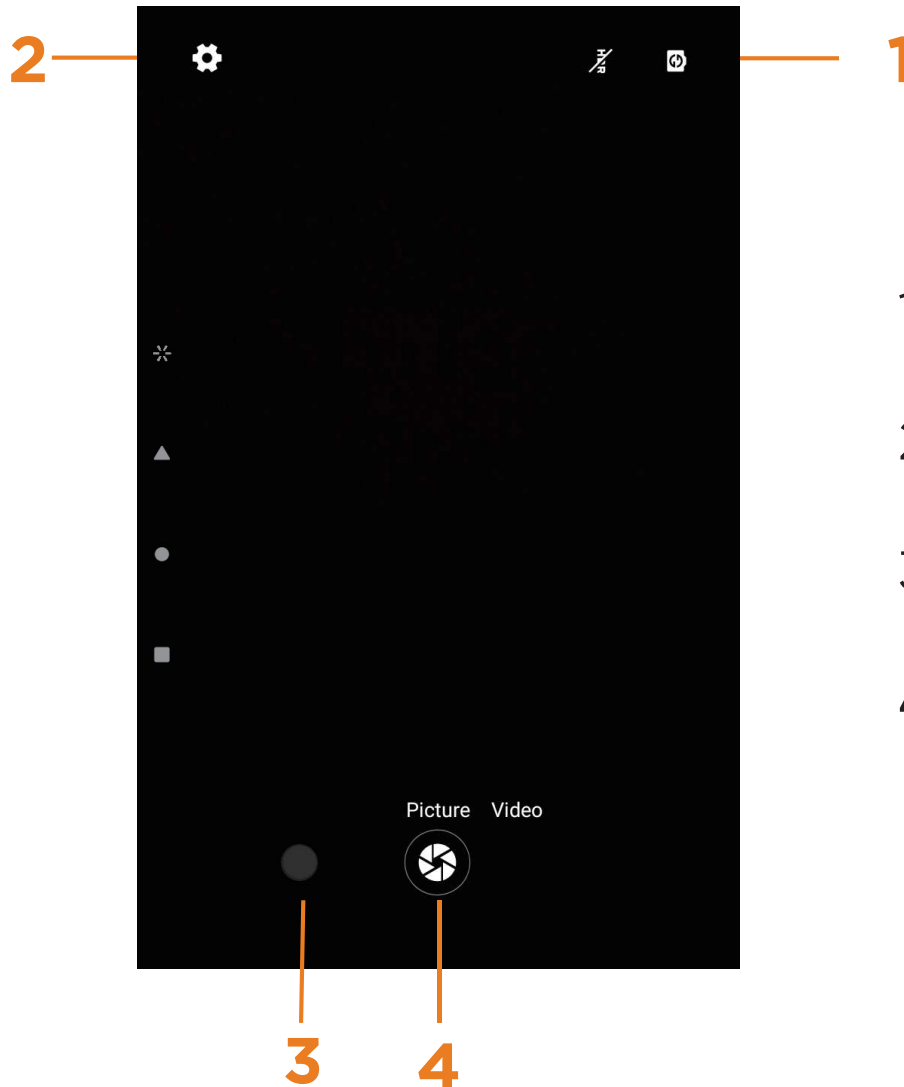

1.Switch Cameras (Front/Rear)

2.Camera Settings

3.Recent Photo

4.Take Photo

Tablet Updates

To ensure the tablet runs smoothly it is recommended to perform periodic system software updates, especially during initial set up of the tablet. You may receive notifications (on the Lock screen) from time to time that software updates are available. Tap the notification to be directed to the update. Other options to access updates:

Tap on Settings  > About Tablet > Wireless Update.

NOTE: To perform an update, you must be connected to WiFi.

Google Play Updates

The first time you sign in on Google Play, updates will automatically start downloading on to the tablet. The download icon  will appear in the status bar at the top left of screen. Installing a new application while multiple apps are downloading will reduce tablet speed and performance. After all downloads and updates have been installed, the tablet will resume normal operating performance.

To view the progress of downloads working in the background, swipe down from the top edge of the screen.

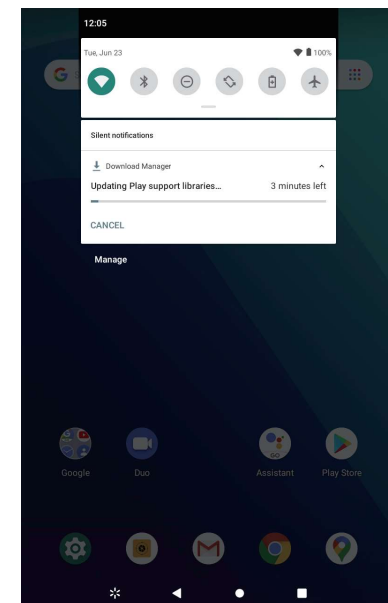
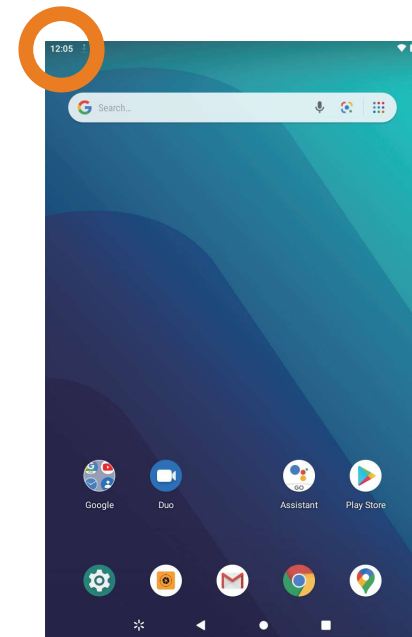

Touching and Typing



To select an item on the screen, simply tap it once with your fingertip. Some items may require you to "double-tap".



To type in to a text field (e.g., when inputting your name, or a web address), tap the text field. The on-screen keyboard will appear, and allow you to type the information you wish to enter.



Touch and Hold: Keep your finger on an on-screen item until it glows or activates an alternate menu.



Drag: Move an App or object by touching and holding the image, then moving it to the destination.

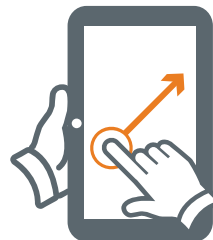

Slide: When there are extra "screens" to the side, slide one or more fingers from one side to another.

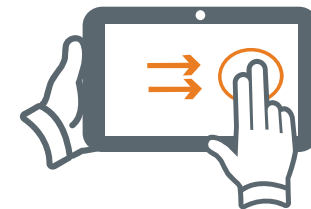

Connecting to the Internet



Wireless Router

In order to connect to the internet, you will need the following:

- A wireless router or an access point with a broadband internet connection.
- The name of your network (SSID), as well as the password or other credentials, if your network is secure.

The wireless router must support WiFi 802.11 a/b/g/n/ac connections.

Go to SETTINGS > Network & internet > WiFi

Tap on WiFi to activate wireless connectivity. The Tablet will scan for available WiFi networks within range. Secured networks will require a password. Once you have successfully entered your information the tablet will remember your settings.

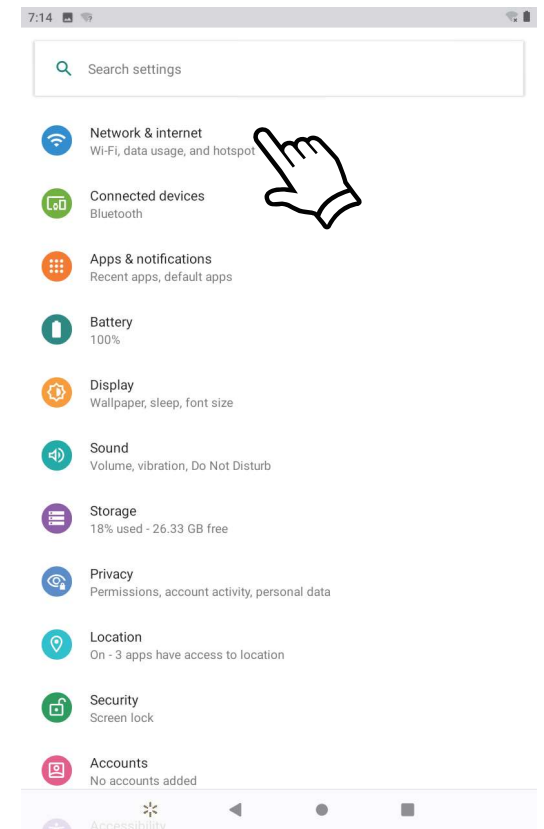

Connecting Bluetooth

Your Tablet is compatible with Bluetooth capable devices. Once your tablet searches and finds the Bluetooth device, follow on-screen instructions to initiate the pairing of the device with the Tablet. Add or "pair" a Bluetooth compatible device with your Tablet as follows:

- 1) Turn on the compatible Bluetooth device and make it discoverable.
- 2) Open the Settings > Connected devices.
- 3) Tap on Pair new device to view available devices.

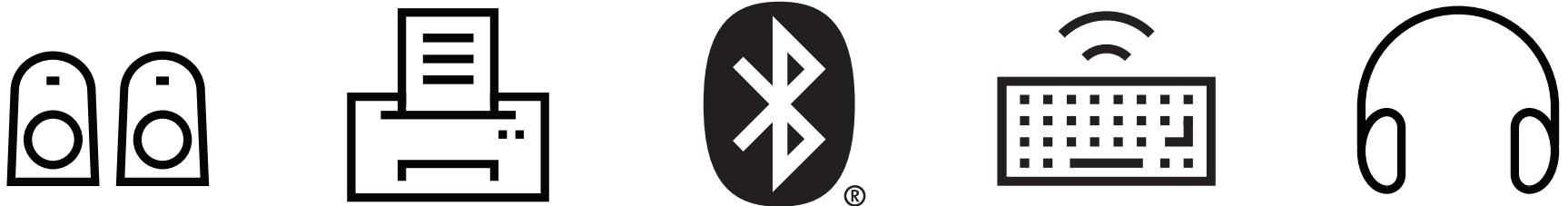

Charging Your Tablet

It is recommended to fully charge the tablet before first use. To charge the tablet, 1) plug the USB cable into the AC adapter, 2) attach the other end to the USB-C input on the tablet, 3) plug the AC adapter into a wall outlet.

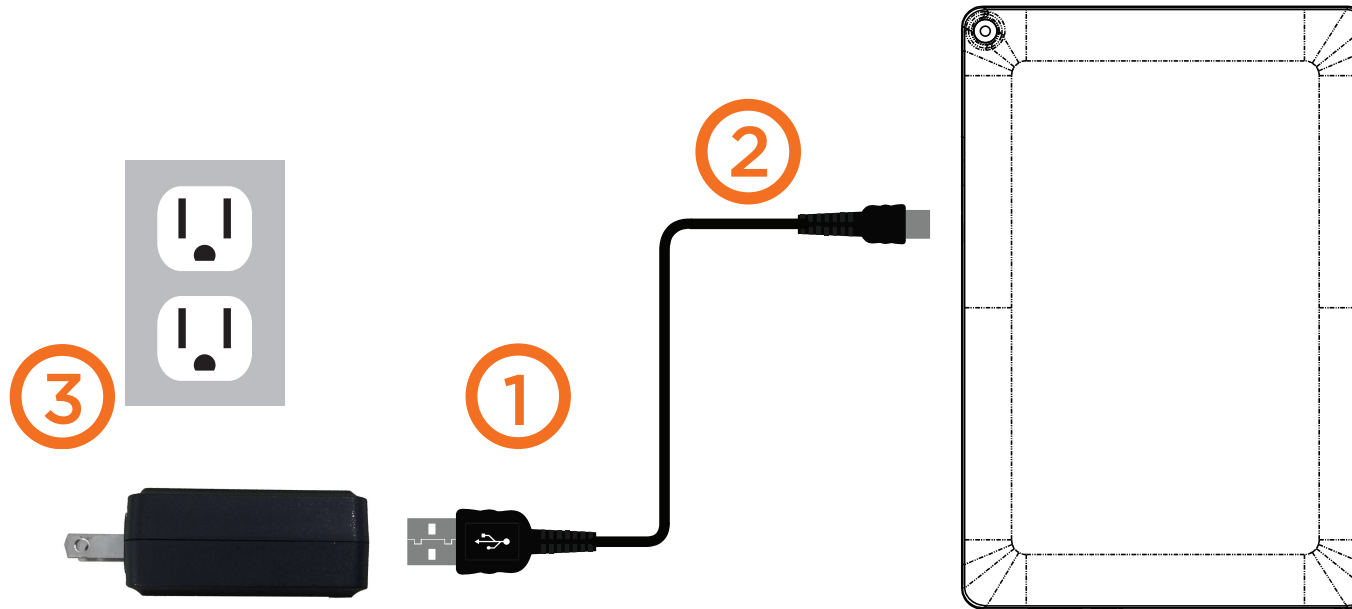

When the tablet is ON and charging, the battery icon will pulsate. A complete battery charge may take up to 3 hours. It is normal for the tablet to get warm while charging, playing games, or streaming video. Battery life will vary depending on usage.

Note: Leave tablet in a well ventilated area while charging.

Important Safety Instructions

1. Do not install near any heat sources such as radiators, heat registers, stoves, or other apparatus (including amplifiers) that produce heat.
2. **WARNING:** Only use attachments/accessories specified or provided by the manufacturer (such as the exclusive supply adapter, battery etc).
3. **WARNING:** The mains plug should be kept in a state that can be disconnected at anytime to avoid emergency situation.
4. **WARNING:** The apparatus should not be exposed to dripping or splashing. Objects filled with liquids, such as vases or drinking glasses, should not be placed on the apparatus.
5. **WARNING:** Please refer the electrical and safety information on tablet and user manual before installing or operating the apparatus.

Use the device where the ambient temperature is between 0° and 35° C (32° to 95° F). Low- or high-temperature conditions might cause the device to change its behavior to regulate its temperature. Using your tablet in very cold conditions outside of its operating range might temporarily shorten the battery life and could cause the device to turn off. Battery life will return to normal when you bring the device back to higher ambient temperatures. Using the device in very hot conditions can permanently shorten battery life.

Important Safety Instructions

We would like you to have a safe and enjoyable experience.

Please read the following instructions and notices before using your tablet.

- Warning: This product may contain a chemical known to the State of California to cause cancer, birth defects, or other reproductive harm.
- Avoid using the tablet in extremely hot, cold, dusty, damp or wet environments.
- The tablet is not moisture/water-resistant. Avoid using the tablet around sources of water.
- Avoid dropping or forcibly placing the tablet onto a hard surface. This may damage the screen or internal electronic components and void the warranty.
- Do not use alcohol, thinner or benzene to clean the surface of the tablet. Use only cleaning products designed for computer tablet devices.
- Do not use the tablet while walking or driving.
- Excessive use of earphones at high volume may lead to hearing impairment. Limit earphone usage, and adjust the volume to a moderate level when doing so.
- The images in this guide may vary slightly from the actual product.
- Charge the tablet battery under any of the following circumstances:
 1. The battery level icon indicates low power, by showing a drained, red battery icon.
 2. The tablet powers-off automatically, and continues to do so even after restarting.
 3. On-screen keys do not work.
- Do not suddenly disconnect the tablet when formatting, uploading or downloading data. This can lead to program errors (e.g., system or screen "freezing" .)
- Static discharge is normal and can occur in an electronic device although not life threatening, it may corrupt files or damage memory and its content.
- Dismantling the tablet will void the manufacturer' s warranty.
- The tablet functions, hardware, software, and warranty information may be improved or modified by the manufacturer or their respective owners, and is subject to change without notice.



FCC statement

This device complies with Part 15 of the FCC Rules. Operation is subject to the following two conditions: (1) This device may not cause harmful interference, and (2) this device must accept any interference received, including interference that may cause undesired operation.

Caution: Changes or modifications not expressly approved by the party responsible for compliance could void the user's authority to operate the equipment.

NOTE: This equipment has been tested and found to comply with the limits for a Class B digital device, pursuant to part 15 of the FCC Rules. These limits are designed to provide reasonable protection against harmful interference in a residential installation. This equipment generates, uses and can radiate radio frequency energy and, if not installed and used in accordance with the instructions, may cause harmful interference to radio communications. However, there is no guarantee that interference will not occur in a particular installation. If this equipment does cause harmful interference to radio or television reception, which can be determined by turning the equipment off and on, the user is encouraged to try to correct the interference by one or more of the following measures:

- Reorient or relocate the receiving antenna.
- Increase the separation between the equipment and receiver.
- Connect the equipment into an outlet on a circuit different from that to which the receiver is connected.
- Consult the dealer or an experienced radio/TV technician for help.

Specific Absorption Rate (SAR) information:

This Tablet meets the government's requirements for exposure to radio waves. The guidelines are based on standards that were developed by independent scientific organizations through periodic and thorough evaluation of scientific studies. The standards include a substantial safety margin designed to assure the safety of all persons regardless of age or health. FCC RF Exposure Information and Statement the SAR limit of USA (FCC) is 1.6 W/kg averaged over one gram of tissue. Device types: Tablet has also been tested against this SAR limit. This device was tested for typical body-worn operations with the back of the phone kept 0mm from the body. To maintain compliance with FCC RF exposure requirements, use accessories that maintain an 0mm separation distance between the user's body and the back of the phone. The use of belt clips, holsters and similar accessories should not contain metallic components in its assembly. The use of accessories that do not satisfy these requirements may not comply with FCC RF exposure requirements, and should be avoided.