



Shenzhen GUOREN Certification Technology Service Co., Ltd.

101#, Building K & Building T, The Second Industrial Zone, Jiazitang Community, Fenghuang Street, Guangming District, Shenzhen, China

FCC PART 15 SUBPART C TEST REPORT

FCC PART 15.225

Report Reference No..... : GRCTR231002015-03

FCC ID..... : 2A2CY-HCYS010

Compiled by
(position+printed name+signature)..: Testing Engineer Jimmy Wang



Supervised by
(position+printed name+signature)..: Project Engineer Kelley Zhang



Approved by
(position+printed name+signature)..: Manager Sam Wang

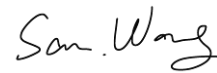

Date of issue.....: Dec. 05, 2023

Testing Laboratory Name..... : Shenzhen GUOREN Certification Technology Service Co., Ltd.

Address.....: 101#, Building K & Building T, The Second Industrial Zone, Jiazitang Community, Fenghuang Street, Guangming District, Shenzhen, China

Applicant's name..... : Shenzhen Hechuang Yousu Trade co., Ltd.

Address.....: Room 3408, Building 6, 2nd-stage Project, Tianan Yungu Industrial Park, Bantian Street, Longgang District, Shenzhen, China

Test specification..... :

Standard.....: **FCC Part 15.225**

Shenzhen GUOREN Certification Technology Service Co., Ltd. All rights reserved.

This publication may be reproduced in whole or in part for non-commercial purposes as long as the Shenzhen GUOREN Certification Technology Service Co., Ltd. is acknowledged as copyright owner and source of the material. Shenzhen GUOREN Certification Technology Service Co., Ltd. takes no responsibility for and will not assume liability for damages resulting from the reader's interpretation of the reproduced material due to its placement and context.

Test item description..... : 48A EV Charger

Trade Mark.....: AutoBot

Manufacturer.....: Shenzhen Yuxin iot Technology Co.,LTD.

Model/Type reference.....: A08-US48A

Listed Models: A08-US40A

Modulation Type.....: ASK

Operation Frequency.....: 13.56MHz

Rating.....: AC 200~240V 60Hz

Result.....: **PASS**

TEST REPORT

Equipment under Test : 48A EV Charger

Model /Type : A08-US48A

Listed Models : A08-US40A

Applicant : **Shenzhen Hechuang Yousu Trade co., Ltd.**

Address : Room 3408, Building 6, 2nd-stage Project, Tianan Yungu Industrial Park, Bantian Street, Longgang District, Shenzhen, China

Manufacturer : **Shenzhen Yuxin iot Technology Co.,LTD.**

Address : 201, No. 5, Xiangxing Paper Products Factory, No. 3 Liuxian Third Road, Xingdong Community, Xin'an Street, Bao'an District, Shenzhen

| | |
|---------------------|-------------|
| Test Result: | PASS |
|---------------------|-------------|

The test report merely corresponds to the test sample.
It is not permitted to copy extracts of these test result without the written permission of the test laboratory.

Contents

| | |
|---|-----------|
| 1 TEST STANDARDS | 4 |
| 2 SUMMARY | 5 |
| 2.1 General Remarks | 5 |
| 2.2 Product Description | 5 |
| 2.3 Equipment Under Test | 5 |
| 2.4 Short description of the Equipment under Test (EUT) | 5 |
| 2.5 Block Diagram of Test Setup | 6 |
| 2.6 Related Submittal(s) / Grant (s) | 6 |
| 2.7 Modifications | 6 |
| 3 TEST ENVIRONMENT | 7 |
| 3.1 Address of the test laboratory | 7 |
| 3.2 Test Facility | 7 |
| 3.3 Environmental conditions | 7 |
| 3.4 Test Description | 8 |
| 3.5 Statement of the measurement uncertainty | 8 |
| 3.6 Equipments Used during the Test | 9 |
| 4 TEST CONDITIONS AND RESULTS | 10 |
| 4.1 AC Power Conducted Emission | 10 |
| 4.2 Radiated Emission | 13 |
| 4.3 20dB Bandwidth | 18 |
| 4.4 Frequency Stability | 19 |
| 5 TEST SETUP PHOTOS OF THE EUT | 21 |
| 6 PHOTOS OF THE EUT | 22 |

1 TEST STANDARDS

The tests were performed according to following standards:

[FCC Rules Part 15.225](#): Operation within the band 13.110–14.010 MHz.

[ANSI C63.10-2013](#): American National Standard for Testing Unlicensed Wireless Devices

2 SUMMARY

2.1 General Remarks

| | | |
|--------------------------------|---|---------------|
| Date of receipt of test sample | : | Oct. 18, 2023 |
| Testing commenced on | : | Oct. 18, 2023 |
| Testing concluded on | : | Dec. 05, 2023 |

2.2 Product Description

| | |
|---|---|
| Product Name: | 48A EV Charger |
| Model/Type reference: | A08-US48A |
| Listed Models | A08-US40A(The products are identical in interior structure, electrical circuits and components, just model names and color is different.) |
| Power supply: | AC 200~240V 60Hz |
| testing sample ID: | GRCTR231002015-1# (Engineer sample), GRCTR231002015-2# (Normal sample) |
| Firmware Version..... | V1.0 |
| Hardware Version..... | V1.0 |
| 13.56MHz RFID | |
| Operation frequency: | 13.56MHz |
| Modulation : | ASK |
| No. of Channel : | 1 |
| Antenna type: | PCB Antenna |
| Antenna gain: | 0.00 dBi |
| Remark:*When the information provided by the customer was used to calculate test results, if the information provided by the customer is not accurate, shenzhen GUOREN Certification Technology Service Co., Ltd. does not assume any responsibility. | |

2.3 Equipment Under Test

Power supply system utilised

| | | | |
|----------------------|---|--|-----------------------------------|
| Power supply voltage | : | <input checked="" type="radio"/> 240V / 60 Hz | <input type="radio"/> 120V / 60Hz |
| | | <input type="radio"/> 12 V DC | <input type="radio"/> 24 V DC |
| | | <input type="radio"/> Other (specified in blank below) | |

!

2.4 Short description of the Equipment under Test (EUT)

This is a 48A EV Charger.
For more details, refer to the user's manual of the EUT.

2.5 Block Diagram of Test Setup

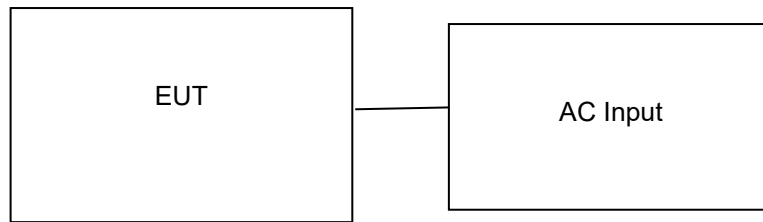

2.6 Related Submittal(s) / Grant (s)

This submittal(s) (test report) is intended for filing to comply with Section 15.247 of the FCC Part 15, Subpart C Rules.

2.7 Modifications

No modifications were implemented to meet testing criteria.

3 TEST ENVIRONMENT

3.1 Address of the test laboratory

Shenzhen GUOREN Certification Technology Service Co., Ltd.

101#, Building K & Building T, The Second Industrial Zone, Jiazitang Community, Fenghuang Street, Guangming District, Shenzhen, China

3.2 Test Facility

The test facility is recognized, certified, or accredited by the following organizations:

FCC-Registration No.: 920798 Designation Number: CN1304

Shenzhen GUOREN Certification Technology Service Co., Ltd. has been listed on the US Federal Communications Commission list of test facilities recognized to perform electromagnetic emissions measurements.

A2LA-Lab Cert. No.: 6202.01

Shenzhen GUOREN Certification Technology Service Co., Ltd. has been listed by American Association for Laboratory Accreditation to perform electromagnetic emission measurement.

ISED#: 27264 CAB identifier: CN0115

Shenzhen GUOREN Certification Technology Service Co., Ltd. has been listed by Innovation, Science and Economic Development Canada to perform electromagnetic emission measurement.

CNAS-Lab Code: L15631

Shenzhen GUOREN Certification Technology Service Co., Ltd. has been assessed and proved to be in compliance with CNAS-CL01 Accreditation Criteria for Testing and Calibration Laboratories for the Competence of Testing and Calibration Laboratories.

The 3m-Semi anechoic test site fulfils CISPR 16-1-4 according to ANSI C63.10 and CISPR 16-1-4:2010.

3.3 Environmental conditions

During the measurement the environmental conditions were within the listed ranges:

| | |
|---------------------|--------------|
| Normal Temperature: | 15-35 °C |
| Relative Humidity | 30-60 % |
| Air Pressure | 950-1050mbar |

3.4 Test Description

| FCC PART 15 .225 | | |
|----------------------------|-------------------------------|------|
| FCC Part 15.207 | AC Power Conducted Emission | PASS |
| FCC Part 2.1049 | 20dB Bandwidth | PASS |
| FCC Part 15.225(a) (b) (c) | In-band Emissions | PASS |
| FCC Part 15.225(d)/15.207 | Out-of-band Emissions | PASS |
| FCC Part 15.225(e) | Frequency Stability Tolerance | PASS |

3.5 Statement of the measurement uncertainty

The data and results referenced in this document are true and accurate. The reader is cautioned that there may be errors within the calibration limits of the equipment and facilities. The measurement uncertainty was calculated for all measurements listed in this test report acc. to TR-100028-01 "Electromagnetic compatibility and Radio spectrum Matters (ERM);Uncertainties in the measurement of mobile radio equipment characteristics; Part 1" and TR-100028-02 "Electromagnetic compatibility and Radio spectrum Matters (ERM);Uncertainties in the measurement of mobile radio equipment characteristics; Part 2 " and is documented in the Shenzhen GUOREN Certification Technology Service Co., Ltd.quality system acc. to DIN EN ISO/IEC 17025. Furthermore, component and process variability of devices similar to that tested may result in additional deviation. The manufacturer has the sole responsibility of continued compliance of the device.

Hereafter the best measurement capability for Shenzhen GUOREN Certification Technology Service Co., Ltd.:

| Test | Range | Measurement Uncertainty | Notes |
|-----------------------|------------|-------------------------|-------|
| Radiated Emission | 30~1000MHz | 4.06 dB | (1) |
| Radiated Emission | 1~18GHz | 5.14 dB | (1) |
| Radiated Emission | 18-40GHz | 5.38 dB | (1) |
| Conducted Disturbance | 0.15~30MHz | 2.14 dB | (1) |

- (1) This uncertainty represents an expanded uncertainty expressed at approximately the 95% confidence level using a coverage factor of k=2.

3.6 Equipments Used during the Test

| Test Equipment | Manufacturer | Model No. | Equipment No. | Calibration Date | Calibration Due Date |
|----------------------------|------------------------|-------------|---------------|------------------|----------------------|
| LISN | R&S | ENV216 | GRCTEE009 | 2023/09/27 | 2024/09/26 |
| LISN | R&S | ENV216 | GRCTEE010 | 2023/09/27 | 2024/09/26 |
| EMI Test Receiver | R&S | ESPI | GRCTEE017 | 2023/09/28 | 2024/09/27 |
| EMI Test Receiver | R&S | ESCI | GRCTEE008 | 2023/09/27 | 2024/09/26 |
| Spectrum Analyzer | Agilent | N9020A | GRCTEE002 | 2023/09/27 | 2024/09/26 |
| Spectrum Analyzer | R&S | FSP | GRCTEE003 | 2023/09/28 | 2024/09/27 |
| Vector Signal generator | Agilent | N5181A | GRCTEE007 | 2023/09/27 | 2024/09/26 |
| Analog Signal Generator | R&S | SML03 | GRCTEE006 | 2023/09/27 | 2024/09/26 |
| Climate Chamber | QIYA | LCD-9530 | GRCTES016 | 2023/09/27 | 2024/09/26 |
| Ultra-Broadband Antenna | Schwarzbeck | VULB9163 | GRCTEE018 | 2023/09/28 | 2026/09/27 |
| Horn Antenna | Schwarzbeck | BBHA 9120D | GRCTEE019 | 2023/09/28 | 2026/09/27 |
| Loop Antenna | Zhinan | ZN30900C | GRCTEE020 | 2023/10/15 | 2026/10/14 |
| Horn Antenna | Beijing Hangwei Dayang | OBH100400 | GRCTEE049 | 2023/09/28 | 2026/09/27 |
| Amplifier | Schwarzbeck | BBV 9745 | GRCTEE021 | 2023/09/27 | 2024/09/26 |
| Amplifier | Taiwan chengyi | EMC051845B | GRCTEE022 | 2023/09/28 | 2024/09/27 |
| Temperature/Humidity Meter | Huaguan | HG-308 | GRCTES037 | 2023/09/27 | 2024/09/26 |
| Directional coupler | NARDA | 4226-10 | GRCTEE004 | 2023/09/27 | 2024/09/26 |
| High-Pass Filter | XingBo | XBLBQ-GTA18 | GRCTEE053 | 2023/09/27 | 2024/09/26 |
| High-Pass Filter | XingBo | XBLBQ-GTA27 | GRCTEE054 | 2023/09/27 | 2024/09/26 |
| Automated filter bank | Tonscend | JS0806-F | GRCTEE055 | 2023/09/27 | 2024/09/26 |
| Power Sensor | Agilent | U2021XA | GRCTEE070 | 2023/09/27 | 2024/09/26 |
| EMI Test Software | ROHDE & SCHWARZ | ESK1-V1.71 | GRCTEE060 | N/A | N/A |
| EMI Test Software | Fera | EZ-EMC | GRCTEE061 | N/A | N/A |

4 TEST CONDITIONS AND RESULTS

4.1 AC Power Conducted Emission

TEST CONFIGURATION

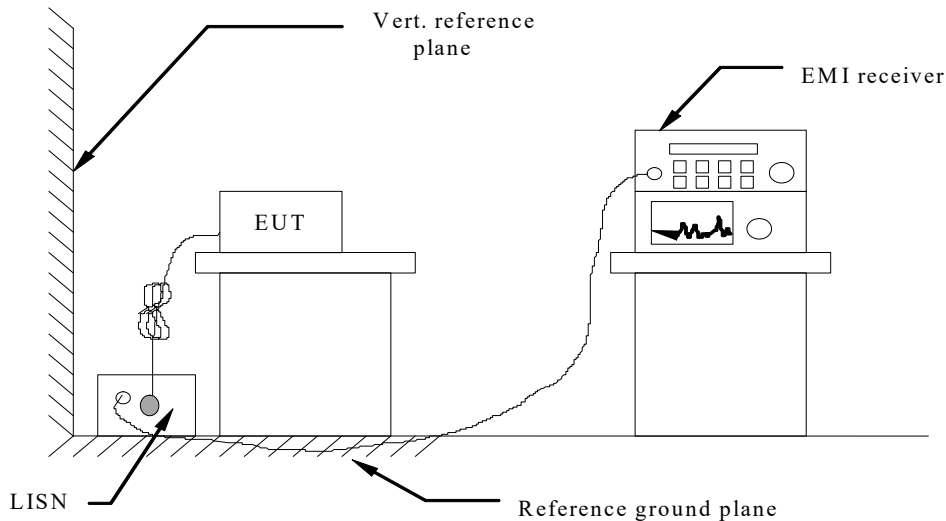

TEST PROCEDURE

- 1 The equipment was set up as per the test configuration to simulate typical actual usage per the user's manual. The EUT is a tabletop system, a wooden table with a height of 0.8 meters is used and is placed on the ground plane as per ANSI C63.10-2013.
- 2 Support equipment, if needed, was placed as per ANSI C63.10-2013
- 3 All I/O cables were positioned to simulate typical actual usage as per ANSI C63.10-2013
- 4 The EUT received power from adapter, the adapter received AC120V/60Hz and AC 240V/60Hz power through a Line Impedance Stabilization Network (LISN) which supplied power source and was grounded to the ground plane.
- 5 All support equipments received AC power from a second LISN, if any.
- 6 The EUT test program was started. Emissions were measured on each current carrying line of the EUT using a spectrum Analyzer / Receiver connected to the LISN powering the EUT. The LISN has two monitoring points: Line 1 (Hot Side) and Line 2 (Neutral Side). Two scans were taken: one with Line 1 connected to Analyzer / Receiver and Line 2 connected to a 50 ohm load; the second scan had Line 1 connected to a 50 ohm load and Line 2 connected to the Analyzer / Receiver.
- 7 Analyzer / Receiver scanned from 150 KHz to 30MHz for emissions in each of the test modes.
- 8 During the above scans, the emissions were maximized by cable manipulation.

AC Power Conducted Emission Limit

For intentional device, according to § 15.207(a) AC Power Conducted Emission Limits is as following:

| Frequency range (MHz) | Limit (dBuV) | |
|-----------------------|--------------|-----------|
| | Quasi-peak | Average |
| 0.15-0.5 | 66 to 56* | 56 to 46* |
| 0.5-5 | 56 | 46 |
| 5-30 | 60 | 50 |

* Decreases with the logarithm of the frequency.

TEST RESULTS

Power supply:

AC 240V/60Hz

Polarization

L

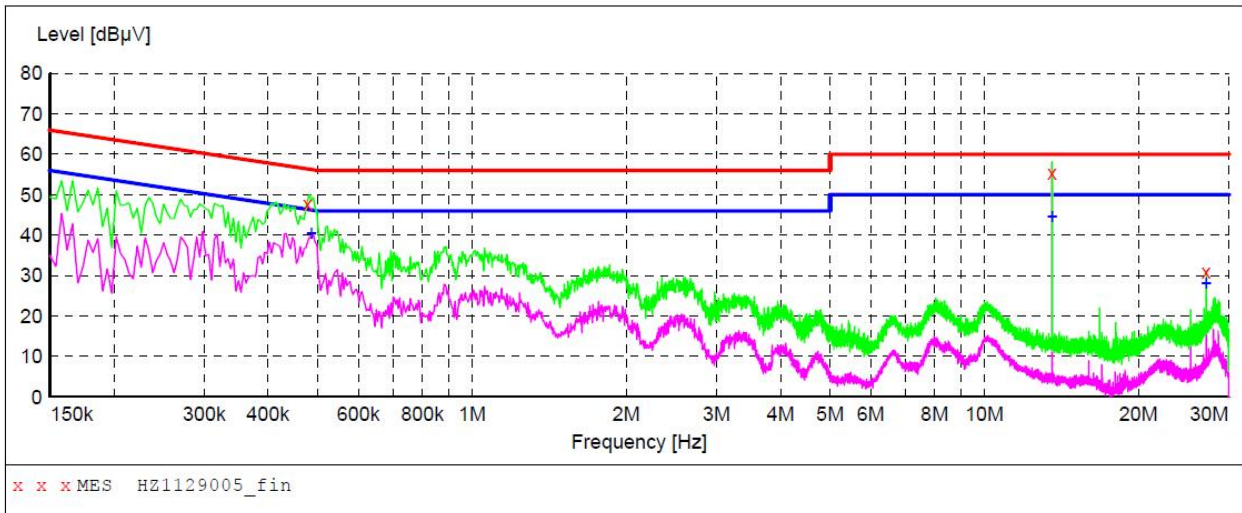

MEASUREMENT RESULT: "HZ1129005_fin"

11/29/2023 9:36APM

| Frequency MHz | Level dBµV | Transd dB | Limit dBµV | Margin dB | Detector | Line | PE |
|------------------|---------------|--------------|---------------|--------------|----------|------|-----|
| 0.478000 | 47.80 | 9.7 | 56 | 8.2 | QP | L1 | GND |
| 13.562000 | 55.40 | 10.0 | 60 | 4.6 | QP | L1 | GND |
| 27.122000 | 30.90 | 10.2 | 60 | 29.1 | QP | L1 | GND |

MEASUREMENT RESULT: "HZ1129005_fin2"

11/29/2023 9:36AM

| Frequency MHz | Level dBµV | Transd dB | Limit dBµV | Margin dB | Detector | Line | PE |
|------------------|---------------|--------------|---------------|--------------|----------|------|-----|
| 0.486000 | 40.50 | 9.7 | 46 | 5.5 | AV | L1 | GND |
| 13.562000 | 44.70 | 10.0 | 50 | 5.3 | AV | L1 | GND |
| 27.122000 | 28.20 | 10.2 | 50 | 21.8 | AV | L1 | GND |

Note:1).Level (dBµV)= Reading (dBµV)+ Transducer (dB)

2). Transducer (dB)=insertion loss of LISN (dB) + Cable loss (dB)

3). Margin(dB) = Limit (dBµV) - Level (dBµV)

Power supply:

AC 240V/60Hz

Polarization

N

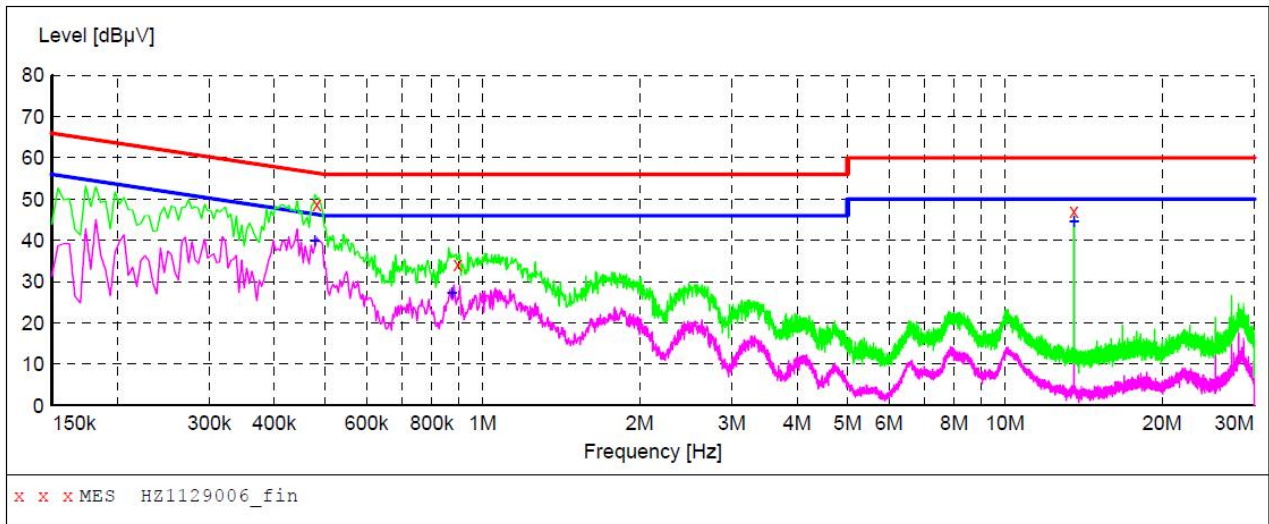

MEASUREMENT RESULT: "HZ1129006_fin"

11/29/2023 9:38AM

| Frequency MHz | Level dBµV | Transd dB | Limit dBµV | Margin dB | Detector | Line | PE |
|------------------|---------------|--------------|---------------|--------------|----------|------|-----|
| 0.482000 | 48.80 | 9.7 | 56 | 7.2 | QP | N | GND |
| 0.898000 | 34.30 | 9.7 | 56 | 21.7 | QP | N | GND |
| 13.562000 | 47.20 | 10.0 | 60 | 12.8 | QP | N | GND |

MEASUREMENT RESULT: "HZ1129006_fin2"

11/29/2023 9:38AM

| Frequency MHz | Level dBµV | Transd dB | Limit dBµV | Margin dB | Detector | Line | PE |
|------------------|---------------|--------------|---------------|--------------|----------|------|-----|
| 0.478000 | 40.10 | 9.7 | 46 | 5.9 | AV | N | GND |
| 0.874000 | 27.30 | 9.7 | 46 | 18.7 | AV | N | GND |
| 13.562000 | 44.60 | 10.0 | 50 | 5.4 | AV | N | GND |

Note:1).Level (dBµV)= Reading (dBµV)+ Transducer (dB)

2). Transducer (dB)=insertion loss of LISN (dB) + Cable loss (dB)

3). Margin(dB) = Limit (dBµV) - Level (dBµV)

4.2 Radiated Emission

LIMIT

- a The field strength of any emissions within the band 13.553–13.567 MHz shall not exceed 15,848 microvolts/ meter at 30 meters.
- b Within the bands 13.410–13.553 MHz and 13.567–13.710 MHz, the field strength of any emissions shall not exceed 334 microvolts/meter at 30 meters.
- c Within the bands 13.110–13.410 MHz and 13.710–14.010 MHz the field strength of any emissions shall not exceed 106 microvolts/meter at 30 meters.
- d The field strength of any emissions appearing outside of the 13.110– 14.010 MHz band shall not exceed the general radiated emission limits in §15.209.

| Frequency (MHz) | Distance (Meters) | Radiated (dBuV/m) | Radiated (µV/m) |
|-----------------|-------------------|---|-----------------------|
| 0.009-0.49 | 3 | $20\log(2400/F(\text{KHz}))+40\log(300/3)$ | $2400/F(\text{KHz})$ |
| 0.49-1.705 | 3 | $20\log(24000/F(\text{KHz}))+ 40\log(30/3)$ | $24000/F(\text{KHz})$ |
| 1.705-13.110 | 3 | 69.54 | 30 |
| 13.110-13.410 | 3 | 80.50 | 106 |
| 13410-13.553 | 3 | 90.47 | 334 |
| 13.553-13.567 | 3 | 124.00 | 15848 |
| 13.567-13.710 | 3 | 90.47 | 334 |
| 13.710-14.010 | 3 | 80.50 | 106 |
| 14.010-30.0 | 3 | 69.54 | 30 |
| 30-88 | 3 | 40.0 | 100 |
| 88-216 | 3 | 43.5 | 150 |
| 216-960 | 3 | 46.0 | 200 |
| Above 960 | 3 | 54.0 | 500 |

TEST CONFIGURATION

Frequency range 9 KHz – 30MHz

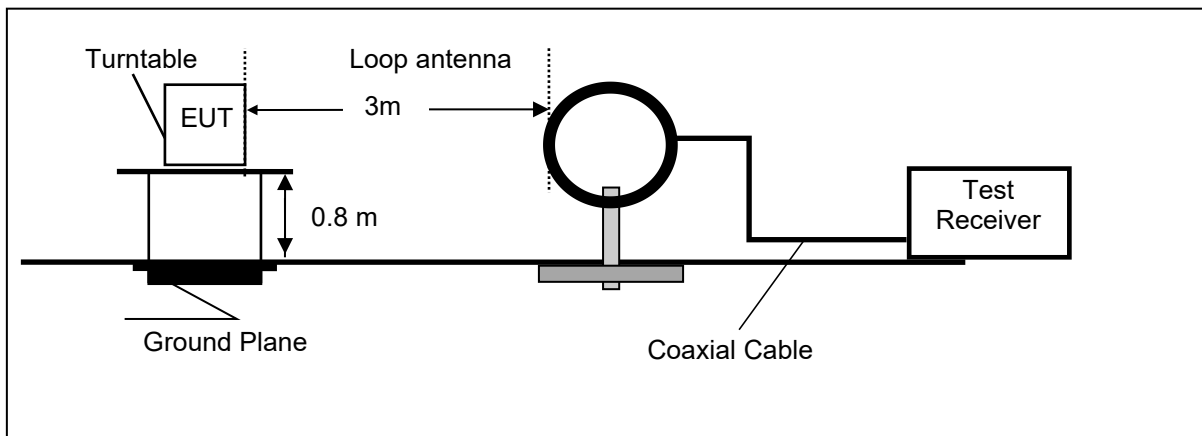

Frequency range 30MHz – 1000MHz

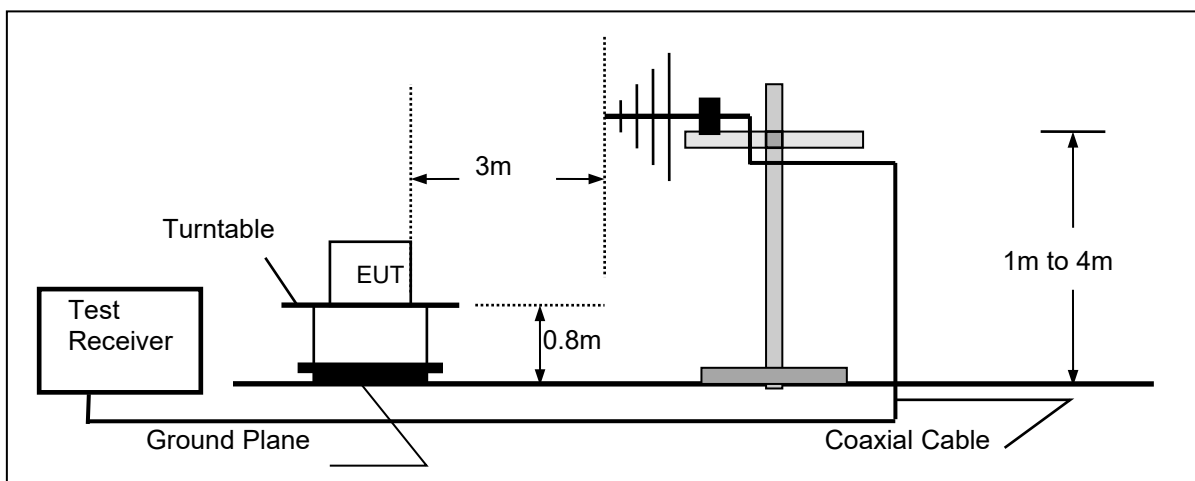

TEST PROCEDURE

1. The EUT was placed on a turn table which is 0.8m above ground plane when testing frequency range 9 KHz –1GHz.
2. Maximum procedure was performed by raising the receiving antenna from 1m to 4m and rotating the turn table from 0° to 360° to acquire the highest emissions from EUT.
3. And also, each emission was to be maximized by changing the polarization of receiving antenna both horizontal and vertical.
4. Repeat above procedures until all frequency measurements have been completed.
5. Radiated emission test frequency band from 9KHz to 1GHz.
6. The distance between test antenna and EUT as following table states:

| Test Frequency range | Test Antenna Type | Test Distance |
|----------------------|-------------------------|---------------|
| 9KHz-30MHz | Active Loop Antenna | 3 |
| 30MHz-1GHz | Ultra-Broadband Antenna | 3 |

7. Setting test receiver/spectrum as following table states:

| Test Frequency range | Test Receiver/Spectrum Setting | Detector |
|----------------------|--|----------|
| 9KHz-150KHz | RBW=200Hz/VBW=3KHz,Sweep time=Auto | QP |
| 150KHz-30MHz | RBW=9KHz/VBW=100KHz,Sweep time=Auto | QP |
| 30MHz-1GHz | RBW=120KHz/VBW=1000KHz,Sweep time=Auto | QP |

Field Strength Calculation

The field strength is calculated by adding the Antenna Factor and Cable Factor and subtracting the Amplifier Gain and Duty Cycle Correction Factor(if any) from the measured reading. The basic equation with a sample calculation is as follows:

$$FS = RA + AF + CL - AG$$

| | |
|---------------------------|--|
| Where FS = Field Strength | CL = Cable Attenuation Factor (Cable Loss) |
| RA = Reading Amplitude | AG = Amplifier Gain |
| AF = Antenna Factor | |

$$Transd=AF +CL-AG$$

RADIATION LIMIT

For intentional device, according to § 15.209(a), the general requirement of field strength of radiated emission from intentional radiators at a distance of 3 meters shall not exceed the following table. According to § 15.247(d), in any 100kHz bandwidth outside the frequency band in which the EUT is operating, the radio frequency power that is produced by the intentional radiator shall be at least 20dB below that in the100kHz bandwidth within the band that contains the highest level of desired power.

The pre-test have done for the EUT in three axes and found the worst emission at position shown in test setup photos.

TEST RESULTS

Remark:

1. This test was performed with EUT in X, Y, Z position and the worse case was found when EUT in X position.
2. Radiated emission test from 9 KHz to 10th harmonic of fundamental was verified, and no emission found except system noise floor in 9 KHz to 30MHz and not recorded in this report.

For 30MHz-1GHz

Horizontal

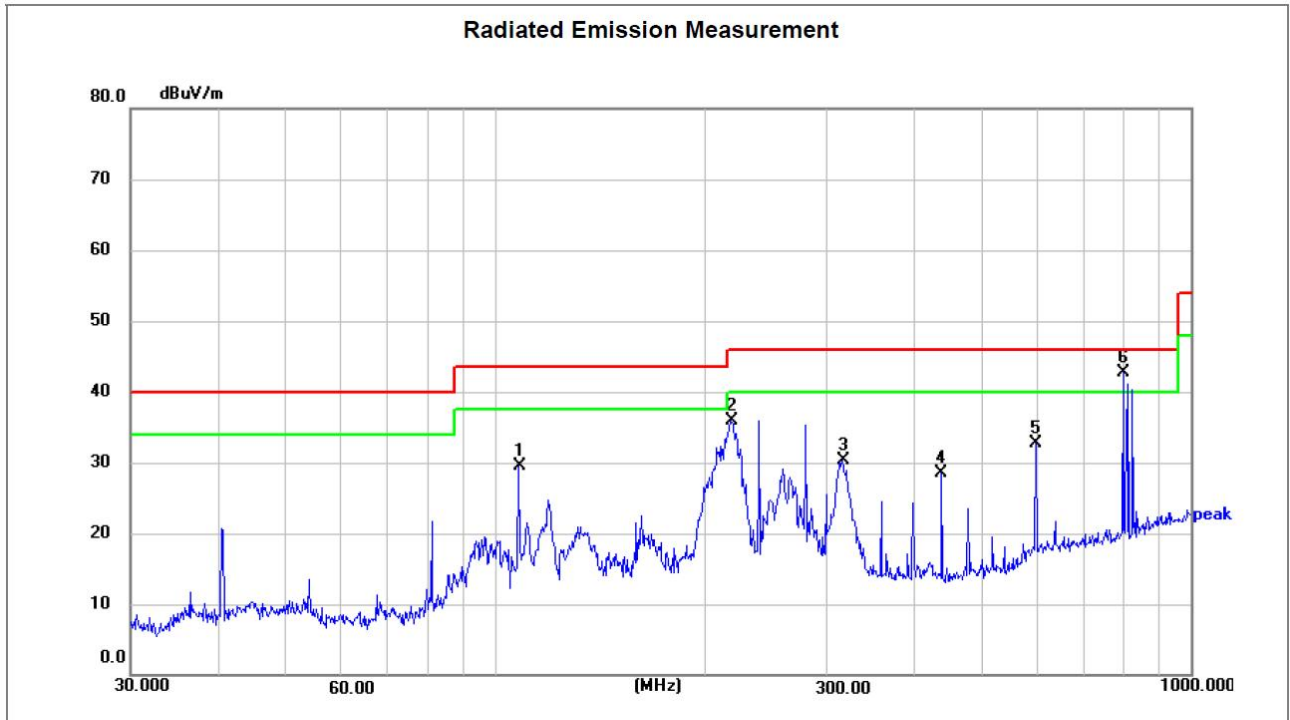

Site LAB
 Limit: FCC Part15 RE-Class B_30-1000MHz
 EUT:
 M/N:
 Mode:
 Note:

Polarization: **Horizontal**
 Power: AC240V/60Hz
 Distance: 3m

Temperature: 24.5(C)
 Humidity: 52 %

| No. | Frequency (MHz) | Reading (dBuV) | Factor (dB/m) | Level (dBuV/m) | Limit (dBuV/m) | Margin (dB) | Detector | Height (cm) | Azimuth (deg.) | P/F | Remark |
|-----|-----------------|----------------|---------------|----------------|----------------|-------------|----------|-------------|----------------|-----|--------|
| 1 | 108.2667 | 48.91 | -19.35 | 29.56 | 43.50 | -13.94 | peak | 199 | 290 | P | |
| 2 | 218.3085 | 54.69 | -18.75 | 35.94 | 46.00 | -10.06 | peak | 100 | 245 | P | |
| 3 | 315.4808 | 47.19 | -16.84 | 30.35 | 46.00 | -15.65 | peak | 100 | 79 | P | |
| 4 | 438.6554 | 43.85 | -15.29 | 28.56 | 46.00 | -17.44 | peak | 100 | 351 | P | |
| 5 | 599.3212 | 43.86 | -11.14 | 32.72 | 46.00 | -13.28 | peak | 199 | 8 | P | |
| 6 * | 798.9797 | 52.38 | -9.69 | 42.69 | 46.00 | -3.31 | peak | 199 | 8 | P | |

- Note:1).Level (dBuV/m)= Reading (dBuV)+ Factor (dB/m)
 2). Factor(dB/m)=Antenna Factor (dB/m) + Cable loss (dB) - Pre Amplifier gain (dB)
 3). Margin(dB) = Level (dBuV/m) - Limit (dBuV/m)

Vertical

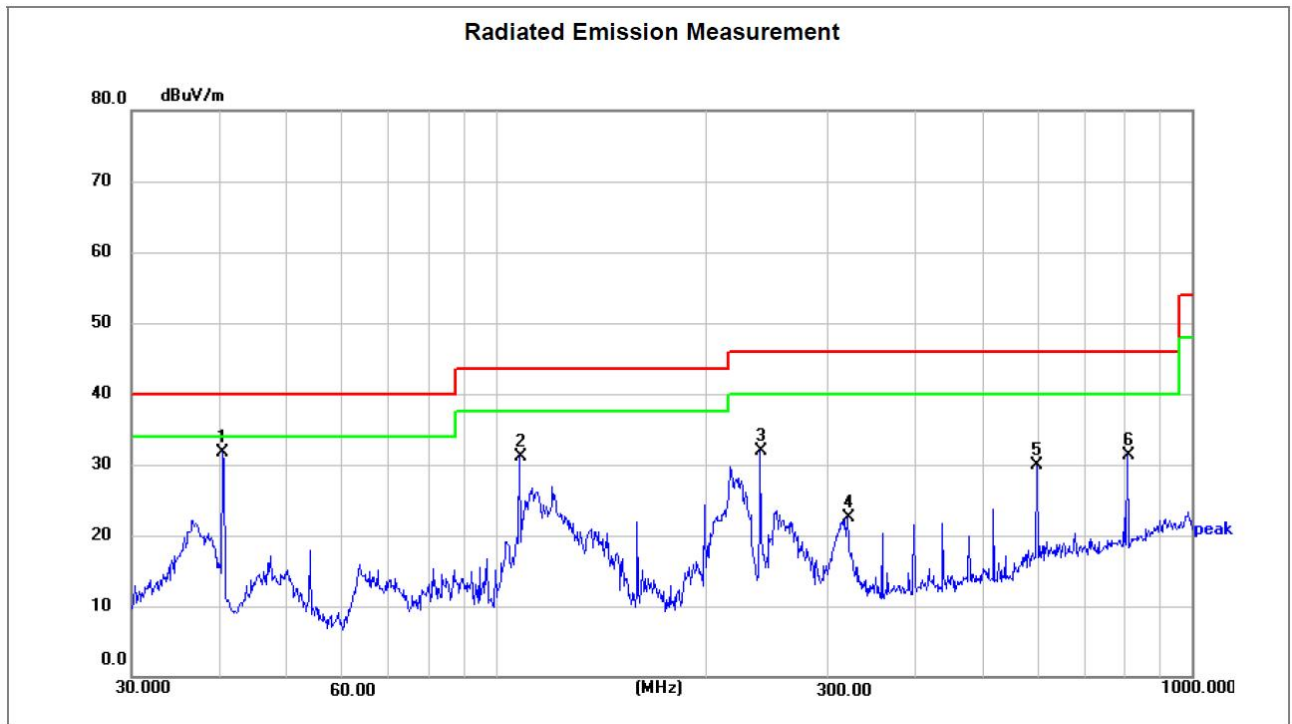

| | | |
|---|---|--|
| Site LAB Limit: FCC Part15 RE-Class B_30-1000MHz EUT: M/N: Mode: Note: | Polarization: Vertical Power: AC240V/60Hz Distance: 3m | Temperature: 24.5(C) Humidity: 52 % |
|---|---|--|

| No. | Frequency (MHz) | Reading (dBuV) | Factor (dB/m) | Level (dBuV/m) | Limit (dBuV/m) | Margin (dB) | Detector | Height (cm) | Azimuth (deg.) | P/F | Remark |
|-----|-----------------|----------------|---------------|----------------|----------------|-------------|----------|-------------|----------------|-----|--------|
| 1 * | 40.5591 | 49.47 | -17.85 | 31.62 | 40.00 | -8.38 | peak | 100 | 360 | P | |
| 2 | 108.2667 | 50.49 | -19.35 | 31.14 | 43.50 | -12.36 | peak | 100 | 360 | P | |
| 3 | 239.9874 | 50.28 | -18.44 | 31.84 | 46.00 | -14.16 | peak | 100 | 160 | P | |
| 4 | 319.9370 | 39.29 | -16.81 | 22.48 | 46.00 | -23.52 | peak | 100 | 248 | P | |
| 5 | 599.3212 | 41.06 | -11.14 | 29.92 | 46.00 | -16.08 | peak | 100 | 90 | P | |
| 6 | 807.4291 | 40.78 | -9.57 | 31.21 | 46.00 | -14.79 | peak | 100 | 195 | P | |

- Note:1).Level (dBuV/m)= Reading (dBuV)+ Factor (dB/m)
 2). Factor(dB/m)=Antenna Factor (dB/m) + Cable loss (dB) - Pre Amplifier gain (dB)
 3). Margin(dB) = Level (dBuV/m) - Limit (dBuV/m)

In-band Emissions and Out-of-band Emissions below 30MHz

| Frequency(MHz) | | | | | | 13.56 | | | |
|----------------|-----------------|-------------------------|----------|----------------|-------------|------------------|-----------------------|-------------------|--------------------------|
| No. | Frequency (MHz) | Emission Level (dBuV/m) | Detector | Limit (dBuV/m) | Margin (dB) | Raw Value (dBuV) | Antenna Factor (dB/m) | Cable Factor (dB) | Correction Factor (dB/m) |
| 1 | 13.15 | 42.65 | PK | 80.5 | 37.85 | 22.63 | 20.37 | -0.35 | 20.02 |
| 2 | 13.55 | 44.73 | PK | 90.47 | 45.74 | 24.67 | 20.42 | -0.36 | 20.06 |
| 3 | 13.56 | 67.82 | PK | 124 | 56.18 | 47.76 | 20.42 | -0.36 | 20.06 |
| 4 | 13.57 | 45.24 | PK | 90.47 | 45.23 | 25.18 | 20.42 | -0.36 | 20.06 |
| 5 | 13.75 | 43.51 | PK | 80.5 | 36.99 | 23.45 | 20.44 | -0.38 | 20.06 |
| 6 | 27.12 | 41.28 | PK | 69.54 | 28.26 | 21.20 | 20.48 | -0.40 | 20.08 |

REMARKS:

1. Emission level (dBuV/m) =Raw Value (dBuV)+Correction Factor (dB/m)
2. Correction Factor (dB/m) = Antenna Factor (dB/m)+Cable Factor (dB)
3. Margin value = Limit value- Emission level.
4. The other emission levels were very low against the limit.

4.3 20dB Bandwidth

Limit

No limit for 20dB bandwidth.

Test Procedure

The 20dB bandwidth is measured with a spectrum analyzer connected via a receive antenna placed near the EUT while the EUT is operating in transmission mode.

The 20dB bandwidth is defined as the total spectrum the power of which is higher than peak power minus 20dB.

Test Configuration

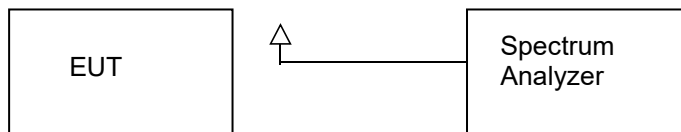

Test Results

| Modulation | Frequency(MHz) | 20dB bandwidth (KHz) | Result |
|------------|----------------|----------------------|--------|
| ASK | 13.56MHz | 4.646 | Pass |

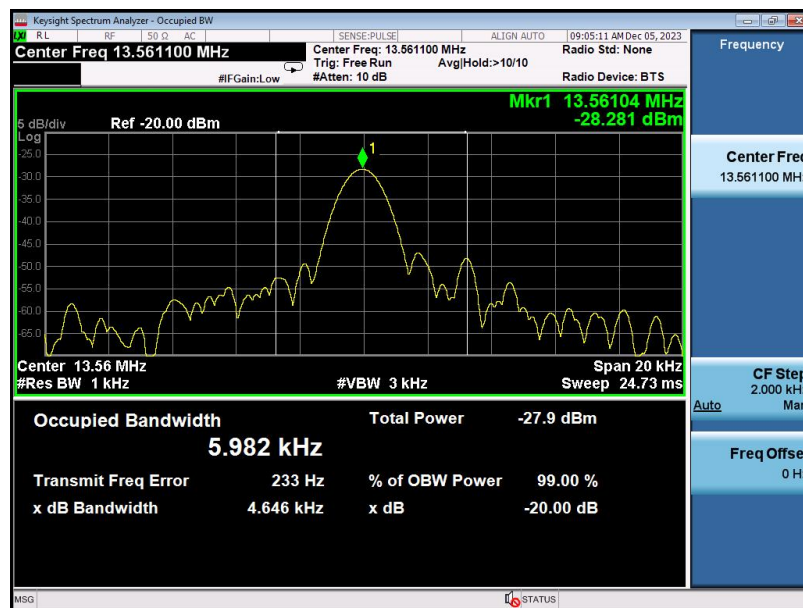

4.4 Frequency Stability

LIMIT

The frequency tolerance of the carrier signal shall be maintained within $\pm 0.01\%$ of the operating frequency over a temperature variation of -20 degrees to $+50$ degrees C at normal supply voltage, and for a variation in the primary supply voltage from 85% to 115% of the rated supply voltage at a temperature of 20 degrees C.

TEST CONFIGURATION

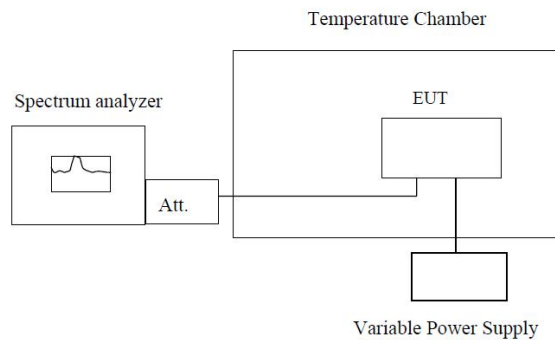

Note : Measurement setup for testing on Antenna connector

TEST PROCEDURE

1. The equipment under test was connected to an external DC power supply and input rated voltage.
2. RF output was connected to a frequency counter or spectrum analyzer via feed through attenuators.
3. The EUT was placed inside the temperature chamber.
4. Set the spectrum analyzer RBW low enough to obtain the desired frequency resolution and measure EUT 20°C operating frequency as reference frequency.
5. Turn EUT off and set the chamber temperature to -20°C . After the temperature stabilized for approximately 30 minutes recorded the frequency.
6. Repeat step measure with 10°C increased per stage until the highest temperature of $+50^{\circ}\text{C}$ reached.
7. Reduce the input voltage to specified extreme voltage variation ($\pm 15\%$) or endpoint, record the maximum frequency change.

TEST RESULTS

| Reference Frequency: 13.56MHz | | | | |
|-------------------------------|------------------|-----------------|-------------------------|---------------|
| Voltage (V) | Temperature (°C) | Frequency (MHz) | Frequency Deviation(Hz) | Deviation (%) |
| 240V | +20(Ref) | 13.560194 | 194 | 0.00001431 |
| | -20 | 13.560152 | 152 | 0.00001121 |
| | -10 | 13.560176 | 176 | 0.00001298 |
| | 0 | 13.560135 | 135 | 0.00000996 |
| | 10 | 13.560184 | 184 | 0.00001357 |
| | 20 | 13.560127 | 127 | 0.00000937 |
| | 25 | 13.560163 | 163 | 0.00001202 |
| | 30 | 13.560142 | 142 | 0.00001047 |
| | 40 | 13.560177 | 177 | 0.00001305 |
| | 50 | 13.560168 | 168 | 0.00001239 |
| 264V | 20 | 13.560143 | 143 | 0.00001055 |
| 216V | 20 | 13.560137 | 137 | 0.00001010 |

5 Test Setup Photos of the EUT

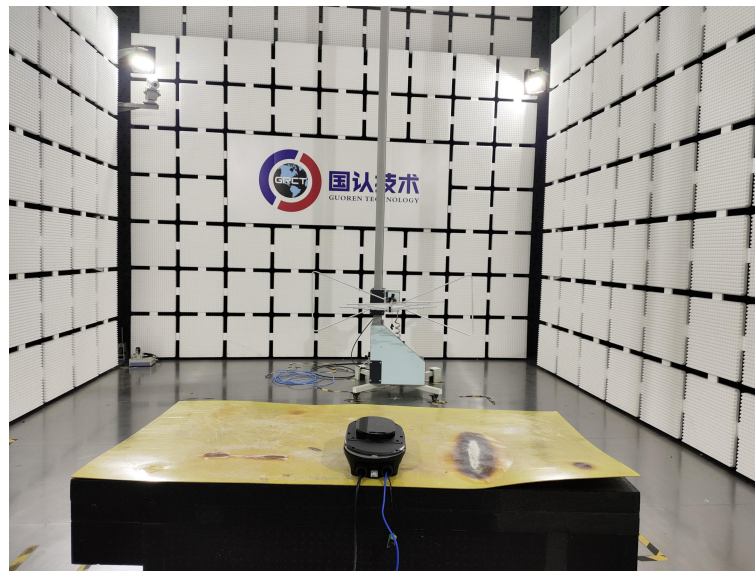
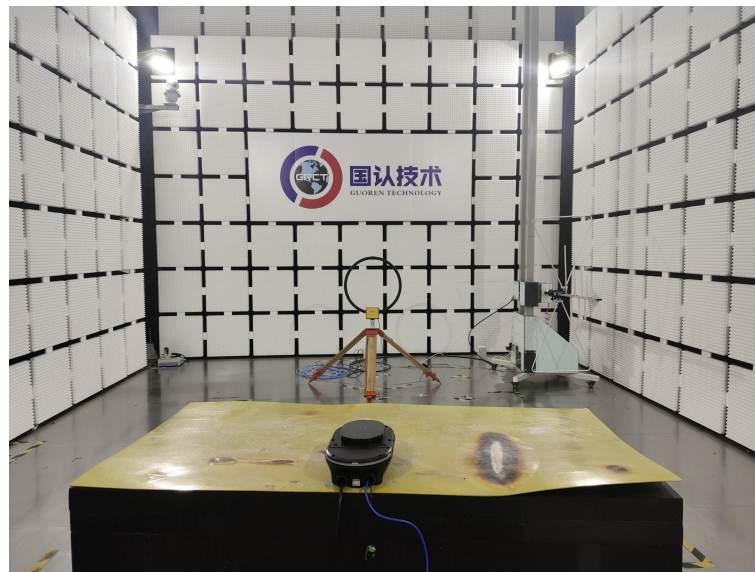

6 Photos of the EUT

Reference to the test report No. GRCTR231002015-01.

******* End of Report *******