



CTC Laboratories, Inc.

1-2/F., Building 2, Jiaquan Building, Guanlan High-Tech Park, Shenzhen, Guangdong, China
Tel: +86-755- 27521059 Fax: +86-755- 27521011 Http://www.sz-ctc.org.cn

TEST REPORT

Report No.: **CTC20231598E05**

FCC ID.....: **2A2C7-MC07A**

IC.....: **27313-MC07A**

Applicant.....: **Clear Touch Solutions, Inc.**

Address.....: 1100 Thousand Oaks Blvd. Greenville, SC 29607, United States

Manufacturer.....: Clear Touch Solutions, Inc.

Address.....: 1100 Thousand Oaks Blvd. Greenville, SC 29607, United States

Product Name.....: **CM100 Microphone Kit**

Trade Mark.....: Clear Touch

Model/Type reference.....: CTS-CM100-245G

Listed Model(s): /



Standard.....: **FCC CFR Title 47 Part 15 Subpart C Section 15.247**

Date of receipt of test sample...: Jul. 24, 2023

Date of testing.....: Jul. 25, 2023 ~ Aug. 18, 2023

Date of issue.....: Aug. 19, 2023

Result.....: **PASS**

Compiled by:		
(Printed name+signature)	Terry Su	
Supervised by:		
(Printed name+signature)	Eric Zhang	
Approved by:		
(Printed name+signature)	Totti Zhao	

Testing Laboratory Name.....: **CTC Laboratories, Inc.**

Address.....: 1-2/F., Building 2, Jiaquan Building, Guanlan High-Tech Park, Shenzhen, Guangdong, China

This test report may be duplicated completely for legal use with the approval of the applicant. It should not be reproduced except in full, without the written approval of our laboratory. The client should not use it to claim product endorsement by CTC. The test results in the report only apply to the tested sample. The test report shall be invalid without all the signatures of testing engineers, reviewer and approver. Any objections must be raised to CTC within 15 days since the date when the report is received. It will not be taken into consideration beyond this limit. The test report merely correspond to the test sample.



Table of Contents

Page

1. TEST SUMMARY..... 3

1.1. TEST STANDARDS3

1.2. REPORT VERSION3

1.3. TEST DESCRIPTION4

1.4. TEST FACILITY5

1.5. MEASUREMENT UNCERTAINTY5

1.6. ENVIRONMENTAL CONDITIONS6

2. GENERAL INFORMATION..... 7

2.1. CLIENT INFORMATION7

2.2. GENERAL DESCRIPTION OF EUT7

2.3. ACCESSORY EQUIPMENT INFORMATION.....8

2.4. OPERATION STATE9

2.5. MEASUREMENT INSTRUMENTS LIST11

3. TEST ITEM AND RESULTS13

3.1. CONDUCTED EMISSION13

3.2. RADIATED EMISSION.....16

3.3. BAND EDGE EMISSIONS (RADIATED).....56

3.4. BAND EDGE AND SPURIOUS EMISSIONS (CONDUCTED)81

3.5. DTS BANDWIDTH107

3.6. MAXIMUM CONDUCTED OUTPUT POWER.....121

3.7. POWER SPECTRAL DENSITY.....123

3.8. DUTY CYCLE.....131

3.9. ANTENNA REQUIREMENT139



1. TEST SUMMARY

1.1. Test Standards

The tests were performed according to following standards:

[FCC Rules Part 15.247](#): Operation within the bands of 902-928MHz, 2400-2483.5MHz, and 5725-5850MHz.

[RSS 247 Issue 2](#): Standard Specifications for Frequency Hopping Systems (FHSs) and Digital Transmission Systems (DTSS) Operating in the Bands 902-928MHz, 2400-2483.5MHz and 5725-5850MHz.

[ANSI C63.10-2013](#): American National Standard for Testing Unlicensed Wireless Devices.

1.2. Report version

Revised No.	Date of issue	Description
01	Aug. 19, 2023	Original



1.3. Test Description

FCC Part 15 Subpart C (15.247) / RSS 247 Issue 2				
Test Item	Standard Section		Result	Test Engineer
	FCC	IC		
Antenna Requirement	15.203	/	Pass	Alicia Liu
Conducted Emission	15.207	RSS-Gen 8.8	Pass	Curry Ye
Radiated Band Edge and Spurious Emissions	15.205&15.209&15.247(d)	RSS 247 5.5	Pass	Alicia Liu
Conducted Band Edge and Spurious Emissions	15.247(d)	RSS 247 5.5	Pass	Alicia Liu
6dB Bandwidth	15.247(a)(2)	RSS 247 5.2 (a)	Pass	Alicia Liu
Conducted Max Output Power	15.247(b)(3)	RSS 247 5.4 (d)	Pass	Alicia Liu
Power Spectral Density	15.247(e)	RSS 247 5.2 (b)	Pass	Alicia Liu
Transmitter Radiated Spurious	15.209&15.247(d)	RSS 247 5.5&RSS-Gen 8.9	Pass	Alicia Liu

Note: The measurement uncertainty is not included in the test result.



1.4. Test Facility

CTC Laboratories, Inc.

Add: 1-2/F., Building 2, Jiaquan Building, Guanlan High-Tech Park, Shenzhen, Guangdong, China

Laboratory accreditation

The test facility is recognized, certified, or accredited by the following organizations:

A2LA-Lab Cert. No.: 4340.01

CTC Laboratories, Inc. EMC Laboratory has been accredited by A2LA for technical competence in the field of electrical testing, and proved to be in compliance with ISO/IEC 17025:2017 General Requirements for the Competence of Testing and Calibration Laboratories and any additional program requirements in the identified field of testing.

Industry Canada (Registration No.: 9783A, CAB Identifier: CN0029)

CTC Laboratories, Inc. EMC Laboratory has been registered by Certification and Engineer Bureau of Industry Canada for the performance of with Registration NO.: 9783A on Jan, 2016.

FCC (Registration No.: 951311, Designation Number CN1208)

CTC Laboratories, Inc. EMC Laboratory has been registered and fully described in a report filed with the (FCC) Federal Communications Commission. The acceptance letter from the FCC is maintained in our files. Registration 951311, Aug 26, 2017.

1.5. Measurement Uncertainty

The data and results referenced in this document are true and accurate. The reader is cautioned that there may be errors within the calibration limits of the equipment and facilities. The measurement uncertainty was calculated for all measurements listed in this test report acc. to TR-100028-01 "Electromagnetic compatibility and Radio spectrum Matters (ERM); Uncertainties in the measurement of mobile radio equipment characteristics; Part 1" and TR-100028-02 "Electromagnetic compatibility and Radio spectrum Matters (ERM); Uncertainties in the measurement of mobile radio equipment characteristics; Part 2" and is documented in the CTC Laboratories, Inc. quality system acc. to DIN EN ISO/IEC 17025. Furthermore, component and process variability of devices similar to that tested may result in additional deviation. The manufacturer has the sole responsibility of continued compliance of the device.

Below is the best measurement capability for CTC Laboratories, Inc.



Test Items	Measurement Uncertainty	Notes
DTS Bandwidth	±0.0196%	(1)
Maximum Conducted Output Power	±0.686 dB	(1)
Maximum Power Spectral Density Level	±0.743 dB	(1)
Band-edge Compliance	±1.328 dB	(1)
Unwanted Emissions In Non-restricted Freq Bands	9kHz-1GHz: ±0.746dB 1GHz-26GHz: ±1.328dB	(1)
Conducted Emissions 9kHz~30MHz	±3.08 dB	(1)
Radiated Emissions 30~1000MHz	±4.51 dB	(1)
Radiated Emissions 1~18GHz	±5.84 dB	(1)
Radiated Emissions 18~40GHz	±6.12 dB	(1)

Note (1): This uncertainty represents an expanded uncertainty expressed at approximately the 95% confidence level using a coverage factor of k=2.

1.6. Environmental conditions

During the measurement the environmental conditions were within the listed ranges:

Temperature:	21°C ~ 27°C
Relative Humidity:	40% ~ 60%
Air Pressure:	101kPa



2. GENERAL INFORMATION

2.1. Client Information

Applicant:	Clear Touch Solutions, Inc.
Address:	1100 Thousand Oaks Blvd. Greenville, SC 29607, United States
Manufacturer:	Clear Touch Solutions, Inc.
Address:	1100 Thousand Oaks Blvd. Greenville, SC 29607, United States

2.2. General Description of EUT

Product Name:	CM100 Microphone Kit
Trade Mark:	Clear Touch
Model/Type reference:	CTS-CM100-245G
Listed Model(s):	/
Power supply:	5Vdc from USB Cable 3.8Vdc from 350mAh Li-ion Battery
Hardware version:	D23241
Software version:	V0.1.9
WIFI 802.11b/ g/ n(HT20)/ n(HT40)/ ax(HE20)/ ax(HE40)	
Modulation:	802.11b: DSSS (CCK, DQPSK, DBPSK) 802.11g/ n: OFDM (BPSK, QPSK, 16QAM, 64QAM) 802.11ax: OFDMA (BPSK, QPSK, 16QAM, 64QAM, 256QAM, 1024QAM)
Operation frequency:	802.11b/ g/ n(HT20)/ ax(HE20): 2412MHz~2462MHz 802.11n(HT40)/ ax(HE40): 2422MHz~2452MHz
Channel number:	802.11b/ g/ n(HT20)/ ax(HE20): 11channels 802.11n(HT40)/ ax(HE40): 7channels
Channel separation:	5MHz
Antenna type:	PCB Antenna
Antenna gain:	3.32dBi Max



2.3. Accessory Equipment information

Equipment Information			
Name	Model	S/N	Manufacturer
Notebook	ThinkBook 14G3 ACL	MP246QDR	Lenovo
/	/	/	/

Cable Information			
Name	Shielded Type	Ferrite Core	Length
/	/	/	/

Test Software Information			
Name	Versions	/	/
SecureCRTPortable	7.0.0.326	/	/



2.4. Operation state

Operation Frequency List: The EUT has been tested under typical operating condition. The Applicant provides communication tools software to control the EUT for staying in continuous transmitting and receiving mode for testing.

Operation Frequency List:

Channel	Frequency (MHz)
01	2412
02	2417
03	2422
04	2427
05	2432
06	2437
07	2442
08	2447
09	2452
10	2457
11	2462

Note: CH 01~CH 11 for 802.11b/g/n(HT20)/ax(HE20), CH 03~CH 09 for 802.11n(HT40)/ax(HE40).

Data Rated

Preliminary tests were performed in different data rate, and found which the below bit rate is worst case mode, so only show data which it is a worst case mode.

Mode	Data rate (worst mode)
802.11b	1Mbps
802.11g	6Mbps
802.11n(HT20)/ (HT40)	HT-MCS0
802.11ax(HE20)/ (HE40)	HE-MCS0

RU Configuration

Operating Mode	Resource Unit	242 Tone (20M)
802.11ax(HE20)	Specific Resource Unit	61
Operating Mode	Resource Unit	484 Tone (40M)
802.11ax(HE40)	Specific Resource Unit	65



Test mode

For RF test items:
The engineering test program was provided and enabled to make EUT continuous transmit.
For AC power line conducted emissions:
The EUT was set to connect with the WLAN AP under large package sizes transmission.
For Radiated spurious emissions test item:
The engineering test program was provided and enabled to make EUT continuous transmit. The EUT in each of three orthogonal axis emissions had been tested, but only the worst case (X axis) data Recorded in the report.



2.5. Measurement Instruments List

Tonscend JS0806-2 Test system					
Item	Test Equipment	Manufacturer	Model No.	Serial No.	Calibrated until
1	MXA Signal Analyzer	Keysight	N9020A	MY46471737	Dec. 16, 2023
2	Spectrum Analyzer	R&S	FSU26	100105	Dec. 16, 2023
3	Spectrum Analyzer	R&S	FSV40-N	101331	Mar. 14, 2024
4	MXG Vector Signal Generator	Agilent	N5182A	MY47420864	Dec. 16, 2023
5	PSG Analog Signal Generator	Agilent	E8257D	MY46521908	Dec. 16, 2023
6	Power Sensor	Keysight	U2021XA	MY55130004	Mar. 14, 2024
7	Power Sensor	Keysight	U2021XA	MY55130006	Mar. 14, 2024
8	Wideband Radio Communication Tester	R&S	CMW500	102414	Dec. 16, 2023
9	High and low temperature box	ESPEC	MT3035	/	Mar. 24, 2024
10	JS1120 RF Test system	TONSCEND	v2.6	/	/

Radiated emission(3m chamber 2)					
Item	Test Equipment	Manufacturer	Model No.	Serial No.	Calibrated Until
1	Trilog-Broadband Antenna	Schwarzbeck	VULB 9168	9168-1013	Dec. 07, 2024
2	Horn Antenna	Schwarzbeck	BBHA 9120D	9120D-647	Dec. 07, 2024
3	Loop Antenna	LAPLAC	RF300	9138	Dec. 16, 2023
4	Spectrum Analyzer	R&S	FSU26	100105	Dec. 16, 2023
5	Spectrum Analyzer	R&S	FSV40-N	101331	Mar. 14, 2024
6	Pre-Amplifier	SONOMA	310	186194	Dec. 16, 2023
7	Low Noise Pre-Amplifier	EMCI	EMC051835	980075	Dec. 16, 2023
8	Test Receiver	R&S	ESC17	100967	Dec. 16, 2023
9	3m chamber 2	Frankonia	EE025	/	Oct. 23, 2024

Radiated emission(3m chamber 3)					
Item	Test Equipment	Manufacturer	Model No.	Serial No.	Calibrated Until
1	Trilog-Broadband Antenna	Schwarzbeck	VULB 9163	01026	Dec. 18, 2024
2	Horn Antenna	Schwarzbeck	BBHA 9120D	9120D-647	Dec. 01, 2024
3	Test Receiver	Keysight	N9038A	MY56400071	Dec. 16, 2023
4	Broadband Premplifier	SCHWARZBECK	BBV9743B	259	Dec. 16, 2023
5	Mirowave Broadband Amplifier	SCHWARZBECK	BBV9718C	111	Dec. 16, 2023
6	Pre-Amplifier	R&S	SCU-26	10033	Dec. 16, 2023
7	Pre-Amplifier	R&S	SCU-40	10030	Dec. 16, 2023
8	Board-Band Horn Antenna	Schwarzbeck	BBHA 9170	BBHA 9170-497	Dec. 16, 2023
9	3m chamber 3	YIHENG	EE106	/	Sep. 09, 2023

CTC Laboratories, Inc.

1-2/F., Building 2, Jiaquan Building, Guanlan High-Tech Park, Shenzhen, Guangdong, China

Tel.: (86)755-27521059

Fax: (86)755-27521011

Http://www.sz-ctc.org.cn



For anti-fake verification, please visit the official website of Certification and Accreditation Administration of the People's Republic of China : yz.cnca.cn



Conducted Emission					
Item	Test Equipment	Manufacturer	Model No.	Serial No.	Calibrated until
1	LISN	R&S	ENV216	101112	Dec. 16, 2023
2	LISN	R&S	ENV216	101113	Dec. 16, 2023
3	EMI Test Receiver	R&S	ESCS30	100353	Dec. 16, 2023

Note: 1. The Cal. Interval was one year.

2. The Cal. Interval was three year of the chamber

3. The cable loss has calculated in test result which connection between each test instruments.

3. TEST ITEM AND RESULTS

3.1. Conducted Emission

Limit

FCC CFR Title 47 Part 15 Subpart C Section 15.207/ RSS - Gen 8.8:

Frequency range (MHz)	Limit (dBuV)	
	Quasi-peak	Average
0.15-0.5	66 to 56*	56 to 46*
0.5-5	56	46
5-30	60	50

* Decreases with the logarithm of the frequency.

Test Configuration

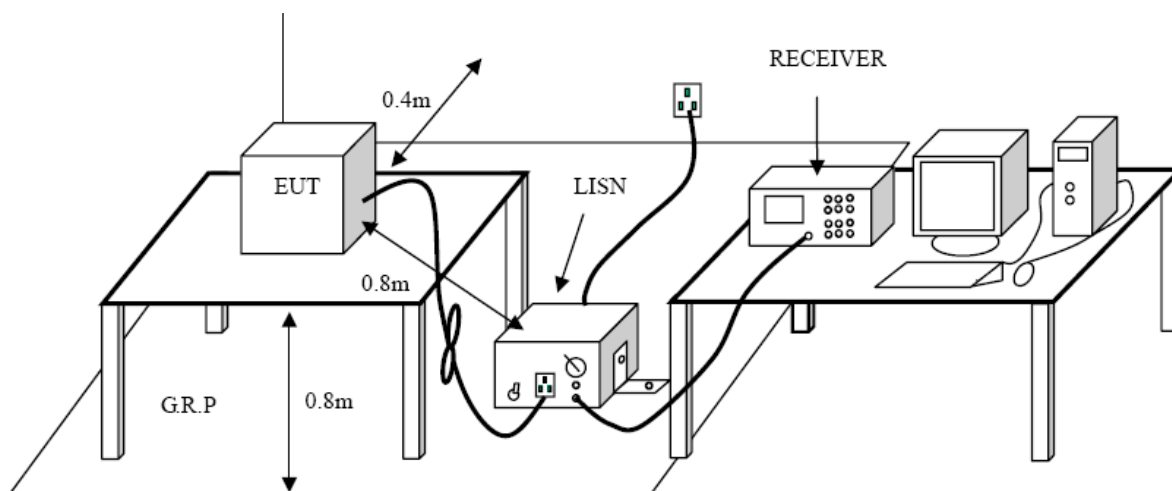

Test Procedure

1. The EUT was setup according to ANSI C63.10:2013 requirements.
2. The EUT was placed on a platform of nominal size, 1 m by 1.5 m, raised 80 cm above the conducting ground plane. The vertical conducting plane was located 40 cm to the rear of the EUT. All other surfaces of EUT were at least 80 cm from any other grounded conducting surface.
3. The EUT and simulators are connected to the main power through a line impedances stabilization network (LISN). The LISN provides a 50ohm /50uH coupling impedance for the measuring equipment. The peripheral devices are also connected to the main power through a LISN. (Please refer to the block diagram of the test setup and photographs)
4. Each current-carrying conductor of the EUT power cord, except the ground (safety) conductor, was individually connected through a LISN to the input power source.
5. The excess length of the power cord between the EUT and the LISN receptacle were folded back and forth at the center of the lead to form a bundle not exceeding 40 cm in length.
6. Conducted Emissions were investigated over the frequency range from 0.15MHz to 30MHz using a receiver bandwidth of 9 kHz.
7. During the above scans, the emissions were maximized by cable manipulation.



Test Mode:

Please refer to the clause 2.4.

Test Results

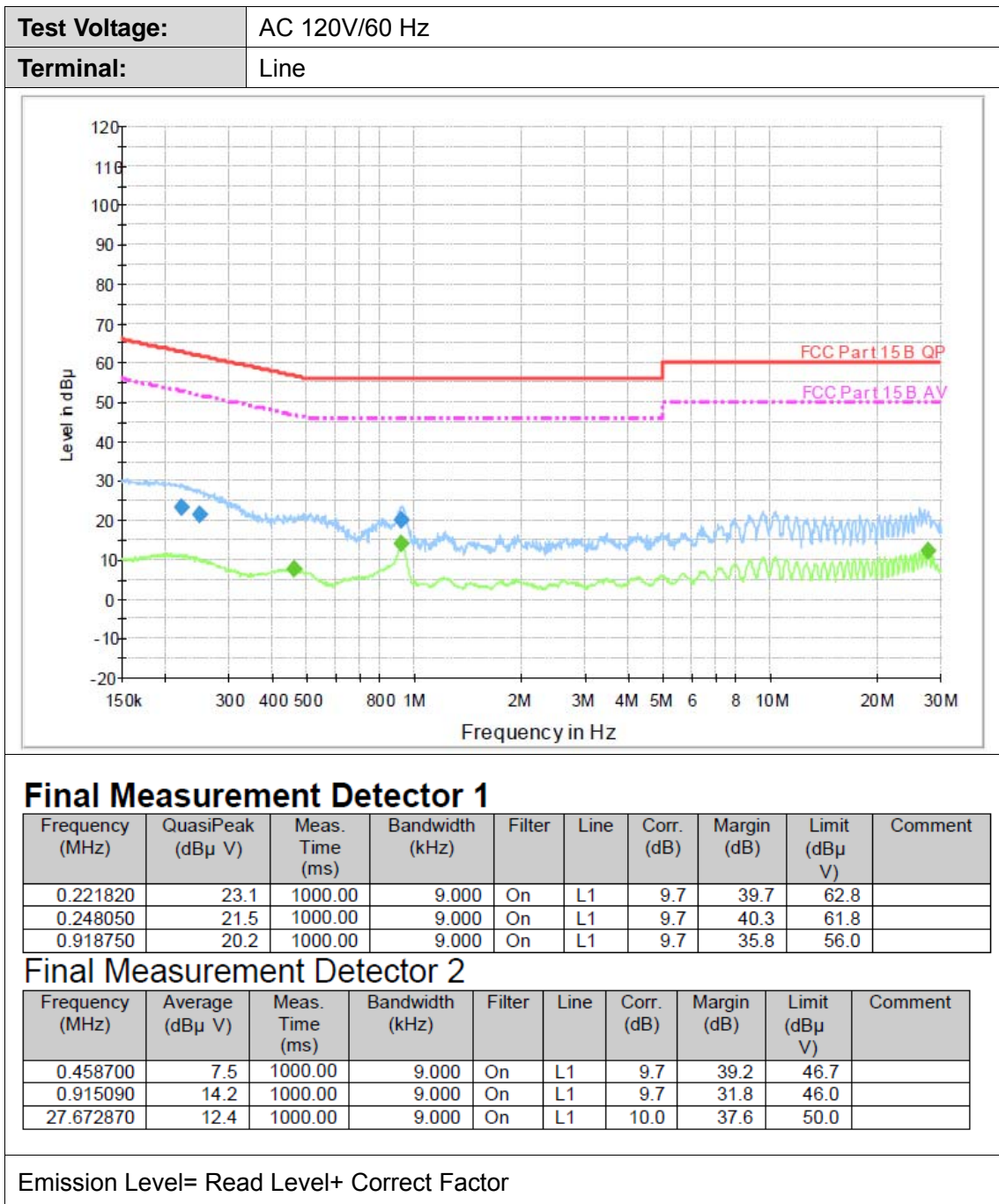



Test Voltage:	AC 120V/60 Hz
Terminal:	Neutral

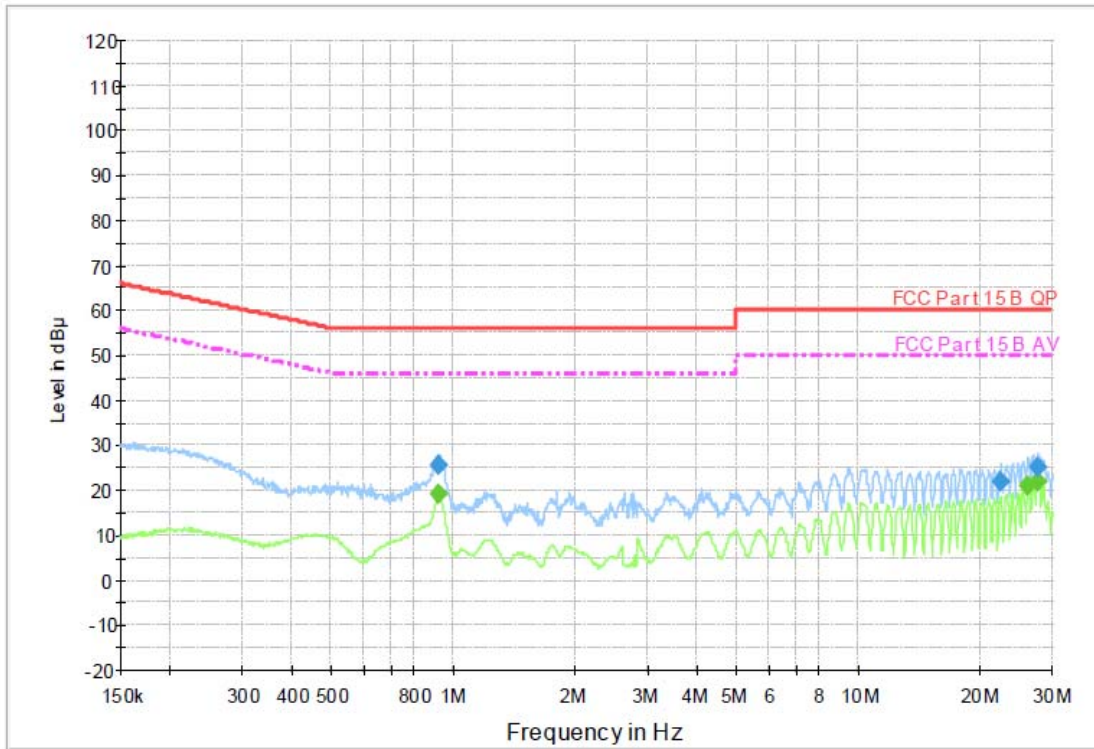

Final Measurement Detector 1

Frequency (MHz)	QuasiPeak (dBµ V)	Meas. Time (ms)	Bandwidth (kHz)	Filter	Line	Corr. (dB)	Margin (dB)	Limit (dBµ V)	Comment
0.915090	25.4	1000.00	9.000	On	N	10.0	30.6	56.0	
22.395840	21.9	1000.00	9.000	On	N	10.0	38.1	60.0	
27.672870	25.2	1000.00	9.000	On	N	10.0	34.8	60.0	

Final Measurement Detector 2

Frequency (MHz)	Average (dBµ V)	Meas. Time (ms)	Bandwidth (kHz)	Filter	Line	Corr. (dB)	Margin (dB)	Limit (dBµ V)	Comment
0.915090	19.3	1000.00	9.000	On	N	10.0	16.7	46.0	
26.168700	21.0	1000.00	9.000	On	N	10.0	29.0	50.0	
27.672870	21.9	1000.00	9.000	On	N	10.0	28.1	50.0	

Emission Level= Read Level+ Correct Factor

3.2. Radiated Emission

Limit

FCC CFR Title 47 Part 15 Subpart C Section 15.209/ RSS – Gen 8.9:

Frequency	Limit (dBuV/m @3m)	Value
30 MHz ~ 88 MHz	40.00	Quasi-peak
88 MHz ~ 216 MHz	43.50	Quasi-peak
216 MHz ~ 960 MHz	46.00	Quasi-peak
960 MHz ~ 1 GHz	54.00	Quasi-peak
Above 1 GHz	54.00	Average
	74.00	Peak

Note:

- (1) The tighter limit applies at the band edges.
- (2) Emission Level (dBuV/m)=20log Emission Level (uV/m).

Test Configuration

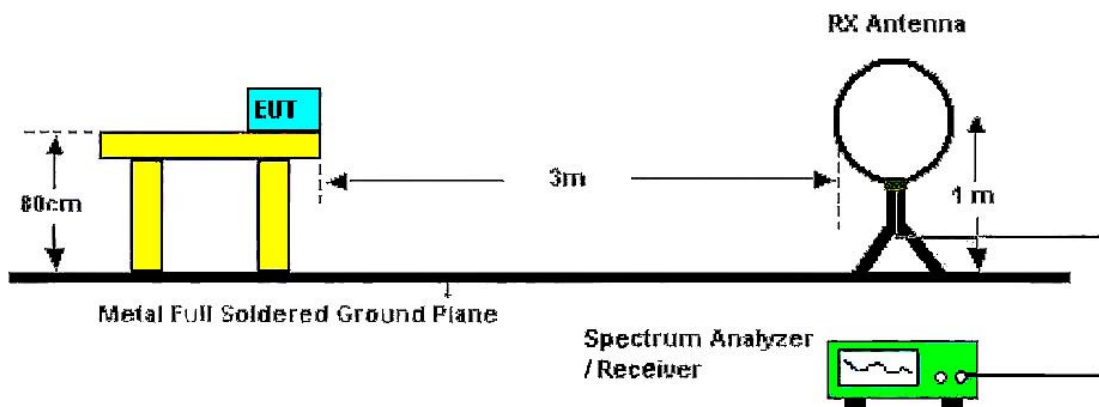

Below 30MHz Test Setup

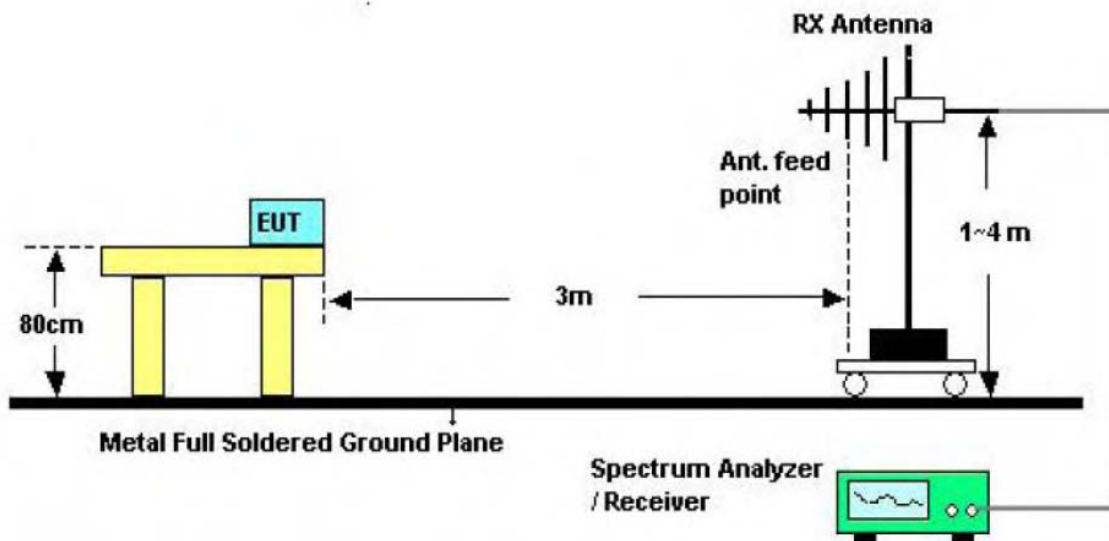

Below 1000MHz Test Setup

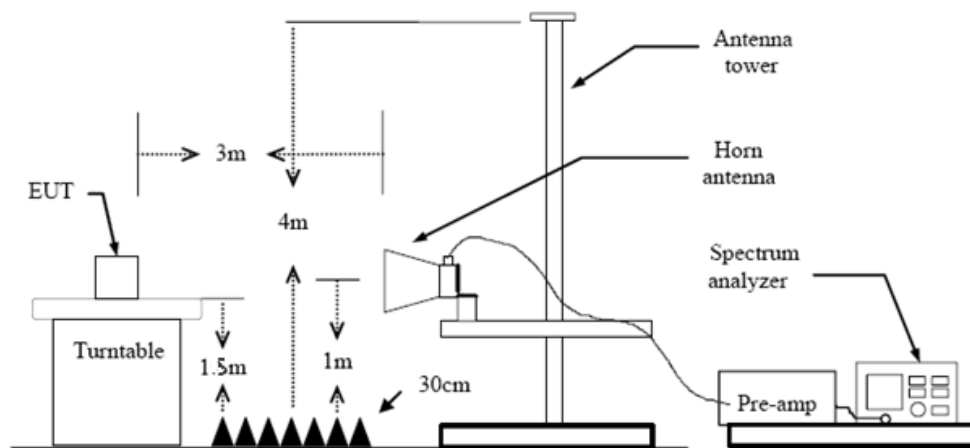

Above 1GHz Test Setup

Test Procedure

1. The EUT was setup and tested according to ANSI C63.10:2013
 2. The EUT is placed on a turn table which is 0.8 meter above ground for below 1 GHz, and 1.5 m for above 1 GHz. The turn table is rotated 360 degrees to determine the position of the maximum emission level.
 3. The EUT was set 3 meters from the receiving antenna, which was mounted on the top of a variable height antenna tower.
 4. For each suspected emission, the EUT was arranged to its worst case and then tune the Antenna tower (from 1 m to 4 m) and turntable (from 0 degree to 360 degrees) to find the maximum reading. A pre-amp and a high pass filter are used for the test in order to get better signal level to comply with the guidelines.
 5. Set to the maximum power setting and enable the EUT transmit continuously.
 6. Use the following spectrum analyzer settings
 - (1) Span shall wide enough to fully capture the emission being measured
 - (2) Below 30 MHz:
9kHz – 150kHz, RBW=200Hz, VBW \geq RBW, Sweep=auto, Detector function=peak, Trace=max hold;
150kHz – 30MHz, RBW=9kHz, VBW \geq RBW, Sweep=auto, Detector function=peak, Trace=max hold; If the emission level of the EUT measured by the peak detector is 3 dB lower than the applicable limit, the peak emission level will be reported. Otherwise, the emission measurement will be repeated using the quasi-peak detector and reported.
 - (3) 30 MHz - 1 GHz:
RBW=120 kHz, VBW=300 kHz, Sweep=auto, Detector function=peak, Trace=max hold;
If the emission level of the EUT measured by the peak detector is 3 dB lower than the applicable limit, the peak emission level will be reported. Otherwise, the emission measurement will be repeated using the quasi-peak detector and reported.
 - (4) From 1 GHz to 10th harmonic:
RBW=1MHz, VBW=3MHz Peak detector for Peak value.
RBW=1MHz, VBW \geq 1/T Peak detector for Average value.
- Note 1: For the 1/T & Duty Cycle please refer to clause 3.8 Duty Cycle.

Test Mode

Please refer to the clause 2.4.

Test Result

9 KHz~30 MHz

From 9 KHz to 30 MHz: Conclusion: PASS

Note: The amplitude of spurious emissions which are attenuated by more than 20dB below the permissible value has no need to be reported.



30MHz-1GHz

Ant. Pol.	Horizontal
Test Mode:	802.11b Mode 2412MHz
Remark:	Only worse case is reported

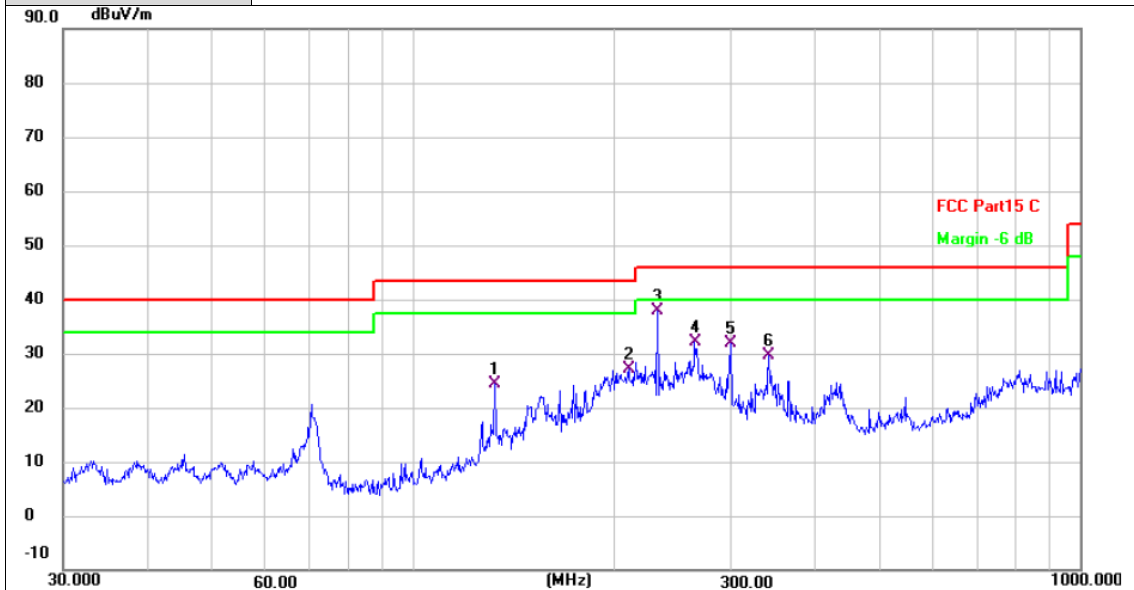

No.	Frequency (MHz)	Reading (dBuV)	Factor (dB/m)	Level (dBuV/m)	Limit (dBuV/m)	Margin (dB)	Detector
1	133.1510	42.72	-18.25	24.47	43.50	-19.03	QP
2	210.7860	47.19	-20.03	27.16	43.50	-16.34	QP
3 *	232.5318	57.23	-19.23	38.00	46.00	-8.00	QP
4	264.7457	50.20	-18.18	32.02	46.00	-13.98	QP
5	300.3672	49.09	-17.16	31.93	46.00	-14.07	QP
6	341.9786	45.83	-16.17	29.66	46.00	-16.34	QP

Remarks:

- Factor (dB/m) = Antenna Factor (dB/m)+Cable Factor (dB)-Pre-amplifier Factor
- Margin value = Level -Limit value



Ant. Pol.	Vertical
Test Mode:	802.11b Mode 2412MHz
Remark:	Only worse case is reported

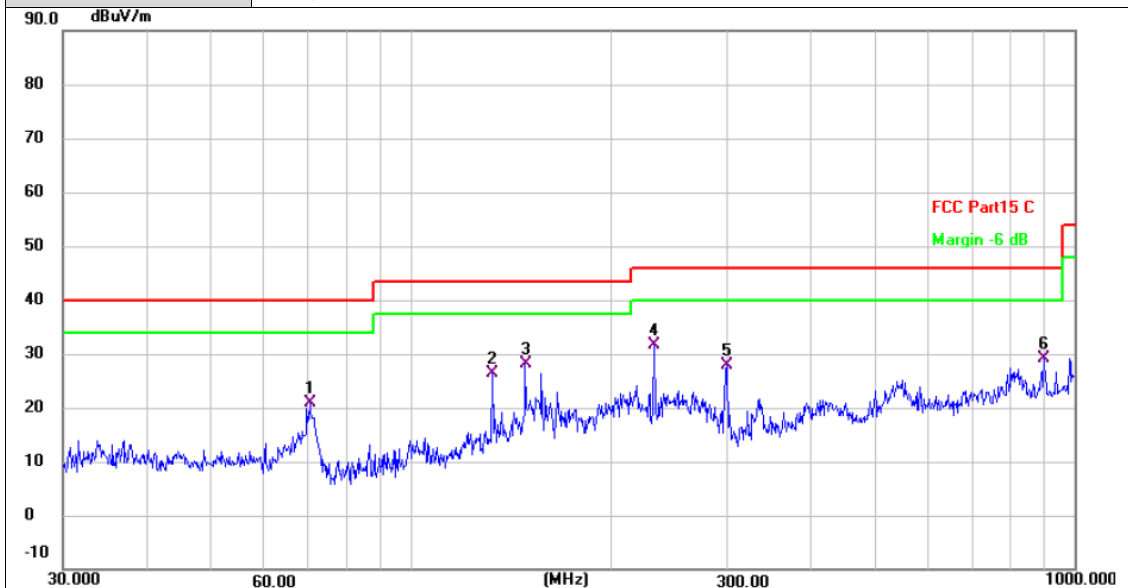

No.	Frequency (MHz)	Reading (dBuV)	Factor (dB/m)	Level (dBuV/m)	Limit (dBuV/m)	Margin (dB)	Detector
1	70.5836	41.52	-20.58	20.94	40.00	-19.06	QP
2	132.6850	44.73	-18.29	26.44	43.50	-17.06	QP
3	148.9625	44.42	-16.38	28.04	43.50	-15.46	QP
4 *	232.5318	50.74	-19.23	31.51	46.00	-14.49	QP
5	299.3158	45.11	-17.19	27.92	46.00	-18.08	QP
6	900.1474	34.96	-5.88	29.08	46.00	-16.92	QP

Remarks:

- 1. Factor (dB/m) = Antenna Factor (dB/m)+Cable Factor (dB)-Pre-amplifier Factor
- 2. Margin value = Level -Limit value



Adobe 1GHz

Ant. Pol.	Horizontal
Test Mode:	TX 802.11b Mode 2412MHz
Remark:	No report for the emission which more than 10 dB below the prescribed limit.

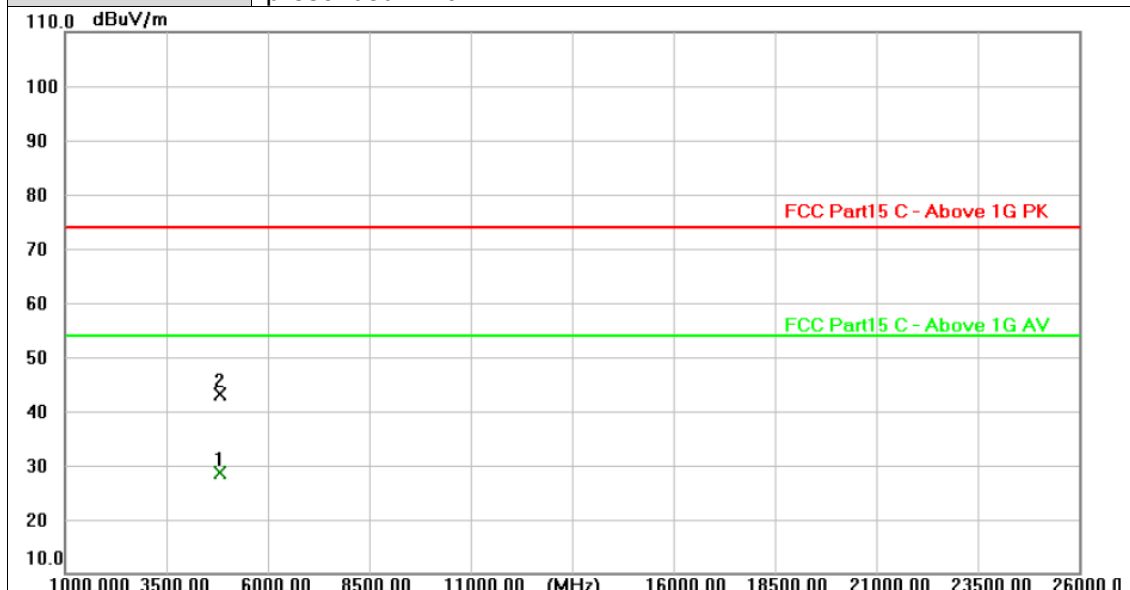

No.	Frequency (MHz)	Reading (dBuV)	Factor (dB/m)	Level (dBuV/m)	Limit (dBuV/m)	Margin (dB)	Detector
1 *	4823.363	26.55	2.20	28.75	54.00	-25.25	AVG
2	4823.629	40.84	2.20	43.04	74.00	-30.96	peak

Remarks:

- 1. Factor (dB/m) = Antenna Factor (dB/m)+Cable Factor (dB)-Pre-amplifier Factor
- 2. Margin value = Level -Limit value



Ant. Pol.	Vertical
Test Mode:	TX 802.11b Mode 2412MHz
Remark:	No report for the emission which more than 10 dB below the prescribed limit.

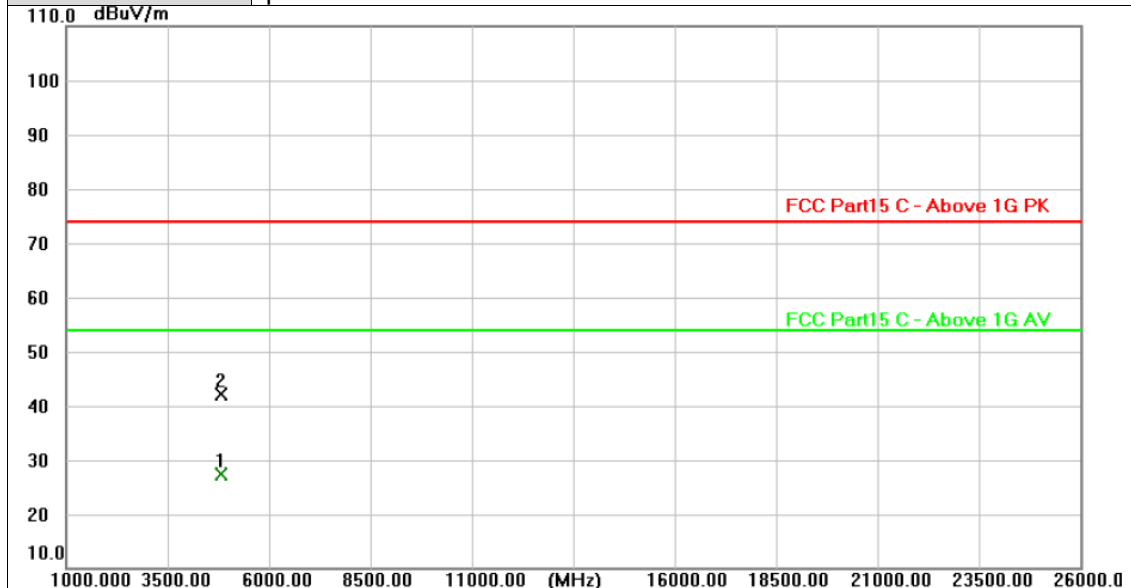

No.	Frequency (MHz)	Reading (dBuV)	Factor (dB/m)	Level (dBuV/m)	Limit (dBuV/m)	Margin (dB)	Detector
1 *	4824.169	25.26	2.20	27.46	54.00	-26.54	AVG
2	4824.251	39.84	2.20	42.04	74.00	-31.96	peak

Remarks:

- 1. Factor (dB/m) = Antenna Factor (dB/m)+Cable Factor (dB)-Pre-amplifier Factor
- 2. Margin value = Level -Limit value



Ant. Pol.	Horizontal
Test Mode:	TX 802.11b Mode 2437MHz
Remark:	No report for the emission which more than 10 dB below the prescribed limit.

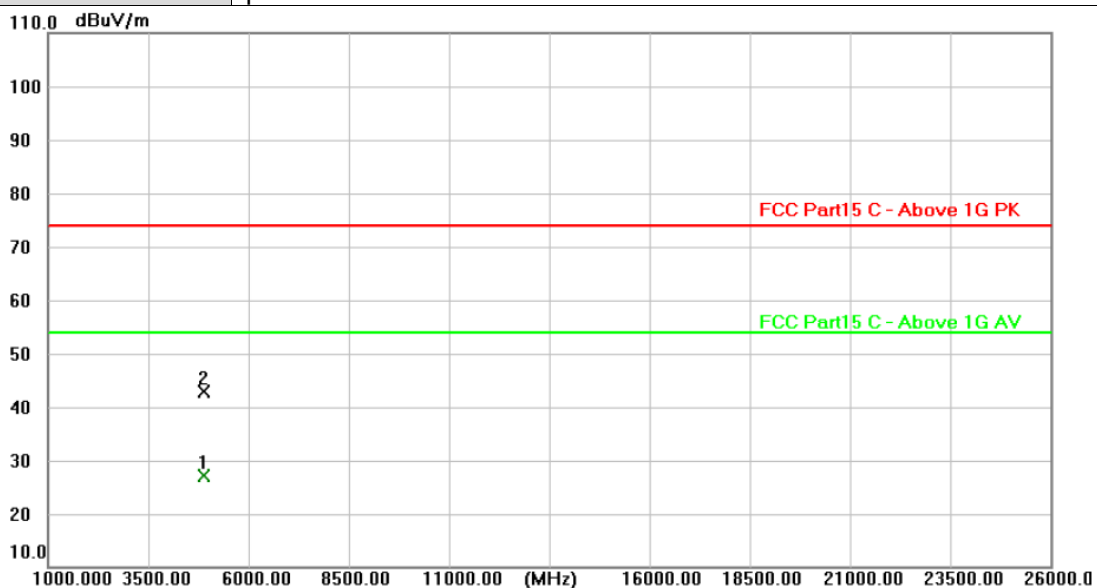

No.	Frequency (MHz)	Reading (dBuV)	Factor (dB/m)	Level (dBuV/m)	Limit (dBuV/m)	Margin (dB)	Detector
1 *	4874.383	24.93	2.30	27.23	54.00	-26.77	AVG
2	4874.921	40.67	2.30	42.97	74.00	-31.03	peak

Remarks:
 1. Factor (dB/m) = Antenna Factor (dB/m)+Cable Factor (dB)-Pre-amplifier Factor
 2. Margin value = Level -Limit value



Ant. Pol.	Vertical
Test Mode:	TX 802.11b Mode 2437MHz
Remark:	No report for the emission which more than 10 dB below the prescribed limit.

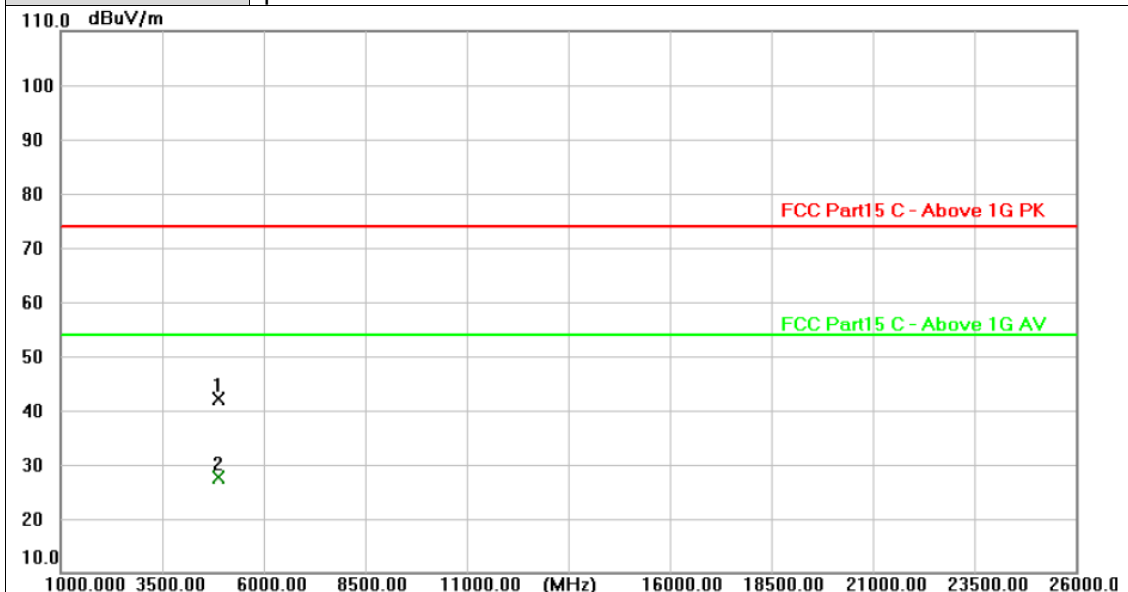

No.	Frequency (MHz)	Reading (dBuV)	Factor (dB/m)	Level (dBuV/m)	Limit (dBuV/m)	Margin (dB)	Detector
1	4874.501	39.82	2.30	42.12	74.00	-31.88	peak
2 *	4874.975	25.42	2.30	27.72	54.00	-26.28	AVG

Remarks:

- 1. Factor (dB/m) = Antenna Factor (dB/m)+Cable Factor (dB)-Pre-amplifier Factor
- 2. Margin value = Level -Limit value



Ant. Pol.	Horizontal
Test Mode:	TX 802.11b Mode 2462MHz
Remark:	No report for the emission which more than 10 dB below the prescribed limit.

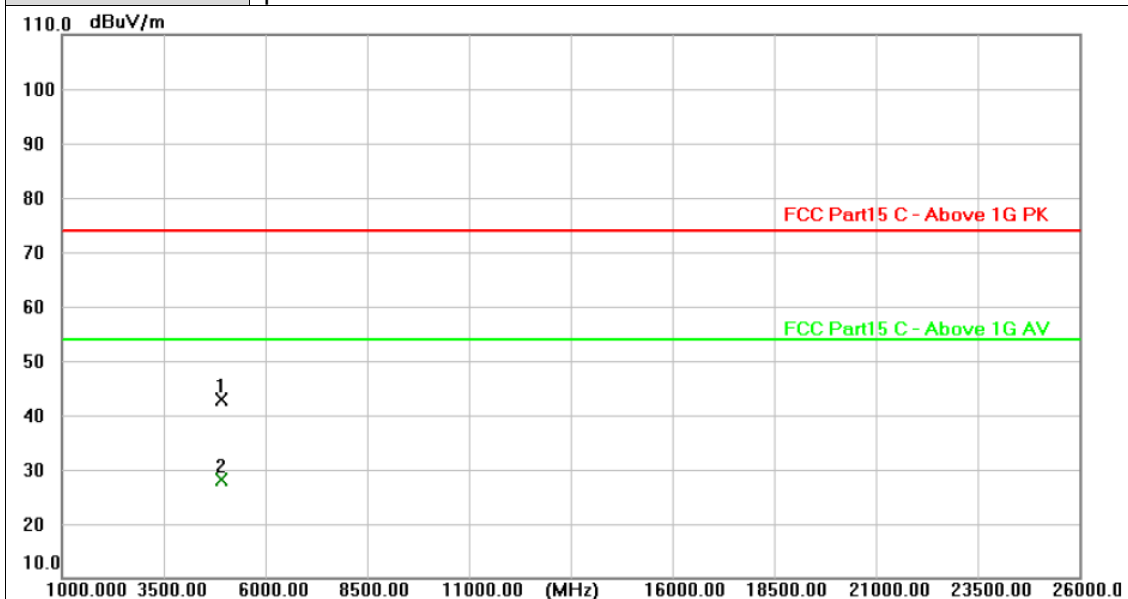

No.	Frequency (MHz)	Reading (dBuV)	Factor (dB/m)	Level (dBuV/m)	Limit (dBuV/m)	Margin (dB)	Detector
1	4923.614	40.46	2.41	42.87	74.00	-31.13	peak
2 *	4924.803	25.84	2.41	28.25	54.00	-25.75	AVG

Remarks:

- 1. Factor (dB/m) = Antenna Factor (dB/m)+Cable Factor (dB)-Pre-amplifier Factor
- 2. Margin value = Level -Limit value



Ant. Pol.	Vertical
Test Mode:	TX 802.11b Mode 2462MHz
Remark:	No report for the emission which more than 10 dB below the prescribed limit.

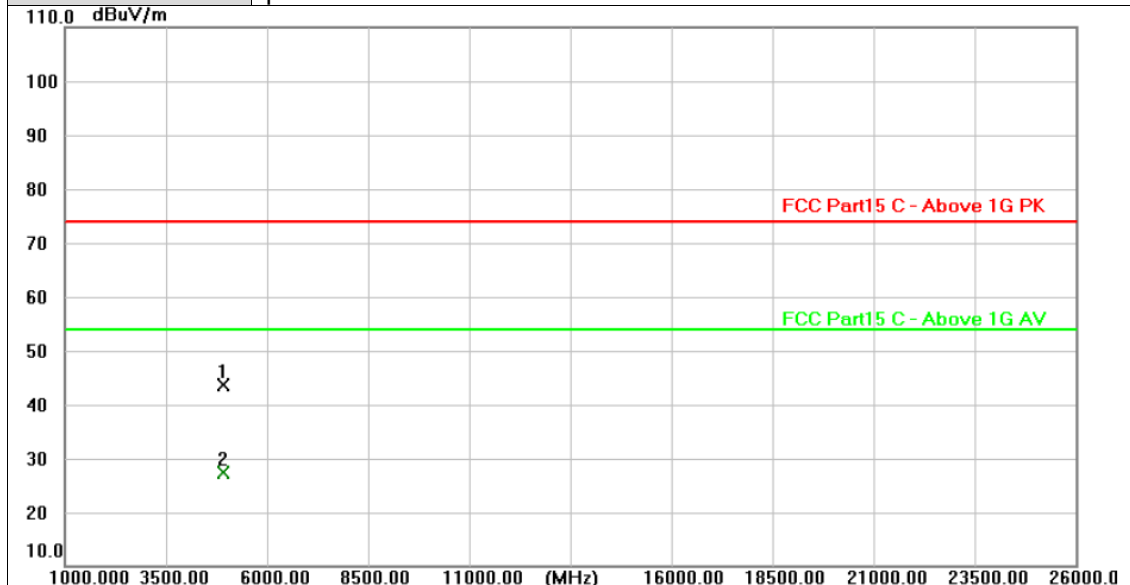

No.	Frequency (MHz)	Reading (dBuV)	Factor (dB/m)	Level (dBuV/m)	Limit (dBuV/m)	Margin (dB)	Detector
1	4923.775	41.26	2.41	43.67	74.00	-30.33	peak
2 *	4924.035	24.85	2.41	27.26	54.00	-26.74	AVG

Remarks:

- Factor (dB/m) = Antenna Factor (dB/m)+Cable Factor (dB)-Pre-amplifier Factor
- Margin value = Level -Limit value



Ant. Pol.	Horizontal
Test Mode:	TX 802.11g Mode 2412MHz
Remark:	No report for the emission which more than 10 dB below the prescribed limit.

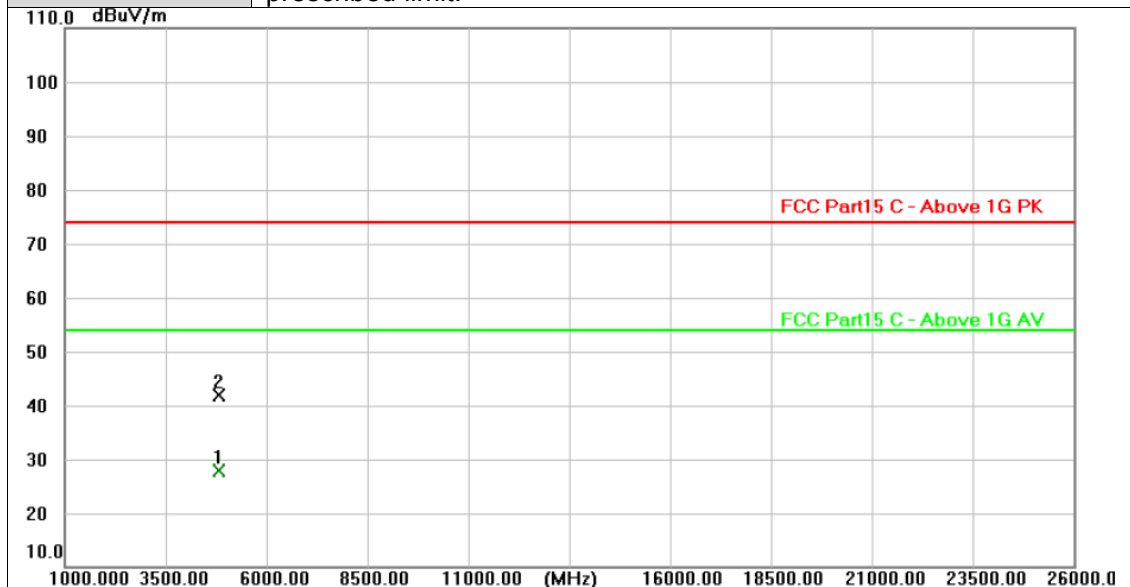

No.	Frequency (MHz)	Reading (dBuV)	Factor (dB/m)	Level (dBuV/m)	Limit (dBuV/m)	Margin (dB)	Detector
1 *	4823.405	25.71	2.20	27.91	54.00	-26.09	AVG
2	4823.900	39.70	2.20	41.90	74.00	-32.10	peak

Remarks:

- Factor (dB/m) = Antenna Factor (dB/m)+Cable Factor (dB)-Pre-amplifier Factor
- Margin value = Level -Limit value



Ant. Pol.	Vertical
Test Mode:	TX 802.11g Mode 2412MHz
Remark:	No report for the emission which more than 10 dB below the prescribed limit.

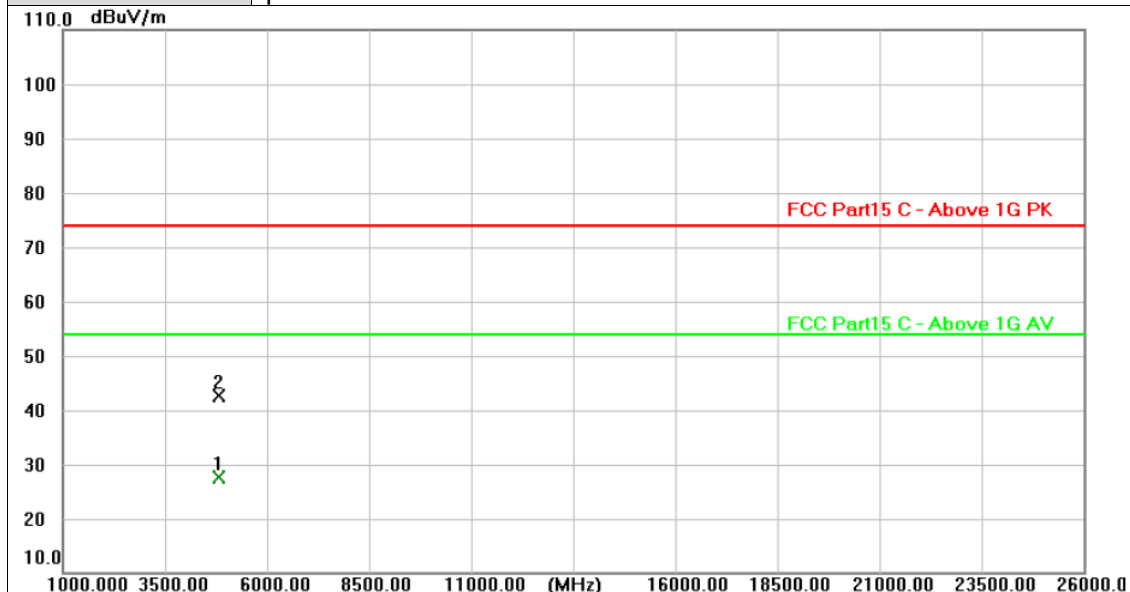

No.	Frequency (MHz)	Reading (dBuV)	Factor (dB/m)	Level (dBuV/m)	Limit (dBuV/m)	Margin (dB)	Detector
1 *	4824.295	25.32	2.20	27.52	54.00	-26.48	AVG
2	4824.813	40.52	2.20	42.72	74.00	-31.28	peak

Remarks:
 1. Factor (dB/m) = Antenna Factor (dB/m) + Cable Factor (dB) - Pre-amplifier Factor
 2. Margin value = Level - Limit value



Ant. Pol.	Horizontal
Test Mode:	TX 802.11g Mode 2437MHz
Remark:	No report for the emission which more than 10 dB below the prescribed limit.

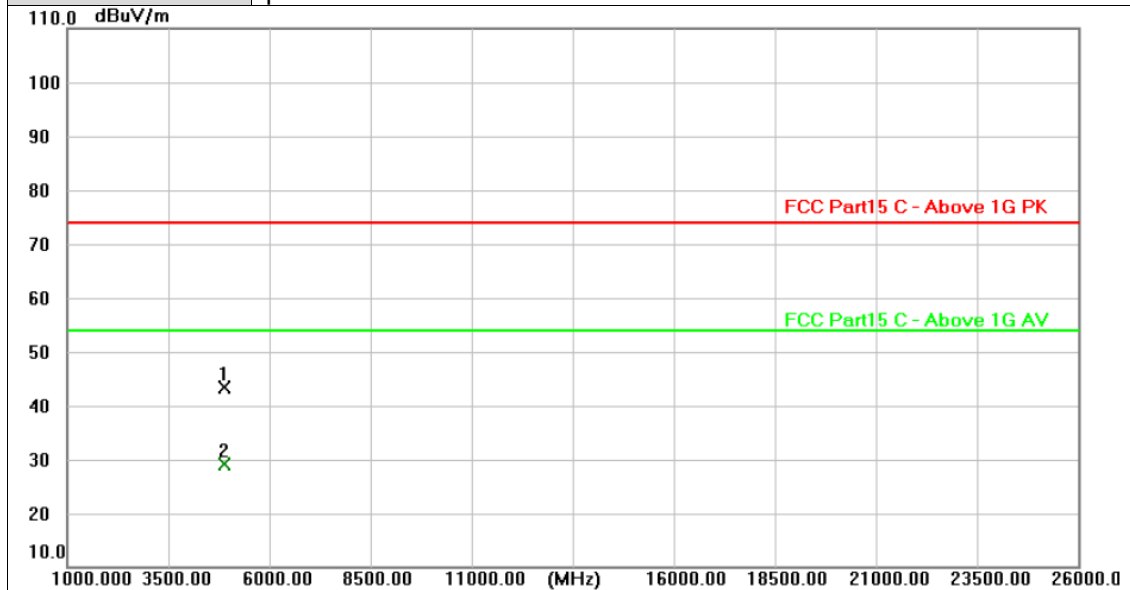

No.	Frequency (MHz)	Reading (dBuV)	Factor (dB/m)	Level (dBuV/m)	Limit (dBuV/m)	Margin (dB)	Detector
1	4873.135	41.14	2.30	43.44	74.00	-30.56	peak
2 *	4874.293	26.79	2.30	29.09	54.00	-24.91	AVG

Remarks:

1.Factor (dB/m) = Antenna Factor (dB/m)+Cable Factor (dB)-Pre-amplifier Factor

2.Margin value = Level -Limit value



Ant. Pol.	Vertical
Test Mode:	TX 802.11g Mode 2437MHz
Remark:	No report for the emission which more than 10 dB below the prescribed limit.

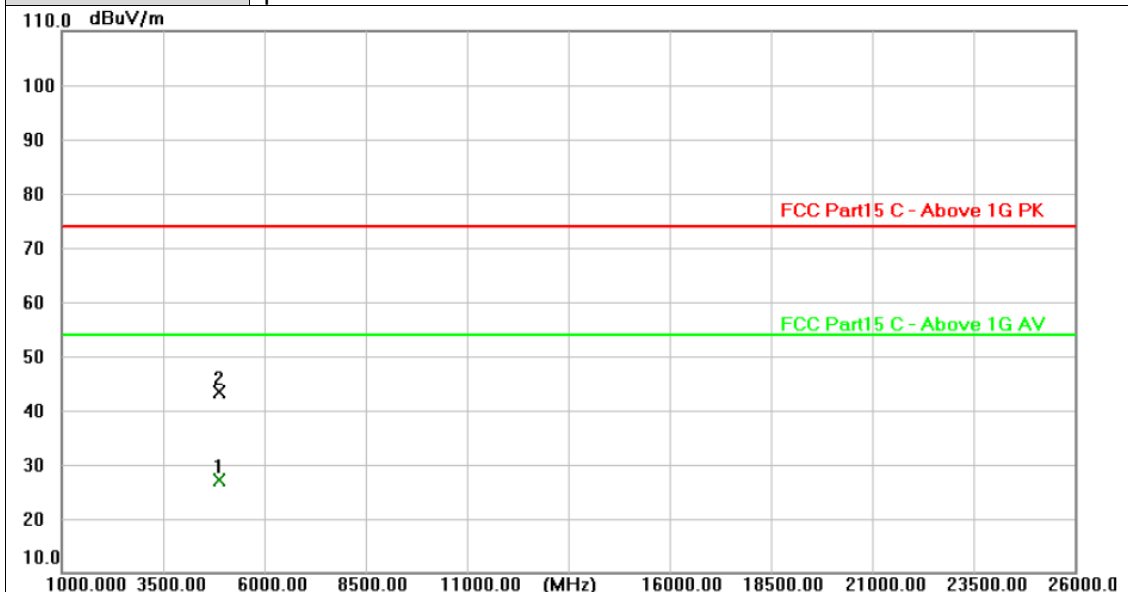

No.	Frequency (MHz)	Reading (dBuV)	Factor (dB/m)	Level (dBuV/m)	Limit (dBuV/m)	Margin (dB)	Detector
1 *	4873.587	24.83	2.30	27.13	54.00	-26.87	AVG
2	4874.888	41.05	2.30	43.35	74.00	-30.65	peak

Remarks:

- 1. Factor (dB/m) = Antenna Factor (dB/m)+Cable Factor (dB)-Pre-amplifier Factor
- 2. Margin value = Level -Limit value



Ant. Pol.	Horizontal
Test Mode:	TX 802.11g Mode 2462MHz
Remark:	No report for the emission which more than 10 dB below the prescribed limit.

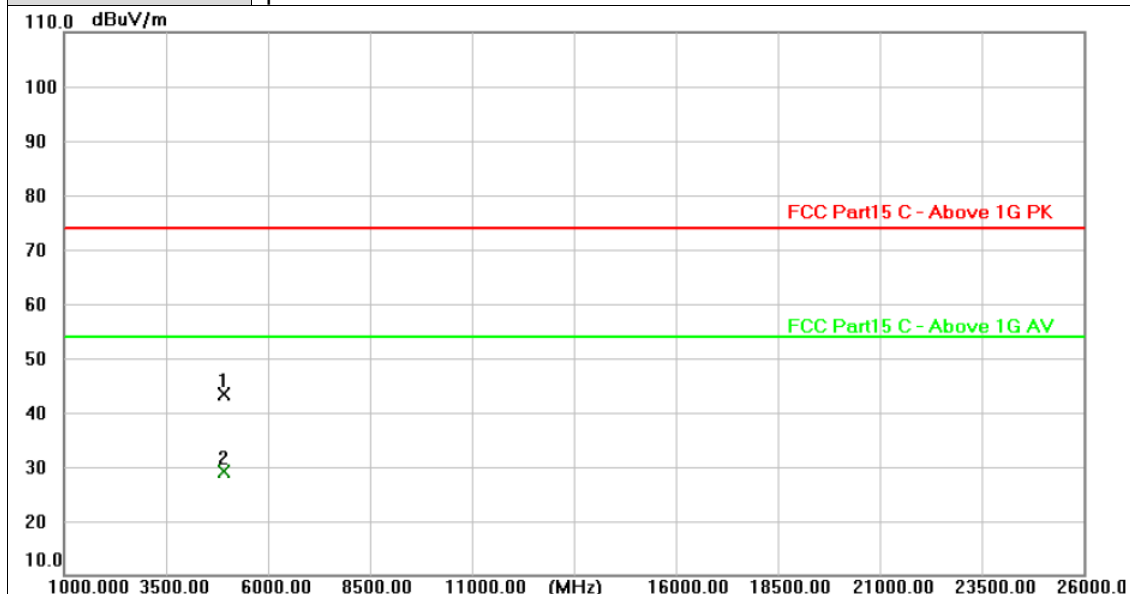

No.	Frequency (MHz)	Reading (dBuV)	Factor (dB/m)	Level (dBuV/m)	Limit (dBuV/m)	Margin (dB)	Detector
1	4923.099	40.88	2.41	43.29	74.00	-30.71	peak
2 *	4923.145	26.68	2.41	29.09	54.00	-24.91	AVG

Remarks:

1. Factor (dB/m) = Antenna Factor (dB/m) + Cable Factor (dB) - Pre-amplifier Factor
2. Margin value = Level - Limit value



Ant. Pol.	Vertical
Test Mode:	TX 802.11g Mode 2462MHz
Remark:	No report for the emission which more than 10 dB below the prescribed limit.

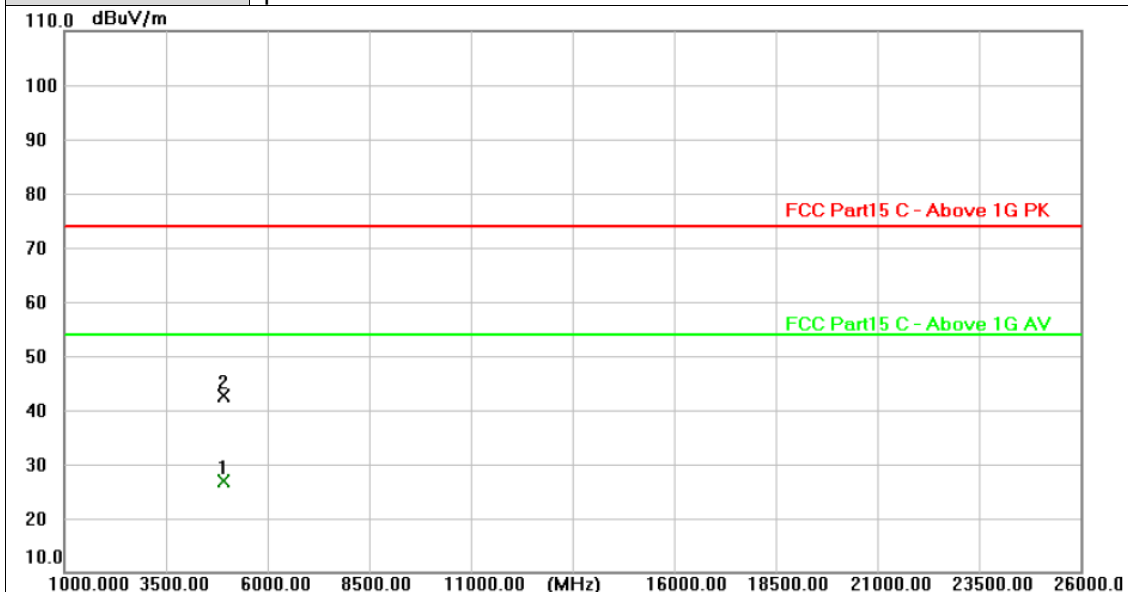

No.	Frequency (MHz)	Reading (dBuV)	Factor (dB/m)	Level (dBuV/m)	Limit (dBuV/m)	Margin (dB)	Detector
1 *	4923.861	24.52	2.41	26.93	54.00	-27.07	AVG
2	4924.544	40.26	2.41	42.67	74.00	-31.33	peak

Remarks:

- Factor (dB/m) = Antenna Factor (dB/m)+Cable Factor (dB)-Pre-amplifier Factor
- Margin value = Level -Limit value



Ant. Pol.	Horizontal
Test Mode:	TX 802.11n(HT20) Mode 2412MHz
Remark:	No report for the emission which more than 10 dB below the prescribed limit.

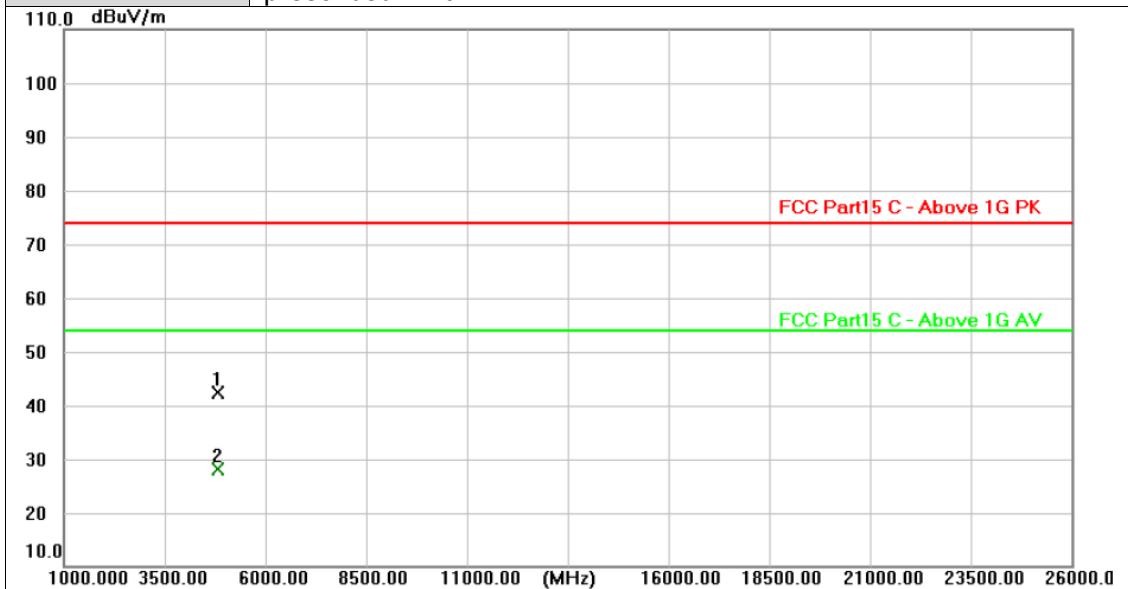

No.	Frequency (MHz)	Reading (dBuV)	Factor (dB/m)	Level (dBuV/m)	Limit (dBuV/m)	Margin (dB)	Detector
1	4824.951	40.22	2.20	42.42	74.00	-31.58	peak
2 *	4825.000	25.84	2.20	28.04	54.00	-25.96	AVG

Remarks:

- 1. Factor (dB/m) = Antenna Factor (dB/m)+Cable Factor (dB)-Pre-amplifier Factor
- 2. Margin value = Level -Limit value



Ant. Pol.	Vertical
Test Mode:	TX 802.11n(HT20) Mode 2412MHz
Remark:	No report for the emission which more than 10 dB below the prescribed limit.

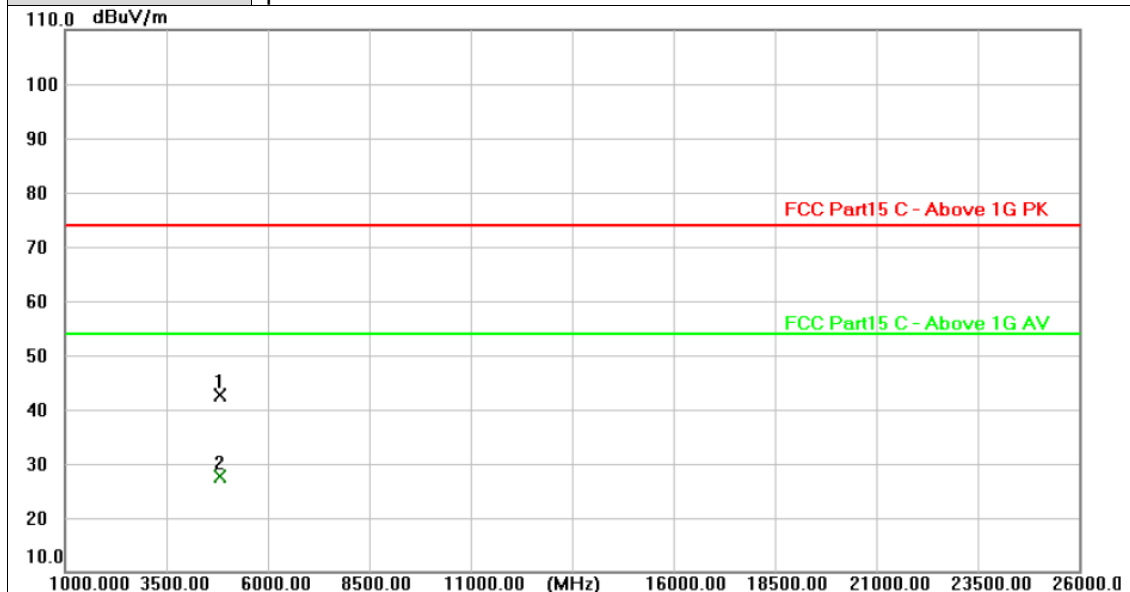

No.	Frequency (MHz)	Reading (dBuV)	Factor (dB/m)	Level (dBuV/m)	Limit (dBuV/m)	Margin (dB)	Detector
1	4823.025	40.37	2.20	42.57	74.00	-31.43	peak
2 *	4823.229	25.45	2.20	27.65	54.00	-26.35	AVG

Remarks:

- 1.Factor (dB/m) = Antenna Factor (dB/m)+Cable Factor (dB)-Pre-amplifier Factor
- 2.Margin value = Level -Limit value



Ant. Pol.	Horizontal
Test Mode:	TX 802.11n(HT20) Mode 2437MHz
Remark:	No report for the emission which more than 10 dB below the prescribed limit.

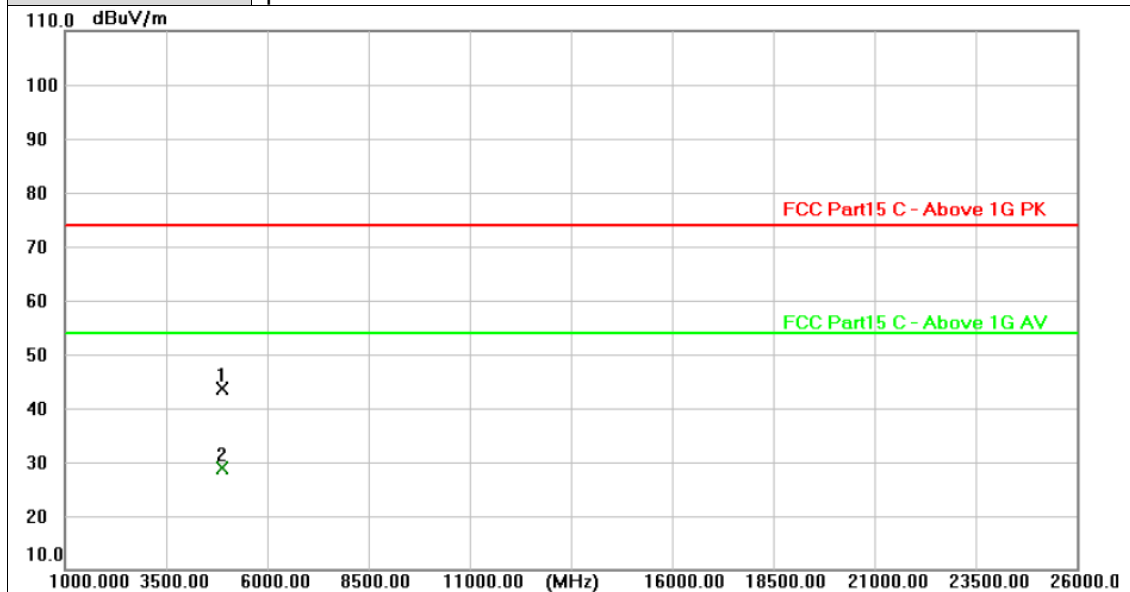

No.	Frequency (MHz)	Reading (dBuV)	Factor (dB/m)	Level (dBuV/m)	Limit (dBuV/m)	Margin (dB)	Detector
1	4873.707	41.40	2.30	43.70	74.00	-30.30	peak
2 *	4874.895	26.67	2.30	28.97	54.00	-25.03	AVG

Remarks:
 1.Factor (dB/m) = Antenna Factor (dB/m)+Cable Factor (dB)-Pre-amplifier Factor
 2.Margin value = Level -Limit value



Ant. Pol.	Vertical
Test Mode:	TX 802.11n(HT20) Mode 2437MHz
Remark:	No report for the emission which more than 10 dB below the prescribed limit.

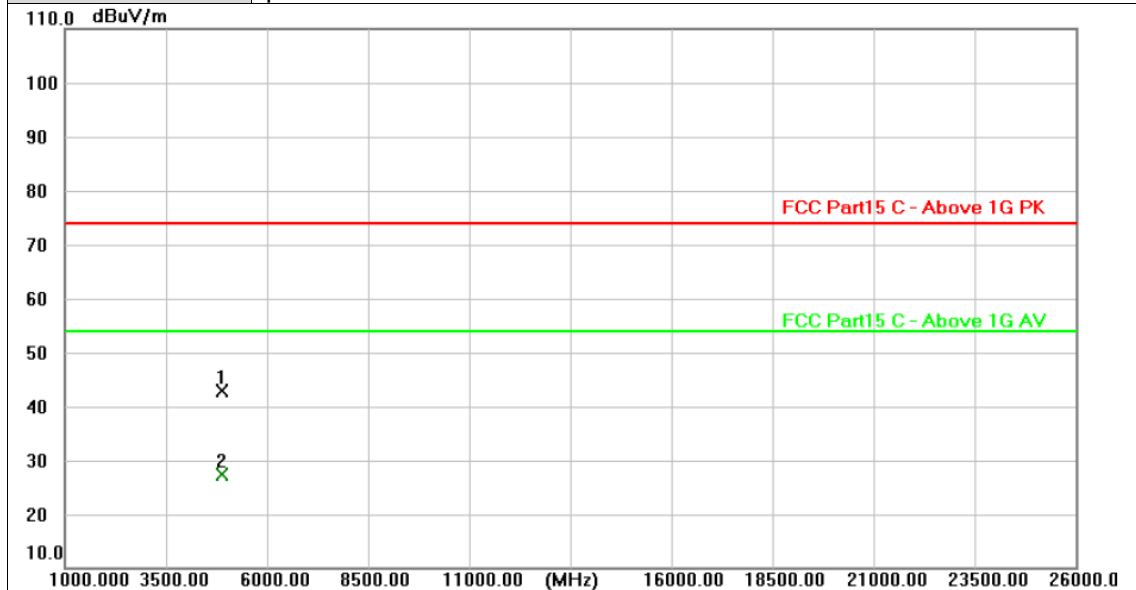

No.	Frequency (MHz)	Reading (dBuV)	Factor (dB/m)	Level (dBuV/m)	Limit (dBuV/m)	Margin (dB)	Detector
1	4873.527	40.60	2.30	42.90	74.00	-31.10	peak
2 *	4874.465	25.16	2.30	27.46	54.00	-26.54	AVG

Remarks:

- 1.Factor (dB/m) = Antenna Factor (dB/m)+Cable Factor (dB)-Pre-amplifier Factor
- 2.Margin value = Level -Limit value



Ant. Pol.	Horizontal
Test Mode:	TX 802.11n(HT20) Mode 2462MHz
Remark:	No report for the emission which more than 10 dB below the prescribed limit.

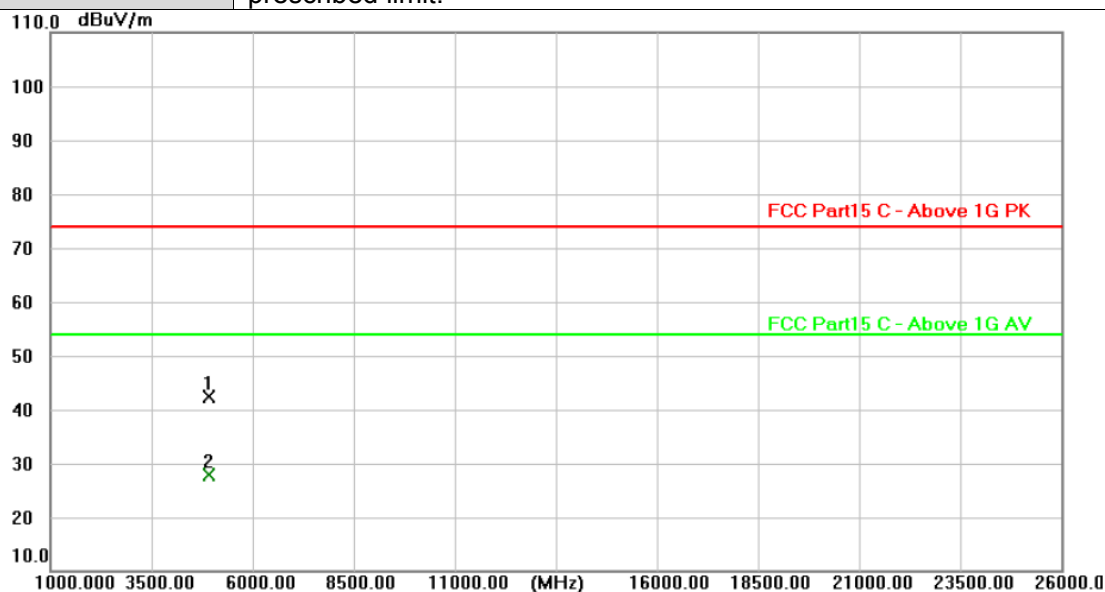

No.	Frequency (MHz)	Reading (dBuV)	Factor (dB/m)	Level (dBuV/m)	Limit (dBuV/m)	Margin (dB)	Detector
1	4923.037	39.95	2.41	42.36	74.00	-31.64	peak
2 *	4925.000	25.52	2.41	27.93	54.00	-26.07	AVG

Remarks:

- 1. Factor (dB/m) = Antenna Factor (dB/m)+Cable Factor (dB)-Pre-amplifier Factor
- 2. Margin value = Level -Limit value



Ant. Pol.	Vertical
Test Mode:	TX 802.11n(HT20) Mode 2462MHz
Remark:	No report for the emission which more than 10 dB below the prescribed limit.

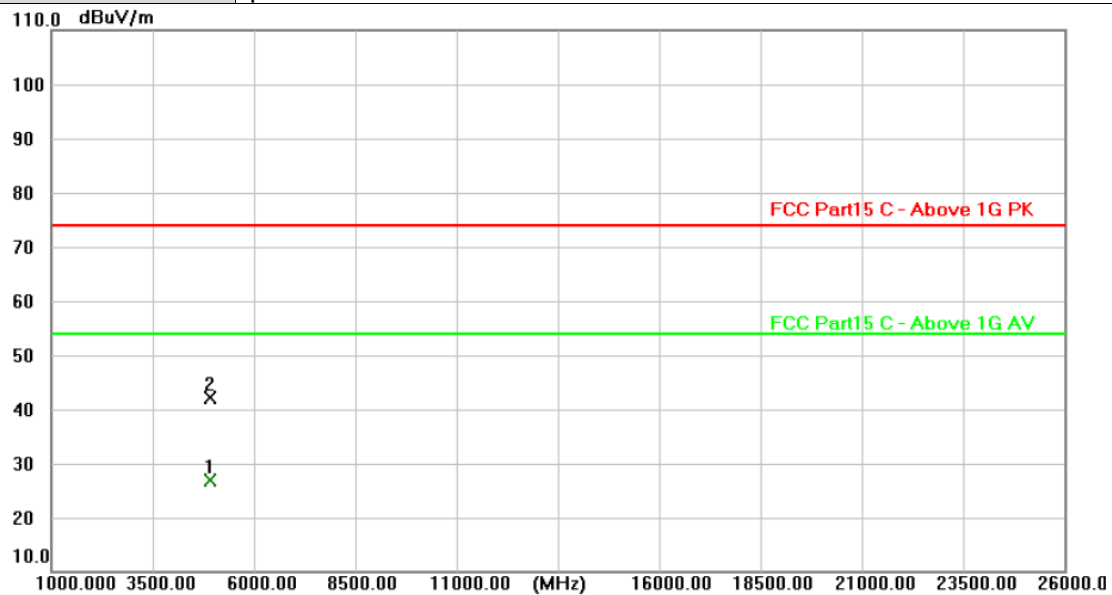

No.	Frequency (MHz)	Reading (dBuV)	Factor (dB/m)	Level (dBuV/m)	Limit (dBuV/m)	Margin (dB)	Detector
1 *	4923.851	24.48	2.41	26.89	54.00	-27.11	AVG
2	4924.594	39.70	2.41	42.11	74.00	-31.89	peak

Remarks:

- Factor (dB/m) = Antenna Factor (dB/m)+Cable Factor (dB)-Pre-amplifier Factor
- Margin value = Level -Limit value



Ant. Pol.	Horizontal
Test Mode:	TX 802.11n(HT40) Mode 2422MHz
Remark:	No report for the emission which more than 10 dB below the prescribed limit.

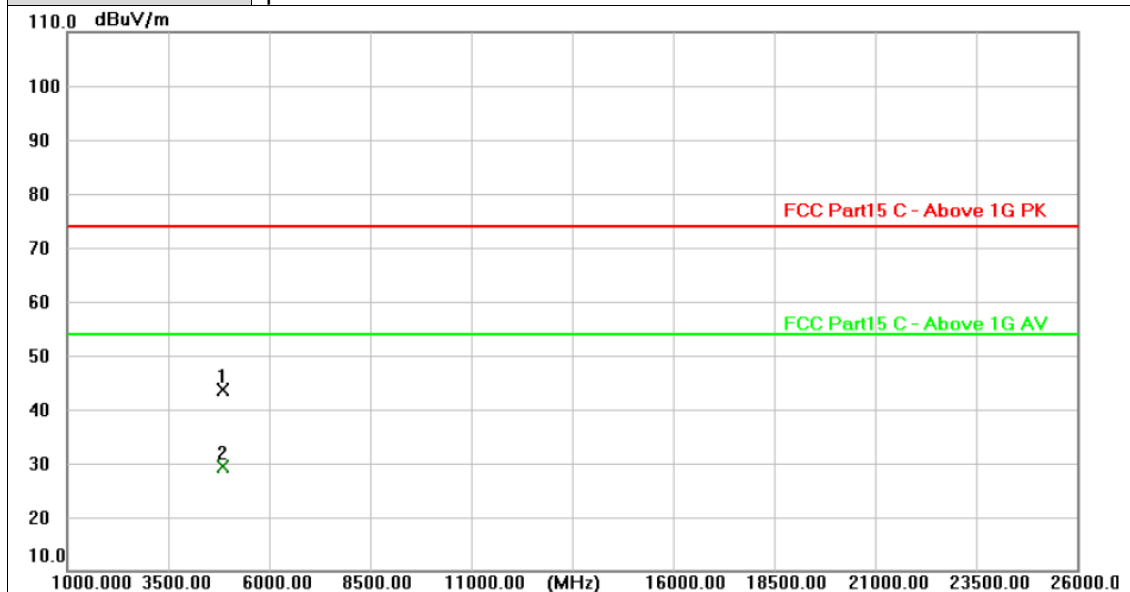

No.	Frequency (MHz)	Reading (dBuV)	Factor (dB/m)	Level (dBuV/m)	Limit (dBuV/m)	Margin (dB)	Detector
1	4843.358	41.35	2.24	43.59	74.00	-30.41	peak
2 *	4844.501	27.16	2.24	29.40	54.00	-24.60	AVG

Remarks:
 1. Factor (dB/m) = Antenna Factor (dB/m)+Cable Factor (dB)-Pre-amplifier Factor
 2. Margin value = Level -Limit value



Ant. Pol.	Vertical
Test Mode:	TX 802.11n(HT40) Mode 2422MHz
Remark:	No report for the emission which more than 10 dB below the prescribed limit.

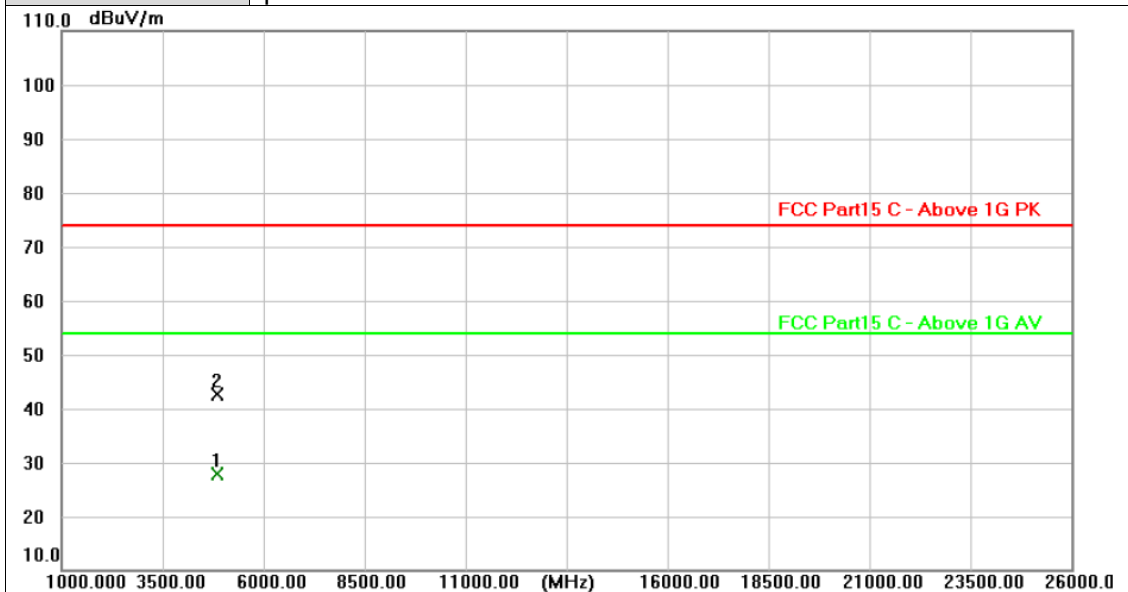

No.	Frequency (MHz)	Reading (dBuV)	Factor (dB/m)	Level (dBuV/m)	Limit (dBuV/m)	Margin (dB)	Detector
1 *	4843.294	25.72	2.24	27.96	54.00	-26.04	AVG
2	4843.555	40.29	2.24	42.53	74.00	-31.47	peak

Remarks:

- 1.Factor (dB/m) = Antenna Factor (dB/m)+Cable Factor (dB)-Pre-amplifier Factor
- 2.Margin value = Level -Limit value



Ant. Pol.	Horizontal
Test Mode:	TX 802.11n(HT40) Mode 2437MHz
Remark:	No report for the emission which more than 10 dB below the prescribed limit.

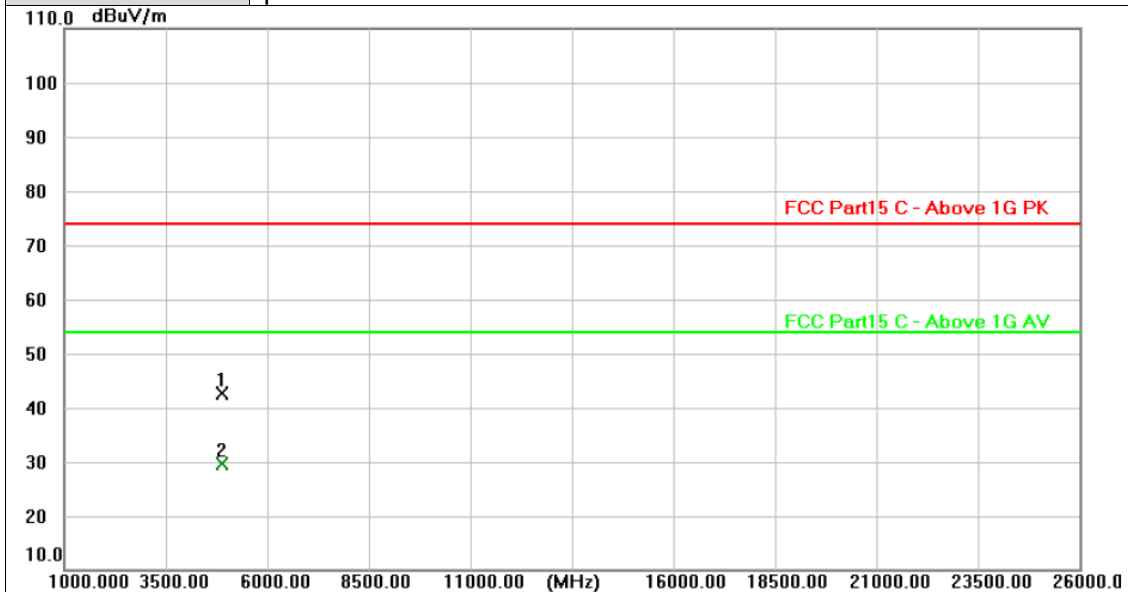

No.	Frequency (MHz)	Reading (dBuV)	Factor (dB/m)	Level (dBuV/m)	Limit (dBuV/m)	Margin (dB)	Detector
1	4873.397	40.31	2.30	42.61	74.00	-31.39	peak
2 *	4874.609	27.40	2.30	29.70	54.00	-24.30	AVG

Remarks:

- 1. Factor (dB/m) = Antenna Factor (dB/m)+Cable Factor (dB)-Pre-amplifier Factor
- 2. Margin value = Level -Limit value



Ant. Pol.	Vertical
Test Mode:	TX 802.11n(HT40) Mode 2437MHz
Remark:	No report for the emission which more than 10 dB below the prescribed limit.

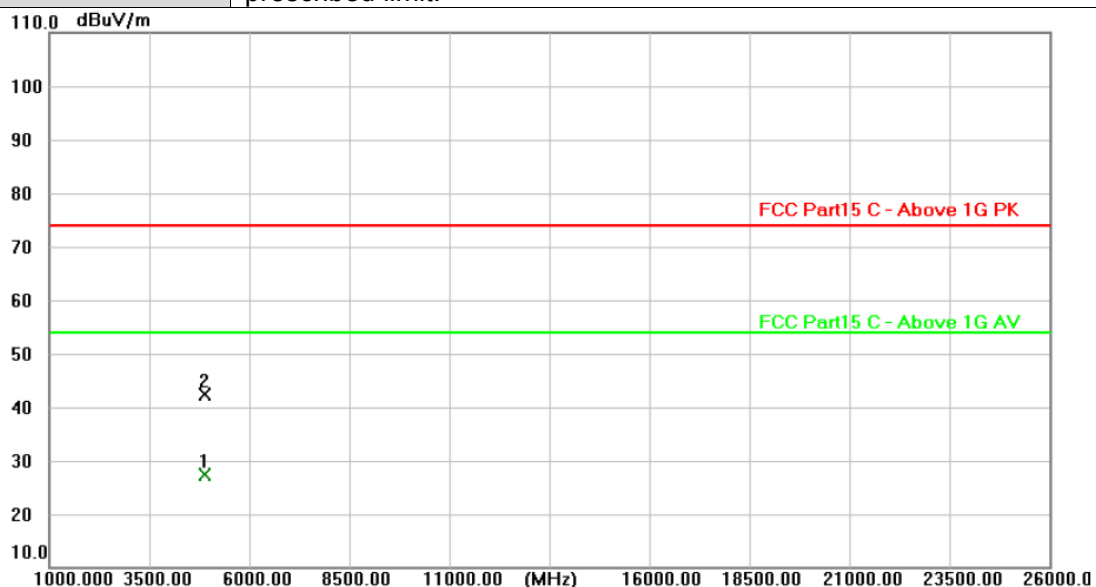

No.	Frequency (MHz)	Reading (dBuV)	Factor (dB/m)	Level (dBuV/m)	Limit (dBuV/m)	Margin (dB)	Detector
1 *	4874.116	25.17	2.30	27.47	54.00	-26.53	AVG
2	4874.713	40.12	2.30	42.42	74.00	-31.58	peak

Remarks:

- Factor (dB/m) = Antenna Factor (dB/m)+Cable Factor (dB)-Pre-amplifier Factor
- Margin value = Level -Limit value



Ant. Pol.	Horizontal
Test Mode:	TX 802.11n(HT40) Mode 2452MHz
Remark:	No report for the emission which more than 10 dB below the prescribed limit.

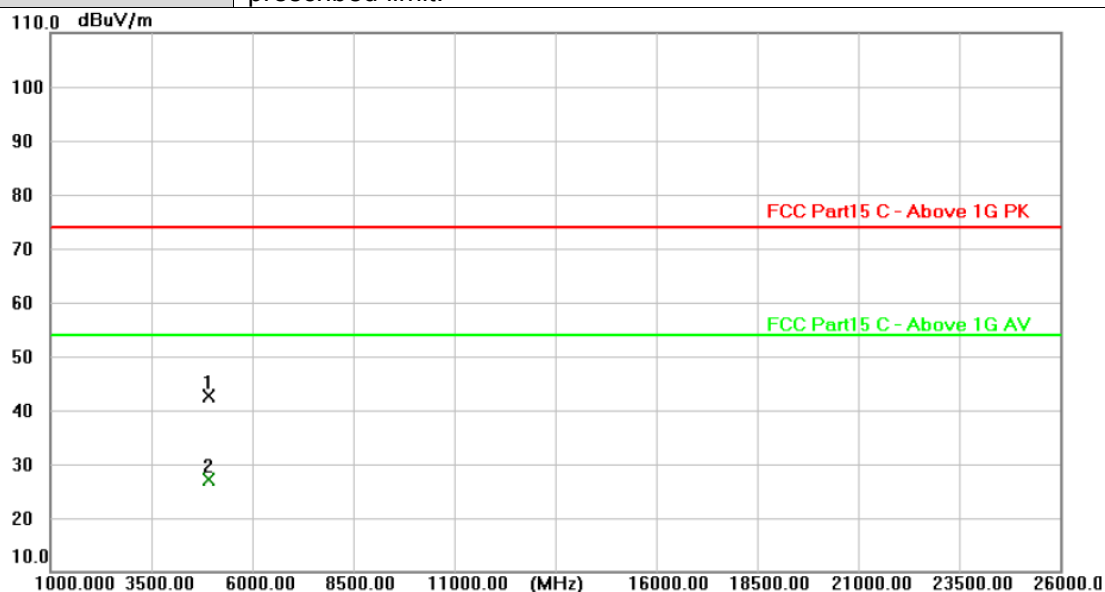

No.	Frequency (MHz)	Reading (dBuV)	Factor (dB/m)	Level (dBuV/m)	Limit (dBuV/m)	Margin (dB)	Detector
1	4903.417	40.24	2.36	42.60	74.00	-31.40	peak
2 *	4904.492	24.89	2.36	27.25	54.00	-26.75	AVG

Remarks:

- Factor (dB/m) = Antenna Factor (dB/m)+Cable Factor (dB)-Pre-amplifier Factor
- Margin value = Level -Limit value



Ant. Pol.	Vertical
Test Mode:	TX 802.11n(HT40) Mode 2452MHz
Remark:	No report for the emission which more than 10 dB below the prescribed limit.

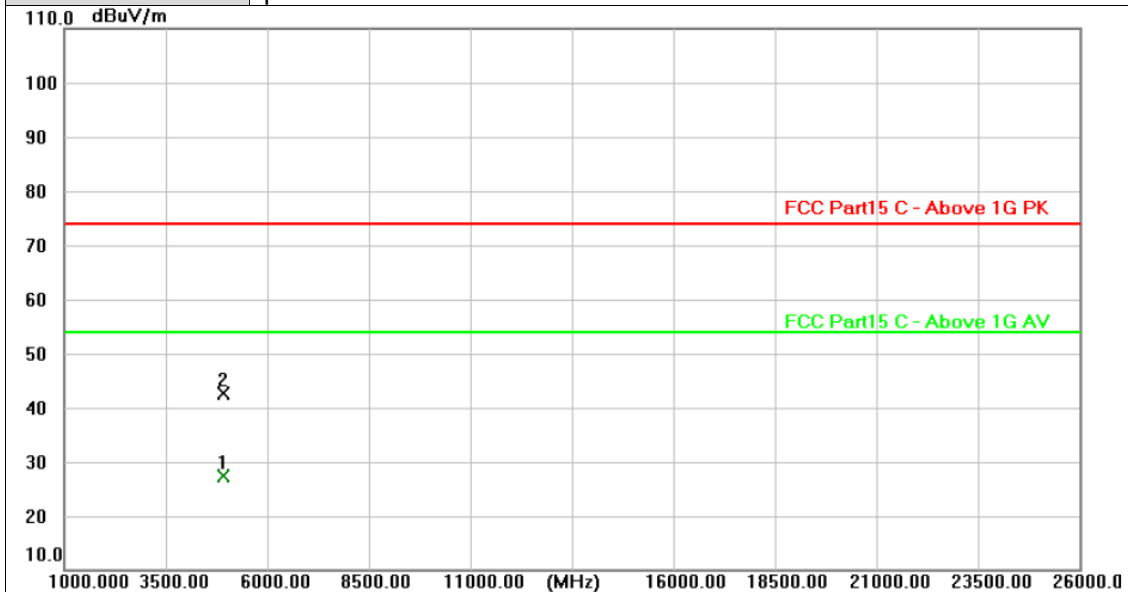

No.	Frequency (MHz)	Reading (dBuV)	Factor (dB/m)	Level (dBuV/m)	Limit (dBuV/m)	Margin (dB)	Detector
1 *	4903.503	24.94	2.36	27.30	54.00	-26.70	AVG
2	4904.745	40.27	2.36	42.63	74.00	-31.37	peak

Remarks:

- 1. Factor (dB/m) = Antenna Factor (dB/m)+Cable Factor (dB)-Pre-amplifier Factor
- 2. Margin value = Level -Limit value



Ant. Pol.	Horizontal
Test Mode:	TX 802.11ax(HE20) Mode 2412MHz
Remark:	No report for the emission which more than 10 dB below the prescribed limit.

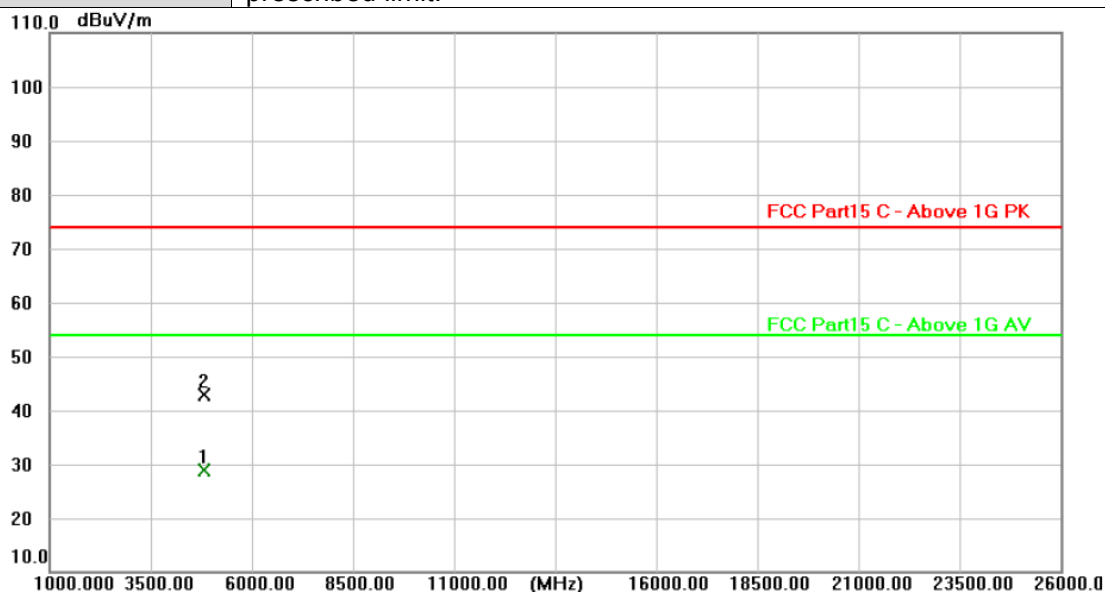

No.	Frequency (MHz)	Reading (dBuV)	Factor (dB/m)	Level (dBuV/m)	Limit (dBuV/m)	Margin (dB)	Detector
1 *	4823.479	26.62	2.20	28.82	54.00	-25.18	AVG
2	4824.617	40.77	2.20	42.97	74.00	-31.03	peak

Remarks:

- 1. Factor (dB/m) = Antenna Factor (dB/m)+Cable Factor (dB)-Pre-amplifier Factor
- 2. Margin value = Level -Limit value



Ant. Pol.	Vertical
Test Mode:	TX 802.11ax(HE20) Mode 2412MHz
Remark:	No report for the emission which more than 10 dB below the prescribed limit.

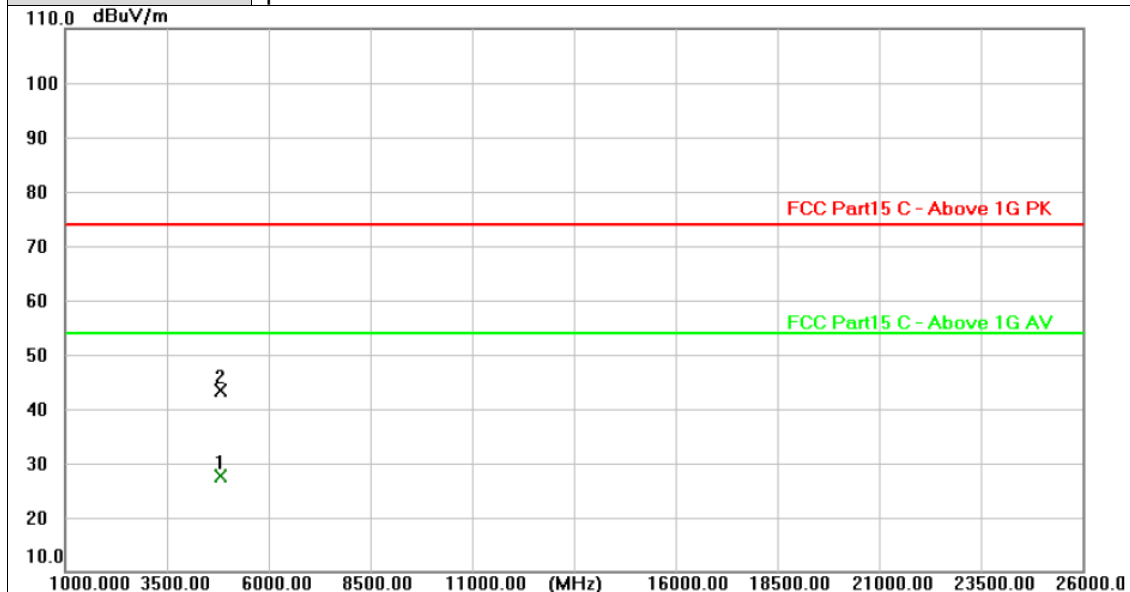

No.	Frequency (MHz)	Reading (dBuV)	Factor (dB/m)	Level (dBuV/m)	Limit (dBuV/m)	Margin (dB)	Detector
1 *	4823.827	25.53	2.20	27.73	54.00	-26.27	AVG
2	4824.115	41.16	2.20	43.36	74.00	-30.64	peak

Remarks:

- 1. Factor (dB/m) = Antenna Factor (dB/m)+Cable Factor (dB)-Pre-amplifier Factor
- 2. Margin value = Level -Limit value



Ant. Pol.	Horizontal
Test Mode:	TX 802.11ax(HE20) Mode 2437MHz
Remark:	No report for the emission which more than 10 dB below the prescribed limit.

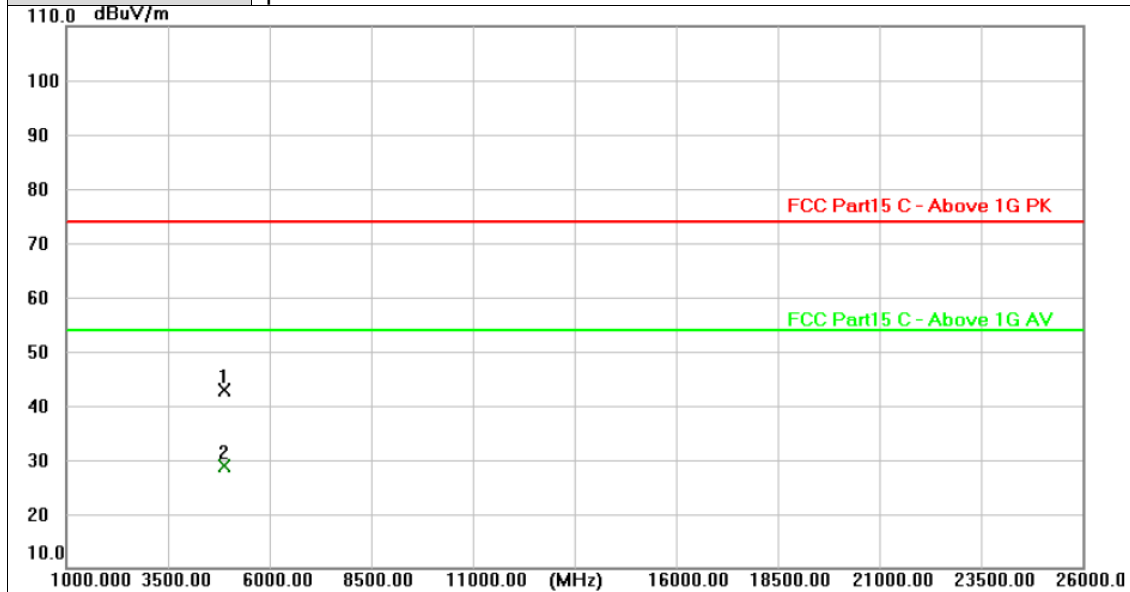

No.	Frequency (MHz)	Reading (dBuV)	Factor (dB/m)	Level (dBuV/m)	Limit (dBuV/m)	Margin (dB)	Detector
1	4873.797	40.65	2.30	42.95	74.00	-31.05	peak
2 *	4874.127	26.57	2.30	28.87	54.00	-25.13	AVG

Remarks:
 1. Factor (dB/m) = Antenna Factor (dB/m)+Cable Factor (dB)-Pre-amplifier Factor
 2. Margin value = Level -Limit value



Ant. Pol.	Vertical
Test Mode:	TX 802.11ax(HE20) Mode 2437MHz
Remark:	No report for the emission which more than 10 dB below the prescribed limit.

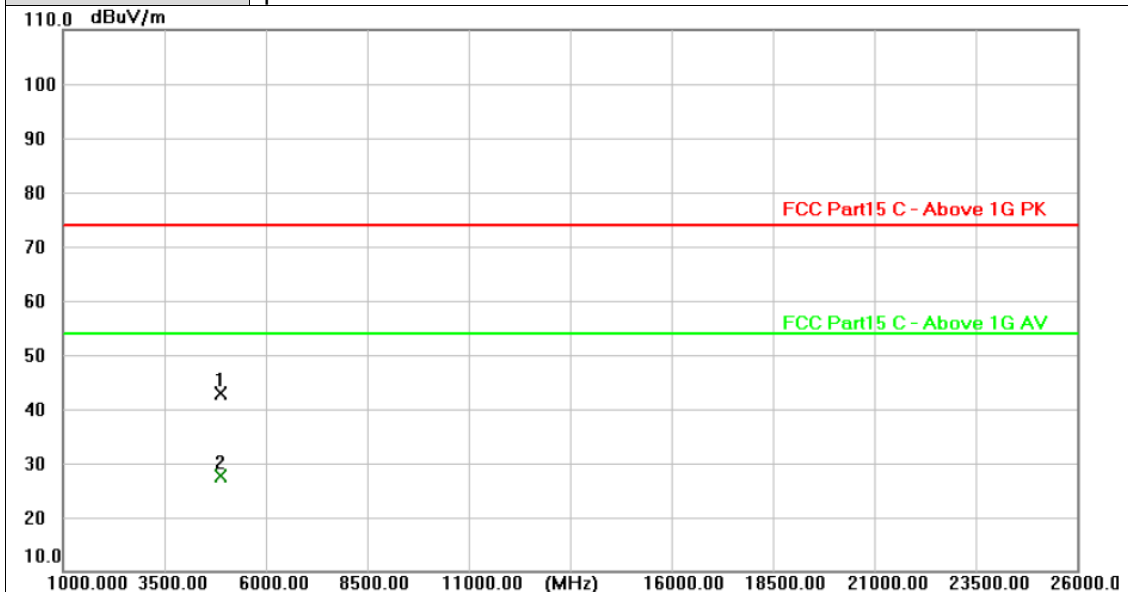

No.	Frequency (MHz)	Reading (dBuV)	Factor (dB/m)	Level (dBuV/m)	Limit (dBuV/m)	Margin (dB)	Detector
1	4873.955	40.49	2.30	42.79	74.00	-31.21	peak
2 *	4874.809	25.24	2.30	27.54	54.00	-26.46	AVG

Remarks:

- 1. Factor (dB/m) = Antenna Factor (dB/m)+Cable Factor (dB)-Pre-amplifier Factor
- 2. Margin value = Level -Limit value



Ant. Pol.	Horizontal
Test Mode:	TX 802.11ax(HE20) Mode 2462MHz
Remark:	No report for the emission which more than 10 dB below the prescribed limit.

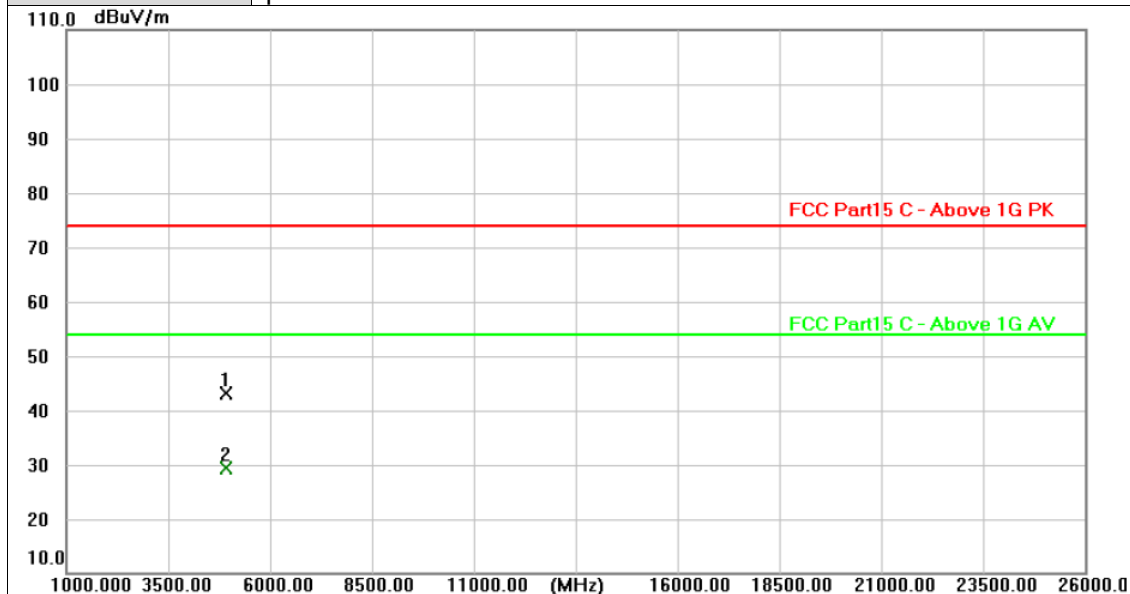

No.	Frequency (MHz)	Reading (dBuV)	Factor (dB/m)	Level (dBuV/m)	Limit (dBuV/m)	Margin (dB)	Detector
1	4923.128	40.70	2.41	43.11	74.00	-30.89	peak
2 *	4924.282	26.91	2.41	29.32	54.00	-24.68	AVG

Remarks:
 1. Factor (dB/m) = Antenna Factor (dB/m)+Cable Factor (dB)-Pre-amplifier Factor
 2. Margin value = Level -Limit value



Ant. Pol.	Vertical
Test Mode:	TX 802.11ax(HE20) Mode 2462MHz
Remark:	No report for the emission which more than 10 dB below the prescribed limit.

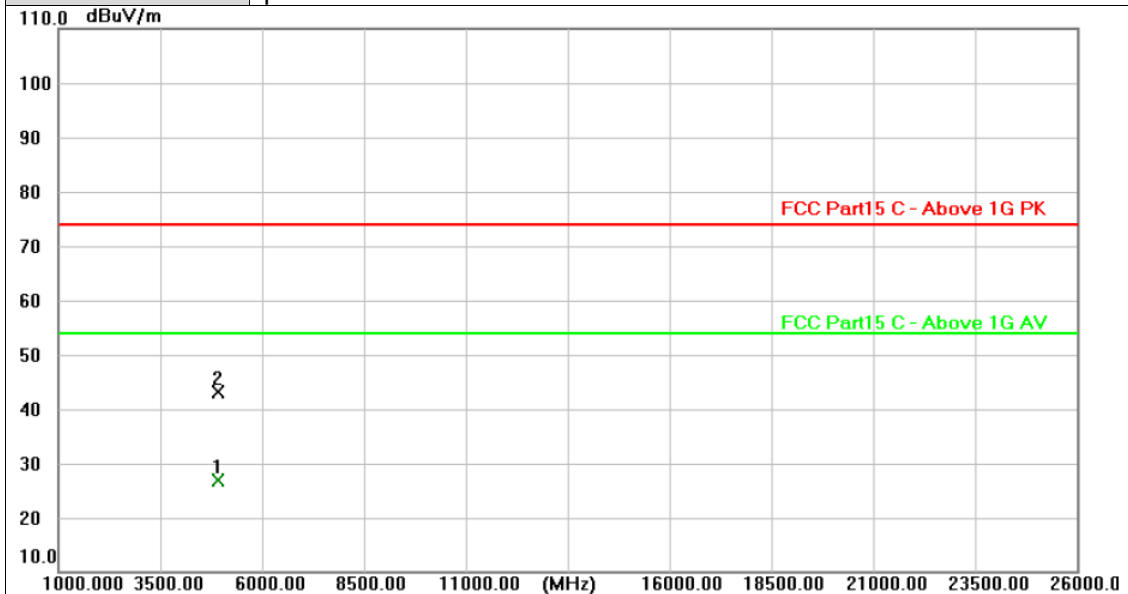

No.	Frequency (MHz)	Reading (dBuV)	Factor (dB/m)	Level (dBuV/m)	Limit (dBuV/m)	Margin (dB)	Detector
1 *	4923.355	24.50	2.41	26.91	54.00	-27.09	AVG
2	4924.304	40.83	2.41	43.24	74.00	-30.76	peak

Remarks:
 1. Factor (dB/m) = Antenna Factor (dB/m)+Cable Factor (dB)-Pre-amplifier Factor
 2. Margin value = Level -Limit value



Ant. Pol.	Horizontal
Test Mode:	TX 802.11ax(HE40) Mode 2422MHz
Remark:	No report for the emission which more than 10 dB below the prescribed limit.

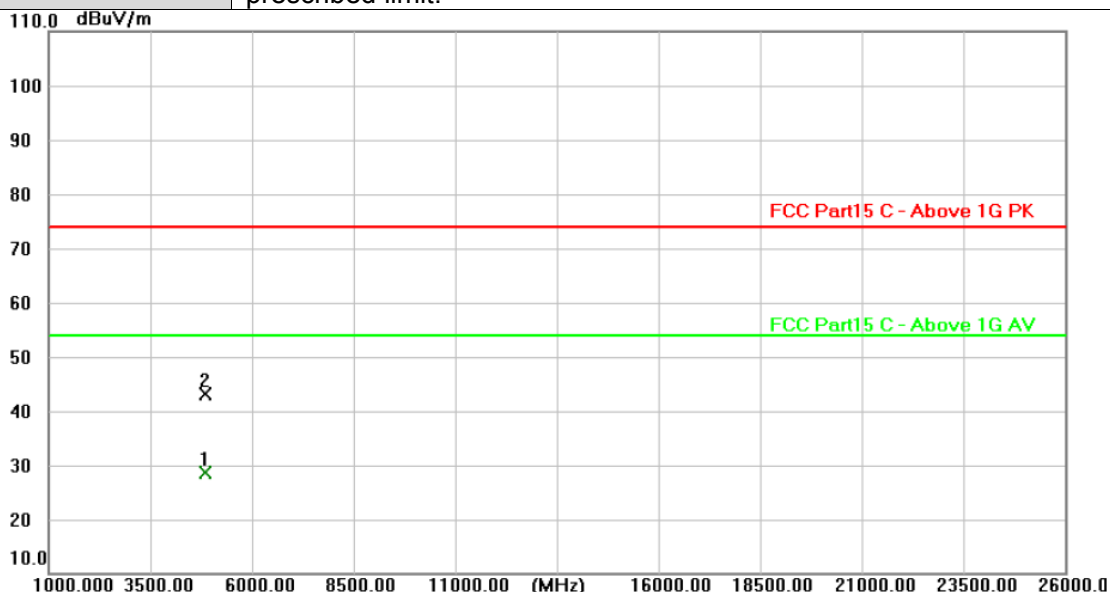

No.	Frequency (MHz)	Reading (dBuV)	Factor (dB/m)	Level (dBuV/m)	Limit (dBuV/m)	Margin (dB)	Detector
1 *	4844.296	26.37	2.24	28.61	54.00	-25.39	AVG
2	4844.811	40.94	2.24	43.18	74.00	-30.82	peak

Remarks:

- Factor (dB/m) = Antenna Factor (dB/m)+Cable Factor (dB)-Pre-amplifier Factor
- Margin value = Level -Limit value



Ant. Pol.	Vertical
Test Mode:	TX 802.11ax(HE40) Mode 2422MHz
Remark:	No report for the emission which more than 10 dB below the prescribed limit.

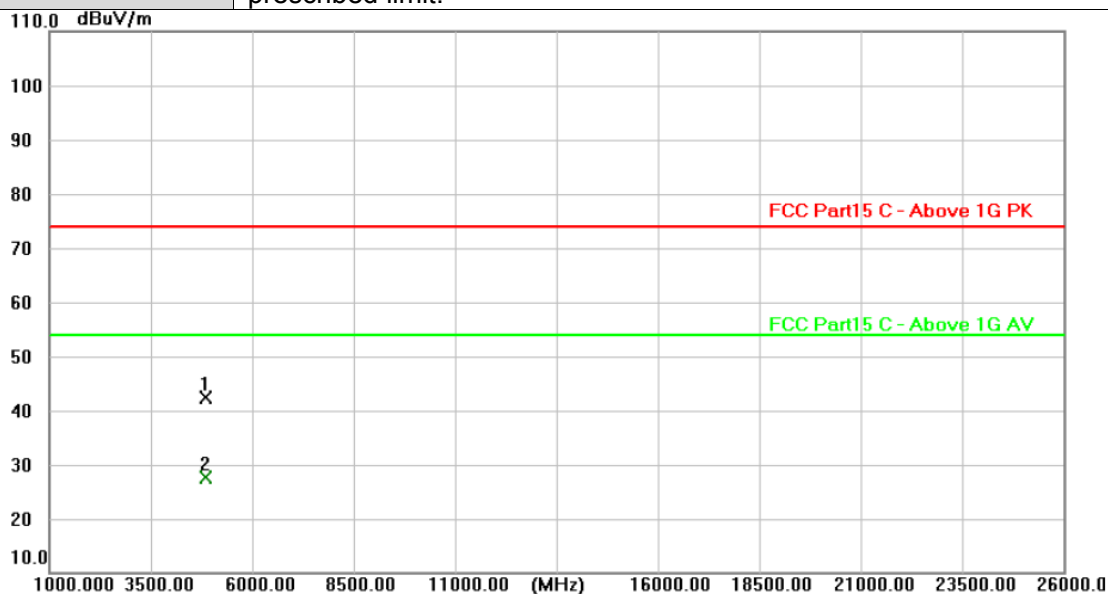

No.	Frequency (MHz)	Reading (dBuV)	Factor (dB/m)	Level (dBuV/m)	Limit (dBuV/m)	Margin (dB)	Detector
1	4843.721	40.05	2.24	42.29	74.00	-31.71	peak
2 *	4844.311	25.34	2.24	27.58	54.00	-26.42	AVG

Remarks:

- 1.Factor (dB/m) = Antenna Factor (dB/m)+Cable Factor (dB)-Pre-amplifier Factor
- 2.Margin value = Level -Limit value



Ant. Pol.	Horizontal
Test Mode:	TX 802.11ax(HE40) Mode 2437MHz
Remark:	No report for the emission which more than 10 dB below the prescribed limit.

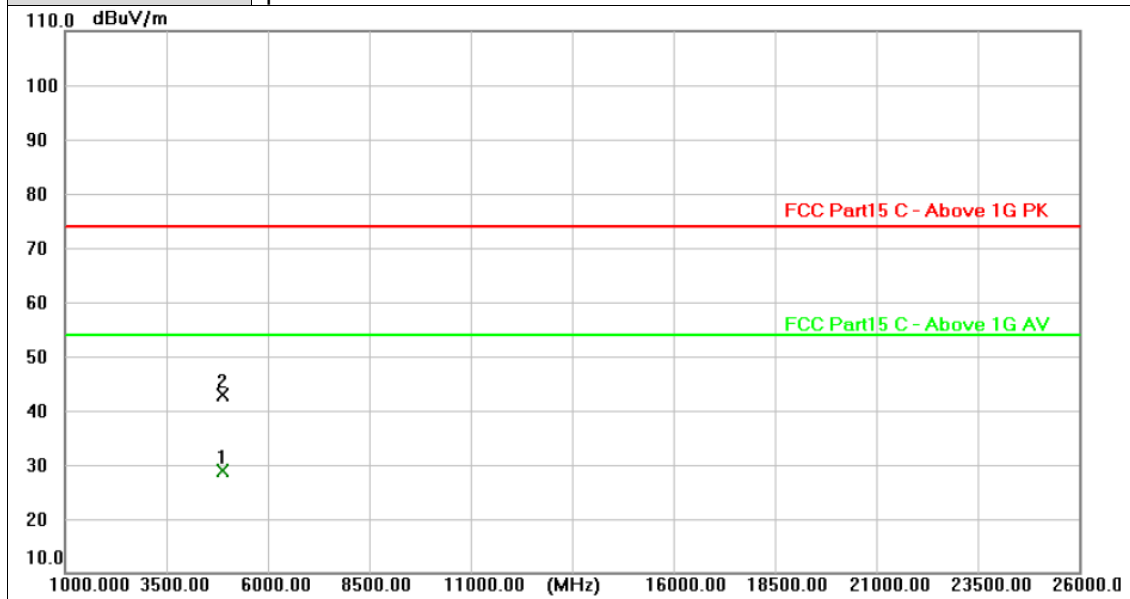

No.	Frequency (MHz)	Reading (dBuV)	Factor (dB/m)	Level (dBuV/m)	Limit (dBuV/m)	Margin (dB)	Detector
1 *	4874.500	26.67	2.30	28.97	54.00	-25.03	AVG
2	4874.833	40.47	2.30	42.77	74.00	-31.23	peak

Remarks:
 1. Factor (dB/m) = Antenna Factor (dB/m)+Cable Factor (dB)-Pre-amplifier Factor
 2. Margin value = Level -Limit value



Ant. Pol.	Vertical
Test Mode:	TX 802.11ax(HE40) Mode 2437MHz
Remark:	No report for the emission which more than 10 dB below the prescribed limit.

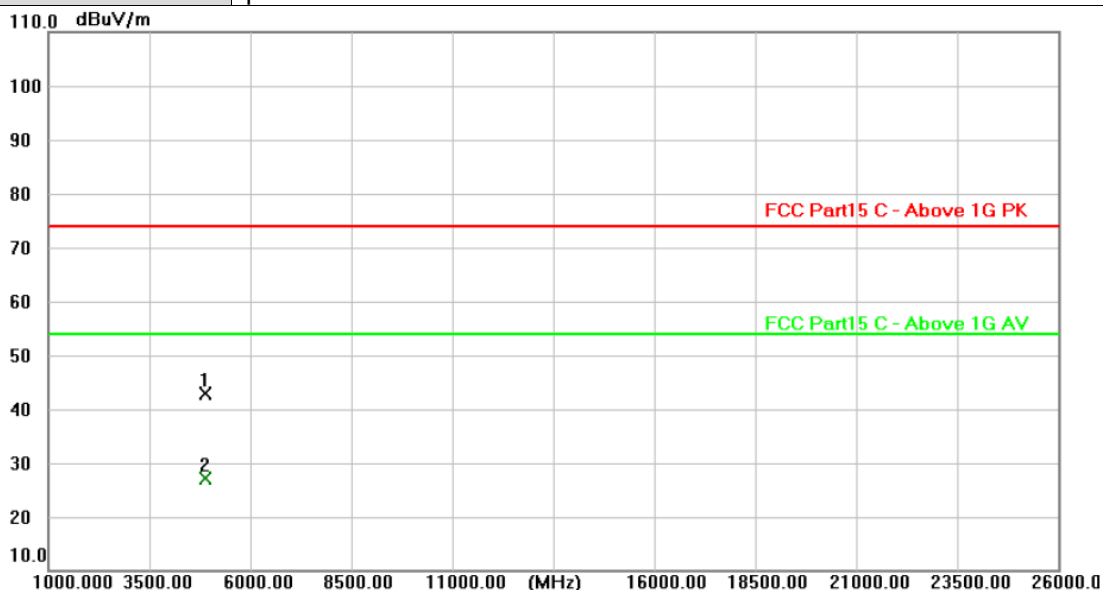

No.	Frequency (MHz)	Reading (dBuV)	Factor (dB/m)	Level (dBuV/m)	Limit (dBuV/m)	Margin (dB)	Detector
1	4873.579	40.48	2.30	42.78	74.00	-31.22	peak
2 *	4874.780	24.94	2.30	27.24	54.00	-26.76	AVG

Remarks:

- 1.Factor (dB/m) = Antenna Factor (dB/m)+Cable Factor (dB)-Pre-amplifier Factor
- 2.Margin value = Level -Limit value



Ant. Pol.	Horizontal
Test Mode:	TX 802.11ax(HE40) Mode 2452MHz
Remark:	No report for the emission which more than 10 dB below the prescribed limit.

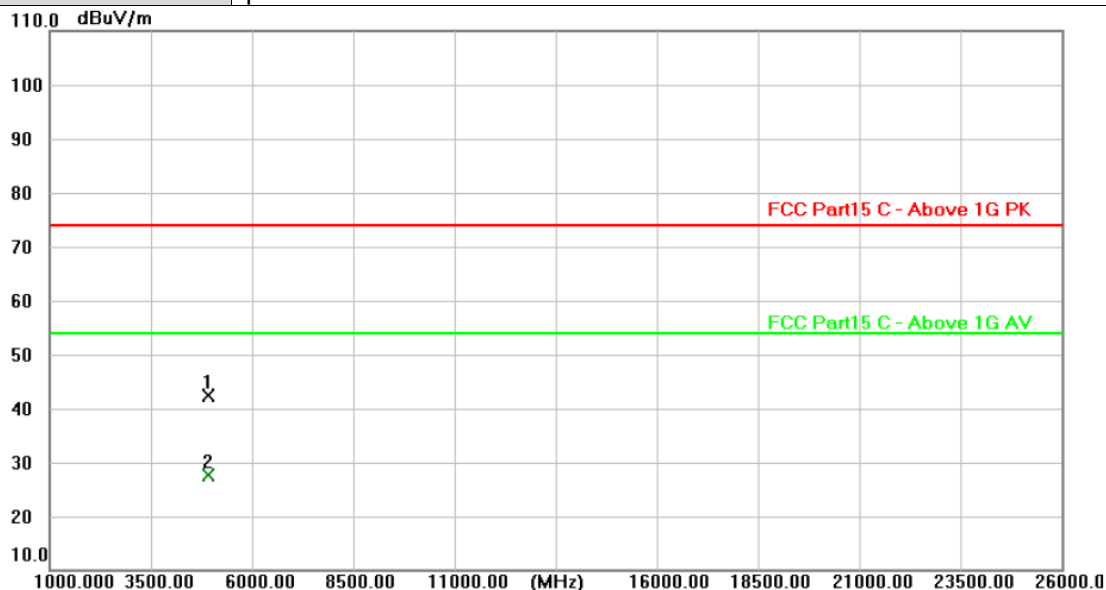

No.	Frequency (MHz)	Reading (dBuV)	Factor (dB/m)	Level (dBuV/m)	Limit (dBuV/m)	Margin (dB)	Detector
1	4903.435	40.04	2.36	42.40	74.00	-31.60	peak
2 *	4904.691	25.15	2.36	27.51	54.00	-26.49	AVG

Remarks:

- 1.Factor (dB/m) = Antenna Factor (dB/m)+Cable Factor (dB)-Pre-amplifier Factor
- 2.Margin value = Level -Limit value



Ant. Pol.	Vertical
Test Mode:	TX 802.11ax(HE40) Mode 2452MHz
Remark:	No report for the emission which more than 10 dB below the prescribed limit.

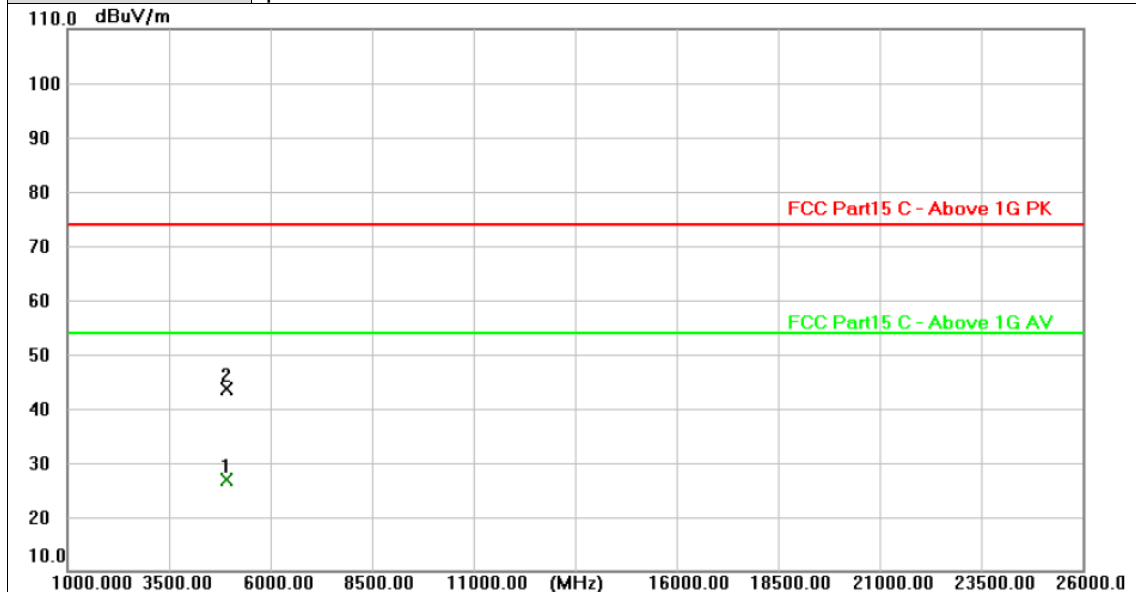

No.	Frequency (MHz)	Reading (dBuV)	Factor (dB/m)	Level (dBuV/m)	Limit (dBuV/m)	Margin (dB)	Detector
1 *	4903.877	24.51	2.36	26.87	54.00	-27.13	AVG
2	4904.050	41.38	2.36	43.74	74.00	-30.26	peak

Remarks:

- Factor (dB/m) = Antenna Factor (dB/m)+Cable Factor (dB)-Pre-amplifier Factor
- Margin value = Level -Limit value

3.3. Band Edge Emissions (Radiated)

Limit

FCC CFR Title 47 Part 15 Subpart C Section 15.247 (d)/ RSS 247 5.5:

Restricted Frequency Band (MHz)	(dBuV/m)(at 3m)	
	Peak	Average
2310 ~2390	74	54
2483.5 ~2500	74	54

Test Configuration

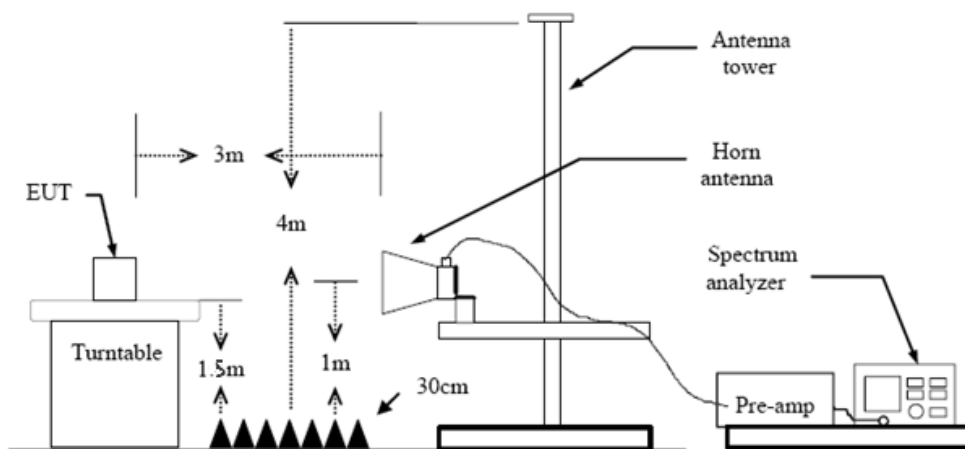

Test Procedure

1. The EUT was setup and tested according to ANSI C63.10:2013 requirements.
2. The EUT is placed on a turn table which is 1.5 meter above ground. The turn table is rotated 360 degrees to determine the position of the maximum emission level.
3. The EUT was positioned such that the distance from antenna to the EUT was 3 meters.
4. The antenna is scanned from 1 meter to 4 meters to find out the maximum emission level. This is repeated for both horizontal and vertical polarization of the antenna. In order to find the maximum emission, all of the interface cables were manipulated according to ANSI C63.10:2013 on radiated measurement.
5. The receiver set as follow:
 RBW=1MHz, VBW=3MHz Peak detector for Peak value.
 RBW=1MHz, VBW see note 1 with Peak Detector for Average Value.

Note 1: For measurements above 1 GHz the resolution bandwidth is set to 1 MHz, then the video bandwidth is set to 3 MHz for peak measurements and 1 MHz resolution bandwidth with 1/T video bandwidth with peak detector for average measurements. For the Duty Cycle please refer to clause 3.8 Duty Cycle.

Test Mode

Please refer to the clause 2.4.

Test Results



Ant. Pol.	Horizontal
Test Mode:	802.11b Mode 2412MHz

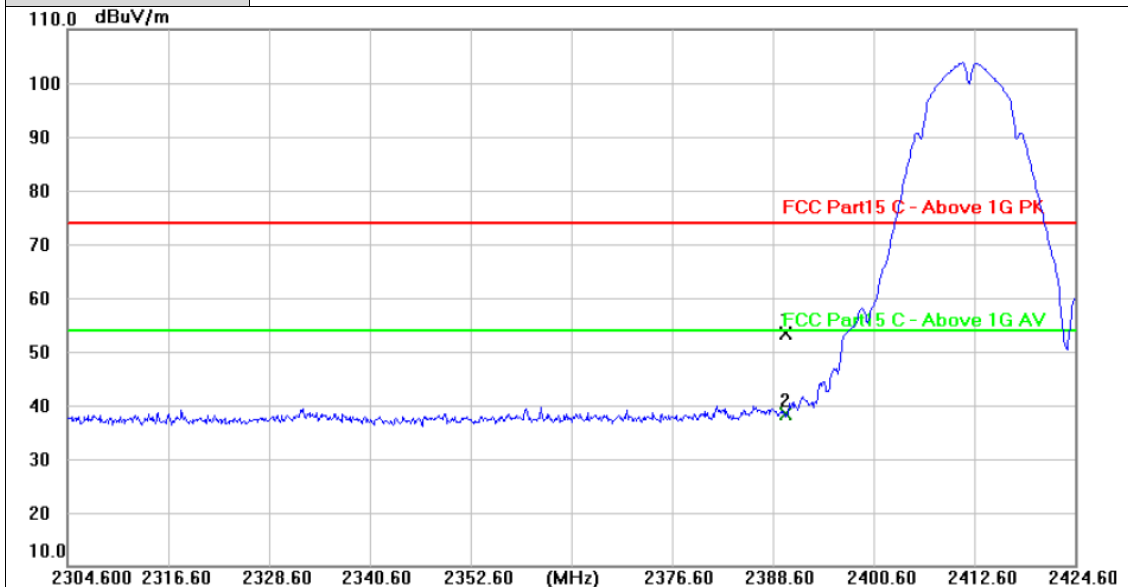

No.	Frequency (MHz)	Reading (dBuV)	Factor (dB/m)	Level (dBuV/m)	Limit (dBuV/m)	Margin (dB)	Detector
1	2390.000	22.48	30.84	53.32	74.00	-20.68	peak
2 *	2390.000	7.59	30.84	38.43	54.00	-15.57	AVG

Remarks:

- 1. Factor (dB/m) = Antenna Factor (dB/m)+Cable Factor (dB)-Pre-amplifier Factor
- 2. Margin value = Level -Limit value



Ant. Pol.	Vertical
Test Mode:	802.11b Mode 2412MHz

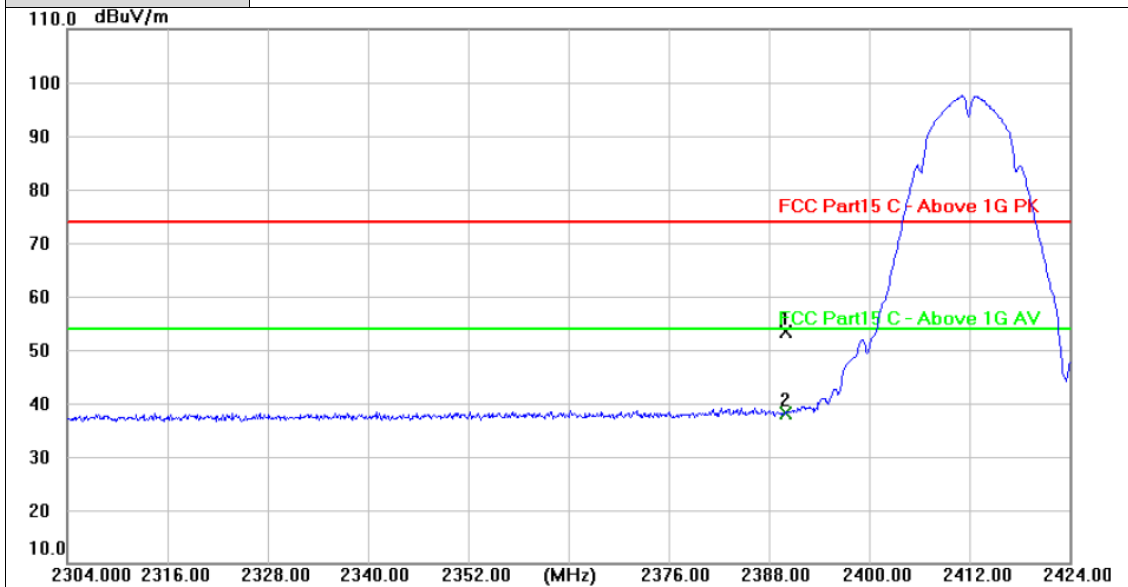

No.	Frequency (MHz)	Reading (dBuV)	Factor (dB/m)	Level (dBuV/m)	Limit (dBuV/m)	Margin (dB)	Detector
1	2390.000	22.47	30.84	53.31	74.00	-20.69	peak
2 *	2390.000	7.22	30.84	38.06	54.00	-15.94	AVG

Remarks:

- Factor (dB/m) = Antenna Factor (dB/m)+Cable Factor (dB)-Pre-amplifier Factor
- Margin value = Level -Limit value



Ant. Pol.	Horizontal
Test Mode:	802.11b Mode 2462 MHz

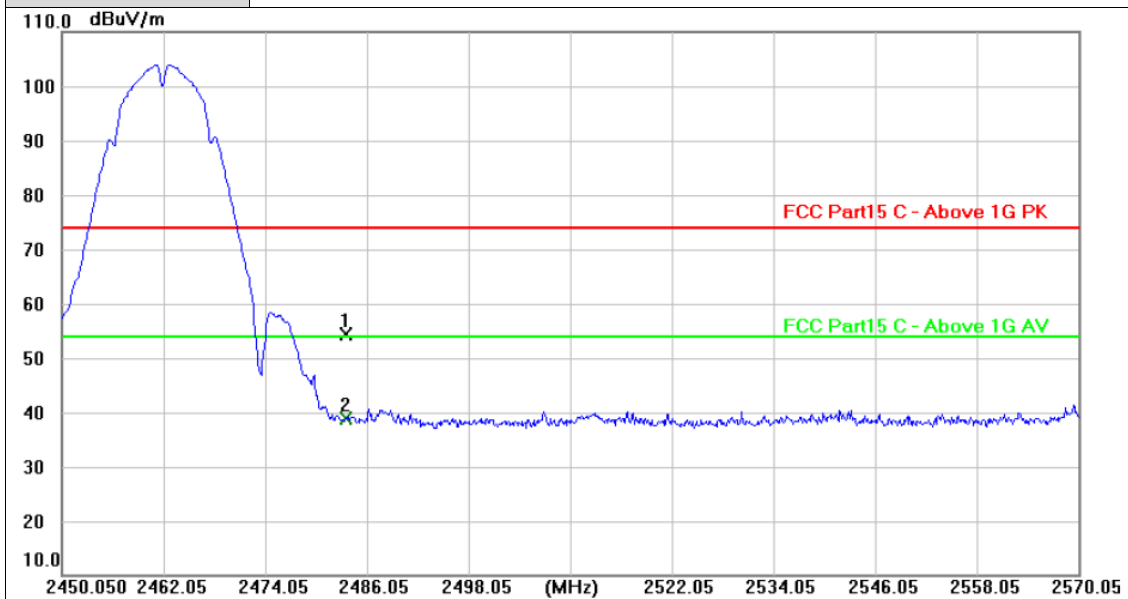

No.	Frequency (MHz)	Reading (dBuV)	Factor (dB/m)	Level (dBuV/m)	Limit (dBuV/m)	Margin (dB)	Detector
1	2483.500	23.24	31.24	54.48	74.00	-19.52	peak
2 *	2483.500	7.54	31.24	38.78	54.00	-15.22	AVG

Remarks:

- 1. Factor (dB/m) = Antenna Factor (dB/m)+Cable Factor (dB)-Pre-amplifier Factor
- 2. Margin value = Level -Limit value

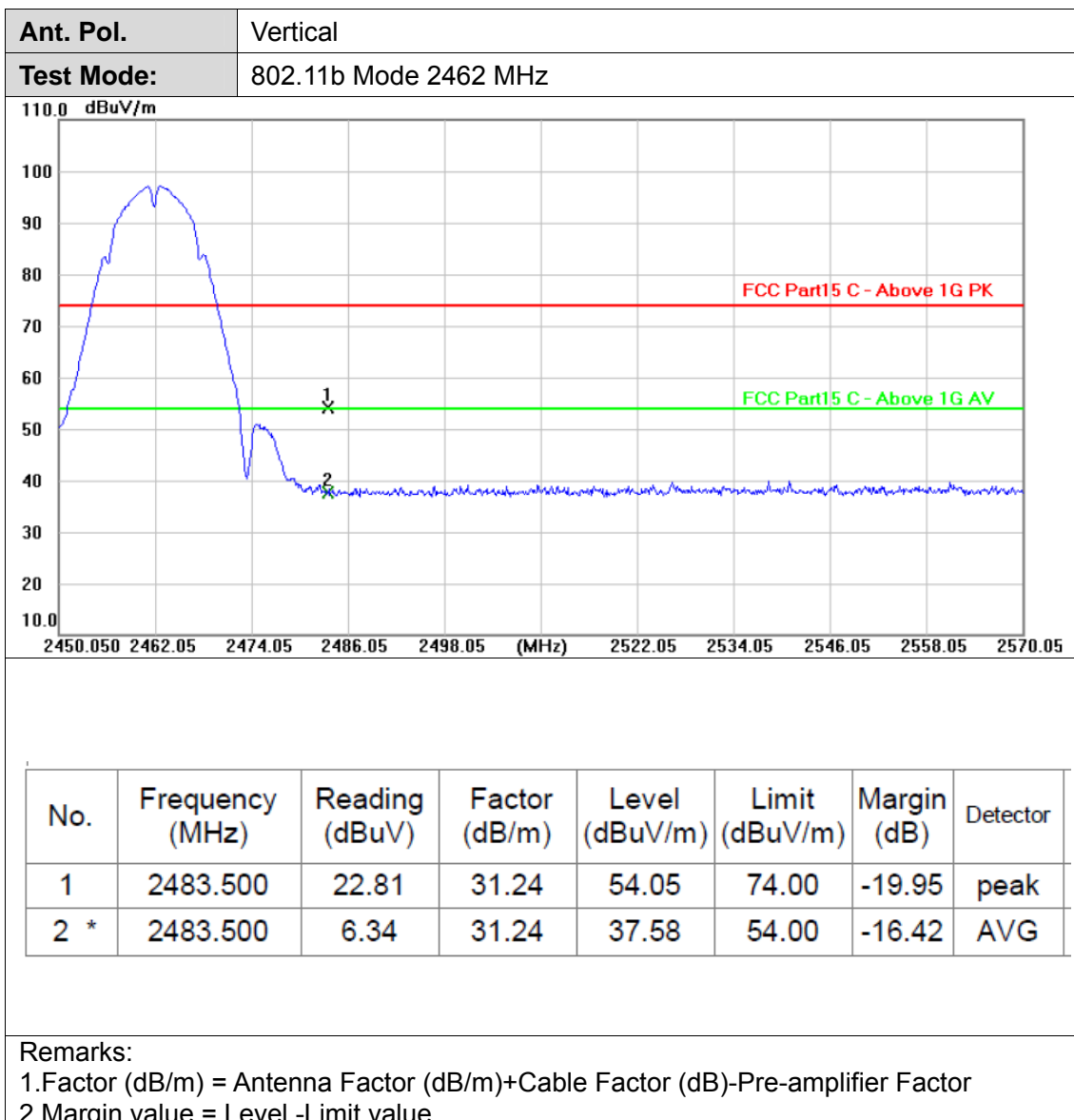

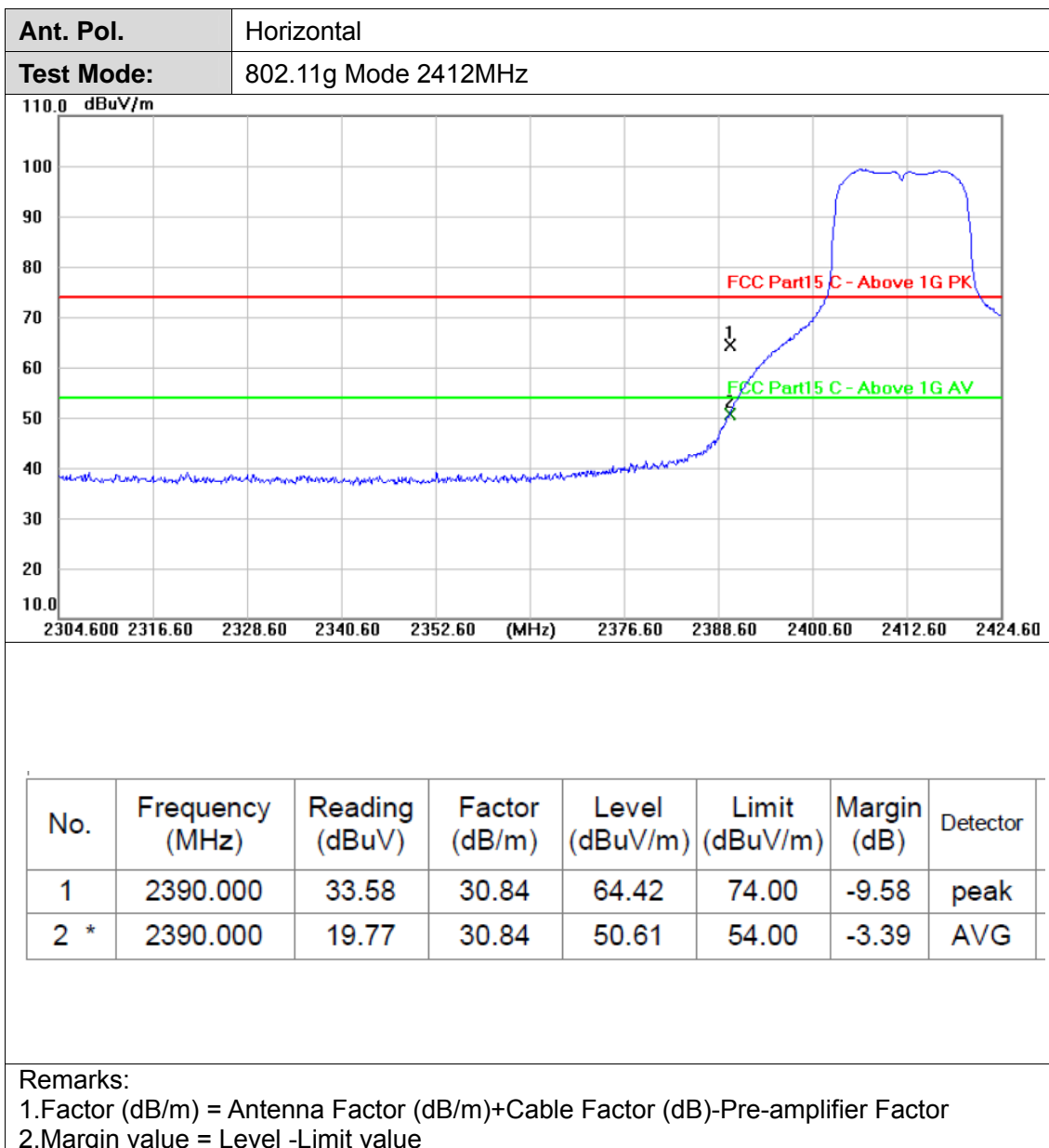

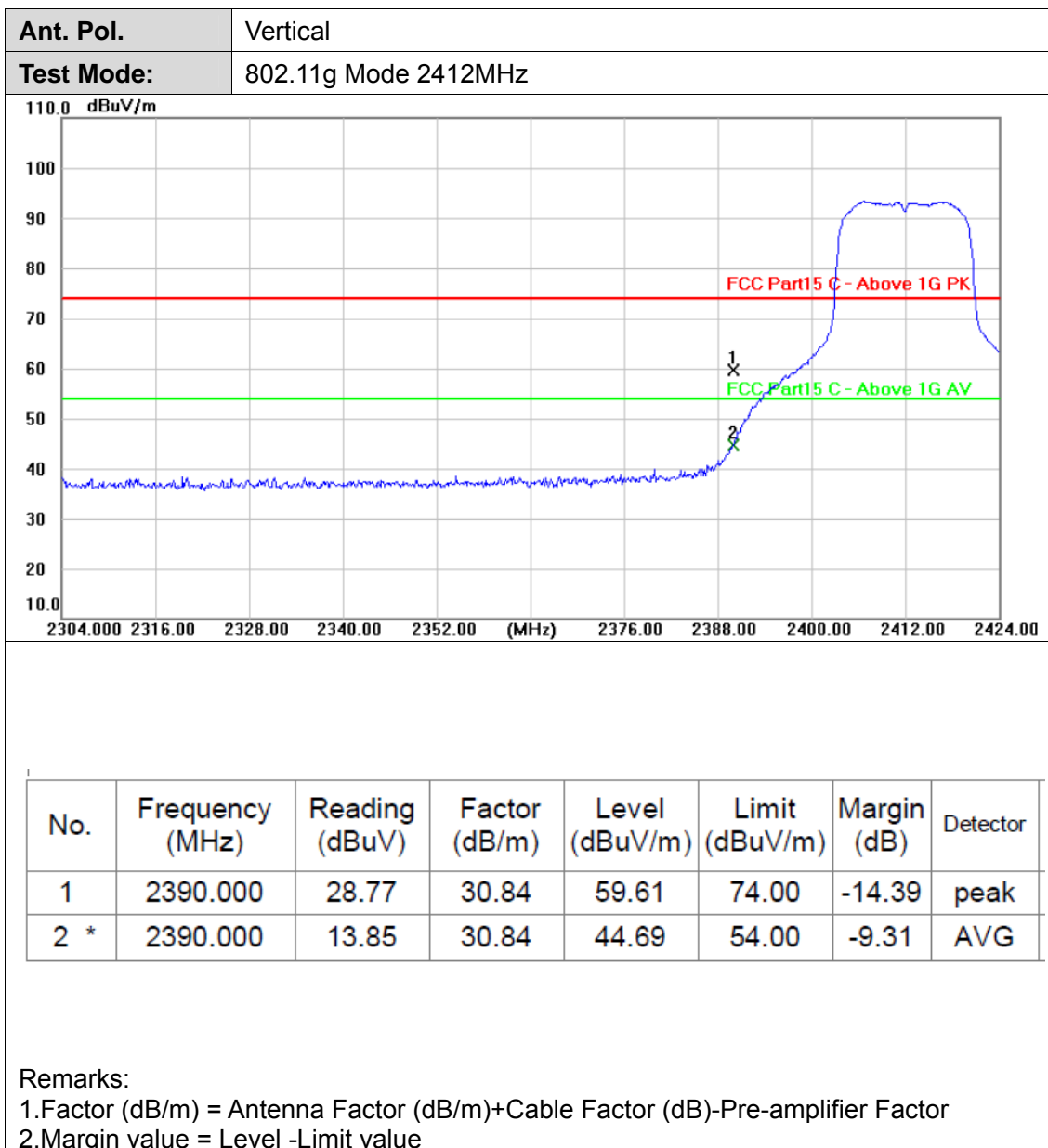



Ant. Pol.	Horizontal
Test Mode:	802.11g Mode 2462MHz

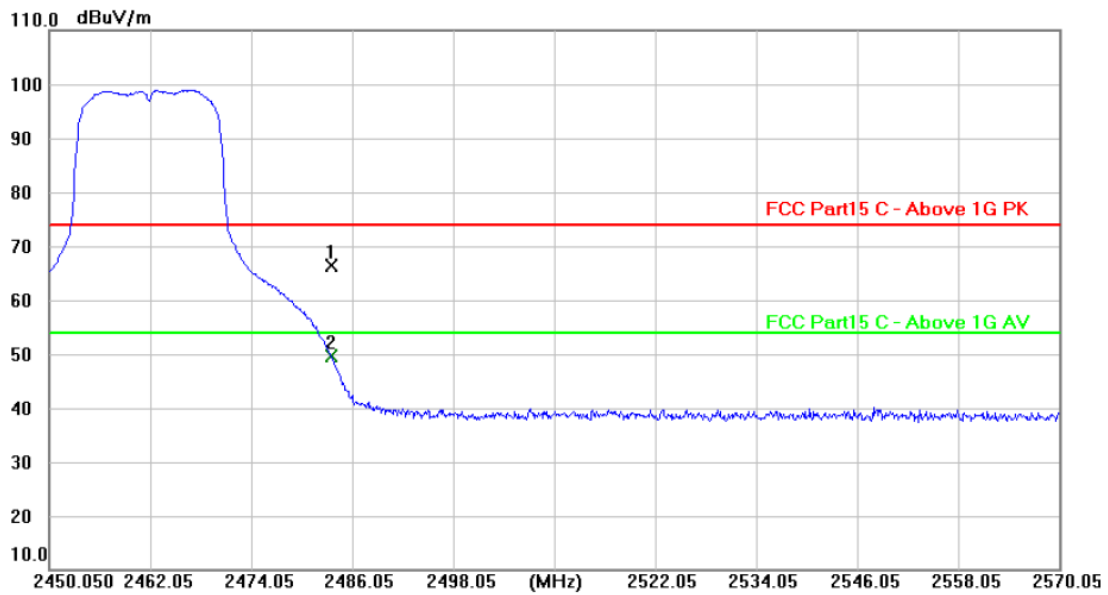

No.	Frequency (MHz)	Reading (dBuV)	Factor (dB/m)	Level (dBuV/m)	Limit (dBuV/m)	Margin (dB)	Detector
1	2483.500	35.02	31.24	66.26	74.00	-7.74	peak
2 *	2483.500	18.48	31.24	49.72	54.00	-4.28	AVG

Remarks:

- 1. Factor (dB/m) = Antenna Factor (dB/m)+Cable Factor (dB)-Pre-amplifier Factor
- 2. Margin value = Level -Limit value



Ant. Pol.	Vertical
Test Mode:	802.11g Mode 2462MHz

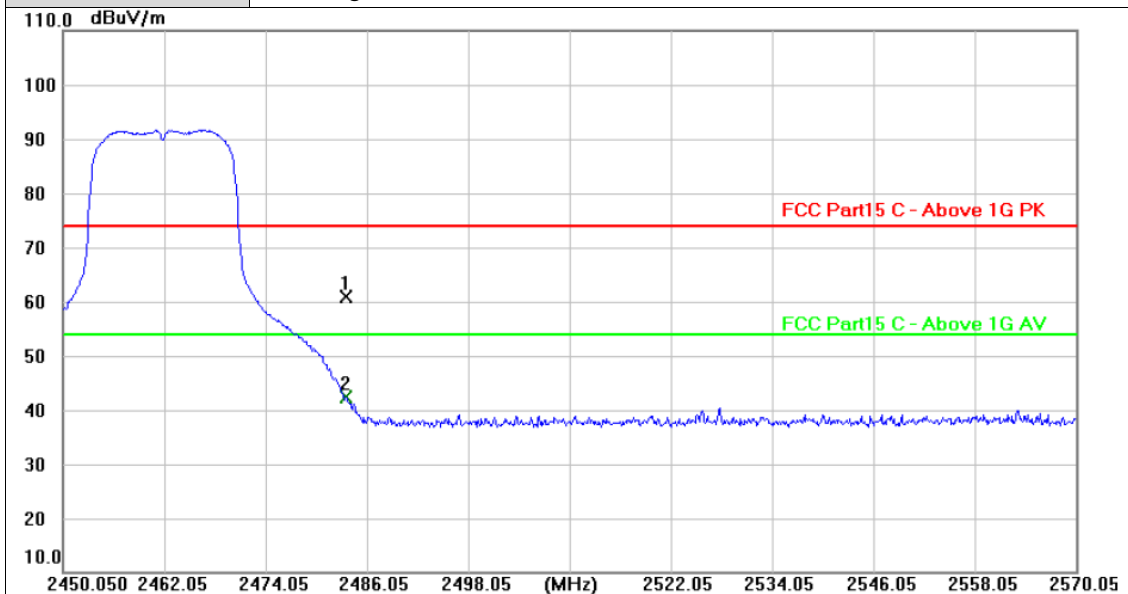

No.	Frequency (MHz)	Reading (dBuV)	Factor (dB/m)	Level (dBuV/m)	Limit (dBuV/m)	Margin (dB)	Detector
1	2483.500	29.61	31.24	60.85	74.00	-13.15	peak
2 *	2483.500	11.09	31.24	42.33	54.00	-11.67	AVG

Remarks:

- 1. Factor (dB/m) = Antenna Factor (dB/m)+Cable Factor (dB)-Pre-amplifier Factor
- 2. Margin value = Level -Limit value



Ant. Pol.	Horizontal
Test Mode:	802.11n(HT20) Mode 2412MHz

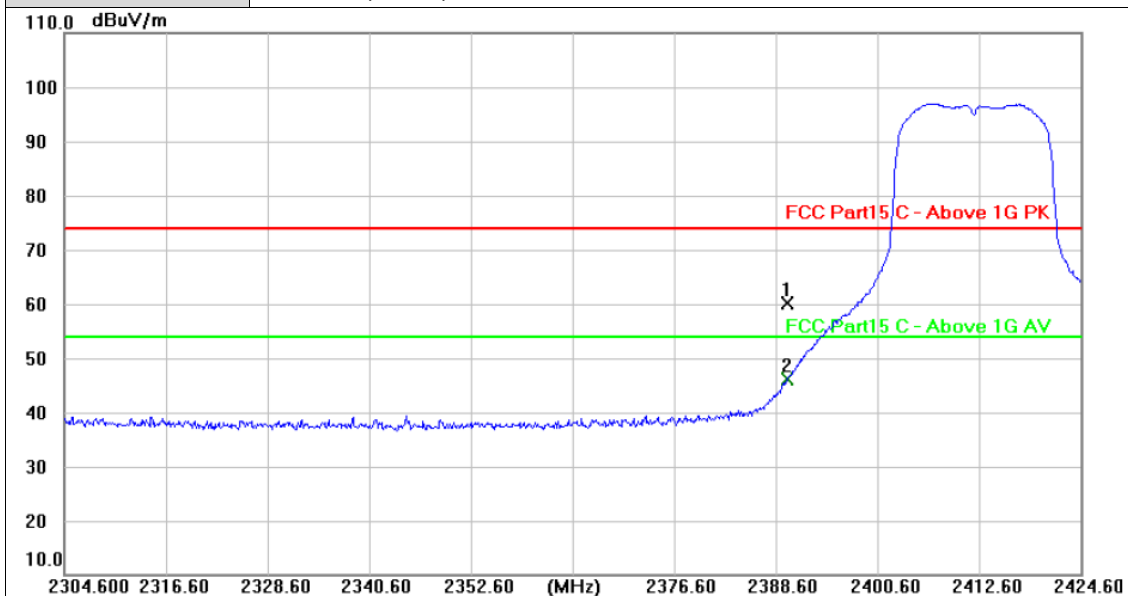

No.	Frequency (MHz)	Reading (dBuV)	Factor (dB/m)	Level (dBuV/m)	Limit (dBuV/m)	Margin (dB)	Detector
1	2390.000	29.24	30.84	60.08	74.00	-13.92	peak
2 *	2390.000	15.24	30.84	46.08	54.00	-7.92	AVG

Remarks:

- 1. Factor (dB/m) = Antenna Factor (dB/m)+Cable Factor (dB)-Pre-amplifier Factor
- 2. Margin value = Level -Limit value



Ant. Pol.	Vertical
Test Mode:	802.11n(HT20) Mode 2412MHz

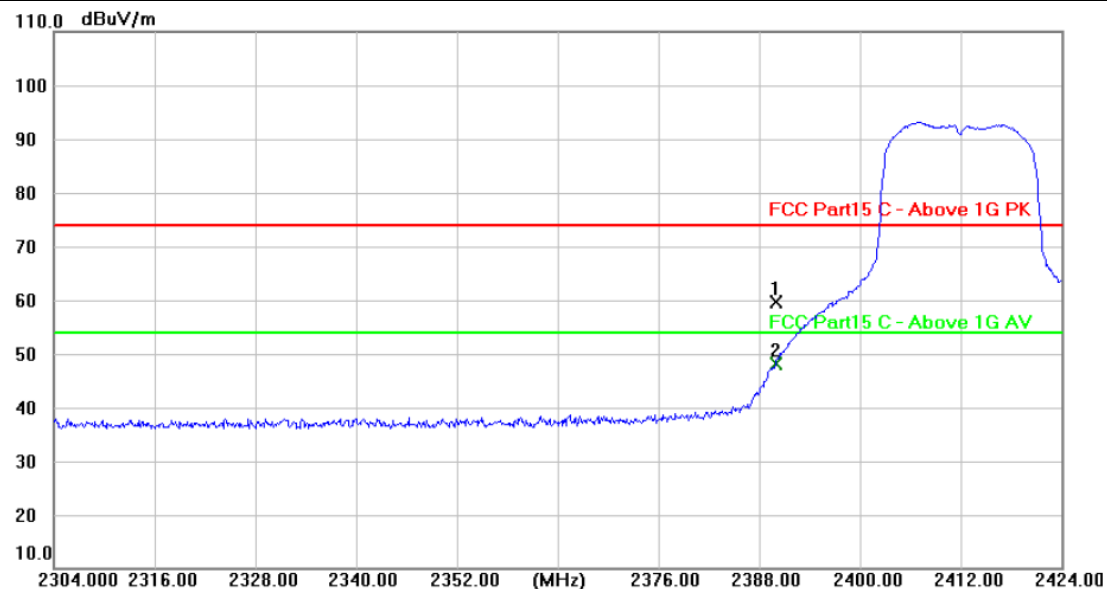

No.	Frequency (MHz)	Reading (dBuV)	Factor (dB/m)	Level (dBuV/m)	Limit (dBuV/m)	Margin (dB)	Detector
1	2390.000	28.72	30.84	59.56	74.00	-14.44	peak
2 *	2390.000	17.23	30.84	48.07	54.00	-5.93	AVG

Remarks:

- 1. Factor (dB/m) = Antenna Factor (dB/m)+Cable Factor (dB)-Pre-amplifier Factor
- 2. Margin value = Level -Limit value



Ant. Pol.	Horizontal
Test Mode:	802.11n(HT20) Mode 2462MHz

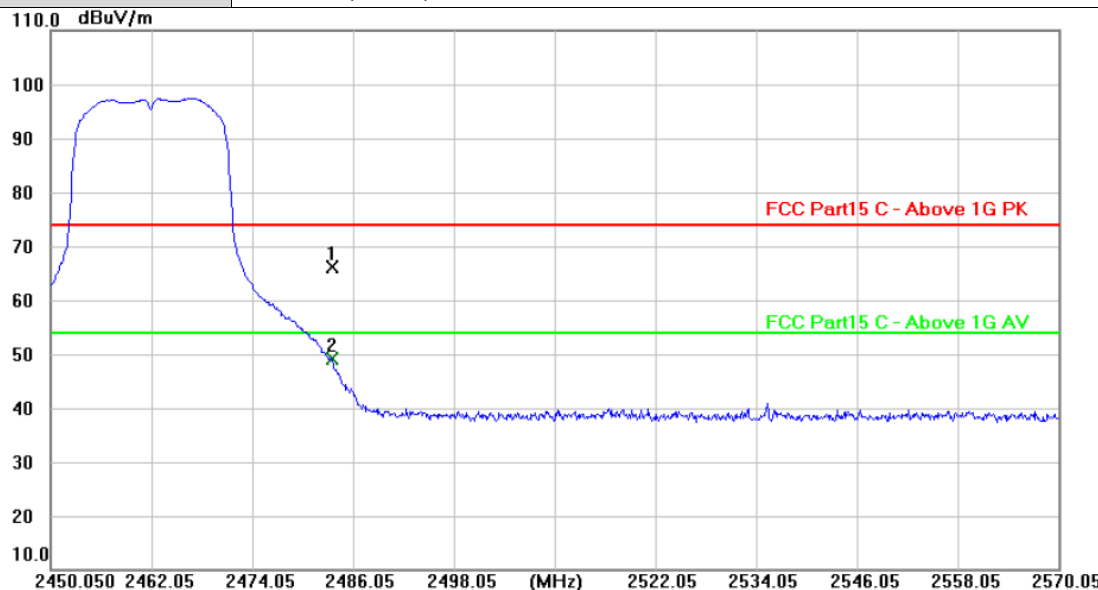

No.	Frequency (MHz)	Reading (dBuV)	Factor (dB/m)	Level (dBuV/m)	Limit (dBuV/m)	Margin (dB)	Detector
1	2483.500	34.89	31.24	66.13	74.00	-7.87	peak
2 *	2483.500	17.82	31.24	49.06	54.00	-4.94	AVG

Remarks:

1. Factor (dB/m) = Antenna Factor (dB/m)+Cable Factor (dB)-Pre-amplifier Factor
2. Margin value = Level -Limit value



Ant. Pol.	Vertical
Test Mode:	802.11n(HT20) Mode 2462MHz

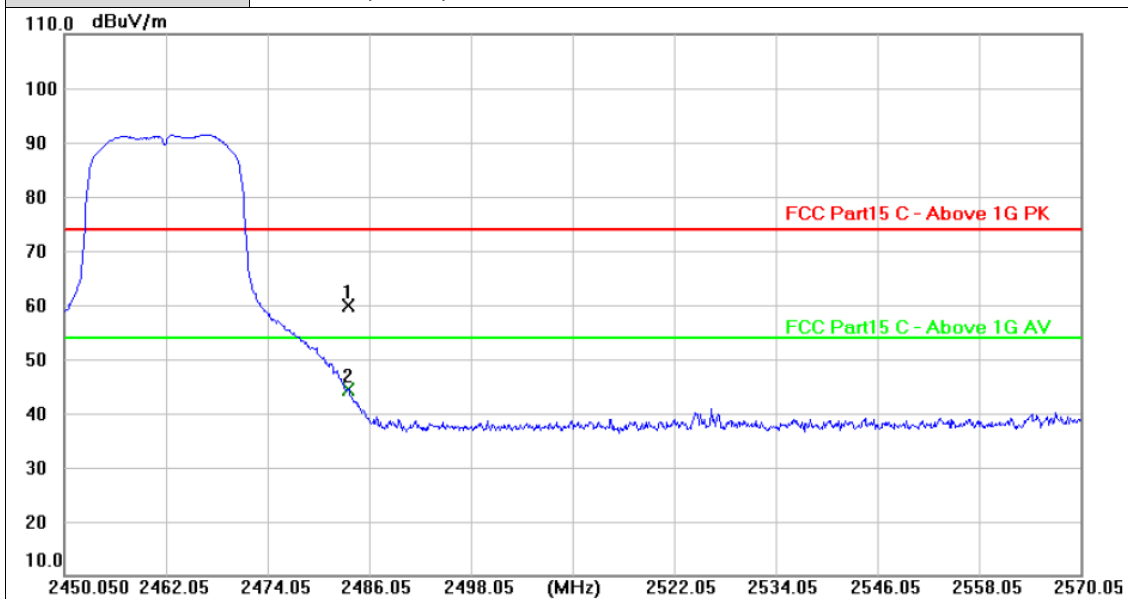

No.	Frequency (MHz)	Reading (dBuV)	Factor (dB/m)	Level (dBuV/m)	Limit (dBuV/m)	Margin (dB)	Detector
1	2483.500	28.76	31.24	60.00	74.00	-14.00	peak
2 *	2483.500	13.14	31.24	44.38	54.00	-9.62	AVG

Remarks:

- 1. Factor (dB/m) = Antenna Factor (dB/m)+Cable Factor (dB)-Pre-amplifier Factor
- 2. Margin value = Level -Limit value



Ant. Pol.	Horizontal
Test Mode:	802.11n(HT40) Mode 2422MHz

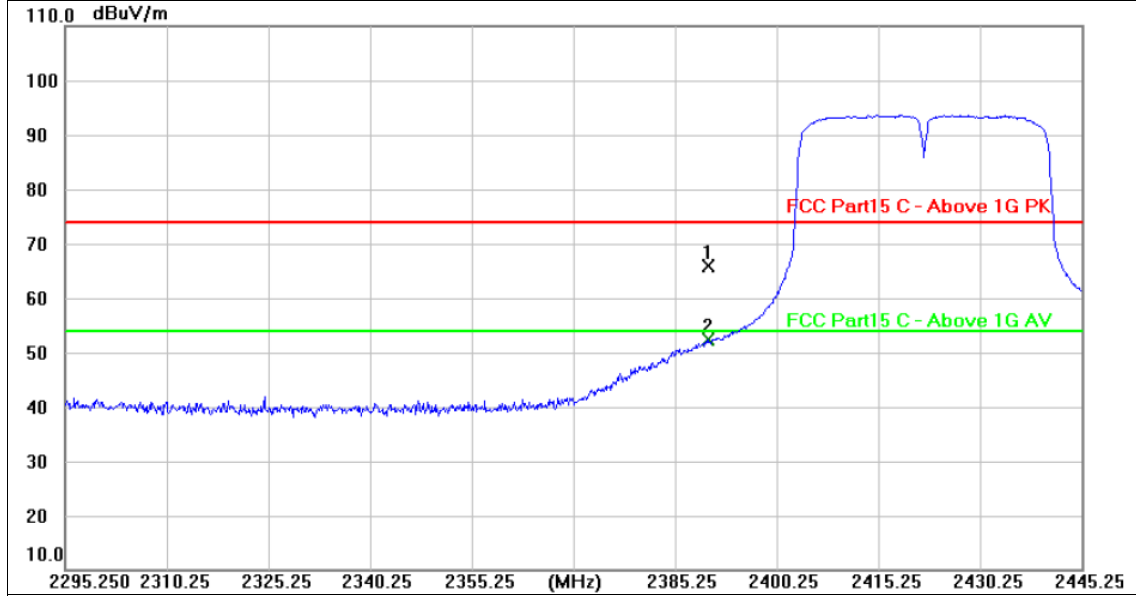

No.	Frequency (MHz)	Reading (dBuV)	Factor (dB/m)	Level (dBuV/m)	Limit (dBuV/m)	Margin (dB)	Detector
1	2390.000	35.02	30.84	65.86	74.00	-8.14	peak
2 *	2390.000	21.56	30.84	52.40	54.00	-1.60	AVG

Remarks:

- 1. Factor (dB/m) = Antenna Factor (dB/m)+Cable Factor (dB)-Pre-amplifier Factor
- 2. Margin value = Level -Limit value



Ant. Pol.	Vertical
Test Mode:	802.11n(HT40) Mode 2422MHz

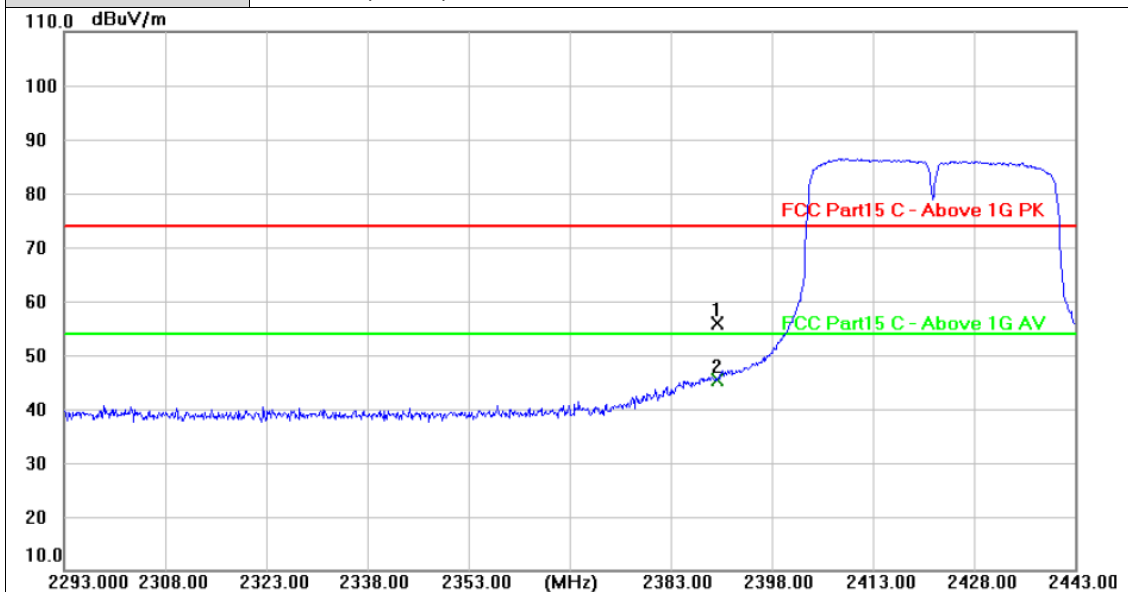

No.	Frequency (MHz)	Reading (dBuV)	Factor (dB/m)	Level (dBuV/m)	Limit (dBuV/m)	Margin (dB)	Detector
1	2390.000	25.07	30.84	55.91	74.00	-18.09	peak
2 *	2390.000	14.45	30.84	45.29	54.00	-8.71	AVG

Remarks:

- 1. Factor (dB/m) = Antenna Factor (dB/m)+Cable Factor (dB)-Pre-amplifier Factor
- 2. Margin value = Level -Limit value



Ant. Pol.	Horizontal
Test Mode:	802.11n(HT40) Mode 2452MHz

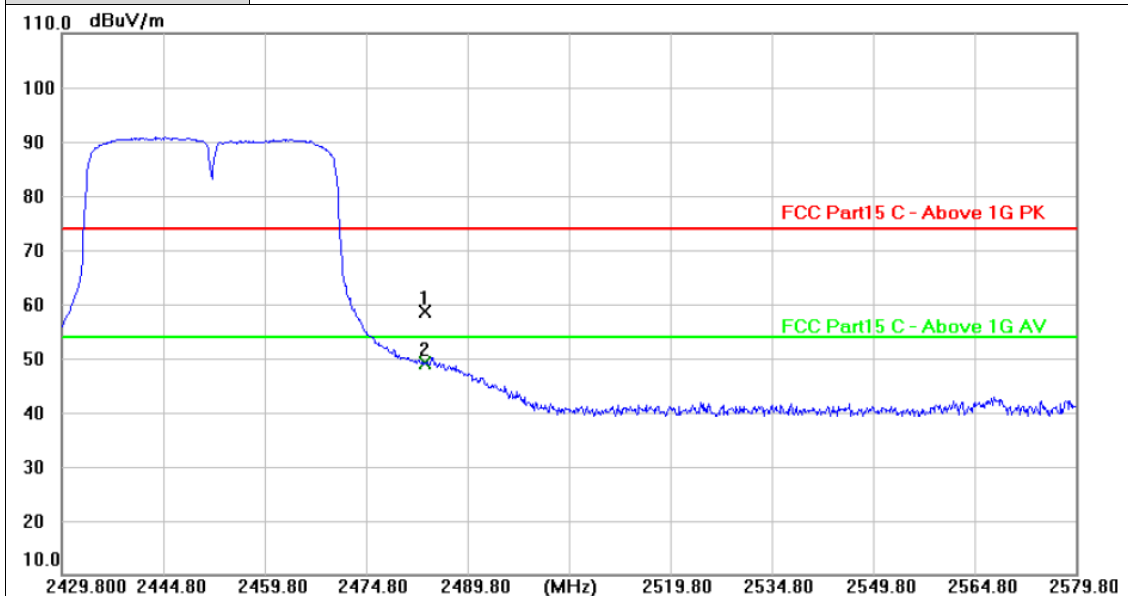

No.	Frequency (MHz)	Reading (dBuV)	Factor (dB/m)	Level (dBuV/m)	Limit (dBuV/m)	Margin (dB)	Detector
1	2483.500	27.38	31.24	58.62	74.00	-15.38	peak
2 *	2483.500	17.91	31.24	49.15	54.00	-4.85	AVG

Remarks:

- 1. Factor (dB/m) = Antenna Factor (dB/m)+Cable Factor (dB)-Pre-amplifier Factor
- 2. Margin value = Level -Limit value



Ant. Pol.	Vertical
Test Mode:	802.11n(HT40) Mode 2452MHz

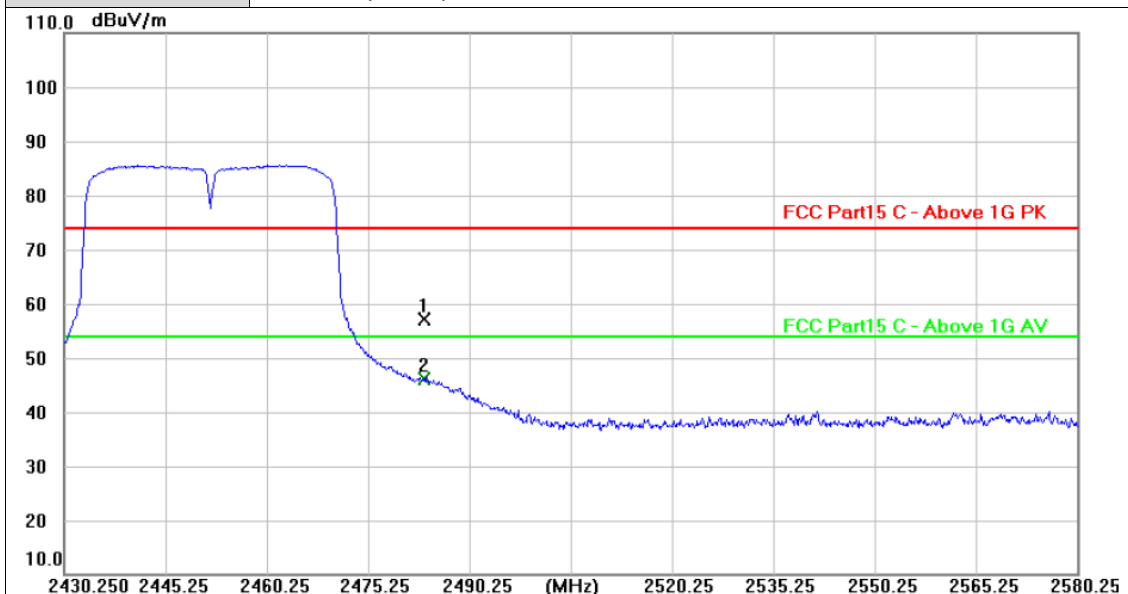

No.	Frequency (MHz)	Reading (dBuV)	Factor (dB/m)	Level (dBuV/m)	Limit (dBuV/m)	Margin (dB)	Detector
1	2483.500	25.81	31.24	57.05	74.00	-16.95	peak
2 *	2483.500	14.99	31.24	46.23	54.00	-7.77	AVG

Remarks:

- 1. Factor (dB/m) = Antenna Factor (dB/m)+Cable Factor (dB)-Pre-amplifier Factor
- 2. Margin value = Level -Limit value



Ant. Pol.	Horizontal
Test Mode:	TX 802.11ax(HE20) Mode 2412MHz

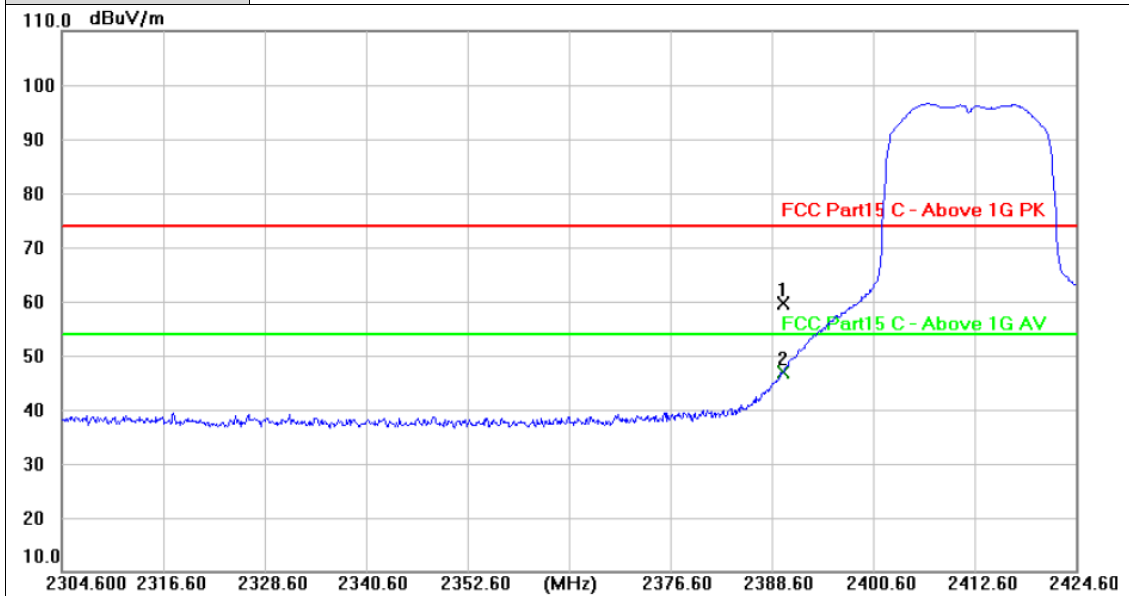

No.	Frequency (MHz)	Reading (dBuV)	Factor (dB/m)	Level (dBuV/m)	Limit (dBuV/m)	Margin (dB)	Detector
1	2390.000	28.67	30.84	59.51	74.00	-14.49	peak
2 *	2390.000	16.03	30.84	46.87	54.00	-7.13	AVG

Remarks:

- 1. Factor (dB/m) = Antenna Factor (dB/m)+Cable Factor (dB)-Pre-amplifier Factor
- 2. Margin value = Level -Limit value



Ant. Pol.	Vertical
Test Mode:	TX 802.11ax(HE20) Mode 2412MHz

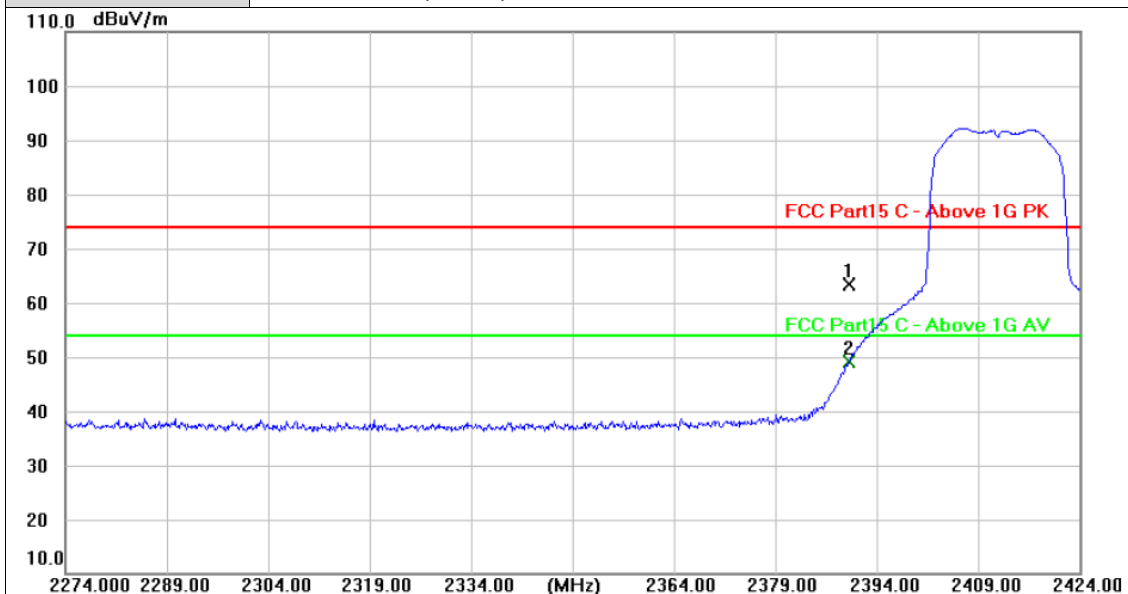

No.	Frequency (MHz)	Reading (dBuV)	Factor (dB/m)	Level (dBuV/m)	Limit (dBuV/m)	Margin (dB)	Detector
1	2390.000	32.43	30.84	63.27	74.00	-10.73	peak
2 *	2390.000	18.24	30.84	49.08	54.00	-4.92	AVG

Remarks:

- 1.Factor (dB/m) = Antenna Factor (dB/m)+Cable Factor (dB)-Pre-amplifier Factor
- 2.Margin value = Level -Limit value



Ant. Pol.	Horizontal
Test Mode:	TX 802.11ax(HE20) Mode 2462MHz

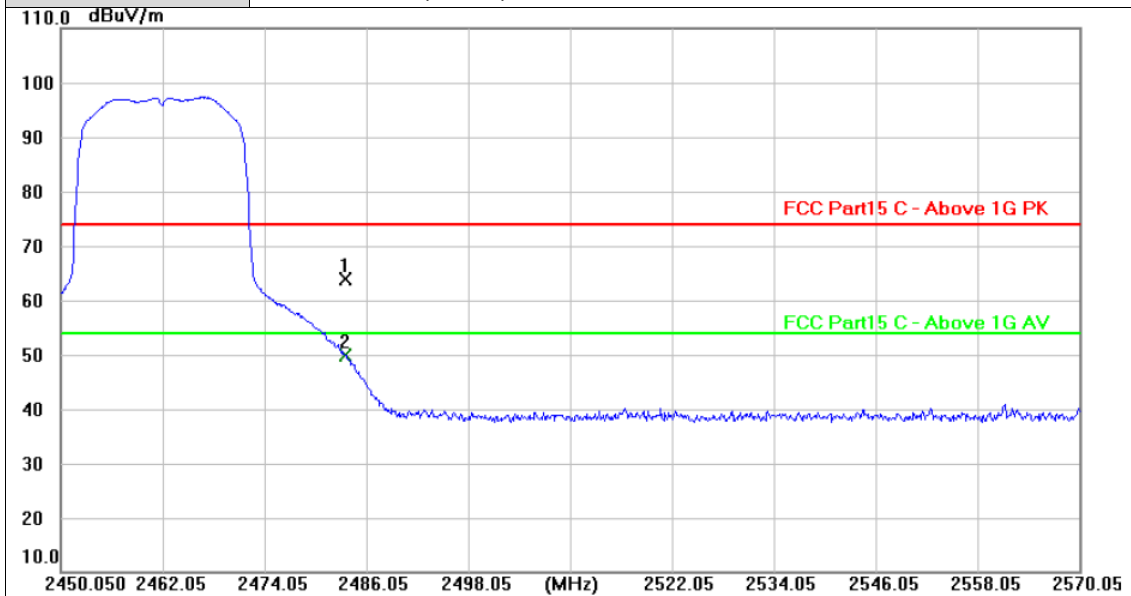

No.	Frequency (MHz)	Reading (dBuV)	Factor (dB/m)	Level (dBuV/m)	Limit (dBuV/m)	Margin (dB)	Detector
1	2483.500	32.57	31.24	63.81	74.00	-10.19	peak
2 *	2483.500	18.63	31.24	49.87	54.00	-4.13	AVG

Remarks:

- 1. Factor (dB/m) = Antenna Factor (dB/m)+Cable Factor (dB)-Pre-amplifier Factor
- 2. Margin value = Level -Limit value



Ant. Pol.	Vertical
Test Mode:	TX 802.11ax(HE20) Mode 2462MHz

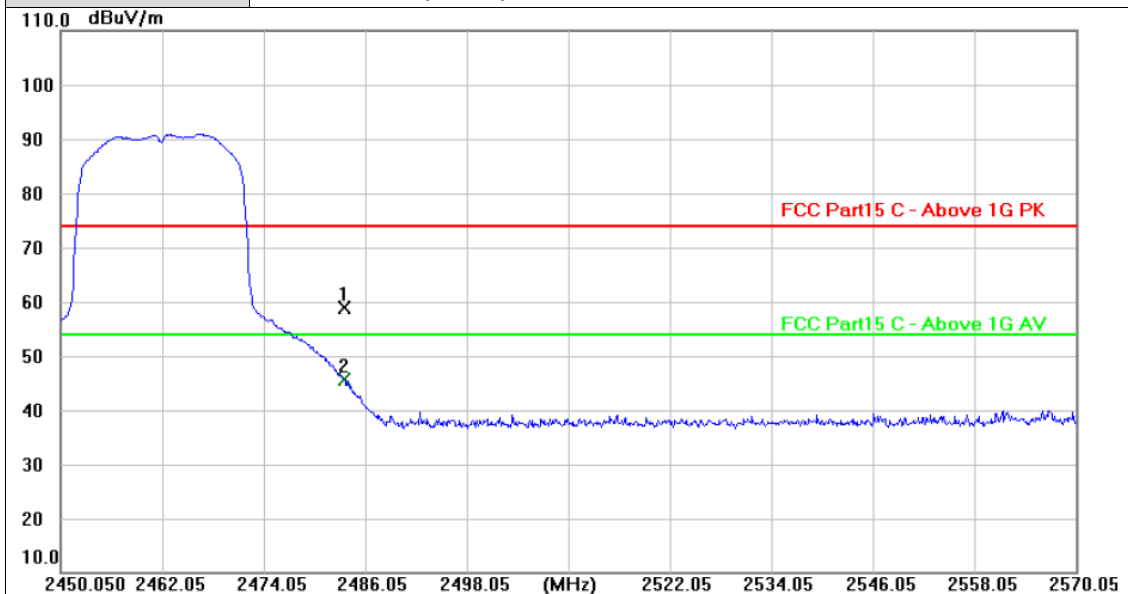

No.	Frequency (MHz)	Reading (dBuV)	Factor (dB/m)	Level (dBuV/m)	Limit (dBuV/m)	Margin (dB)	Detector
1	2483.500	27.55	31.24	58.79	74.00	-15.21	peak
2 *	2483.500	14.38	31.24	45.62	54.00	-8.38	AVG

Remarks:

- 1.Factor (dB/m) = Antenna Factor (dB/m)+Cable Factor (dB)-Pre-amplifier Factor
- 2.Margin value = Level -Limit value



Ant. Pol.	Horizontal
Test Mode:	TX 802.11ax(HE40) Mode 2422MHz

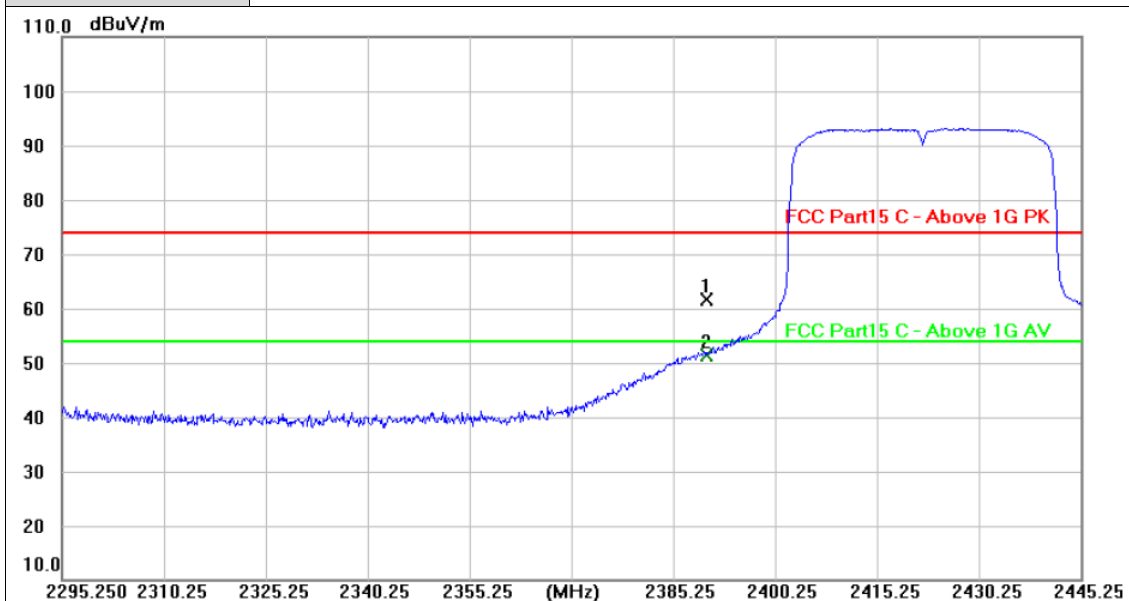

No.	Frequency (MHz)	Reading (dBuV)	Factor (dB/m)	Level (dBuV/m)	Limit (dBuV/m)	Margin (dB)	Detector
1	2390.000	30.90	30.84	61.74	74.00	-12.26	peak
2 *	2390.000	20.43	30.84	51.27	54.00	-2.73	AVG

Remarks:

- 1. Factor (dB/m) = Antenna Factor (dB/m)+Cable Factor (dB)-Pre-amplifier Factor
- 2. Margin value = Level -Limit value



Ant. Pol.	Vertical
Test Mode:	TX 802.11ax(HE40) Mode 2422MHz

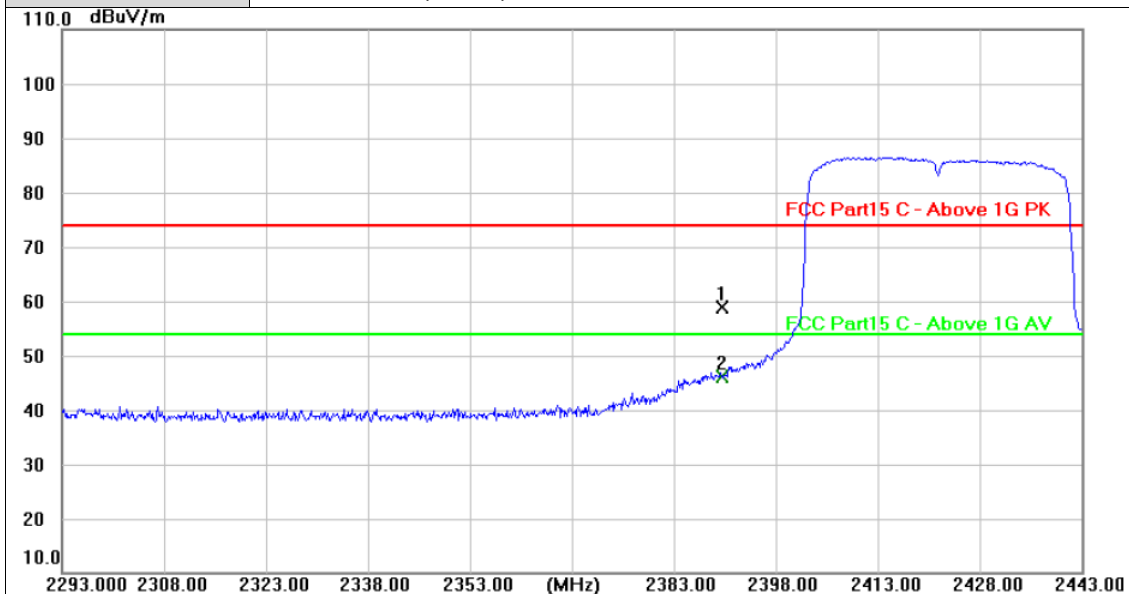

No.	Frequency (MHz)	Reading (dBuV)	Factor (dB/m)	Level (dBuV/m)	Limit (dBuV/m)	Margin (dB)	Detector
1	2390.000	28.10	30.84	58.94	74.00	-15.06	peak
2 *	2390.000	15.38	30.84	46.22	54.00	-7.78	AVG

Remarks:

- 1. Factor (dB/m) = Antenna Factor (dB/m)+Cable Factor (dB)-Pre-amplifier Factor
- 2. Margin value = Level -Limit value



Ant. Pol.	Horizontal
Test Mode:	TX 802.11ax(HE40) Mode 2452MHz

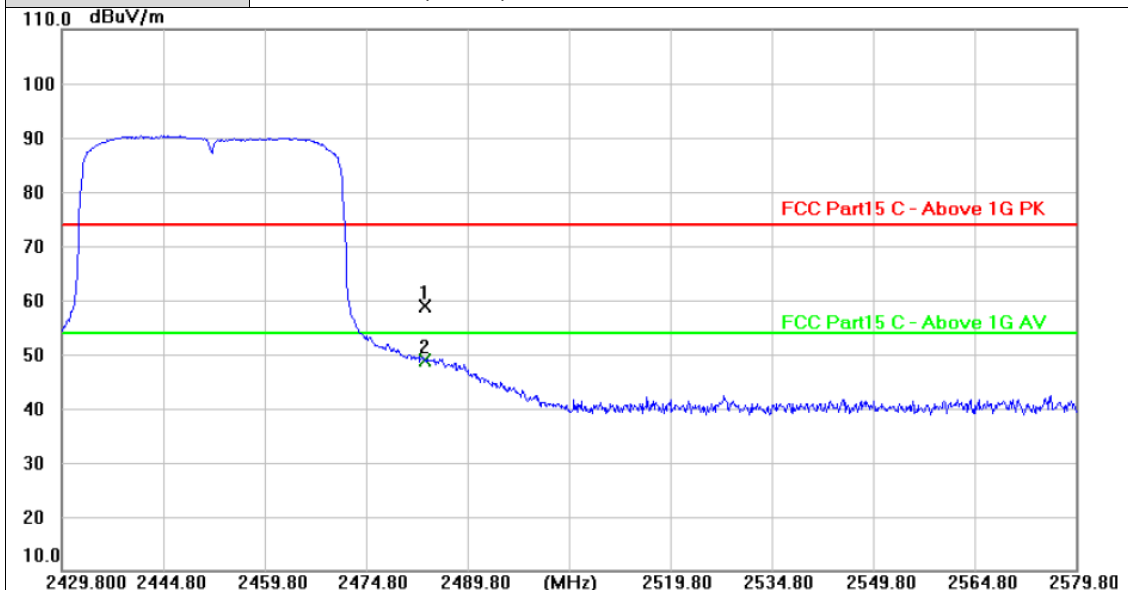

No.	Frequency (MHz)	Reading (dBuV)	Factor (dB/m)	Level (dBuV/m)	Limit (dBuV/m)	Margin (dB)	Detector
1	2483.500	27.68	31.24	58.92	74.00	-15.08	peak
2 *	2483.500	17.67	31.24	48.91	54.00	-5.09	AVG

Remarks:

- 1. Factor (dB/m) = Antenna Factor (dB/m)+Cable Factor (dB)-Pre-amplifier Factor
- 2. Margin value = Level -Limit value



Ant. Pol.	Vertical
Test Mode:	TX 802.11ax(HE40) Mode 2452MHz

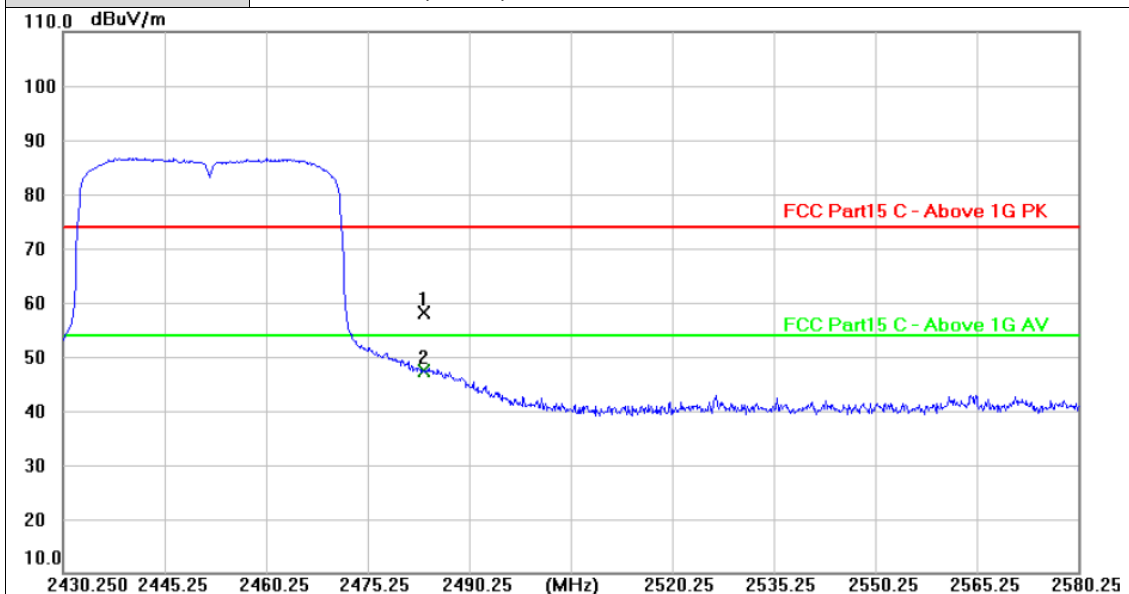

No.	Frequency (MHz)	Reading (dBuV)	Factor (dB/m)	Level (dBuV/m)	Limit (dBuV/m)	Margin (dB)	Detector
1	2483.500	26.88	31.24	58.12	74.00	-15.88	peak
2 *	2483.500	16.04	31.24	47.28	54.00	-6.72	AVG

Remarks:

- 1.Factor (dB/m) = Antenna Factor (dB/m)+Cable Factor (dB)-Pre-amplifier Factor
- 2.Margin value = Level -Limit value



3.4. Band edge and Spurious Emissions (Conducted)

Limit

FCC CFR Title 47 Part 15 Subpart C Section 15.247 (d): In any 100 kHz bandwidth outside the frequency band in which the spread spectrum intentional radiator is operating, the radio frequency power that is produced by the intentional radiator shall be at least 30 dB below that in the 100 kHz bandwidth within the band that contains the highest level of the desired power, based on either an RF conducted or a radiated measurement.

Test Configuration

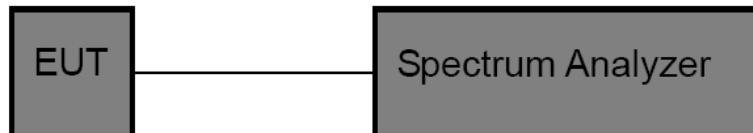

Test Procedure

1. The transmitter output was connected to the spectrum analyzer through an attenuator, the path loss was compensated to the results for each measurement.
2. Set to the maximum power setting and enable the EUT transmit continuously
3. Use the following spectrum analyzer settings:
RBW = 100 kHz, VBW \geq RBW, scan up through 10th harmonic.
Sweep = auto, Detector function = peak, Trace = max hold
4. Measure and record the results in the test report.

Test Mode

Please refer to the clause 2.4.

Test Results

**(1) Band edge Conducted Test**

Test Mode	Test Frequency	Ref Level[dBm]	Result[dBm]	Limit[dBm]	Verdict
802.11b	2412	10.43	-37.84	≤ -19.57	PASS
	2462	10.56	-51.09	≤ -19.44	PASS
802.11g	2412	4.01	-31.61	≤ -25.99	PASS
	2462	2.13	-46.11	≤ -27.87	PASS
802.11n(HT20)	2412	1.27	-31.42	≤ -28.73	PASS
	2462	4.35	-43.72	≤ -25.65	PASS
802.11n(HT40)	2422	-0.14	-34.87	≤ -30.14	PASS
	2452	0.41	-39.03	≤ -29.59	PASS
802.11ax(HE20)	2412	4.15	-32.66	≤ -25.85	PASS
	2462	3.06	-43.66	≤ -26.94	PASS
802.11ax(HE40)	2422	0.67	-34.93	≤ -29.33	PASS
	2452	-0.01	-37.85	≤ -30.01	PASS



802.11b_Low_2412

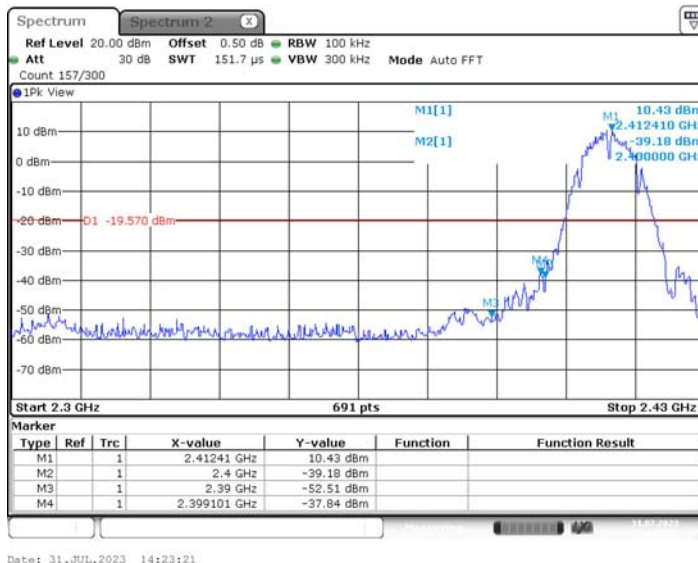

802.11b_High_2462

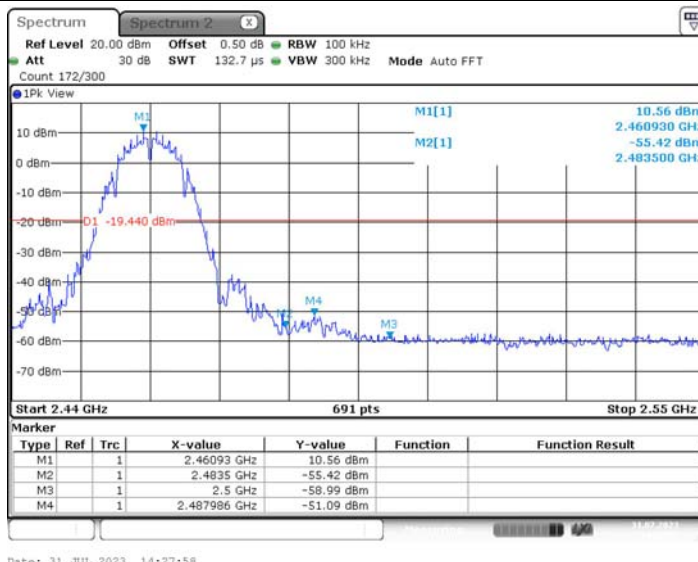

802.11g_Low_2412

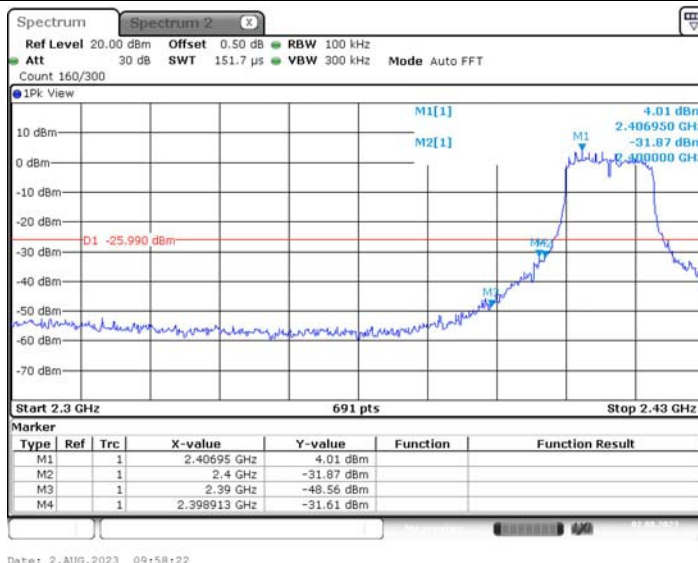

CTC Laboratories, Inc.

1-2/F., Building 2, Jiaquan Building, Guanlan High-Tech Park, Shenzhen, Guangdong, China
Tel.: (86)755-27521059 Fax: (86)755-27521011 Http://www.sz-ctc.org.cn



For anti-fake verification, please visit the official website of Certification and Accreditation Administration of the People's Republic of China : yz.cnca.cn



802.11g_High_2462

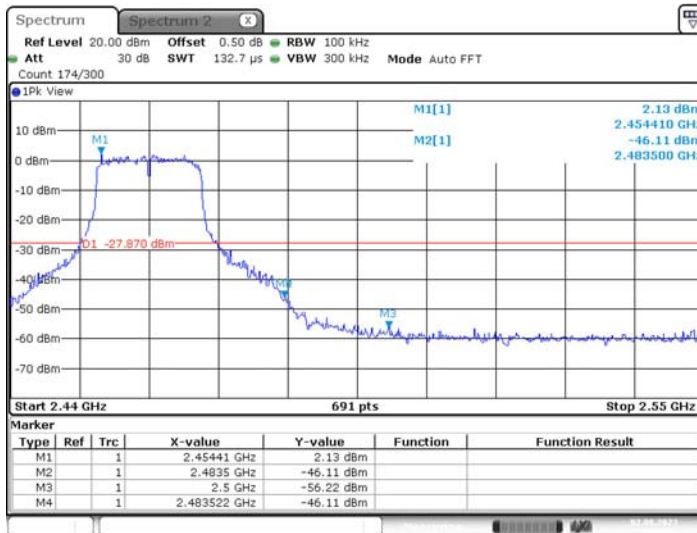

Date: 2.AUG.2023 10:08:38

802.11n(HT20)_Low_2412

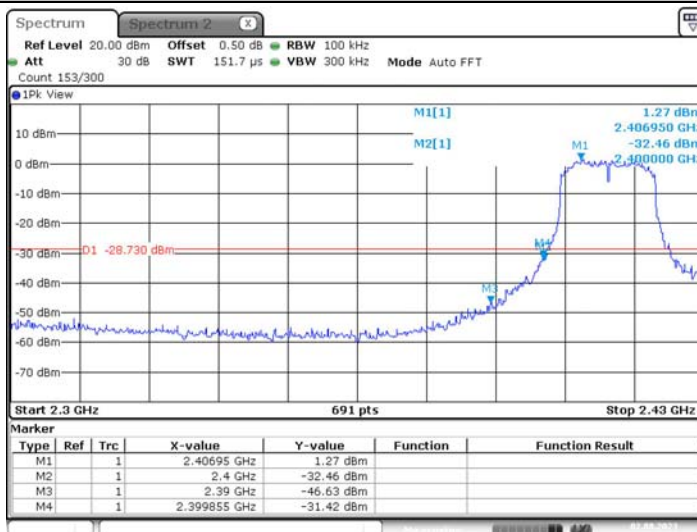

Date: 2.AUG.2023 10:11:50

802.11n(HT20)_High_2462

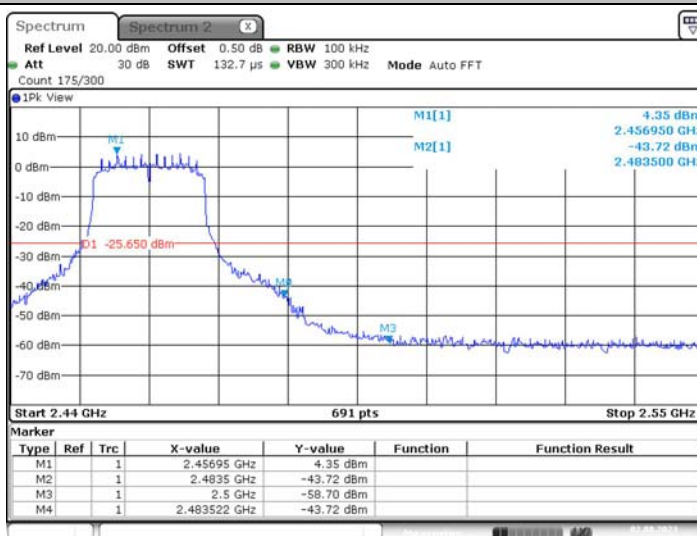

Date: 2.AUG.2023 10:21:43

CTC Laboratories, Inc.

1-2/F., Building 2, Jiaquan Building, Guanlan High-Tech Park, Shenzhen, Guangdong, China
Tel.: (86)755-27521059 Fax: (86)755-27521011 Http://www.sz-ctc.org.cn



For anti-fake verification, please visit the official website of Certification and Accreditation Administration of the People's Republic of China : yz.cnca.cn



802.11n(HT40)_Low_2422

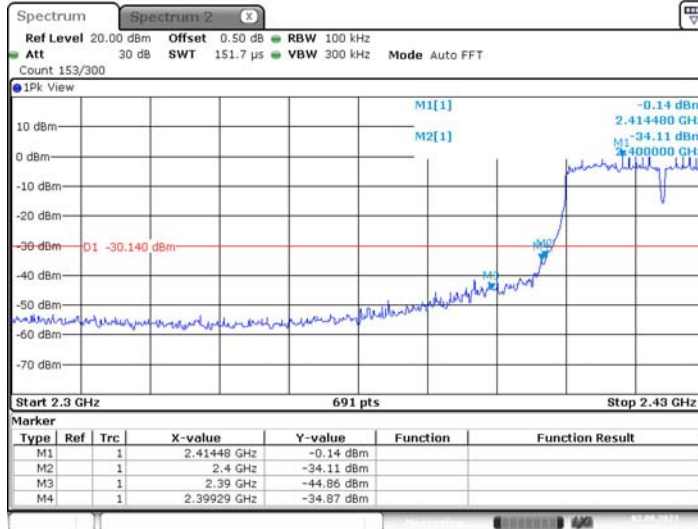

Date: 2.AUG.2023 10:25:11

802.11n(HT40)_High_2452

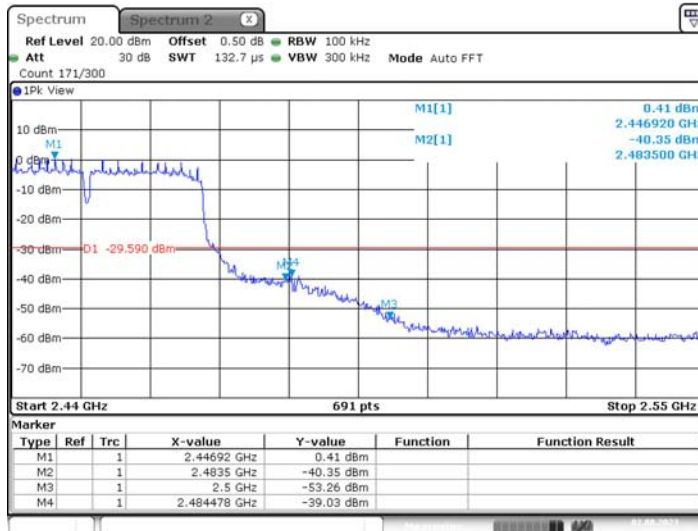

Date: 2.AUG.2023 10:30:42

802.11ax(HE20)_Low_2412

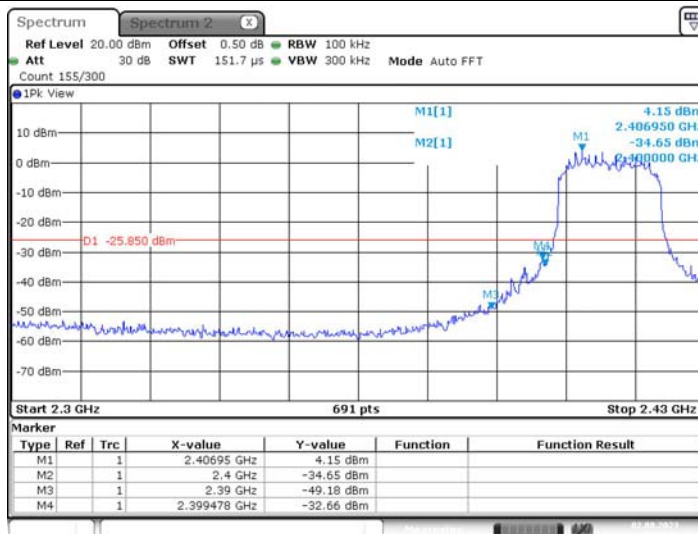

Date: 2.AUG.2023 10:33:44

CTC Laboratories, Inc.

1-2/F., Building 2, Jiaquan Building, Guanlan High-Tech Park, Shenzhen, Guangdong, China
Tel.: (86)755-27521059 Fax: (86)755-27521011 Http://www.sz-ctc.org.cn



For anti-fake verification, please visit the official website of Certification and Accreditation Administration of the People's Republic of China : yz.cnca.cn



802.11ax(HE20)_High_2462

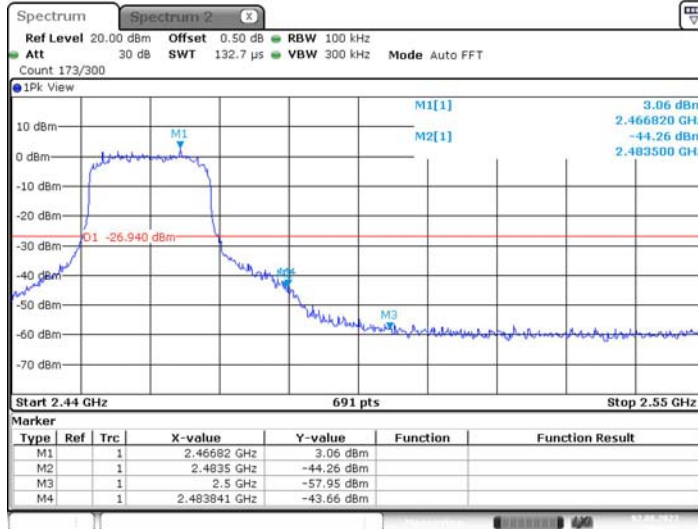

Date: 2.AUG.2023 10:41:51

802.11ax(HE40)_Low_2422

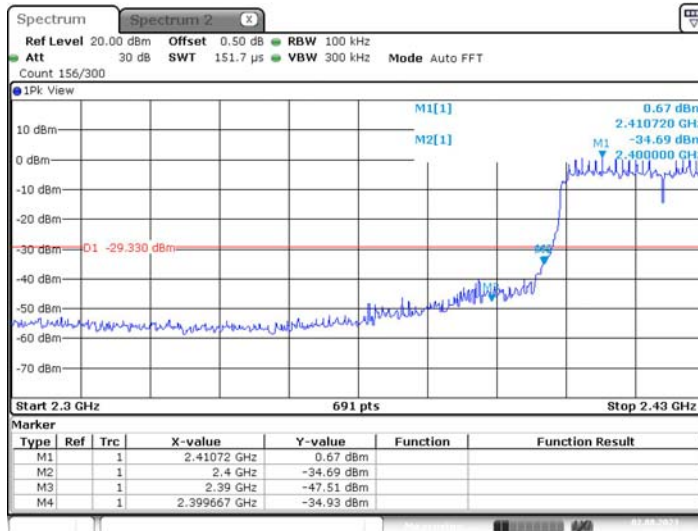

Date: 2.AUG.2023 10:45:01

802.11ax(HE40)_High_2452

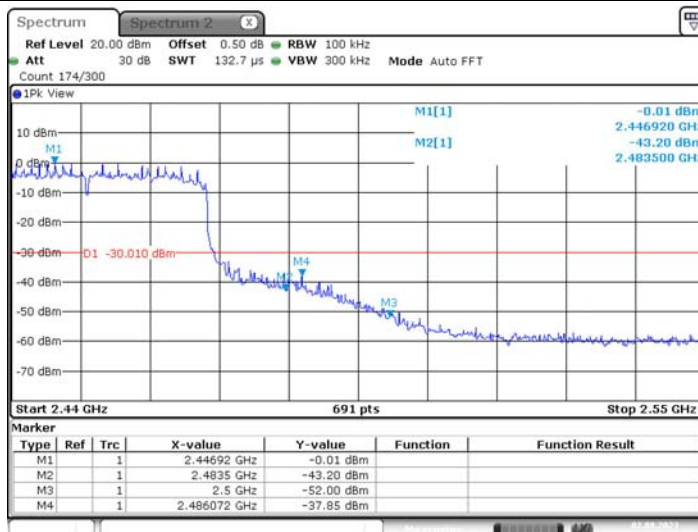

Date: 2.AUG.2023 10:56:30



(2) Conducted Spurious Emissions Test

Test Mode	Channel	Freq Range [Mhz]	Ref Level [dBm]	Result [dBm]	Limit [dBm]	Verdict
802.11b	2412	Reference	11.34	11.34	---	PASS
		30~1000	11.34	-59.73	≤-18.66	PASS
		1000~26500	11.34	-40.24	≤-18.66	PASS
	2437	Reference	10.38	10.38	---	PASS
		30~1000	10.38	-60.66	≤-19.62	PASS
		1000~26500	10.38	-41.03	≤-19.62	PASS
	2462	Reference	10.16	10.16	---	PASS
		30~1000	10.16	-60.63	≤-19.84	PASS
		1000~26500	10.16	-42.45	≤-19.84	PASS
802.11g	2412	Reference	4.51	4.51	---	PASS
		30~1000	4.51	-59.18	≤-25.49	PASS
		1000~26500	4.51	-50.25	≤-25.49	PASS
	2437	Reference	4.12	4.12	---	PASS
		30~1000	4.12	-60.27	≤-25.88	PASS
		1000~26500	4.12	-49.52	≤-25.88	PASS
	2462	Reference	1.55	1.55	---	PASS
		30~1000	1.55	-59.75	≤-28.45	PASS
		1000~26500	1.55	-50.16	≤-28.45	PASS
802.11n(HT20)	2412	Reference	1.84	1.84	---	PASS
		30~1000	1.84	-59.82	≤-28.16	PASS
		1000~26500	1.84	-50.09	≤-28.16	PASS
	2437	Reference	4.10	4.10	---	PASS
		30~1000	4.10	-60.31	≤-25.9	PASS
		1000~26500	4.10	-49.86	≤-25.9	PASS
	2462	Reference	4.28	4.28	---	PASS
		30~1000	4.28	-60.64	≤-25.72	PASS
		1000~26500	4.28	-49.8	≤-25.72	PASS
802.11n(HT40)	2422	Reference	-2.42	-2.42	---	PASS
		30~1000	-2.42	-59.72	≤-32.42	PASS
		1000~26500	-2.42	-50.76	≤-32.42	PASS
	2437	Reference	0.10	0.10	---	PASS
		30~1000	0.10	-60.21	≤-29.9	PASS
		1000~26500	0.10	-49.81	≤-29.9	PASS
	2452	Reference	-0.36	-0.36	---	PASS
		30~1000	-0.36	-59.84	≤-30.36	PASS
		1000~26500	-0.36	-46.05	≤-30.36	PASS
802.11ax(HE20)	2412	Reference	3.34	3.34	---	PASS
		30~1000	3.34	-60.76	≤-26.66	PASS
		1000~26500	3.34	-50.3	≤-26.66	PASS
	2437	Reference	3.86	3.86	---	PASS
		30~1000	3.86	-59.47	≤-26.14	PASS

CTC Laboratories, Inc.

1-2/F., Building 2, Jiaquan Building, Guanlan High-Tech Park, Shenzhen, Guangdong, China

Tel.: (86)755-27521059

Fax: (86)755-27521011

Http://www.sz-ctc.org.cn

中国国家认证认可监督管理委员会
Certification and Accreditation Administration of the People's Republic of ChinaFor anti-fake verification, please visit the official website of Certification and Accreditation Administration of the People's Republic of China: yz.cnca.cn



		1000~26500	3.86	-50.18	≤-26.14	PASS
	2462	Reference	4.51	4.51	---	PASS
		30~1000	4.51	-60.66	≤-25.49	PASS
		1000~26500	4.51	-50.03	≤-25.49	PASS
802.11ax(HE40)	2422	Reference	0.55	0.55	---	PASS
		30~1000	0.55	-59.63	≤-29.45	PASS
		1000~26500	0.55	-49.4	≤-29.45	PASS
	2437	Reference	0.84	0.84	---	PASS
		30~1000	0.84	-58.97	≤-29.16	PASS
		1000~26500	0.84	-49.86	≤-29.16	PASS
	2452	Reference	0.56	0.56	---	PASS
		30~1000	0.56	-60.12	≤-29.44	PASS
		1000~26500	0.56	-49.82	≤-29.44	PASS



802.11b_2412_0~Reference



802.11b_2412_30~1000

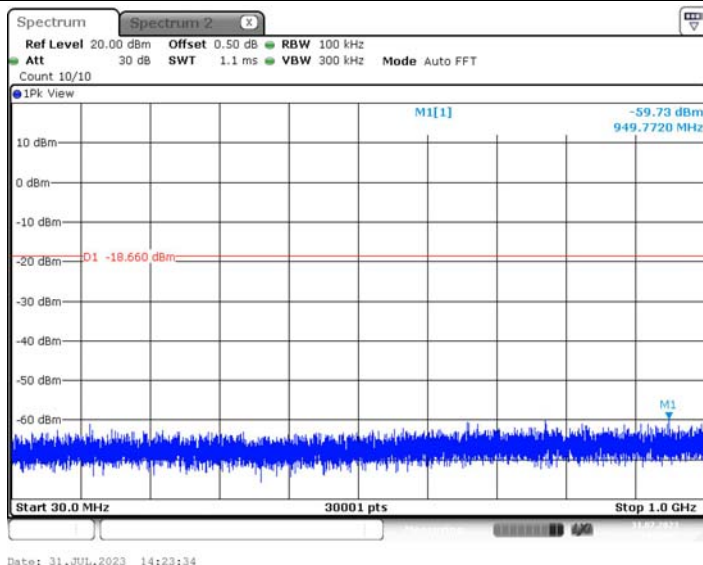

802.11b_2412_1000~26500

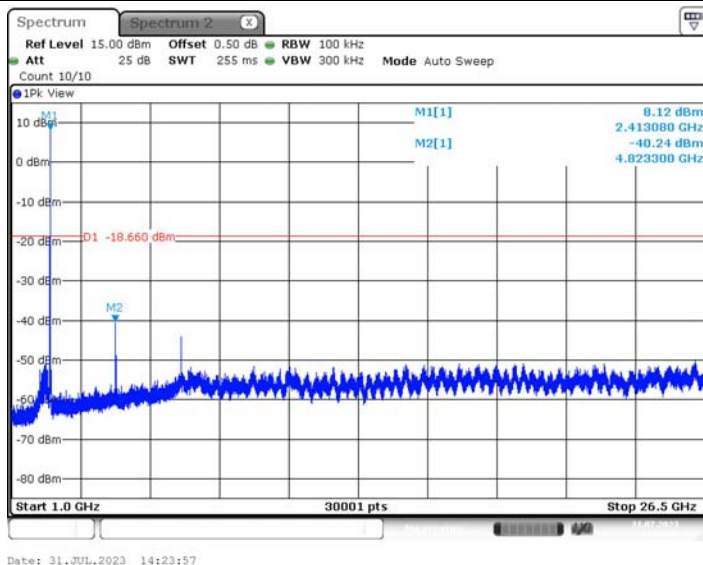

CTC Laboratories, Inc.

1-2/F., Building 2, Jiaquan Building, Guanlan High-Tech Park, Shenzhen, Guangdong, China

Tel.: (86)755-27521059

Fax: (86)755-27521011

Http://www.sz-ctc.org.cn



For anti-fake verification, please visit the official website of Certification and Accreditation Administration of the People's Republic of China : yz.cnca.cn



802.11b_2437_0~Reference



Date: 31.JUL.2023 14:25:56

802.11b_2437_30~1000

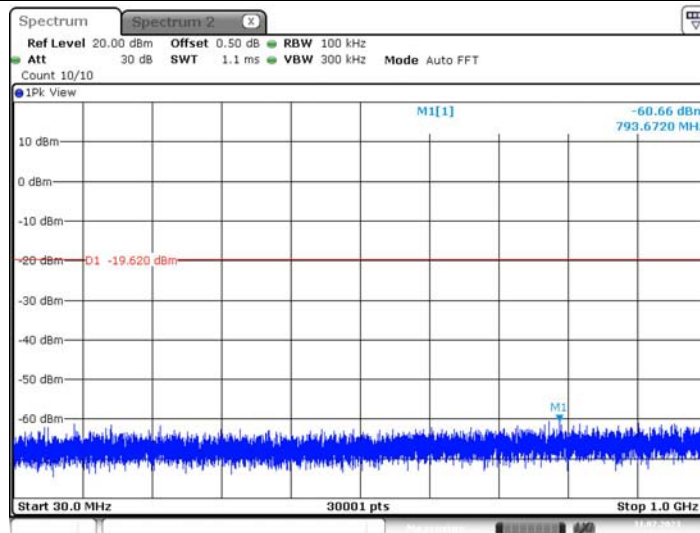

Date: 31.JUL.2023 14:26:02

802.11b_2437_1000~26500

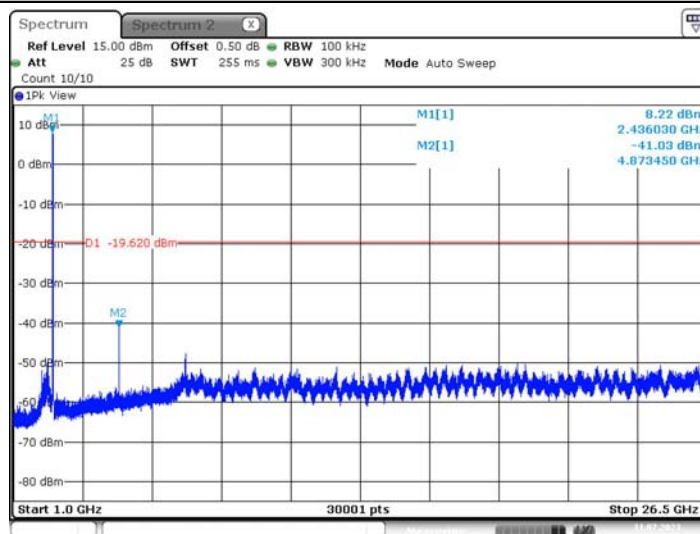

Date: 31.JUL.2023 14:26:25

CTC Laboratories, Inc.

1-2/F., Building 2, Jiaquan Building, Guanlan High-Tech Park, Shenzhen, Guangdong, China
Tel.: (86)755-27521059 Fax: (86)755-27521011 Http://www.sz-ctc.org.cn



For anti-fake verification, please visit the official website of Certification and Accreditation Administration of the People's Republic of China : yz.cnca.cn



802.11b_2462_0~Reference



802.11b_2462_30~1000

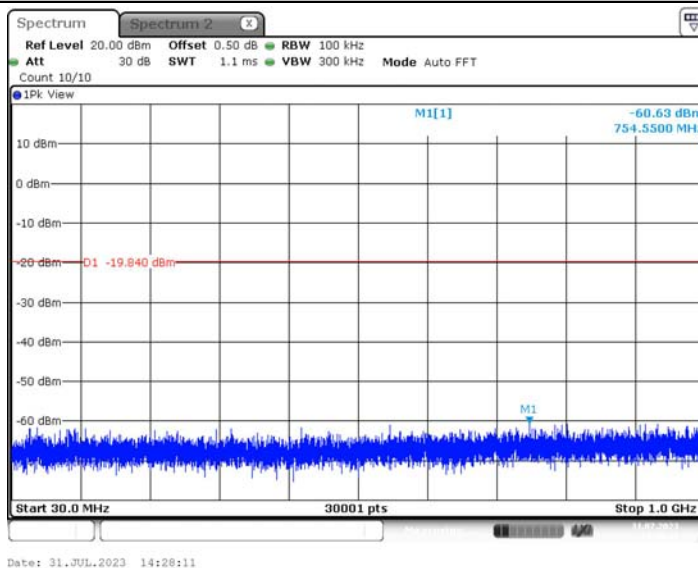

802.11b_2462_1000~26500

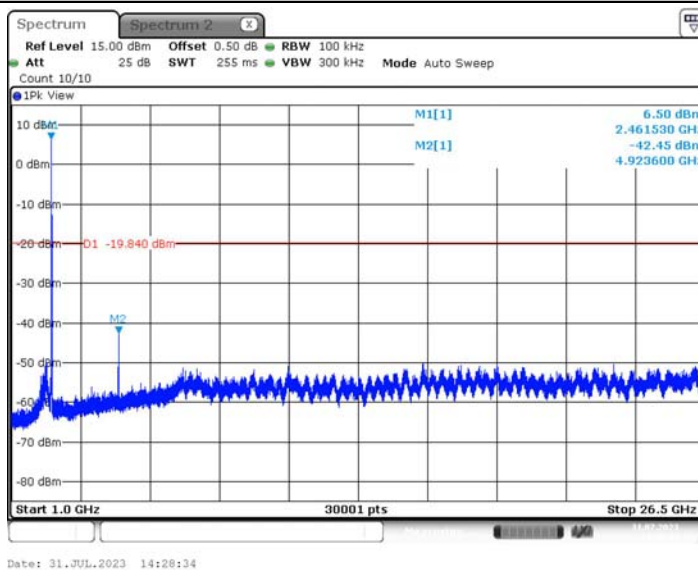

CTC Laboratories, Inc.

1-2/F., Building 2, Jiaquan Building, Guanlan High-Tech Park, Shenzhen, Guangdong, China
Tel.: (86)755-27521059 Fax: (86)755-27521011 Http://www.sz-ctc.org.cn



For anti-fake verification, please visit the official website of Certification and Accreditation Administration of the People's Republic of China: yz.cnca.cn



802.11g_2412_0~Reference

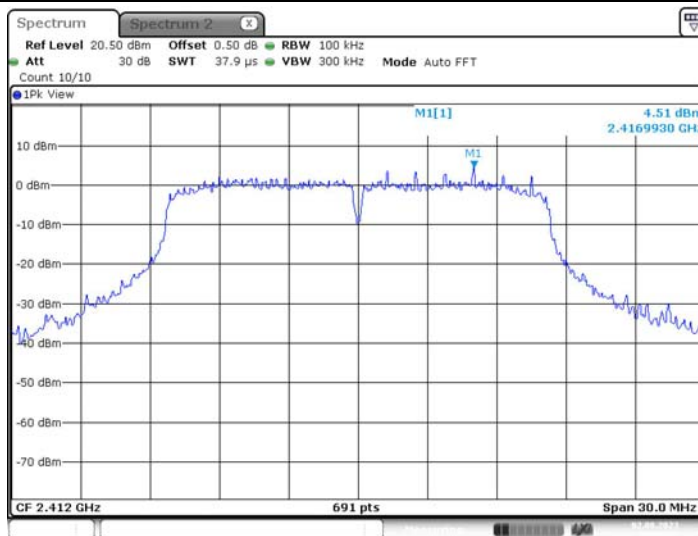

Date: 2.AUG.2023 09:58:29

802.11g_2412_30~1000

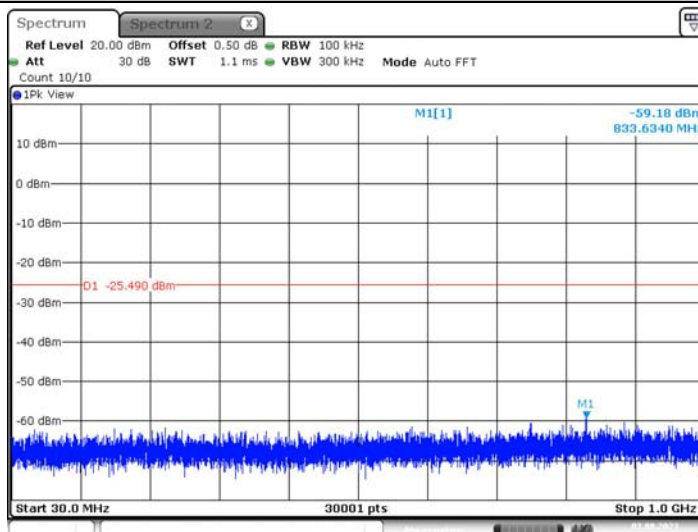

Date: 2.AUG.2023 09:58:34

802.11g_2412_1000~26500

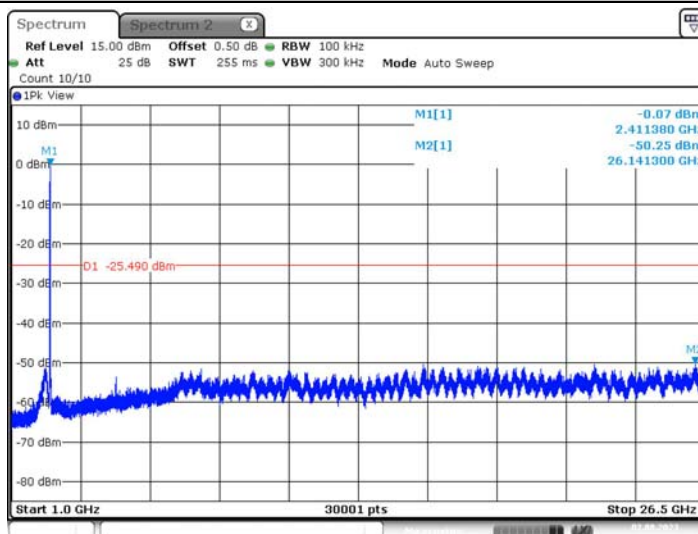

Date: 2.AUG.2023 09:58:58

CTC Laboratories, Inc.

1-2/F., Building 2, Jiaquan Building, Guanlan High-Tech Park, Shenzhen, Guangdong, China
Tel.: (86)755-27521059 Fax: (86)755-27521011 Http://www.sz-ctc.org.cn



For anti-fake verification, please visit the official website of Certification and Accreditation Administration of the People's Republic of China: yz.cnca.cn



802.11g_2437_0~Reference

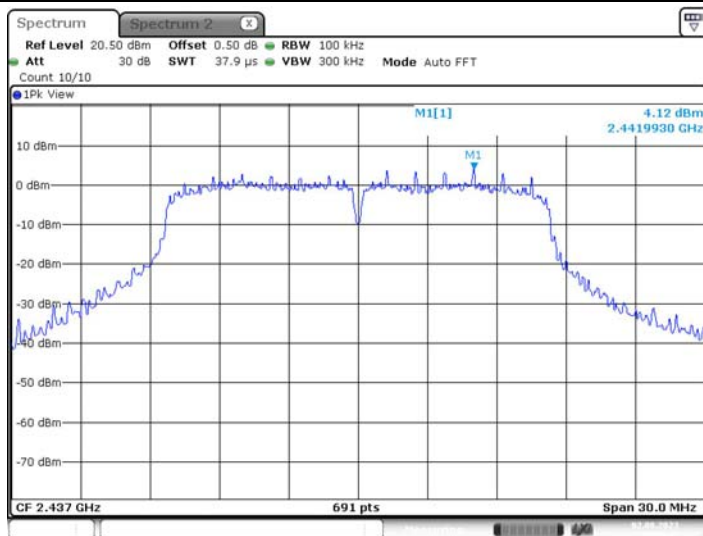

Date: 2.AUG.2023 10:03:18

802.11g_2437_30~1000

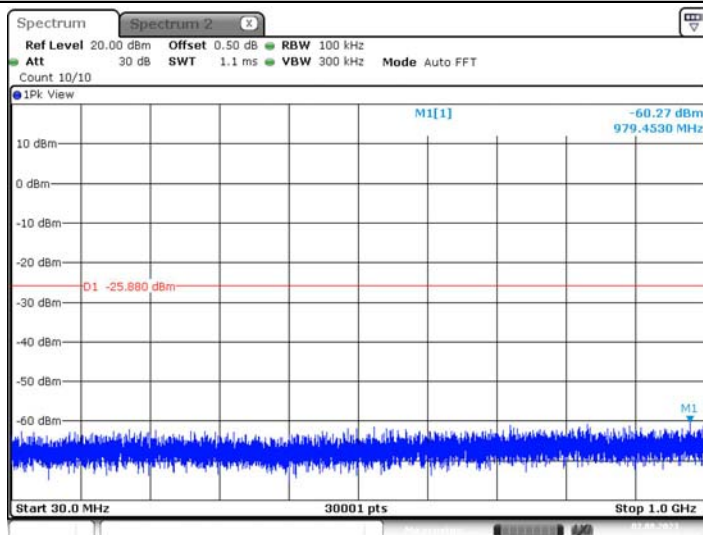

Date: 2.AUG.2023 10:03:24

802.11g_2437_1000~26500

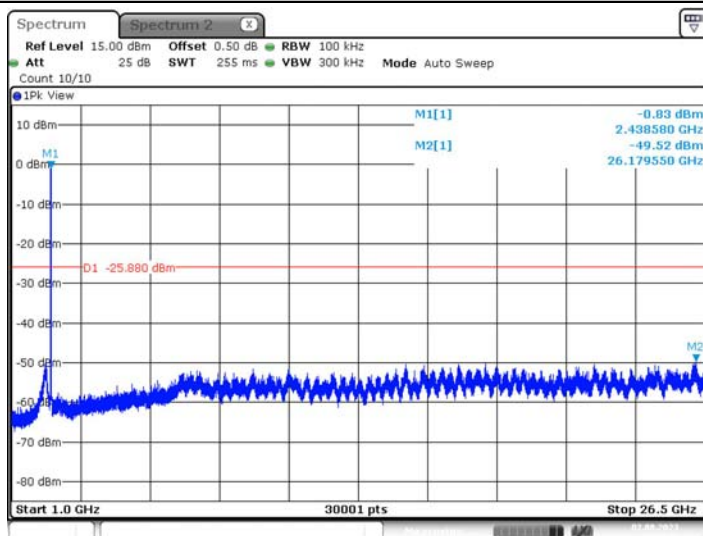

Date: 2.AUG.2023 10:03:47

CTC Laboratories, Inc.

1-2/F., Building 2, Jiaquan Building, Guanlan High-Tech Park, Shenzhen, Guangdong, China
Tel.: (86)755-27521059 Fax: (86)755-27521011 Http://www.sz-ctc.org.cn



For anti-fake verification, please visit the official website of Certification and Accreditation Administration of the People's Republic of China : yz.cnca.cn



802.11g_2462_0~Reference

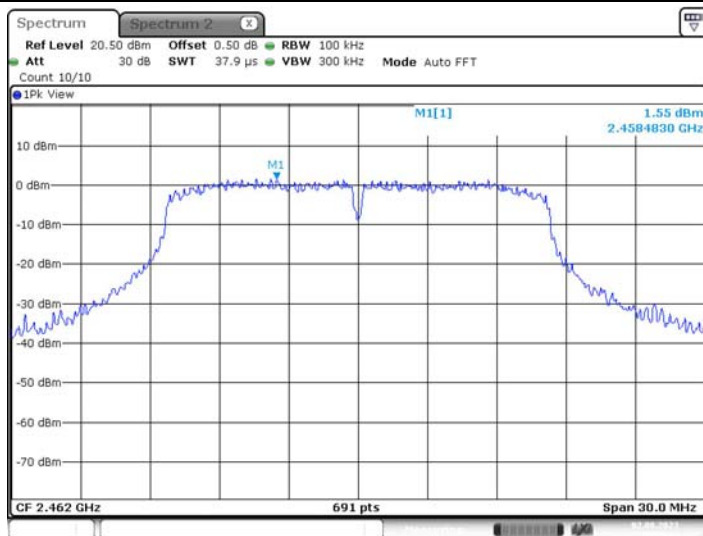

Date: 2.AUG.2023 10:08:44

802.11g_2462_30~1000

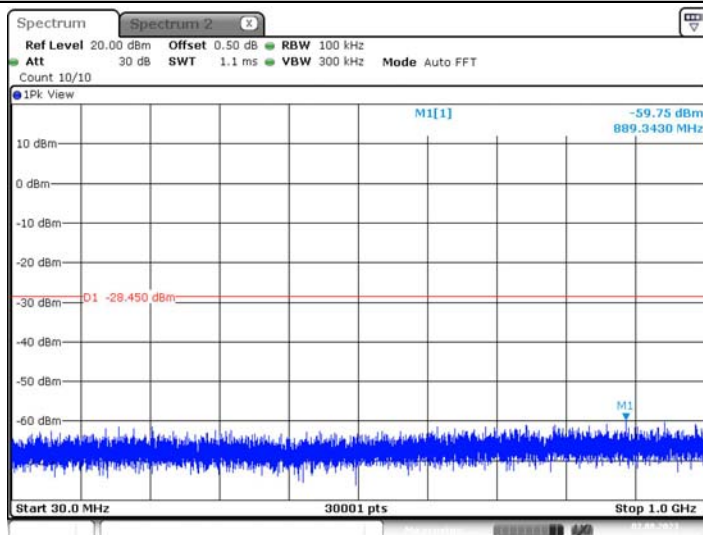

Date: 2.AUG.2023 10:08:50

802.11g_2462_1000~26500

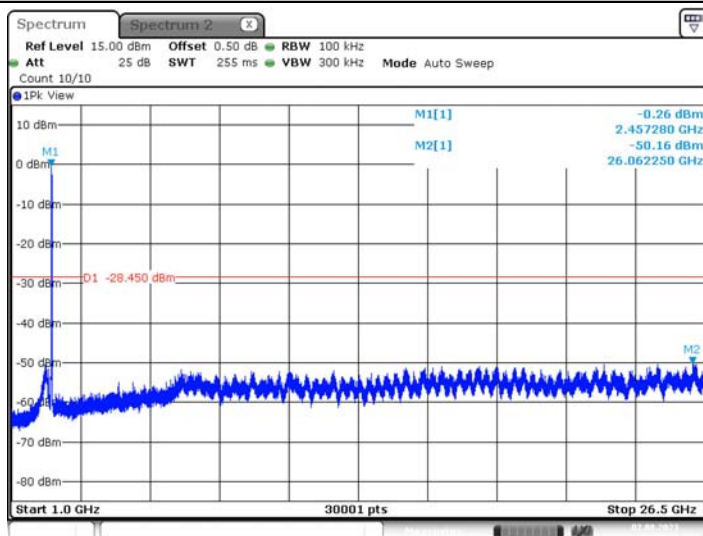

Date: 2.AUG.2023 10:09:13

CTC Laboratories, Inc.

1-2/F., Building 2, Jiaquan Building, Guanlan High-Tech Park, Shenzhen, Guangdong, China
Tel.: (86)755-27521059

Fax: (86)755-27521011 Http://www.sz-ctc.org.cn
For anti-fake verification, please visit the official website of Certification and Accreditation Administration of the People's Republic of China : yz.cnca.cn





802.11n(HT20)_2412_0~Reference

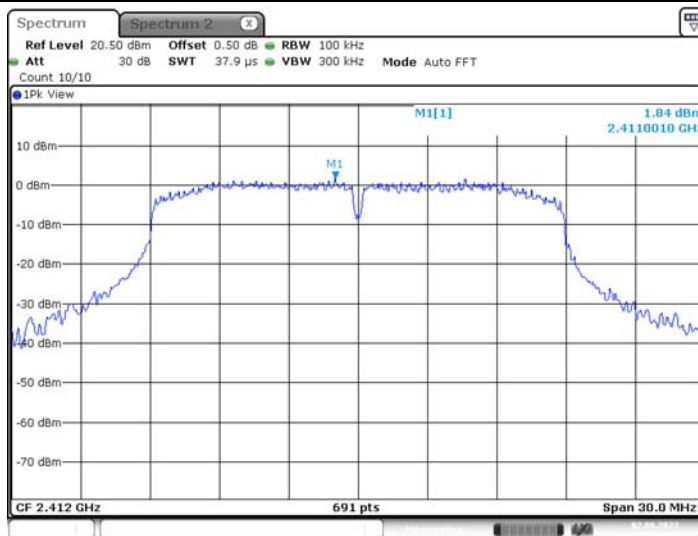

Date: 2.AUG.2023 10:11:57

802.11n(HT20)_2412_30~1000

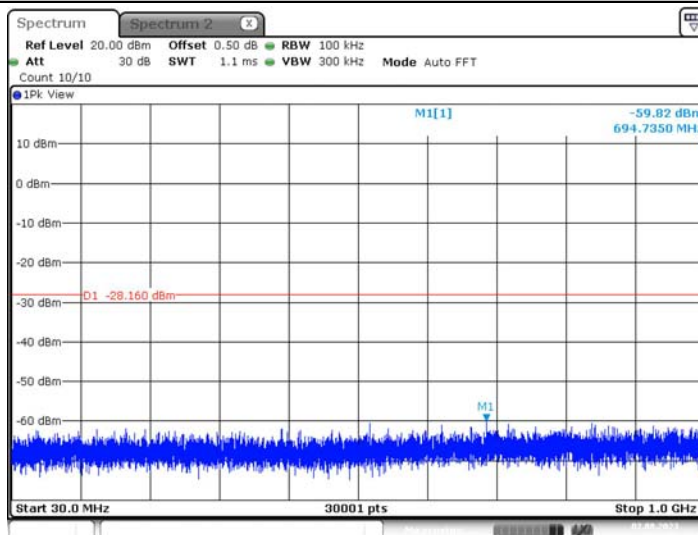

Date: 2.AUG.2023 10:12:02

802.11n(HT20)_2412_1000~26500

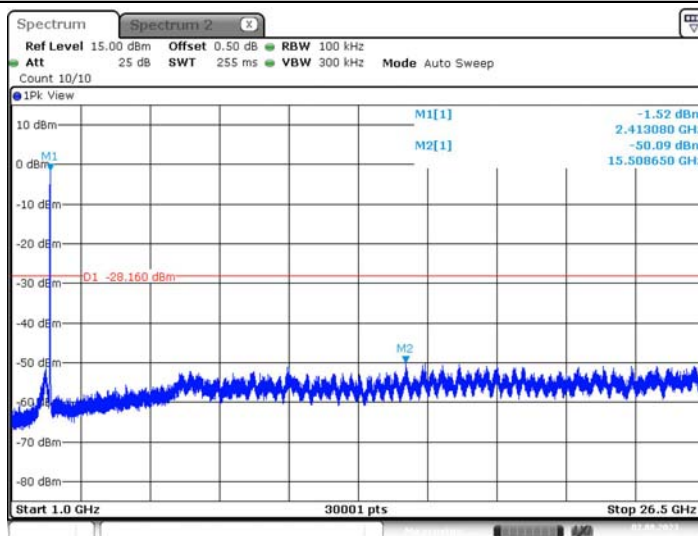

Date: 2.AUG.2023 10:12:26

CTC Laboratories, Inc.

1-2/F., Building 2, Jiaquan Building, Guanlan High-Tech Park, Shenzhen, Guangdong, China

Tel.: (86)755-27521059

Fax: (86)755-27521011

Http://www.sz-ctc.org.cn



For anti-fake verification, please visit the official website of Certification and Accreditation Administration of the People's Republic of China : yz.cnca.cn



802.11n(HT20)_2437_0~Reference

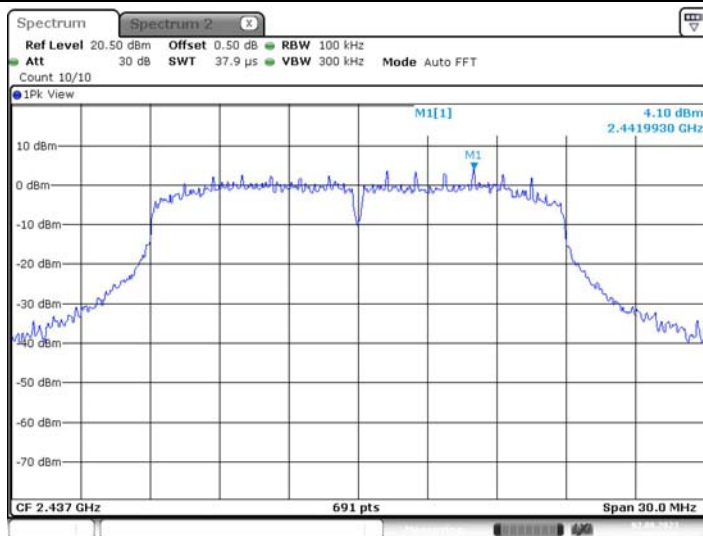

Date: 2.AUG.2023 10:17:25

802.11n(HT20)_2437_30~1000

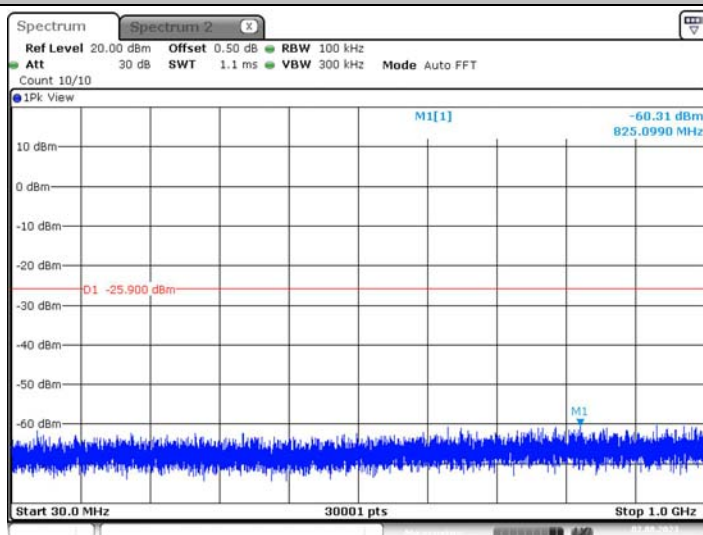

Date: 2.AUG.2023 10:17:31

802.11n(HT20)_2437_1000~26500

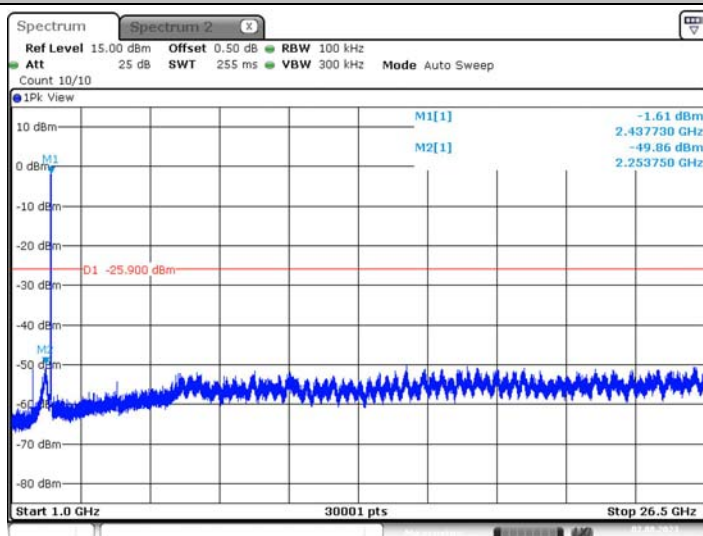

Date: 2.AUG.2023 10:17:54

CTC Laboratories, Inc.

1-2/F., Building 2, Jiaquan Building, Guanlan High-Tech Park, Shenzhen, Guangdong, China
Tel.: (86)755-27521059 Fax: (86)755-27521011 Http://www.sz-ctc.org.cn



For anti-fake verification, please visit the official website of Certification and Accreditation Administration of the People's Republic of China : yz.cnca.cn



802.11n(HT20)_2462_0~Reference

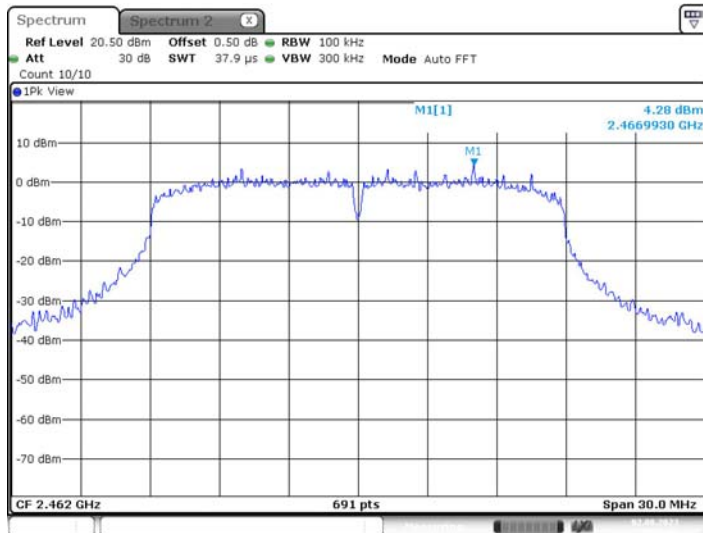

Date: 2.AUG.2023 10:21:49

802.11n(HT20)_2462_30~1000

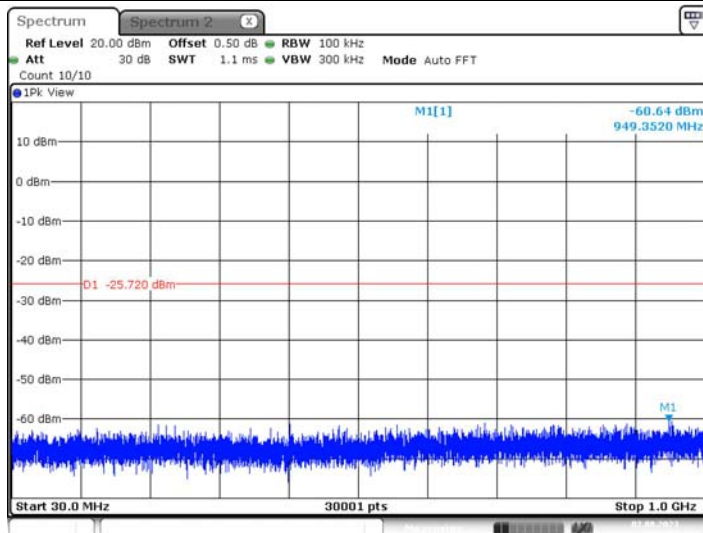

Date: 2.AUG.2023 10:21:55

802.11n(HT20)_2462_1000~26500

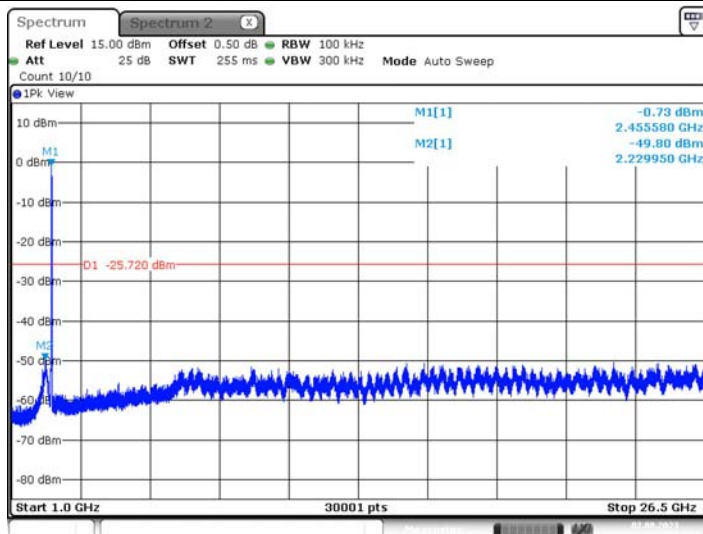

Date: 2.AUG.2023 10:22:18

CTC Laboratories, Inc.

1-2/F., Building 2, Jiaquan Building, Guanlan High-Tech Park, Shenzhen, Guangdong, China
Tel.: (86)755-27521059 Fax: (86)755-27521011 Http://www.sz-ctc.org.cn



For anti-fake verification, please visit the official website of Certification and Accreditation Administration of the People's Republic of China : yz.cnca.cn



802.11n(HT40)_2422_0~Reference

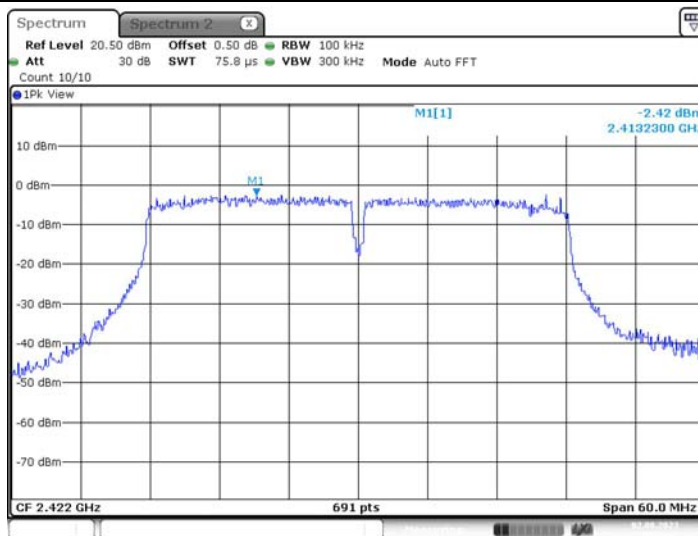

Date: 2.AUG.2023 10:25:18

802.11n(HT40)_2422_30~1000

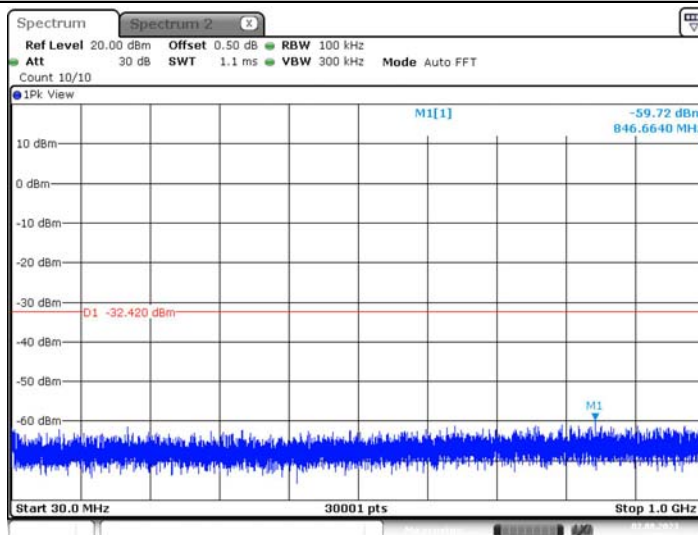

Date: 2.AUG.2023 10:25:23

802.11n(HT40)_2422_1000~26500

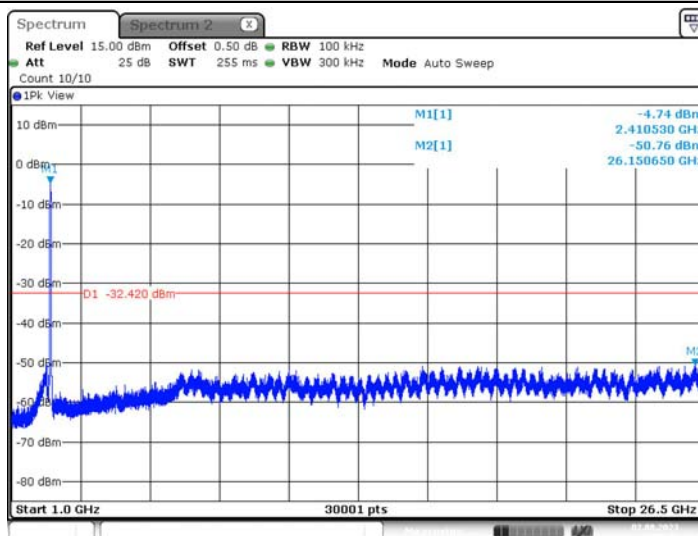

Date: 2.AUG.2023 10:25:47

CTC Laboratories, Inc.

1-2/F., Building 2, Jiaquan Building, Guanlan High-Tech Park, Shenzhen, Guangdong, China
Tel.: (86)755-27521059

Fax: (86)755-27521011 Http://www.sz-ctc.org.cn
For anti-fake verification, please visit the official website of Certification and Accreditation Administration of the People's Republic of China : yz.cnca.cn





802.11n(HT40)_2437_0~Reference

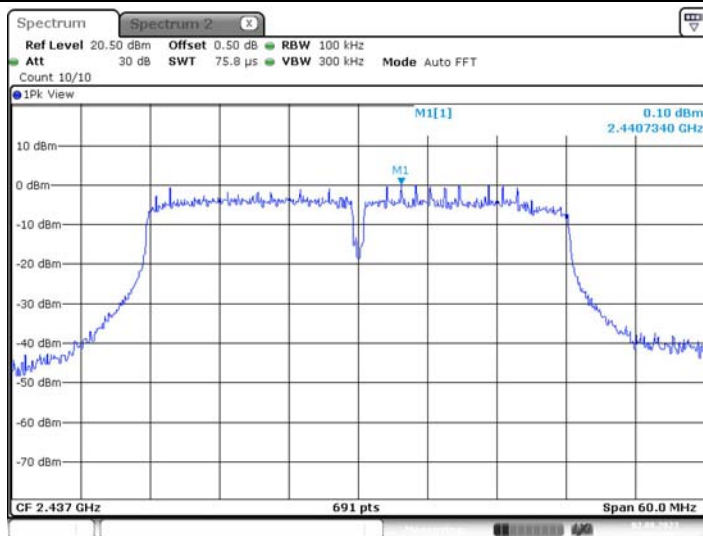

Date: 2.AUG.2023 10:27:53

802.11n(HT40)_2437_30~1000

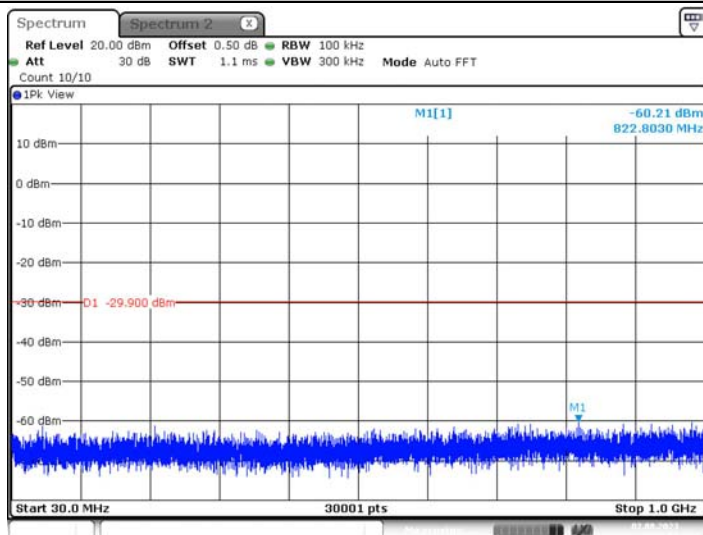

Date: 2.AUG.2023 10:27:58

802.11n(HT40)_2437_1000~26500

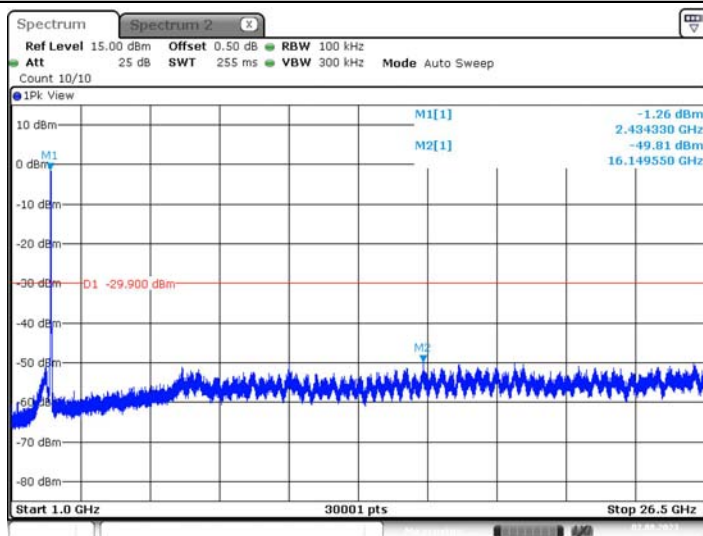

Date: 2.AUG.2023 10:28:22

CTC Laboratories, Inc.

1-2/F., Building 2, Jiaquan Building, Guanlan High-Tech Park, Shenzhen, Guangdong, China

Tel.: (86)755-27521059

Fax: (86)755-27521011

Http://www.sz-ctc.org.cn



For anti-fake verification, please visit the official website of Certification and Accreditation Administration of the People's Republic of China : yz.cnca.cn



802.11n(HT40)_2452_0~Reference

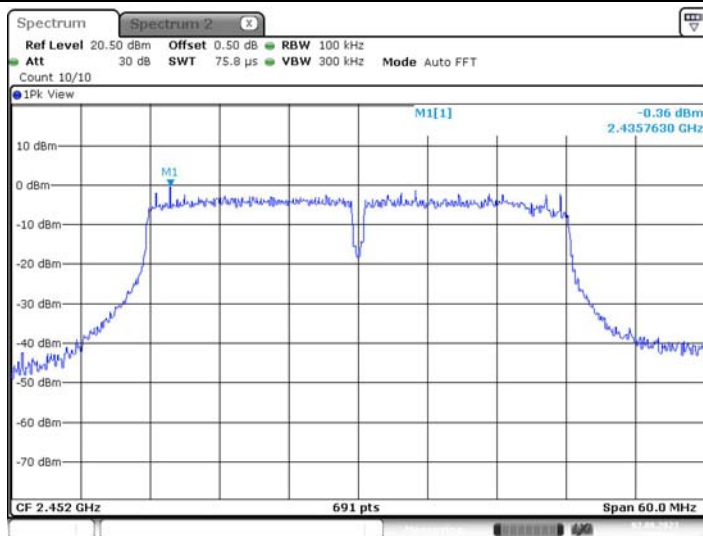

Date: 2.AUG.2023 10:30:48

802.11n(HT40)_2452_30~1000

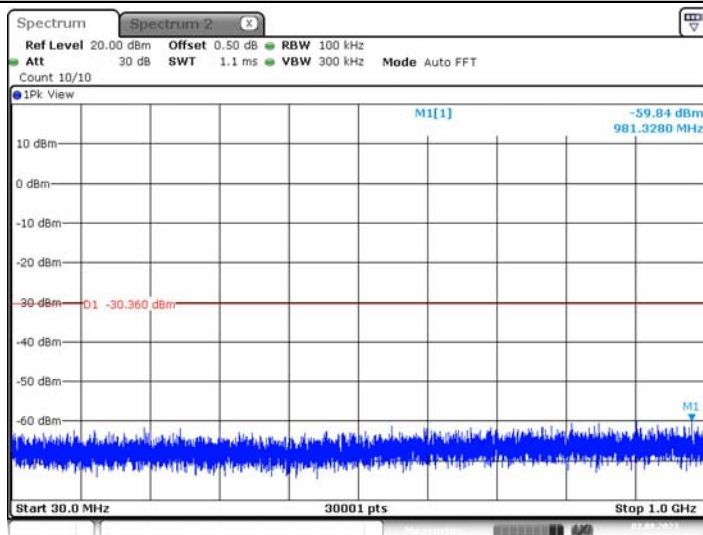

Date: 2.AUG.2023 10:30:54

802.11n(HT40)_2452_1000~26500

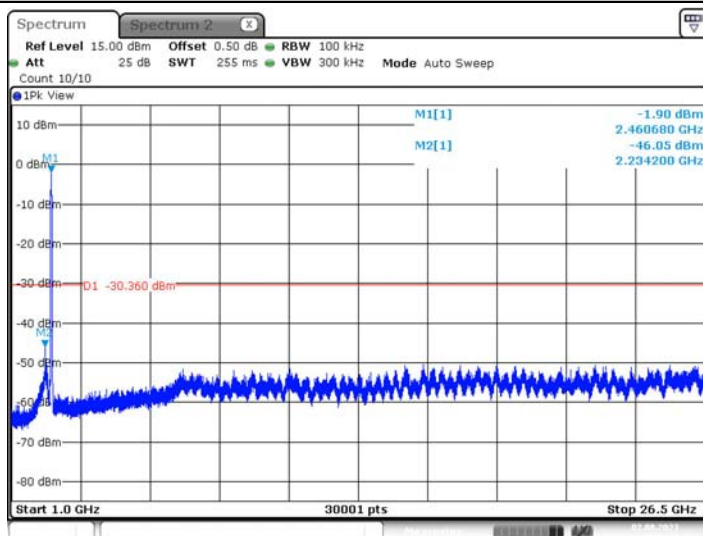

Date: 2.AUG.2023 10:31:17

CTC Laboratories, Inc.

1-2/F., Building 2, Jiaquan Building, Guanlan High-Tech Park, Shenzhen, Guangdong, China
 Tel.: (86)755-27521059 Fax: (86)755-27521011 Http://www.sz-ctc.org.cn



For anti-fake verification, please visit the official website of Certification and Accreditation Administration of the People's Republic of China: yz.cnca.cn



802.11ax(HE20)_2412_0~Reference

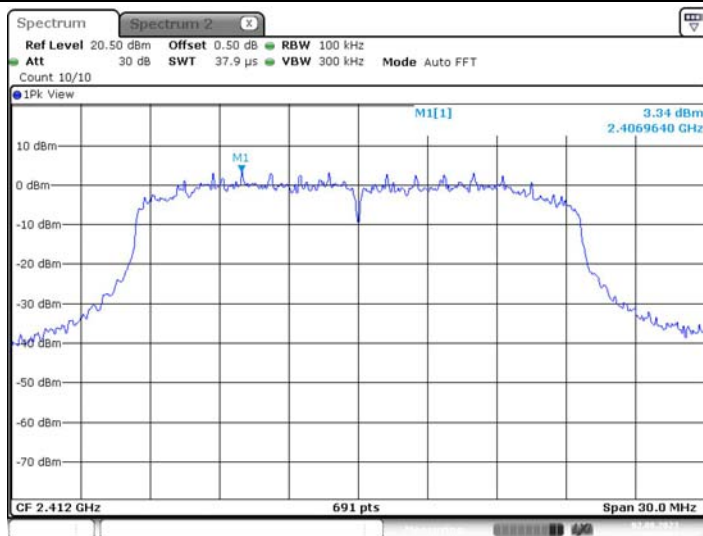

Date: 2.AUG.2023 10:33:51

802.11ax(HE20)_2412_30~1000

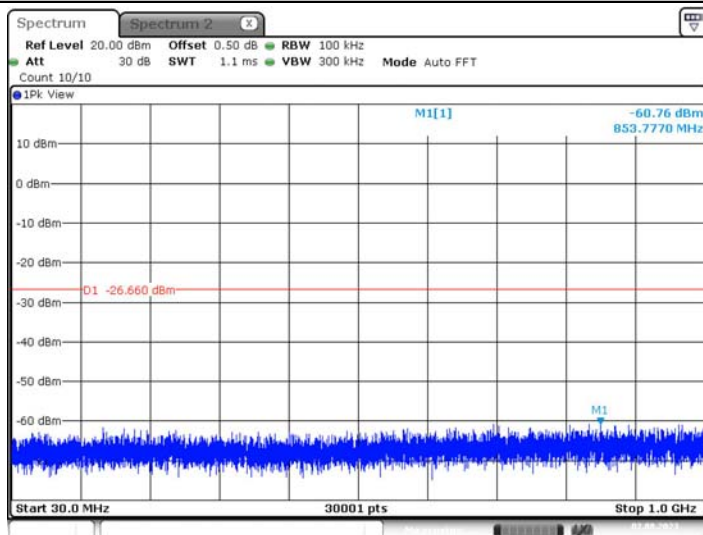

Date: 2.AUG.2023 10:33:57

802.11ax(HE20)_2412_1000~26500

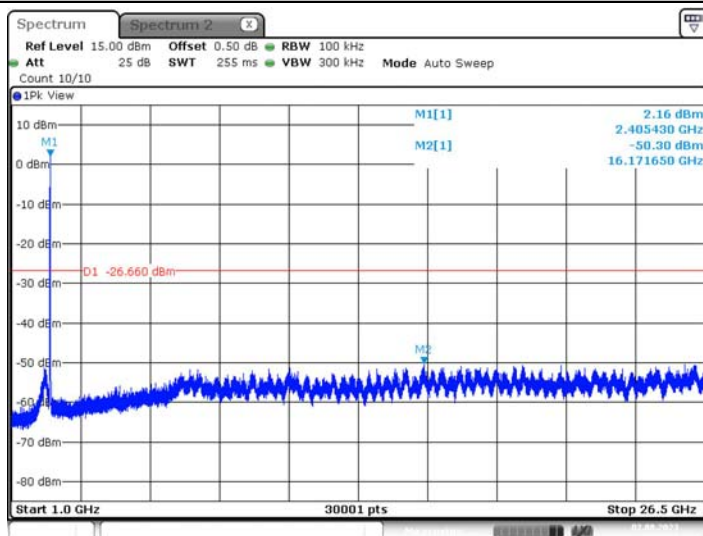

Date: 2.AUG.2023 10:34:20

CTC Laboratories, Inc.

1-2/F., Building 2, Jiaquan Building, Guanlan High-Tech Park, Shenzhen, Guangdong, China
Tel.: (86)755-27521059

Fax: (86)755-27521011 Http://www.sz-ctc.org.cn
For anti-fake verification, please visit the official website of Certification and Accreditation Administration of the People's Republic of China : yz.cnca.cn





802.11ax(HE20)_2437_0~Reference



802.11ax(HE20)_2437_30~1000

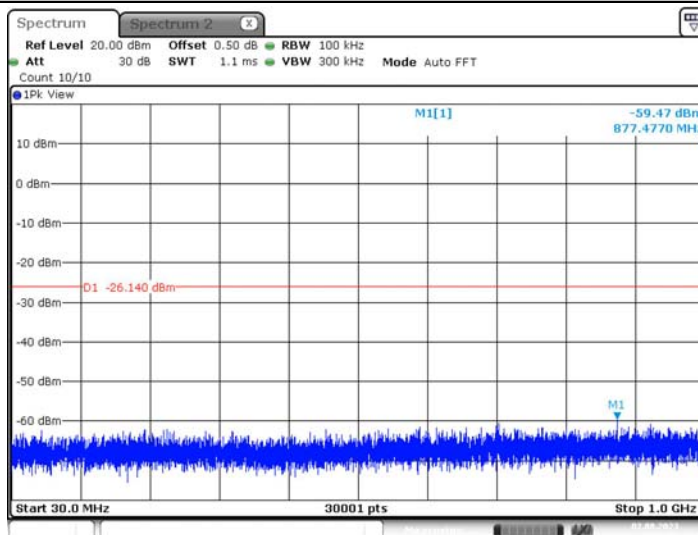

802.11ax(HE20)_2437_1000~26500

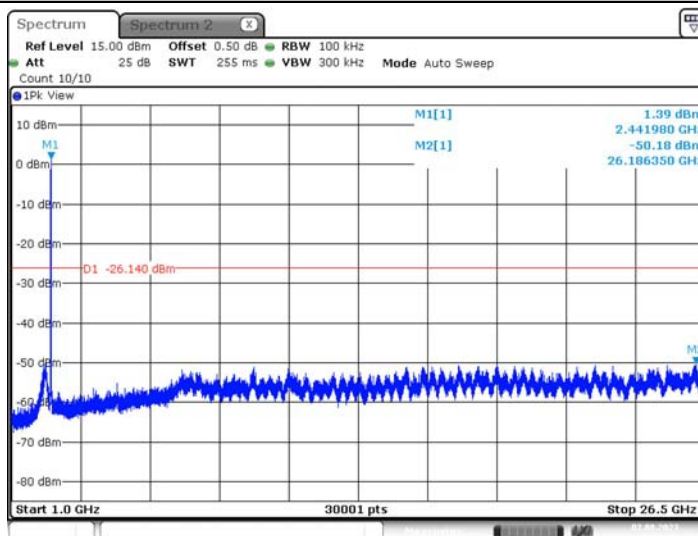

CTC Laboratories, Inc.

1-2/F., Building 2, Jiaquan Building, Guanlan High-Tech Park, Shenzhen, Guangdong, China

Tel.: (86)755-27521059

Fax: (86)755-27521011

Http://www.sz-ctc.org.cn



For anti-fake verification, please visit the official website of Certification and Accreditation Administration of the People's Republic of China : yz.cnca.cn



802.11ax(HE20)_2462_0~Reference

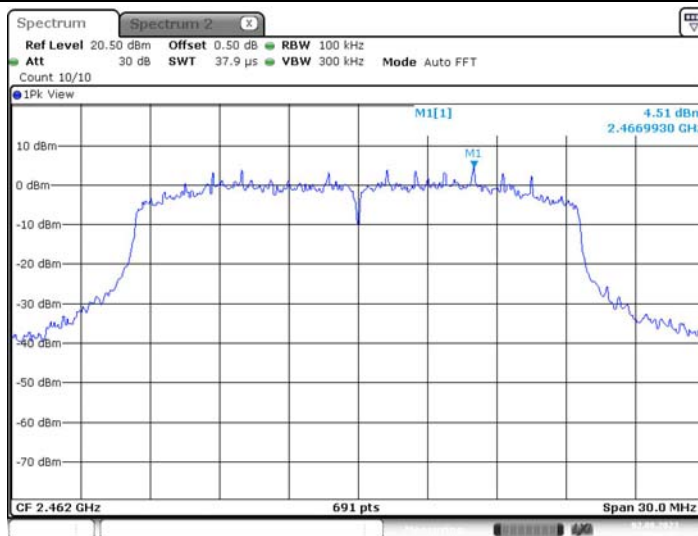

Date: 2.AUG.2023 10:41:58

802.11ax(HE20)_2462_30~1000

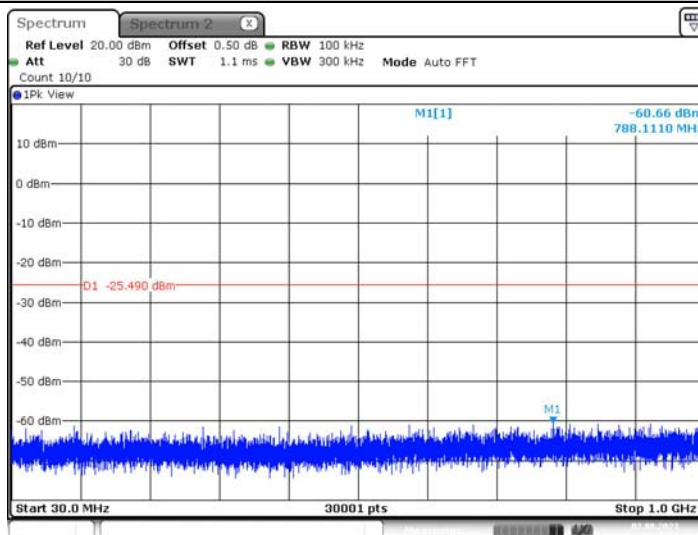

Date: 2.AUG.2023 10:42:03

802.11ax(HE20)_2462_1000~26500

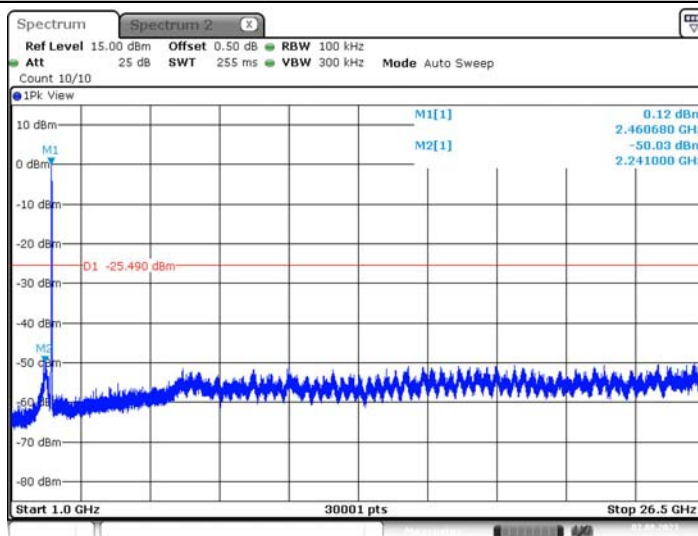

Date: 2.AUG.2023 10:42:27

CTC Laboratories, Inc.

1-2/F., Building 2, Jiaquan Building, Guanlan High-Tech Park, Shenzhen, Guangdong, China

Tel.: (86)755-27521059

Fax: (86)755-27521011

Http://www.sz-ctc.org.cn



For anti-fake verification, please visit the official website of Certification and Accreditation Administration of the People's Republic of China : yz.cnca.cn