



TESTING LABORATORY
CERTIFICATE #4820.01



FCC PART 15.247

TEST REPORT

For

Beijing COTX Networks Technologies Co. Ltd.

B218, block F, Wangjing, Wanke times center, Chaoyang District, Beijing

FCC ID: 2A2A2X3

Report Type: Original Report	Product Name: cotx x3 hotspot
Report Number:	<u>SZGMA210604-21533E-00A</u>
Report Date:	<u>2021-07-23</u>
Reviewed By:	<u>Ivan Cao</u> Assistant Manager 
Test Laboratory:	Bay Area Compliance Laboratories Corp. (Dongguan) No.12, Pulong East 1 st Road, Tangxia Town, Dongguan, Guangdong, China Tel: +86-769-86858888 Fax: +86-769-86858891 www.baclcorp.com.cn

TABLE OF CONTENTS

GENERAL INFORMATION.....	4
PRODUCT DESCRIPTION FOR EQUIPMENT UNDER TEST (EUT).....	4
OBJECTIVE	4
TEST METHODOLOGY	4
MEASUREMENT UNCERTAINTY	5
TEST FACILITY	5
DECLARATIONS.....	5
SYSTEM TEST CONFIGURATION.....	6
DESCRIPTION OF TEST CONFIGURATION	6
EQUIPMENT MODIFICATIONS	6
EUT EXERCISE SOFTWARE	7
LOCAL SUPPORT EQUIPMENT LIST AND DETAILS	10
SUPPORT CABLE LIST AND DETAILS	10
BLOCK DIAGRAM OF TEST SETUP	11
SUMMARY OF TEST RESULTS.....	12
FCC §15.247 (i) & §1.1310 & §2.1091- MAXIMUM PERMISSIBLE EXPOSURE (MPE).....	13
APPLICABLE STANDARD	13
FCC §15.203 - ANTENNA REQUIREMENT.....	15
APPLICABLE STANDARD	15
ANTENNA CONNECTOR CONSTRUCTION	15
FCC §15.207 (a) – AC LINE CONDUCTED EMISSIONS	16
APPLICABLE STANDARD	16
EUT SETUP	16
EMI TEST RECEIVER SETUP	16
TEST PROCEDURE	17
CORRECTED AMPLITUDE & MARGIN CALCULATION	17
TEST EQUIPMENT LIST AND DETAILS.....	17
TEST DATA	18
FCC §15.209, §15.205 & §15.247(d) - SPURIOUS EMISSIONS.....	20
APPLICABLE STANDARD	20
EUT SETUP.....	20
EMI TEST RECEIVER & SPECTRUM ANALYZER SETUP	21
TEST PROCEDURE	21
CORRECTED AMPLITUDE & MARGIN CALCULATION	21
TEST EQUIPMENT LIST AND DETAILS.....	22
TEST DATA	22
FCC §15.247(a) (2)–6 dB EMISSION BANDWIDTH.....	32
APPLICABLE STANDARD	32
TEST PROCEDURE	32
TEST EQUIPMENT LIST AND DETAILS.....	32
TEST DATA	32
FCC §15.247(b) (3) - MAXIMUM PEAK CONDUCTED OUTPUT POWER.....	42
APPLICABLE STANDARD	42
TEST PROCEDURE	42
TEST EQUIPMENT LIST AND DETAILS.....	42

TEST DATA	43
FCC §15.247(d)– 100 kHz BANDWIDTH OF FREQUENCY BAND EDGE.....	44
APPLICABLE STANDARD	44
TEST PROCEDURE	44
TEST EQUIPMENT LIST AND DETAILS.....	44
TEST DATA	45
FCC §15.247(e) - POWER SPECTRAL DENSITY	51
APPLICABLE STANDARD	51
TEST PROCEDURE	51
TEST EQUIPMENT LIST AND DETAILS.....	51
TEST DATA	51

F E M N A L

GENERAL INFORMATION

Product Description for Equipment under Test (EUT)

EUT Name:	cotx x3 hotspot
EUT Model:	X3
Operation Frequency:	2412-2462 MHz(802.11b/g/n ht20), 2422-2452 MHz(802.11n ht40) 2402-2480MHz(BLE)
Maximum Peak Output Power (Conducted):	14.52 dBm(802.11b/g/n) -4.59 dBm(BLE)
Modulation Type:	DSSS, OFDM(802.11b/g/n) GFSK(BLE)
Antenna Gain[▲]:	3.5 dBi
Rated Input Voltage:	DC 5V from DC Port
Serial Number:	SZGMA210604-21533E-RF-S1
EUT Received Date:	2021.06.05
EUT Received Status:	Good

Objective

This report is prepared on behalf of **Beijing COTX Networks Technologies Co. Ltd.** in accordance with Part 2, Subpart J, Part 15, Subparts A and C of the Federal Communications Commission's rules.

The tests were performed in order to determine the compliance of the EUT with FCC Rules Part 15-Subpart C, section 15.203, 15.205, 15.207, 15.209 and 15.247 rules.

Test Methodology

All measurements contained in this report were conducted with ANSI C63.10-2013, American National Standard of Procedures for Compliance Testing of Unlicensed Wireless Devices and KDB 558074 D01 DTS Meas Guidance v05r02.

All emissions measurement was performed and Bay Area Compliance Laboratories Corp. (Dongguan).

Measurement Uncertainty

Parameter	Measurement Uncertainty
Occupied Channel Bandwidth	±5 %
RF output power, conducted	±0.61dB
Power Spectral Density, conducted	±0.61 dB
Unwanted Emissions, radiated	30M~200MHz: 4.55 dB,200M~1GHz: 5.92 dB,1G~6GHz: 4.98 dB, 6G~18GHz: 5.89 dB,18G~26.5G:5.47 dB,26.5G~40G:5.63 dB
Unwanted Emissions, conducted	±1.5 dB
Temperature	±1 °C
Humidity	±5%
DC and low frequency voltages	±0.4%
Duty Cycle	1%
AC Power Lines Conducted Emission	3.12 dB (150 kHz to 30 MHz)

Note: Otherwise required by the applicant or Product Regulations, Decision Rule in this report did not consider the uncertainty. The extended uncertainty given in this report is obtained by combining the standard uncertainty times the coverage factor K with the 95% confidence interval.

Test Facility

The Test site used by Bay Area Compliance Laboratories Corp. (Dongguan) to collect test data is located on the No.12, Pulong East 1st Road, Tangxia Town, Dongguan, Guangdong, China.

The lab has been recognized as the FCC accredited lab under the KDB 974614 D01 and is listed in the FCC Public Access Link (PAL) database, FCC Registration No. : 897218, the FCC Designation No. : CN1220.

The lab has been recognized by Innovation, Science and Economic Development Canada to test to Canadian radio equipment requirements, the CAB identifier: CN0022.

Declarations

BACL is not responsible for the authenticity of any test data provided by the applicant. Data included from the applicant that may affect test results are marked with a triangle symbol “▲”. Customer model name, addresses, names, trademarks etc. are not considered data.

Unless otherwise stated the results shown in this test report refer only to the sample(s) tested.

This report cannot be reproduced except in full, without prior written approval of the Company.

This report is valid only with a valid digital signature. The digital signature may be available only under the Adobe software above version 7.0.

This report may contain data that are not covered by the accreditation scope and shall be marked with an asterisk “★”.

SYSTEM TEST CONFIGURATION

Description of Test Configuration

The system was configured for testing in Engineering Mode, which was provided by the manufacturer.

For 2.4GHz band, total 11 channels are provided:

Channel	Frequency (MHz)	Channel	Frequency (MHz)
1	2412	7	2442
2	2417	8	2447
3	2422	9	2452
4	2427	10	2457
5	2432	11	2462
6	2437	/	/

For 802.11b, 802.11g, and 802.11n ht20 modes were test with channel 1, 6, 11.

For 802.11n ht40 modes were test with channel 3, 6, 9.

The worst-case data rates are determined to be as follows for each mode based upon investigations by measuring the average power and PSD across all data rates, bandwidths, and modulations.

For Bluetooth LE mode, 40 channels are provided for testing:

Channel	Frequency (MHz)	Channel	Frequency (MHz)
0	2402	20	2442
1	2404
...
...
..	...	38	2478
19	2440	39	2480

EUT was tested with channel 0, 19 and 39.

Equipment Modifications

No modification was made to the EUT.

EUT Exercise Software

The 'PUTTY' was used during test, which was provided by manufacturer. The maximum power level was configured by the software as below table▲:

Mode	Channel	Frequency (MHz)	Data Rate	Power level Setting
802.11b	Low	2412	1 Mbps	-1
	Middle	2437	1 Mbps	-1
	High	2462	1 Mbps	-1
802.11g	Low	2412	6 Mbps	-1
	Middle	2437	6 Mbps	-1
	High	2462	6 Mbps	-1
802.11n ht20	Low	2412	MCS0	-1
	Middle	2437	MCS0	-1
	High	2462	MCS0	-1
802.11n ht40	Low	2422	MCS0	-1
	Middle	2437	MCS0	-1
	High	2452	MCS0	-1
BLE	Low	2402	1 Mbps	Default
	Middle	2440	1 Mbps	Default
	High	2480	1 Mbps	Default

The maximum duty cycle as following table:

Test mode	T _{on} (ms)	T _{on+off} (ms)	Duty Cycle (%)
802.11b	30	30	100.00
802.11g	1.43	1.45	98.62
802.11n ht20	1.33	1.35	98.52
802.11n ht40	0.666	0.696	95.69
BLE	0.420	0.624	67.31

802.11b

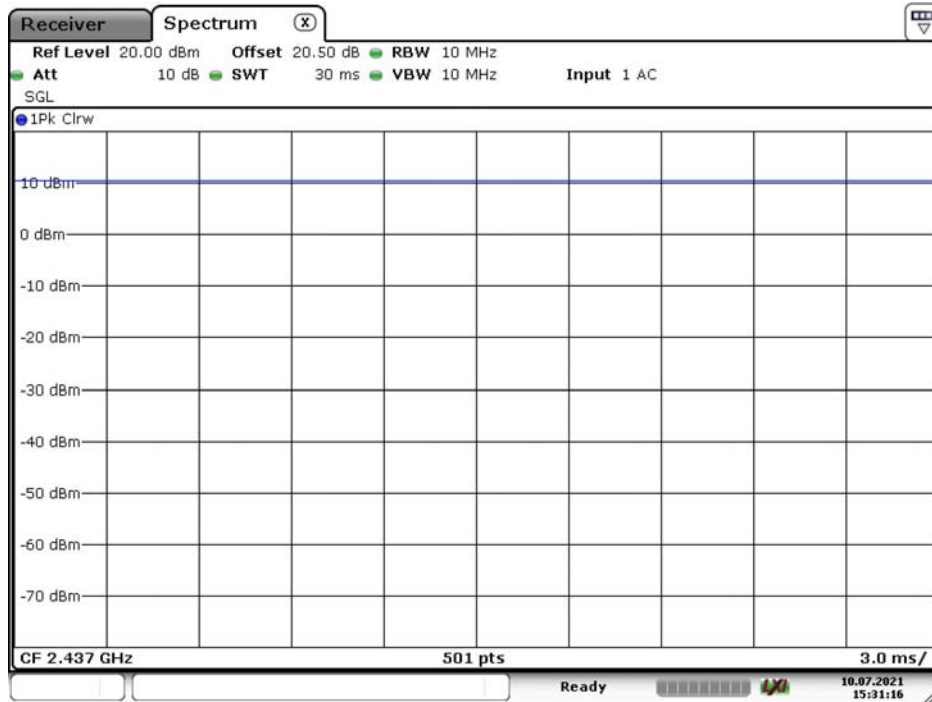

Date: 10.JUL.2021 15:31:16

802.11g

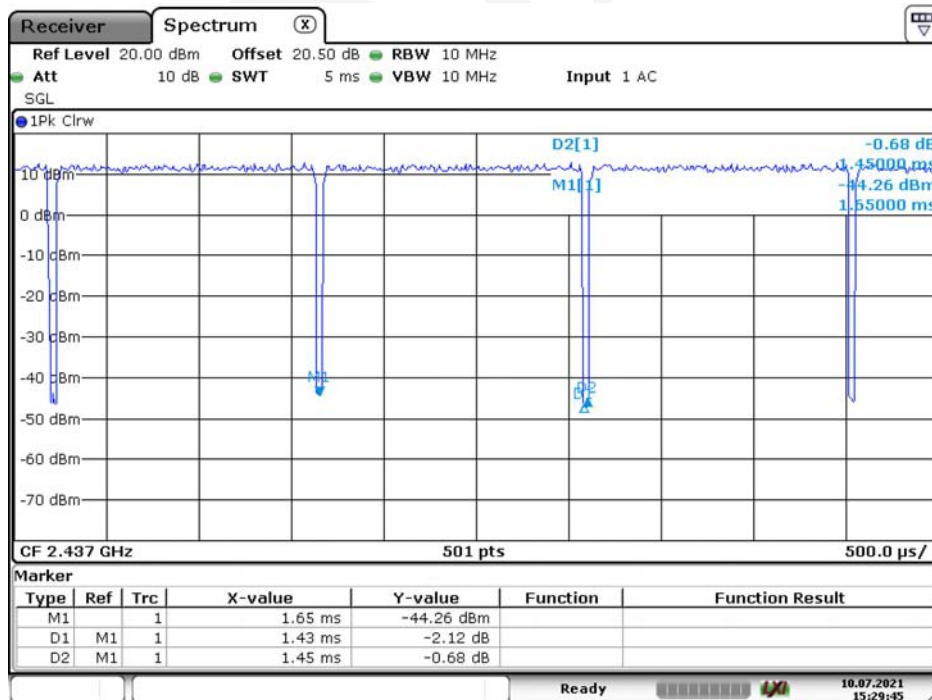

Date: 10.JUL.2021 15:29:45

802.11n ht20

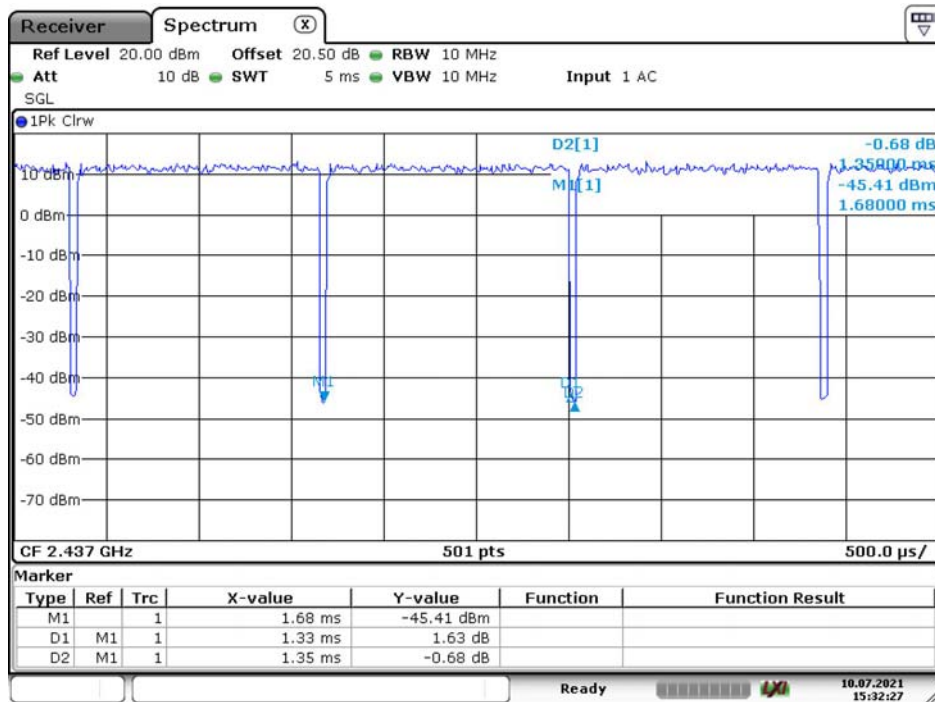

Date: 10.JUL.2021 15:32:27

802.11n ht40

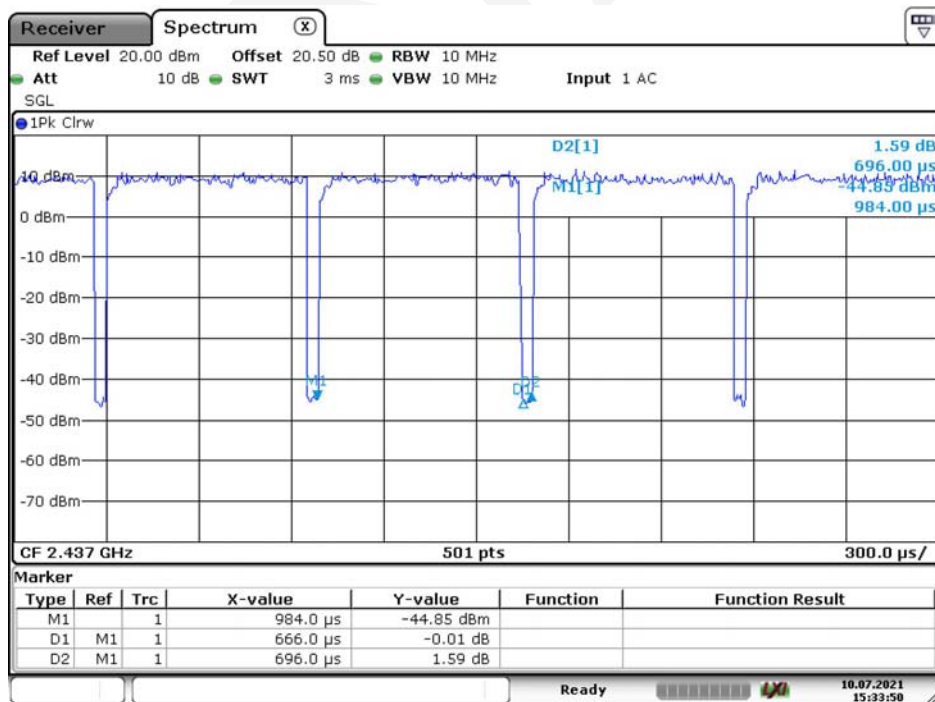

Date: 10.JUL.2021 15:33:49

BLE

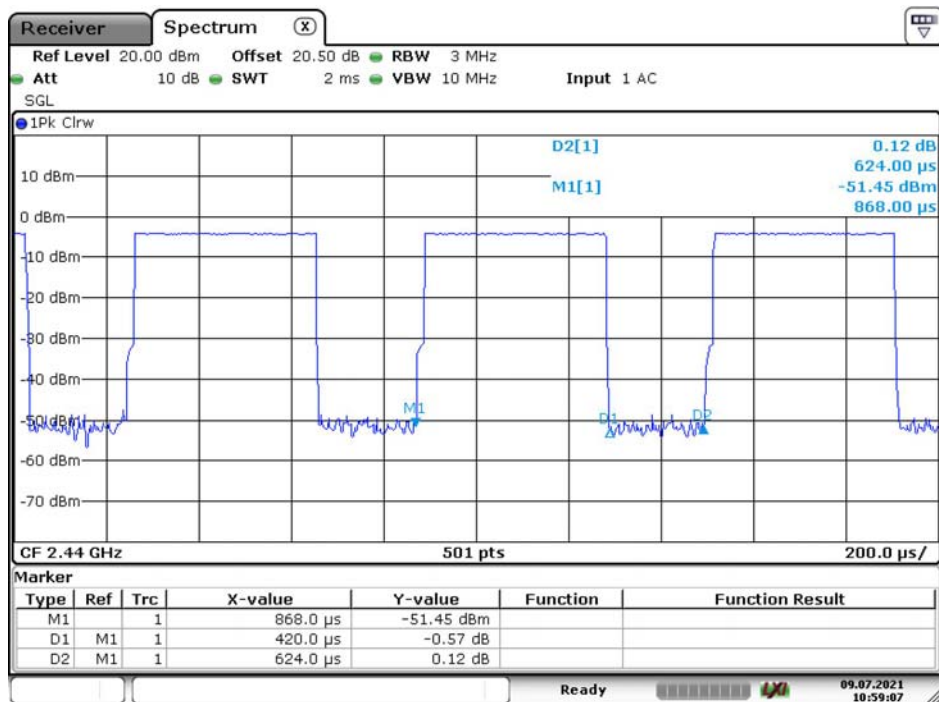

Date: 9.JUL.2021 10:59:07

Local Support Equipment List and Details

Manufacturer	Description	Model	Serial Number
Hytera	Adapter	S010WU0500200	S010WU0500200
COTX	Camera	Un-known	SZGMA210604-21533E-RF-S2
DELL	Laptop	E6410	QDS-BRCM1017
Un-known	Earphone	Un-known	Earphone2
KINGSTON	U disk	32G	32G-1
KEYSIGHT	U disk	32G	32G-2
SANDISK	TF card	SDDR-C531	SDDR-C531-2

Support Cable List and Details

Cable Description	Shielding Type	Ferrite Core	Length (m)	From Port	To
Adapter Cable	No	No	1.5	adapter	EUT
RJ45	No	No	10	EUT	Laptop
Earphone Cable	No	No	1.2	EUT	Earphone

Block Diagram of Test Setup

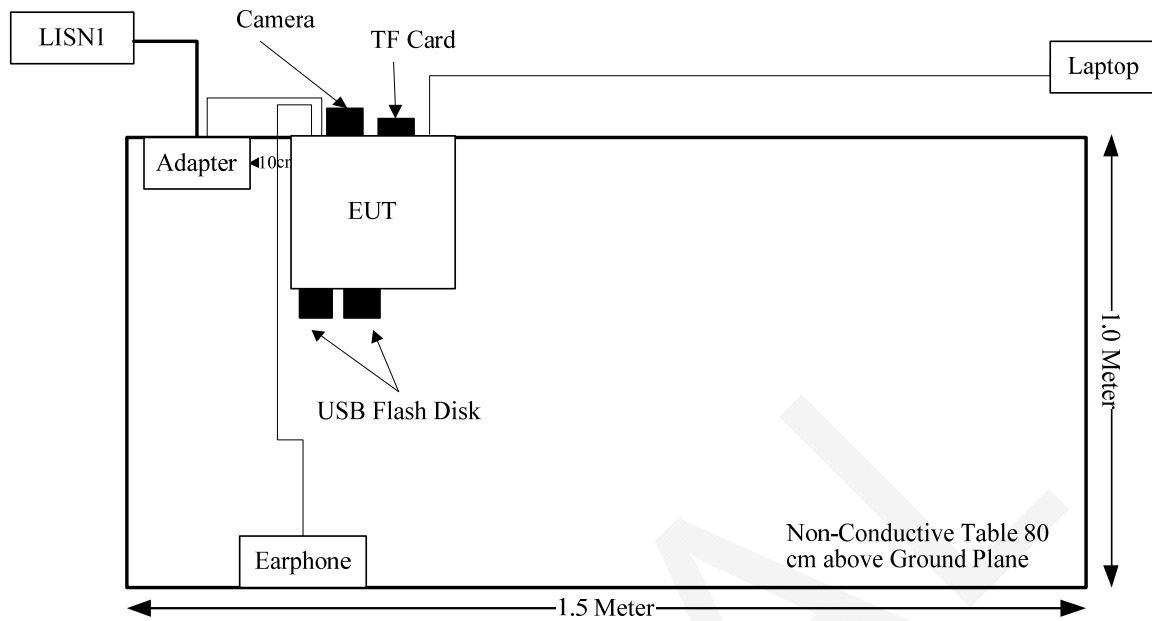

SUMMARY OF TEST RESULTS

FCC Rules	Description of Test	Result
FCC§15.247 (i) & §1.1310 & §2.1091	Maximum Permissible Exposure (MPE)	Compliance
§15.203	Antenna Requirement	Compliance
§15.207 (a)	AC Line Conducted Emissions	Compliance
§15.205, §15.209, §15.247(d)	Spurious Emissions	Compliance
§15.247 (a)(2)	6 dB Bandwidth	Compliance
§15.247(b)(3)	Maximum Conducted Output Power	Compliance
§15.247(d)	100 kHz Bandwidth of Frequency Band Edge	Compliance
§15.247(e)	Power Spectral Density	Compliance

FCC §15.247 (i) & §1.1310 & §2.1091- MAXIMUM PERMISSIBLE EXPOSURE (MPE)

Applicable Standard

According to subpart 15.247(i) and subpart §1.1310, systems operating under the provisions of this section shall be operated in a manner that ensures that the public is not exposed to radio frequency energy level in excess of the Commission's guidelines.

Limits for Maximum Permissible Exposure (MPE) (§1.1310, §2.1091)

(B) Limits for General Population/Uncontrolled Exposure				
Frequency Range (MHz)	Electric Field Strength (V/m)	Magnetic Field Strength (A/m)	Power Density (mW/cm ²)	Averaging Time (minutes)
0.3–1.34	614	1.63	*(100)	30
1.34–30	824/f	2.19/f	*(180/f ²)	30
30–300	27.5	0.073	0.2	30
300–1500	/	/	f/1500	30
1500–100,000	/	/	1.0	30

f = frequency in MHz; * = Plane-wave equivalent power density;

According to §1.1310 and §2.1091 RF exposure is calculated.

Calculation formula:

Prediction of power density at the distance of the applicable MPE limit

$S = PG/4\pi R^2$ = power density (in appropriate units, e.g. mW/cm²);

P = power input to the antenna (in appropriate units, e.g., mW);

G = power gain of the antenna in the direction of interest relative to an isotropic radiator, the power gain factor, is normally numeric gain;

R = distance to the center of radiation of the antenna (appropriate units, e.g., cm);

For simultaneously transmit system, the calculated power density should comply with:

$$\sum_i \frac{S_i}{S_{Limit,i}} \leq 1$$

Calculated Data:

Radio	Frequency (MHz)	Antenna Gain		Conducted output power including Tune-up Tolerance		Evaluation Distance (cm)	Power Density (mW/cm ²)	MPE Limit (mW/cm ²)
		(dBi)	(numeric)	(dBm)	(mW)			
Lora-DSS	903.3-914.9	3.5	2.24	19	79.43	20.00	0.035	0.60
Lora-DXX	923.3-927.5	3.5	2.24	-3	0.50	20.00	0.0002	0.62
BLE	2402-2480	3.5	2.24	-4	0.40	20.00	0.0002	1.0
WLAN 2.4G	2412-2462	3.5	2.24	15	31.62	20.00	0.0141	1.0
WLAN 5.8G	5725-5850	2.3	1.70	8	6.31	20.00	0.002	1.0

The WLAN 2.4G,5G or BLE can't transmit simultaneously, Wi-Fi/BLE can transmit simultaneously with Lora:

$$\sum_i \frac{S_i}{S_{Limit,i}}$$

$$=S_{WLAN}/S_{limit-WLAN} + S_{Lora}/S_{limit-Lora}$$

$$=0.0141/1 + 0.035/0.60$$

$$=0.072$$

$$< 1.0$$

Result: The device meet FCC MPE at 20 cm distance

FCC §15.203 - ANTENNA REQUIREMENT

Applicable Standard

According to § 15.203, an intentional radiator shall be designed to ensure that no antenna other than that furnished by the responsible party shall be used with the device. The use of a permanently attached antenna or of an antenna that uses a unique coupling to the intentional radiator shall be considered sufficient to comply with the provisions of this section. The manufacturer may design the unit so that a broken antenna can be replaced by the user, but the user of a standard antenna jack or electrical connector is prohibited. The structure and application of the EUT were analyzed to determine compliance with section §15.203 of the rules. §15.203 state that the subject device must meet the following criteria:

- a. Antenna must be permanently attached to the unit.
- b. Antenna must use a unique type of connector to attach to the EUT.
- c. Unit must be professionally installed, and installer shall be responsible for verifying that the correct antenna is employed with the unit.

Antenna Connector Construction

The EUT has one antenna arrangement for Wi-Fi/BLE use a unique type of connector to attach to the EUT. fulfill the requirement of this section. Please refer to the EUT photos.

Antenna Type	input impedance (Ohm)	Antenna Gain /Frequency Range
Dipole	50	3.5 dBi/2.4~2.5GHz 2.3 dBi/5.725~5.85 GHz

Result: Compliance.

FCC §15.207 (a) – AC LINE CONDUCTED EMISSIONS

Applicable Standard

FCC§15.207(a).

EUT Setup

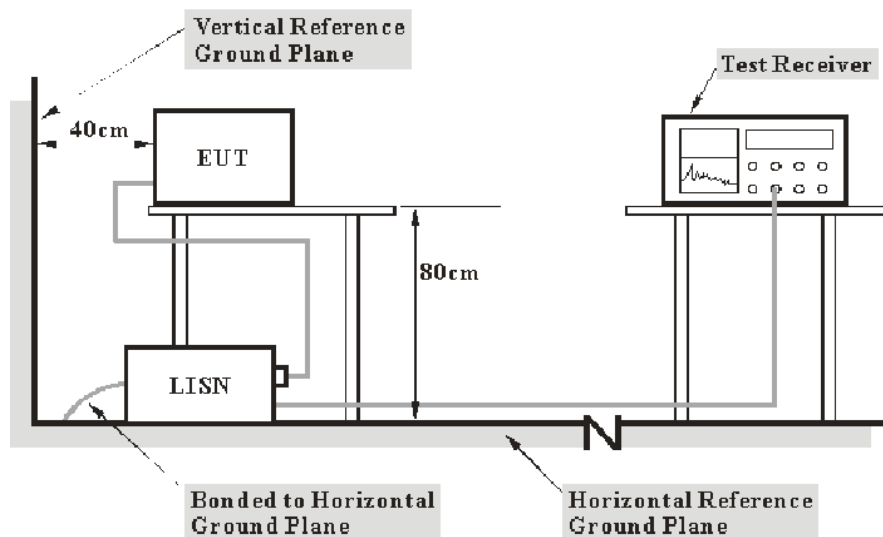

- Note: 1. Support units were connected to second LISN.
 2. Both of LISNs (AMN) 80 cm from EUT and at the least 80 cm from other units and other metal planes support units.

The setup of EUT is according with per ANSI C63.10-2013 measurement procedure. The specification used was with the FCC Part 15.207 limits.

The spacing between the peripherals was 10 cm.

The adapter was connected to the main LISN with a 120 V/60 Hz AC power source.

EMI Test Receiver Setup

The EMI test receiver was set to investigate the spectrum from 150 kHz to 30 MHz.

During the conducted emission test, the EMI test receiver was set with the following configurations:

Frequency Range	IF B/W
150 kHz – 30 MHz	9 kHz

Test Procedure

During the conducted emission test, the adapter was connected to the outlet of the first LISN.

The frequency and amplitude of the six highest ac power-line conducted emissions relative to the limit, measured over all the current-carrying conductors of the EUT power cords, and the operating frequency or frequency to which the EUT is tuned (if appropriate), should be reported, unless such emissions are more than 20 dB below the limit. AC power-line conducted emissions measurements are to be separately carried out only on each of the phase (“hot”) line(s) and (if used) on the neutral line(s), but not on the ground [protective earth] line(s). If less than six emission frequencies are within 20 dB of the limit, then the noise level of the measuring instrument at representative frequencies should be reported. The specific conductor of the power-line cord for each of the reported emissions should be identified. Measure the six highest emissions with respect to the limit on each current-carrying conductor of each power cord associated with the EUT (but not the power cords of associated or peripheral equipment that are part of the test configuration). Then, report the six highest emissions with respect to the limit from among all the measurements identifying the frequency and specific current-carrying conductor identified with the emission. The six highest emissions should be reported for each of the current-carrying conductors, or the six highest emissions may be reported over all the current-carrying conductors.

Corrected Amplitude & Margin Calculation

The basic equation is as follows:

$$V_C = V_R + A_C + VDF$$

$$C_f = A_C + VDF$$

Herein,

V_C (cord. Reading): corrected voltage amplitude

V_R : reading voltage amplitude

A_C : attenuation caused by cable loss

VDF: voltage division factor of AMN

C_f : Correction Factor

The “**Margin**” column of the following data tables indicates the degree of compliance within the applicable limit. For example, a margin of 7dB means the emission is 7dB below the limit. The equation for margin calculation is as follows:

$$\text{Margin} = \text{Limit} - \text{Corrected Amplitude}$$

Test Equipment List and Details

Manufacturer	Description	Model	Serial Number	Calibration Date	Calibration Due Date
R&S	LISN	ENV 216	101614	2020-09-12	2021-09-12
R&S	EMI Test Receiver	ESCI	101121	2021-07-06	2022-07-05
MICRO-COAX	Coaxial Cable	C-NJNJ-50	C-0200-01	2020-09-05	2021-09-05
R&S	Test Software	EMC32	Version 9.10.00	N/A	N/A

* **Statement of Traceability:** Bay Area Compliance Laboratories Corp. (Dongguan) attests that all calibrations have been performed, traceable to National Primary Standards and International System of Units (SI).

Test Data

Environmental Conditions

Temperature:	26°C
Relative Humidity:	52%
ATM Pressure:	100.3kPa
Tester:	Mia Huang
Test Date:	2021-07-19

Test Result: Compliance

Test Mode: Transmitting(802.11b mode high channel was the worst)

AC120 V, 60 Hz, Line:

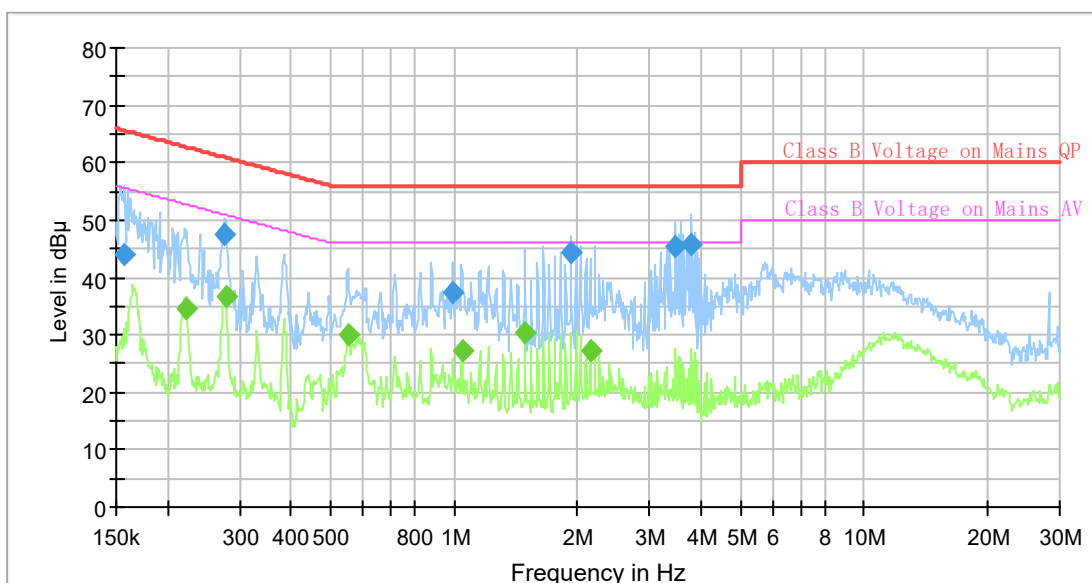

Final Result

Frequency (MHz)	QuasiPeak (dB µ V)	Average (dB µ V)	Limit (dB µ V)	Margin (dB)	Bandwidth (kHz)	Line	Corr. (dB)
0.157671	44.08	---	65.59	21.51	9.000	L1	9.6
0.221332	---	34.66	52.77	18.11	9.000	L1	9.6
0.275645	47.45	---	60.95	13.50	9.000	L1	9.6
0.277024	---	36.71	50.90	14.19	9.000	L1	9.6
0.551358	---	30.15	46.00	15.85	9.000	L1	9.6
0.993182	37.39	---	56.00	18.61	9.000	L1	9.7
1.049193	---	27.25	46.00	18.75	9.000	L1	9.7
1.487578	---	30.55	46.00	15.45	9.000	L1	9.7
1.928035	44.29	---	56.00	11.71	9.000	L1	9.7
2.151633	---	27.41	46.00	18.59	9.000	L1	9.7
3.473043	45.31	---	56.00	10.69	9.000	L1	9.7
3.799262	45.68	---	56.00	10.32	9.000	L1	9.7

AC120 V, 60 Hz, Neutral:

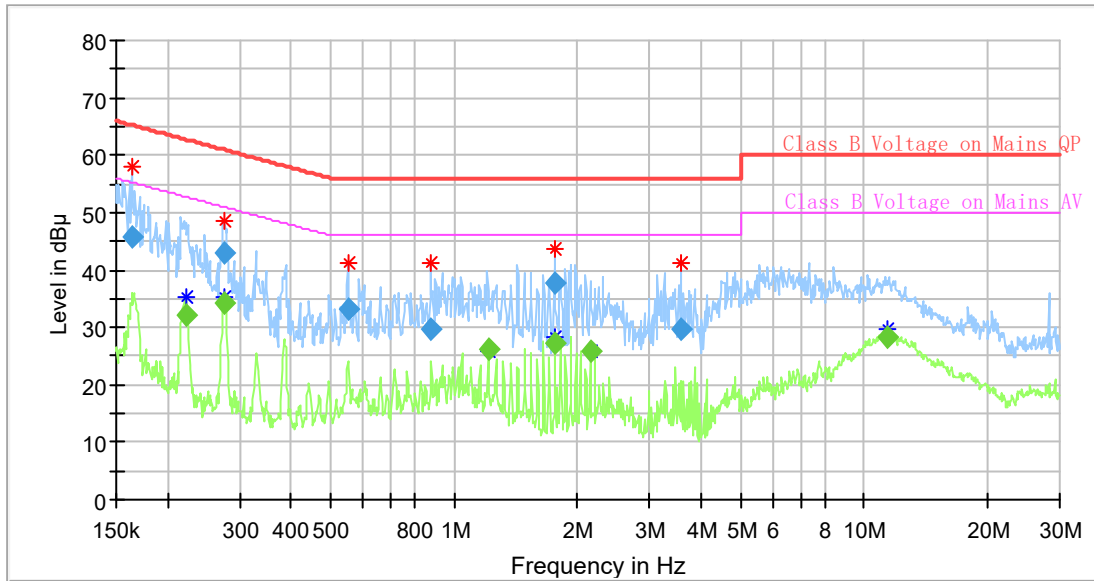

Final Result

Frequency (MHz)	QuasiPeak (dB µV)	Average (dB µV)	Limit (dB µV)	Margin (dB)	Bandwidth (kHz)	Line	Corr. (dB)
0.163273	45.73	---	65.30	19.57	9.000	N	9.6
0.221332	---	32.24	52.77	20.53	9.000	N	9.6
0.274274	42.95	---	60.99	18.04	9.000	N	9.6
0.275645	---	34.39	50.95	16.56	9.000	N	9.6
0.551358	33.14	---	56.00	22.86	9.000	N	9.6
0.876753	29.68	---	56.00	26.32	9.000	N	9.6
1.212470	---	26.17	46.00	19.83	9.000	N	9.6
1.762486	---	27.11	46.00	18.89	9.000	N	9.6
1.762486	37.86	---	56.00	18.14	9.000	N	9.6
2.151633	---	25.77	46.00	20.23	9.000	N	9.6
3.578545	29.79	---	56.00	26.21	9.000	N	9.6
11.382374	---	28.22	50.00	21.78	9.000	N	9.7

FCC §15.209, §15.205 & §15.247(d) - SPURIOUS EMISSIONS

Applicable Standard

FCC §15.247 (d); §15.209; §15.205;

EUT Setup

Below 1GHz:

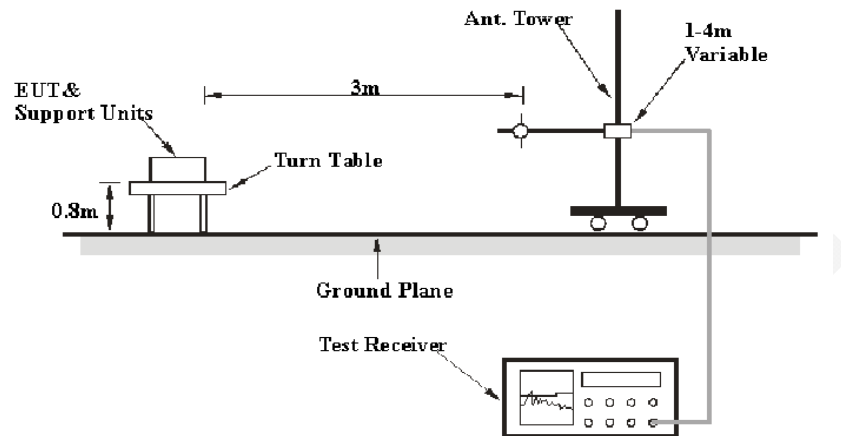

Above 1GHz:

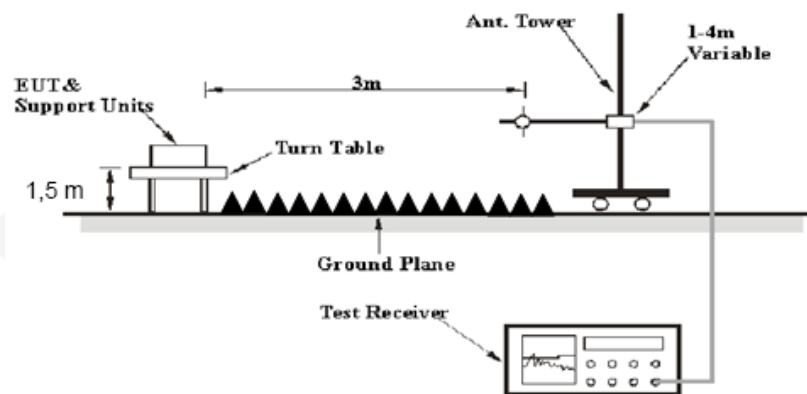

The radiated emission below 1GHz tests were performed in the 10 meters chamber, above 1GHz tests were performed in the 3 meters chamber test site B, using the setup accordance with the ANSI C63.10-2013. The specification used was the FCC 15.209, and FCC 15.247 limits.

The external I/O cables were draped along the test table and formed a bundle 30 to 40 cm long in the middle.

The spacing between the peripherals was 10 cm.

EMI Test Receiver & Spectrum Analyzer Setup

The system was investigated from 30 MHz to 25 GHz.

During the radiated emission test, the EMI test receiver & Spectrum Analyzer Setup were set with the following configurations:

30MHz-1000MHz:

Measurement	RBW	Video B/W	IF B/W
QP	120 kHz	300 kHz	120kHz

1GHz- 25GHz:

Measurement	Duty cycle	RBW	Video B/W
PK	Any	1MHz	3 MHz
AV	>98%	1MHz	10 Hz
	<98%	1MHz	1/T

Note: T is minimum transmission duration

If the maximized peak measured value complies with under the QP/Average limit more than 6dB, then it is unnecessary to perform an QP/Average measurement.

Test Procedure

Maximizing procedure was performed on the highest emissions to ensure that the EUT complied with all installation combinations.

Data was recorded in Quasi-peak detection mode for frequency range of 30 MHz-1 GHz, peak and Average detection modes for frequencies above 1 GHz.

Corrected Amplitude & Margin Calculation

The Corrected Amplitude is calculated by adding the Antenna Factor and Cable Loss, and subtracting the Amplifier Gain from the Meter Reading. The basic equation is as follows:

$$\text{Corrected Amplitude} = \text{Meter Reading} + \text{Antenna Factor} + \text{Cable Loss} - \text{Amplifier Gain}$$

The “**Margin**” column of the following data tables indicates the degree of compliance with the applicable limit. For example, a margin of 7dB means the emission is 7dB below the limit. The equation for margin calculation is as follows:

$$\text{Margin} = \text{Limit} - \text{Corrected Amplitude}$$

Test Equipment List and Details

Manufacturer	Description	Model	Serial Number	Calibration Date	Calibration Due Date
Radiation Below 1GHz					
Sunol Sciences	Antenna	JB3	A060611-2	2020-08-25	2023-08-25
R&S	EMI Test Receiver	ESCI	100224	2020-09-12	2021-09-12
Unknown	Coaxial Cable	C-NJNJ-50	C-1000-01	2020-09-05	2021-09-05
Unknown	Coaxial Cable	C-NJNJ-50	C-0400-02	2020-09-05	2021-09-05
Unknown	Coaxial Cable	C-NJNJ-50	C-0530-01	2020-09-24	2021-09-24
Sonoma	Amplifier	310N	185914	2020-10-13	2021-10-13
Farad	Test Software	EZ-EMC	V1.1.4.2	N/A	N/A
Radiation Above 1GHz					
Agilent	Spectrum Analyzer	E4440A	SG43360054	2021-07-06	2022-07-05
Unknown	Coaxial Cable	C-SJSJ-50	C-0800-01	2020-09-05	2021-09-05
Unknown	Coaxial Cable	C-2.4J2.4J-50	C-0700-02	2021-06-27	2022-06-26
Mini-Circuit	Amplifier	ZVA-213-S+	54201245	2020-09-05	2021-09-05
Quinstar	Amplifier	QLW-18405536-JO	15964001001	2021-06-27	2022-06-26
Farad	Test Software	EZ-EMC	V1.1.4.2	N/A	N/A
E-Microwave	Band-stop Filters	OBSF-2400-2483.5-S	OE01601525	2021-06-16	2022-06-15
Mini Circuits	High Pass Filter	VHF-6010+	31118	2021-06-16	2022-06-15

* **Statement of Traceability:** Bay Area Compliance Laboratories Corp. (Dongguan) attests that all calibrations have been performed, traceable to National Primary Standards and International System of Units (SI).

Test Data**Environmental Conditions**

Test Items	Radiation Below 1GHz	Radiation Above 1GHz
Temperature:	26.2°C	26.8°C
Relative Humidity:	60%	36 %
ATM Pressure:	100.3kPa	100.3kPa
Tester:	Burt Hu	Jeremy Liang
Test Date:	2021-07-19	2021-07-21

Test Result: Compliance, please Refer to the following data

Test Mode: Transmitting

1) 30MHz-1GHz(802.11b_High channel was the worst)

Horizontal:

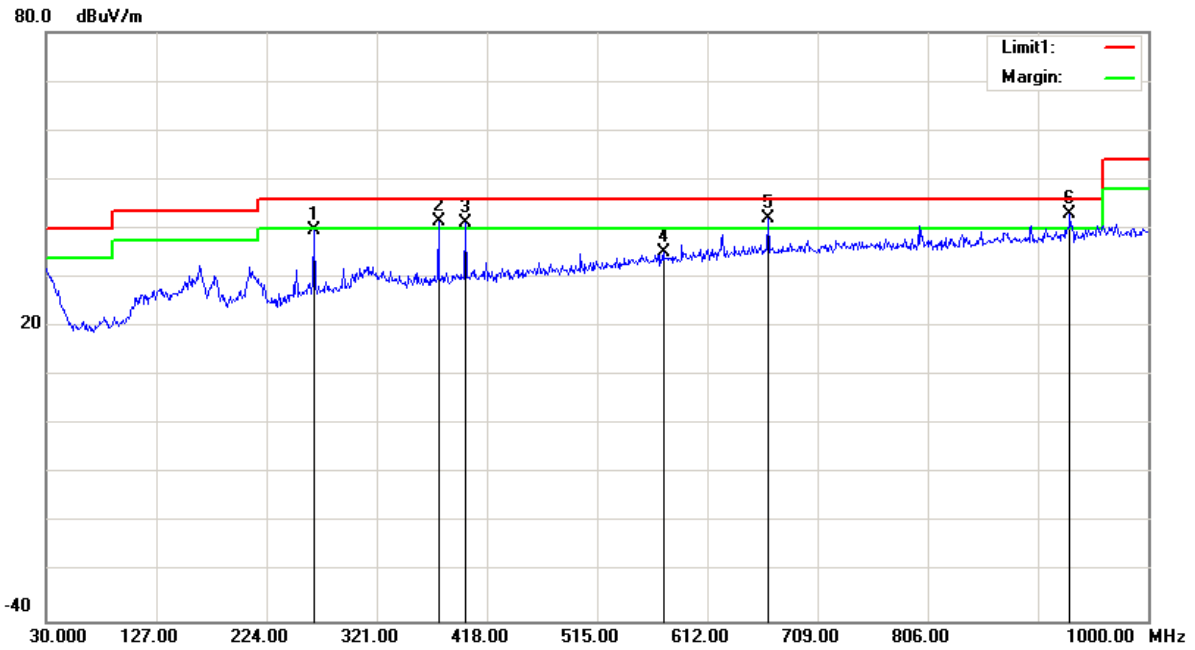

Frequency (MHz)	Receiver Reading (dBuV)	Detector	Correction Factor (dB/m)	Cord. Amp. (dBuV/m)	Limit (dBuV/m)	Margin (dB)
265.7100	17.85	peak	21.83	39.68	46.00	6.32
375.3200	16.69	QP	24.81	41.50	46.00	4.50
398.6000	15.87	QP	25.43	41.30	46.00	4.70
573.2000	5.99	peak	29.10	35.09	46.00	10.91
665.3500	11.73	QP	30.37	42.10	46.00	3.90
931.1300	9.30	QP	33.70	43.00	46.00	3.00

Vertical:

80.0 dBuV/m

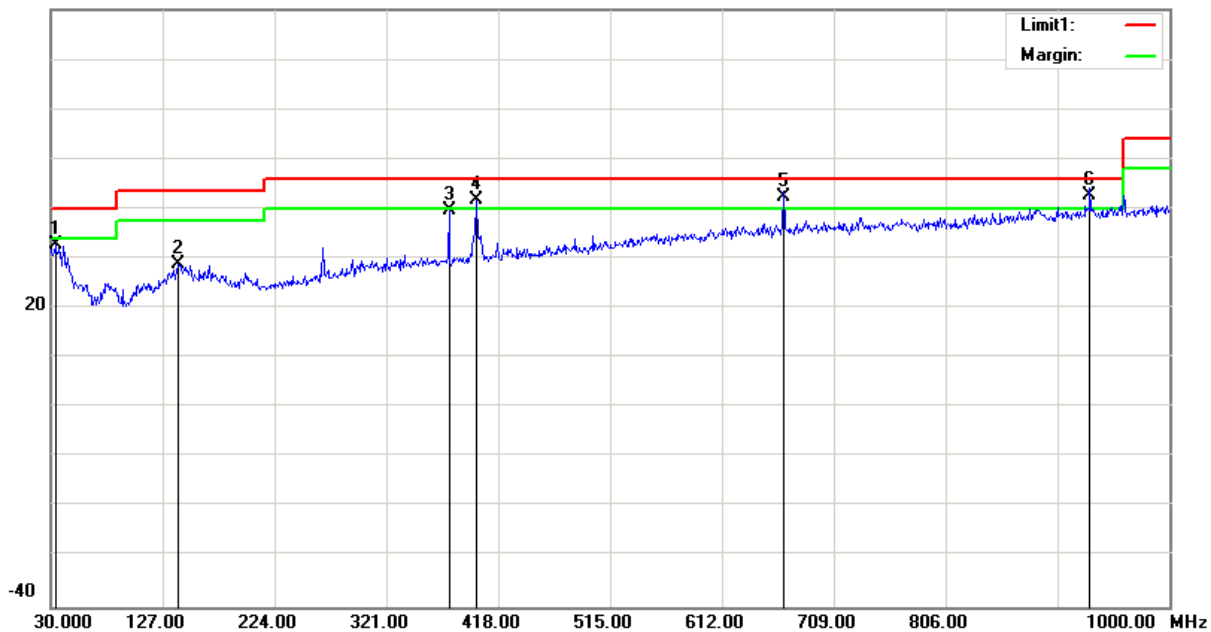

Frequency (MHz)	Receiver Reading (dBuV)	Detector	Correction Factor (dB/m)	Cord. Amp. (dBuV/m)	Limit (dBuV/m)	Margin (dB)
33.8800	7.77	peak	24.84	32.61	40.00	7.39
140.5800	7.13	peak	21.63	28.76	43.50	14.74
375.3200	14.70	peak	24.81	39.51	46.00	6.49
399.5700	16.44	QP	25.46	41.90	46.00	4.10
665.3500	11.93	QP	30.37	42.30	46.00	3.70
931.1300	8.90	QP	33.70	42.60	46.00	3.40

**2) 1-25GHz:
802.11b Mode:**

Frequency (MHz)	Receiver		Rx Antenna		Cable loss (dB)	Amplifier Gain (dB)	Corrected Amplitude (dB μ V/m)	Limit (dB μ V/m)	Margin (dB)
	Reading (dB μ V)	Detector	Polar (H/V)	Factor (dB/m)					
Low Channel: 2412 MHz									
2412.00	67.82	PK	H	28.12	1.81	0.00	97.75	N/A	N/A
2412.00	64.97	AV	H	28.12	1.81	0.00	94.90	N/A	N/A
2412.00	58.50	PK	V	28.12	1.81	0.00	88.43	N/A	N/A
2412.00	55.26	AV	V	28.12	1.81	0.00	85.19	N/A	N/A
2390.00	26.35	PK	H	28.08	1.80	0.00	56.23	74.00	17.77
2390.00	14.56	AV	H	28.08	1.80	0.00	44.44	54.00	9.56
4824.00	34.26	PK	H	32.95	3.19	25.62	44.78	74.00	29.22
4824.00	22.59	AV	H	32.95	3.19	25.62	33.11	54.00	20.89
7236.00	34.61	PK	H	35.81	4.77	25.64	49.55	74.00	24.45
7236.00	22.95	AV	H	35.81	4.77	25.64	37.89	54.00	16.11
Middle Channel: 2437 MHz									
2437.00	68.89	PK	H	28.17	1.82	0.00	98.88	N/A	N/A
2437.00	65.95	AV	H	28.17	1.82	0.00	95.94	N/A	N/A
2437.00	58.34	PK	V	28.17	1.82	0.00	88.33	N/A	N/A
2437.00	55.09	AV	V	28.17	1.82	0.00	85.08	N/A	N/A
4874.00	33.95	PK	H	33.05	3.26	25.65	44.61	74.00	29.39
4874.00	21.56	AV	H	33.05	3.26	25.65	32.22	54.00	21.78
7311.00	34.28	PK	H	36.01	4.64	25.71	49.22	74.00	24.78
7311.00	22.73	AV	H	36.01	4.64	25.71	37.67	54.00	16.33
High Channel: 2462 MHz									
2462.00	68.94	PK	H	28.22	1.83	0.00	98.99	N/A	N/A
2462.00	65.84	AV	H	28.22	1.83	0.00	95.89	N/A	N/A
2462.00	57.26	PK	V	28.22	1.83	0.00	87.31	N/A	N/A
2462.00	54.31	AV	V	28.22	1.83	0.00	84.36	N/A	N/A
2483.50	26.52	PK	H	28.27	1.84	0.00	56.63	74.00	17.37
2483.50	14.23	AV	H	28.27	1.84	0.00	44.34	54.00	9.66
4924.00	34.26	PK	H	33.15	3.27	25.65	45.03	74.00	28.97
4924.00	22.16	AV	H	33.15	3.27	25.65	32.93	54.00	21.07
7386.00	34.18	PK	H	36.20	4.51	25.79	49.10	74.00	24.90
7386.00	22.03	AV	H	36.20	4.51	25.79	36.95	54.00	17.05

802.11g Mode:

Frequency (MHz)	Receiver		Rx Antenna		Cable loss (dB)	Amplifier Gain (dB)	Corrected Amplitude (dBµV/m)	Limit (dBµV/m)	Margin (dB)
	Reading (dBµV)	Detector	Polar (H/V)	Factor (dB/m)					
Low Channel: 2412 MHz									
2412.00	71.05	PK	H	28.12	1.81	0.00	100.98	N/A	N/A
2412.00	62.12	AV	H	28.12	1.81	0.00	92.05	N/A	N/A
2412.00	62.71	PK	V	28.12	1.81	0.00	92.64	N/A	N/A
2412.00	53.16	AV	V	28.12	1.81	0.00	83.09	N/A	N/A
2390.00	31.89	PK	H	28.08	1.80	0.00	61.77	74.00	12.23
2390.00	14.56	AV	H	28.08	1.80	0.00	44.44	54.00	9.56
4824.00	34.26	PK	H	32.95	3.19	25.62	44.78	74.00	29.22
4824.00	22.25	AV	H	32.95	3.19	25.62	32.77	54.00	21.23
7236.00	34.15	PK	H	35.81	4.77	25.64	49.09	74.00	24.91
7236.00	22.16	AV	H	35.81	4.77	25.64	37.10	54.00	16.90
Middle Channel: 2437 MHz									
2437.00	71.36	PK	H	28.17	1.82	0.00	101.35	N/A	N/A
2437.00	62.13	AV	H	28.17	1.82	0.00	92.12	N/A	N/A
2437.00	62.85	PK	V	28.17	1.82	0.00	92.84	N/A	N/A
2437.00	53.58	AV	V	28.17	1.82	0.00	83.57	N/A	N/A
4874.00	34.26	PK	H	33.05	3.26	25.65	44.92	74.00	29.08
4874.00	22.18	AV	H	33.05	3.26	25.65	32.84	54.00	21.16
7311.00	34.63	PK	H	36.01	4.64	25.71	49.57	74.00	24.43
7311.00	22.13	AV	H	36.01	4.64	25.71	37.07	54.00	16.93
High Channel: 2462 MHz									
2462.00	73.41	PK	H	28.22	1.83	0.00	103.46	N/A	N/A
2462.00	64.62	AV	H	28.22	1.83	0.00	94.67	N/A	N/A
2462.00	64.25	PK	V	28.22	1.83	0.00	94.30	N/A	N/A
2462.00	55.47	AV	V	28.22	1.83	0.00	85.52	N/A	N/A
2483.50	32.71	PK	H	28.27	1.84	0.00	62.82	74.00	11.18
2483.50	15.81	AV	H	28.27	1.84	0.00	45.92	54.00	8.08
4924.00	34.26	PK	H	33.15	3.27	25.65	45.03	74.00	28.97
4924.00	22.19	AV	H	33.15	3.27	25.65	32.96	54.00	21.04
7386.00	34.62	PK	H	36.20	4.51	25.79	49.54	74.00	24.46
7386.00	22.52	AV	H	36.20	4.51	25.79	37.44	54.00	16.56

802.11n ht20 Mode:

Frequency (MHz)	Receiver		Rx Antenna		Cable loss (dB)	Amplifier Gain (dB)	Corrected Amplitude (dB μ V/m)	Limit (dB μ V/m)	Margin (dB)
	Reading (dB μ V)	Detector	Polar (H/V)	Factor (dB/m)					
Low Channel: 2412 MHz									
2412.00	70.73	PK	H	28.12	1.81	0.00	100.66	N/A	N/A
2412.00	61.55	AV	H	28.12	1.81	0.00	91.48	N/A	N/A
2412.00	62.57	PK	V	28.12	1.81	0.00	92.50	N/A	N/A
2412.00	52.33	AV	V	28.12	1.81	0.00	82.26	N/A	N/A
2390.00	27.66	PK	H	28.08	1.80	0.00	57.54	74.00	16.46
2390.00	14.23	AV	H	28.08	1.80	0.00	44.11	54.00	9.89
4824.00	34.26	PK	H	32.95	3.19	25.62	44.78	74.00	29.22
4824.00	22.15	AV	H	32.95	3.19	25.62	32.67	54.00	21.33
7236.00	34.85	PK	H	35.81	4.77	25.64	49.79	74.00	24.21
7236.00	22.54	AV	H	35.81	4.77	25.64	37.48	54.00	16.52
Middle Channel: 2437 MHz									
2437.00	70.48	PK	H	28.17	1.82	0.00	100.47	N/A	N/A
2437.00	61.54	AV	H	28.17	1.82	0.00	91.53	N/A	N/A
2437.00	59.84	PK	V	28.17	1.82	0.00	89.83	N/A	N/A
2437.00	50.63	AV	V	28.17	1.82	0.00	80.62	N/A	N/A
4874.00	34.26	PK	H	33.05	3.26	25.65	44.92	74.00	29.08
4874.00	22.15	AV	H	33.05	3.26	25.65	32.81	54.00	21.19
7311.00	34.63	PK	H	36.01	4.64	25.71	49.57	74.00	24.43
7311.00	22.51	AV	H	36.01	4.64	25.71	37.45	54.00	16.55
High Channel: 2462 MHz									
2462.00	72.93	PK	H	28.22	1.83	0.00	102.98	N/A	N/A
2462.00	63.55	AV	H	28.22	1.83	0.00	93.60	N/A	N/A
2462.00	61.23	PK	V	28.22	1.83	0.00	91.28	N/A	N/A
2462.00	52.36	AV	V	28.22	1.83	0.00	82.41	N/A	N/A
2483.50	32.14	PK	H	28.27	1.84	0.00	62.25	74.00	11.75
2483.50	14.86	AV	H	28.27	1.84	0.00	44.97	54.00	9.03
4924.00	34.25	PK	H	33.15	3.27	25.65	45.02	74.00	28.98
4924.00	22.65	AV	H	33.15	3.27	25.65	33.42	54.00	20.58
7386.00	34.62	PK	H	36.20	4.51	25.79	49.54	74.00	24.46
7386.00	22.78	AV	H	36.20	4.51	25.79	37.70	54.00	16.30

802.11n ht40 Mode:

Frequency (MHz)	Receiver		Rx Antenna		Cable loss (dB)	Amplifier Gain (dB)	Corrected Amplitude (dB μ V/m)	Limit (dB μ V/m)	Margin (dB)
	Reading (dB μ V)	Detector	Polar (H/V)	Factor (dB/m)					
Low Channel: 2422 MHz									
2422.00	67.71	PK	H	28.14	1.81	0.00	97.66	N/A	N/A
2422.00	57.63	AV	H	28.14	1.81	0.00	87.58	N/A	N/A
2422.00	57.25	PK	V	28.14	1.81	0.00	87.20	N/A	N/A
2422.00	47.61	AV	V	28.14	1.81	0.00	77.56	N/A	N/A
2390.00	29.05	PK	H	28.08	1.80	0.00	58.93	74.00	15.07
2390.00	15.36	AV	H	28.08	1.80	0.00	45.24	54.00	8.76
4844.00	34.26	PK	H	32.99	3.22	25.63	44.84	74.00	29.16
4844.00	22.15	AV	H	32.99	3.22	25.63	32.73	54.00	21.27
7266.00	34.85	PK	H	35.89	4.72	25.67	49.79	74.00	24.21
7266.00	22.56	AV	H	35.89	4.72	25.67	37.50	54.00	16.50
Middle Channel: 2437 MHz									
2437.00	68.53	PK	H	28.17	1.82	0.00	98.52	N/A	N/A
2437.00	58.75	AV	H	28.17	1.82	0.00	88.74	N/A	N/A
2437.00	58.55	PK	V	28.17	1.82	0.00	88.54	N/A	N/A
2437.00	48.13	AV	V	28.17	1.82	0.00	78.12	N/A	N/A
4874.00	34.26	PK	H	33.05	3.26	25.65	44.92	74.00	29.08
4874.00	22.15	AV	H	33.05	3.26	25.65	32.81	54.00	21.19
7311.00	34.68	PK	H	36.01	4.64	25.71	49.62	74.00	24.38
7311.00	22.41	AV	H	36.01	4.64	25.71	37.35	54.00	16.65
High Channel: 2452 MHz									
2452.00	68.19	PK	H	28.20	1.83	0.00	98.22	N/A	N/A
2452.00	59.52	AV	H	28.20	1.83	0.00	89.55	N/A	N/A
2452.00	58.79	PK	V	28.20	1.83	0.00	88.82	N/A	N/A
2452.00	49.01	AV	V	28.20	1.83	0.00	79.04	N/A	N/A
2483.50	30.28	PK	H	28.27	1.84	0.00	60.39	74.00	13.61
2483.50	17.23	AV	H	28.27	1.84	0.00	47.34	54.00	6.66
4904.00	34.26	PK	H	33.11	3.30	25.67	45.00	74.00	29.00
4904.00	22.15	AV	H	33.11	3.30	25.67	32.89	54.00	21.11
7356.00	34.86	PK	H	36.13	4.56	25.76	49.79	74.00	24.21
7356.00	22.74	AV	H	36.13	4.56	25.76	37.67	54.00	16.33

BLE Mode:

Frequency (MHz)	Receiver		Rx Antenna		Cable loss (dB)	Amplifier Gain (dB)	Corrected Amplitude (dBµV/m)	Limit (dBµV/m)	Margin (dB)
	Reading (dBµV)	Detector (PK/QP/AV)	Polar (H/V)	Factor (dB/m)					
Low Channel: 2402 MHz									
2402.00	60.84	PK	H	28.10	1.80	0.00	90.74	N/A	N/A
2402.00	59.67	AV	H	28.10	1.80	0.00	89.57	N/A	N/A
2402.00	56.15	PK	V	28.10	1.80	0.00	86.05	N/A	N/A
2402.00	54.64	AV	V	28.10	1.80	0.00	84.54	N/A	N/A
2390.00	26.35	PK	H	28.08	1.80	0.00	56.23	74.00	17.77
2390.00	14.85	AV	H	28.08	1.80	0.00	44.73	54.00	9.27
4804.00	34.15	PK	H	32.91	3.17	25.60	44.63	74.00	29.37
4804.00	22.16	AV	H	32.91	3.17	25.60	32.64	54.00	21.36
7206.00	34.37	PK	H	35.74	4.82	25.60	49.33	74.00	24.67
7206.00	22.69	AV	H	35.74	4.82	25.60	37.65	54.00	16.35
Middle Channel: 2440 MHz									
2440.00	59.57	PK	H	28.18	1.82	0.00	89.57	N/A	N/A
2440.00	58.72	AV	H	28.18	1.82	0.00	88.72	N/A	N/A
2440.00	55.26	PK	V	28.18	1.82	0.00	85.26	N/A	N/A
2440.00	53.24	AV	V	28.18	1.82	0.00	83.24	N/A	N/A
4880.00	34.25	PK	H	33.06	3.27	25.66	44.92	74.00	29.08
4880.00	22.16	AV	H	33.06	3.27	25.66	32.83	54.00	21.17
7320.00	34.63	PK	H	36.03	4.62	25.72	49.56	74.00	24.44
7320.00	22.68	AV	H	36.03	4.62	25.72	37.61	54.00	16.39
High Channel: 2480 MHz									
2480.00	57.91	PK	H	28.26	1.84	0.00	88.01	N/A	N/A
2480.00	56.95	AV	H	28.26	1.84	0.00	87.05	N/A	N/A
2480.00	53.42	PK	V	28.26	1.84	0.00	83.52	N/A	N/A
2480.00	52.04	AV	V	28.26	1.84	0.00	82.14	N/A	N/A
2483.50	26.35	PK	H	28.27	1.84	0.00	56.46	74.00	17.54
2483.50	14.95	AV	H	28.27	1.84	0.00	45.06	54.00	8.94
4960.00	34.62	PK	H	33.22	3.23	25.63	45.44	74.00	28.56
4960.00	22.96	AV	H	33.22	3.23	25.63	33.78	54.00	20.22
7440.00	34.52	PK	H	36.34	4.41	25.85	49.42	74.00	24.58
7440.00	22.58	AV	H	36.34	4.41	25.85	37.48	54.00	16.52

Test plots(802.11b High channel was the worst)

Horizontal:

Fundamental Test with Band Rejection Filter

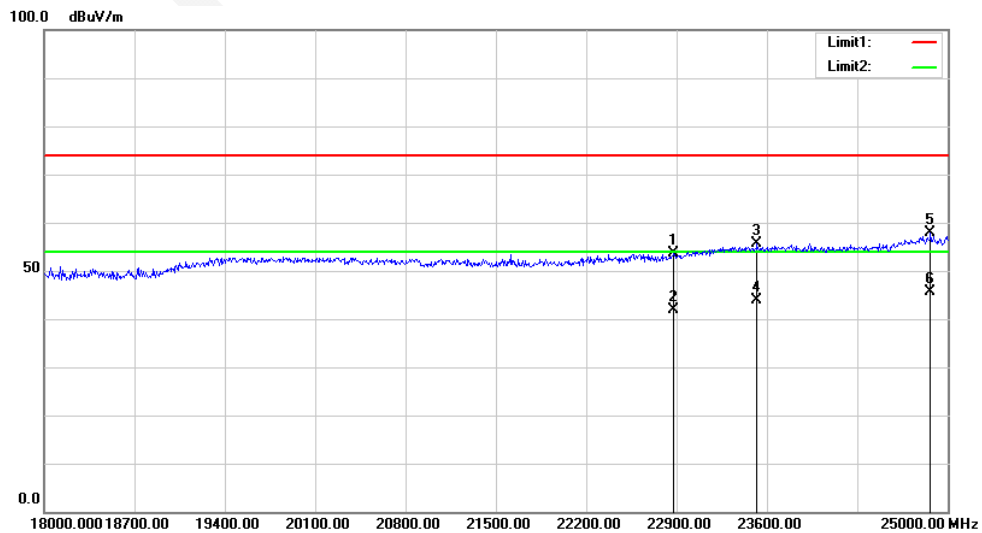
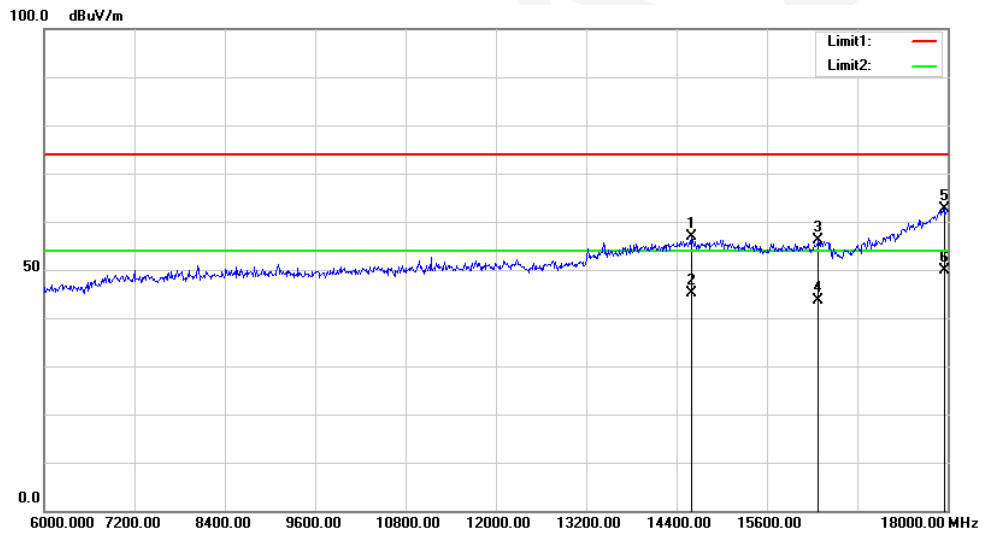
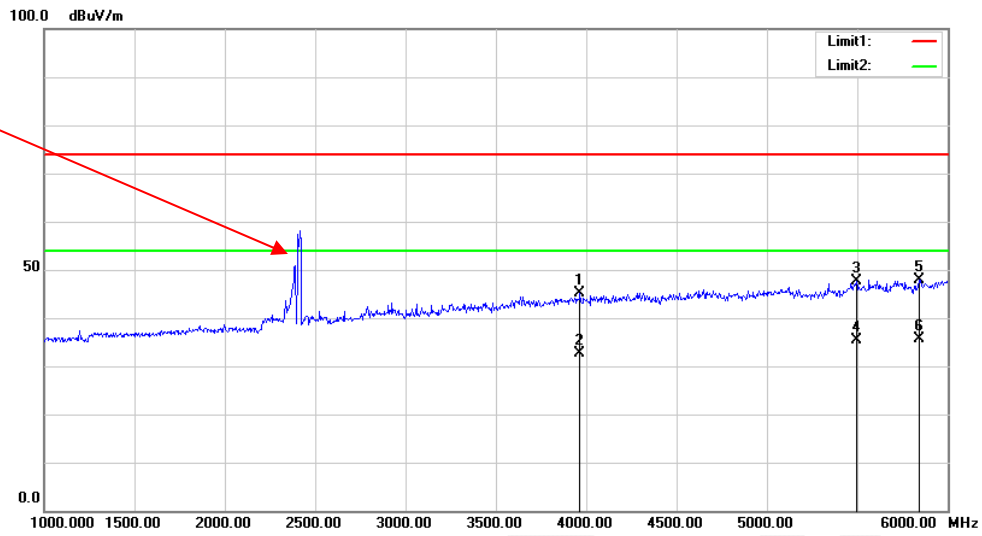

Vertical:

Fundamental
Test with Band
Rejection Filter

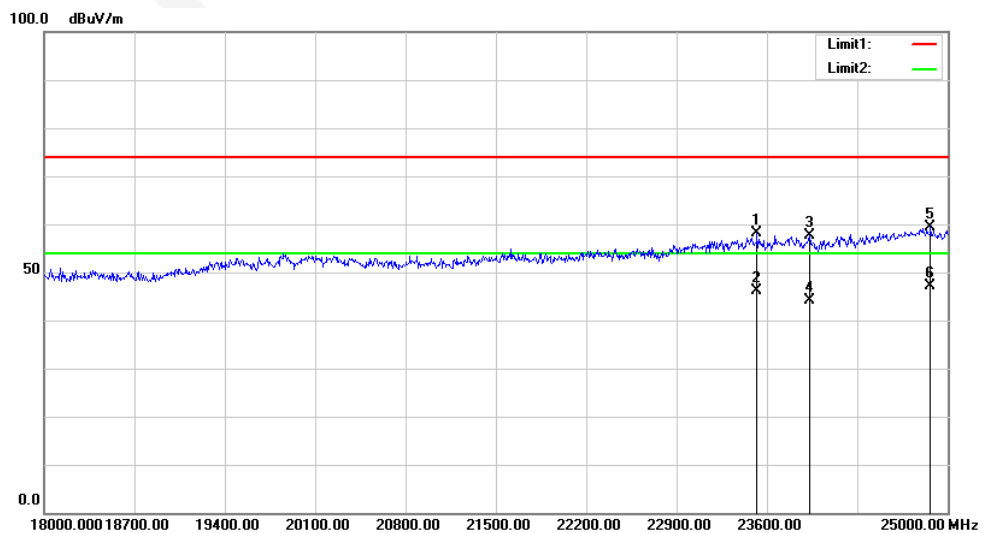
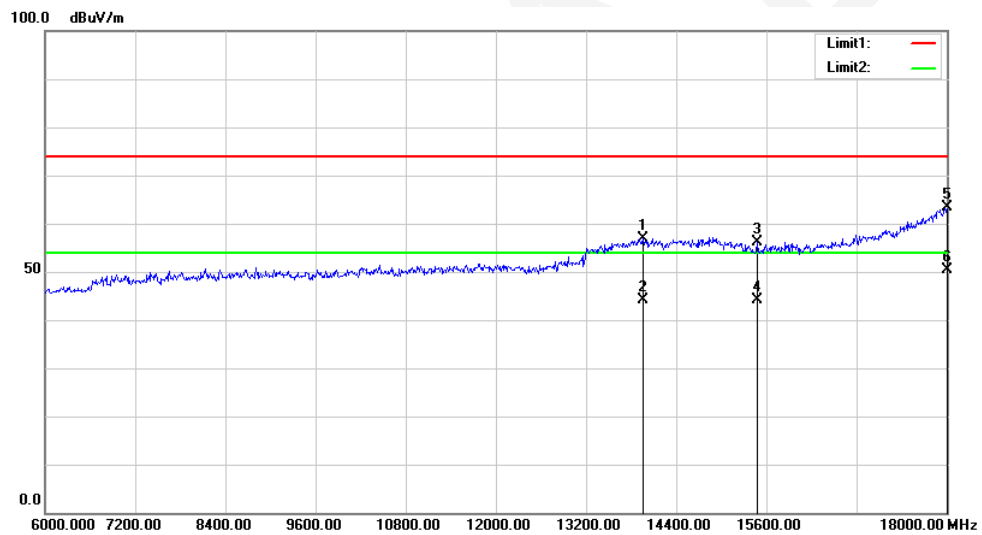
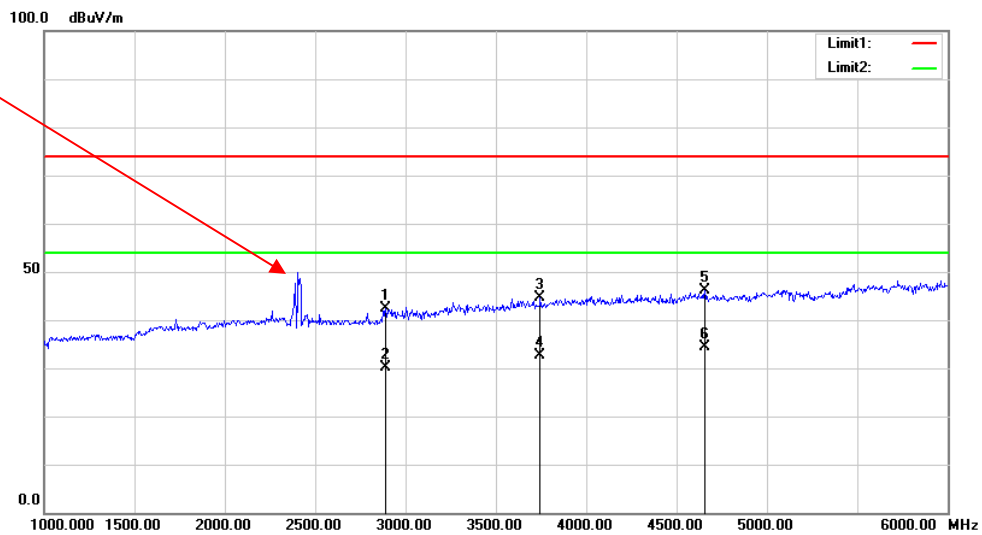

FCC §15.247(a) (2)–6 dB EMISSION BANDWIDTH

Applicable Standard

According to FCC §15.247(a) (2)

Systems using digital modulation techniques may operate in the 902–928 MHz, 2400–2483.5 MHz, and 5725–5850 MHz bands. The minimum 6 dB bandwidth shall be at least 500 kHz.

Test Procedure

- a) Set RBW = 100 kHz.
- b) Set the video bandwidth (VBW) $\geq 3 \times$ RBW.
- c) Detector = Peak.
- d) Trace mode = max hold.
- e) Sweep = auto couple.
- f) Allow the trace to stabilize.
- g) Measure the maximum width of the emission that is constrained by the frequencies associated with the two outermost amplitude points (upper and lower frequencies) that are attenuated by 6 dB relative to the maximum level measured in the fundamental emission.



Test Equipment List and Details

Manufacturer	Description	Model	Serial Number	Calibration Date	Calibration Due Date
R&S	EMI Test Receiver	ESR3	102724	2021-06-21	2022-06-20
E-Microwave	Coaxial Attenuators	EMCA20-2RN-2	OE0120328	Each time	N/A
Unknown	Coaxial Cable	C-SJ00-0010	C0010/01	Each time	N/A

* **Statement of Traceability:** Bay Area Compliance Laboratories Corp. (Dongguan) attests that all calibrations have been performed, traceable to National Primary Standards and International System of Units (SI).

Test Data

Environmental Conditions

Temperature:	27.2~27.5°C
Relative Humidity:	48~56 %
ATM Pressure:	100.5~101.1kPa
Test by:	Wayne Wei
Test Date:	2021-07-09~2021-07-10

Test Mode: Transmitting

Test Result: Compliance. Please refer to the following table and plots.

Test mode	Channel	Frequency (MHz)	6 dB Emission Bandwidth (MHz)	Limit (MHz)
802.11b	Low	2412	8.640	≥ 0.5
	Middle	2437	8.640	≥ 0.5
	High	2462	8.640	≥ 0.5
802.11g	Low	2412	15.920	≥ 0.5
	Middle	2437	16.240	≥ 0.5
	High	2462	15.360	≥ 0.5
802.11n ht20	Low	2412	17.520	≥ 0.5
	Middle	2437	17.120	≥ 0.5
	High	2462	15.520	≥ 0.5
802.11n ht40	Low	2422	35.840	≥ 0.5
	Middle	2437	36.000	≥ 0.5
	High	2452	36.000	≥ 0.5
BLE	Low	2402	0.712	≥ 0.5
	Middle	2440	0.716	≥ 0.5
	High	2480	0.716	≥ 0.5

802.11b Low Channel

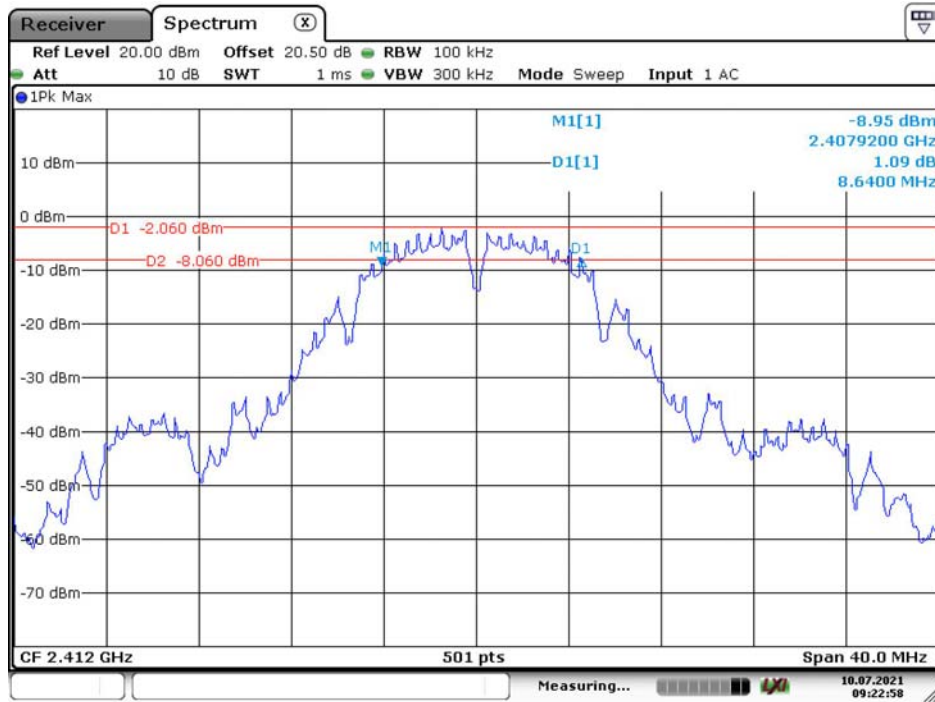

Date: 10.JUL.2021 09:22:58

802.11b Middle Channel

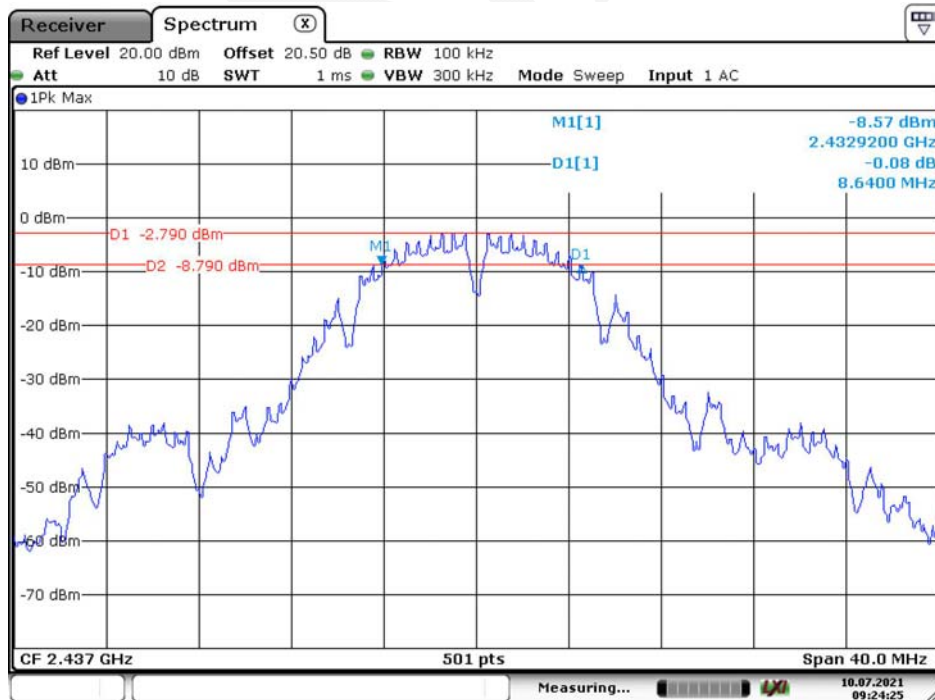

Date: 10.JUL.2021 09:24:25

802.11b High Channel

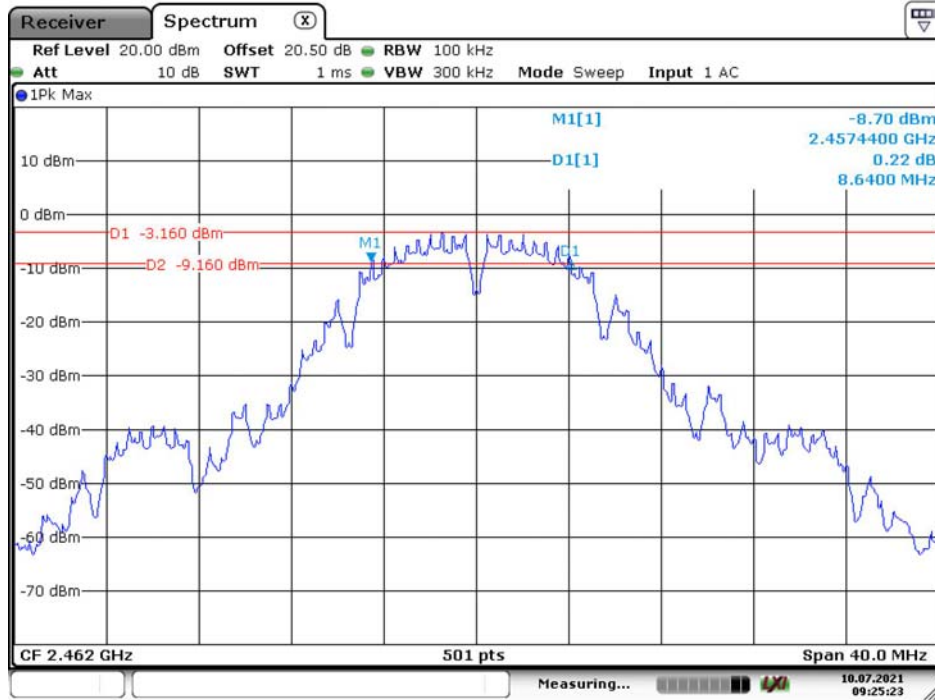

Date: 10.JUL.2021 09:25:23

802.11g Low Channel

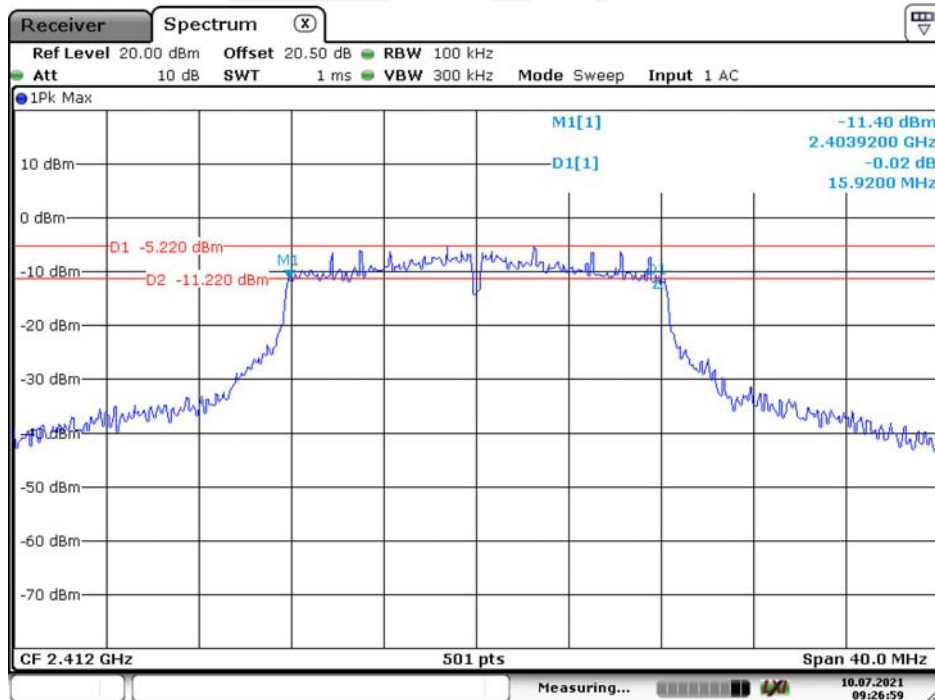

Date: 10.JUL.2021 09:26:59

802.11g Middle Channel

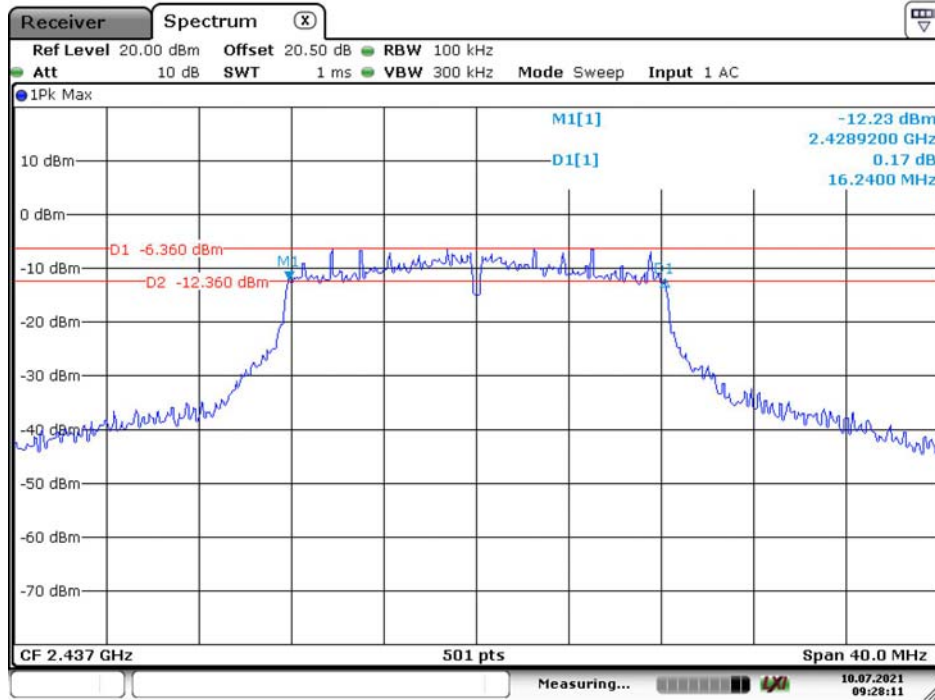

Date: 10.JUL.2021 09:28:11

802.11g High Channel

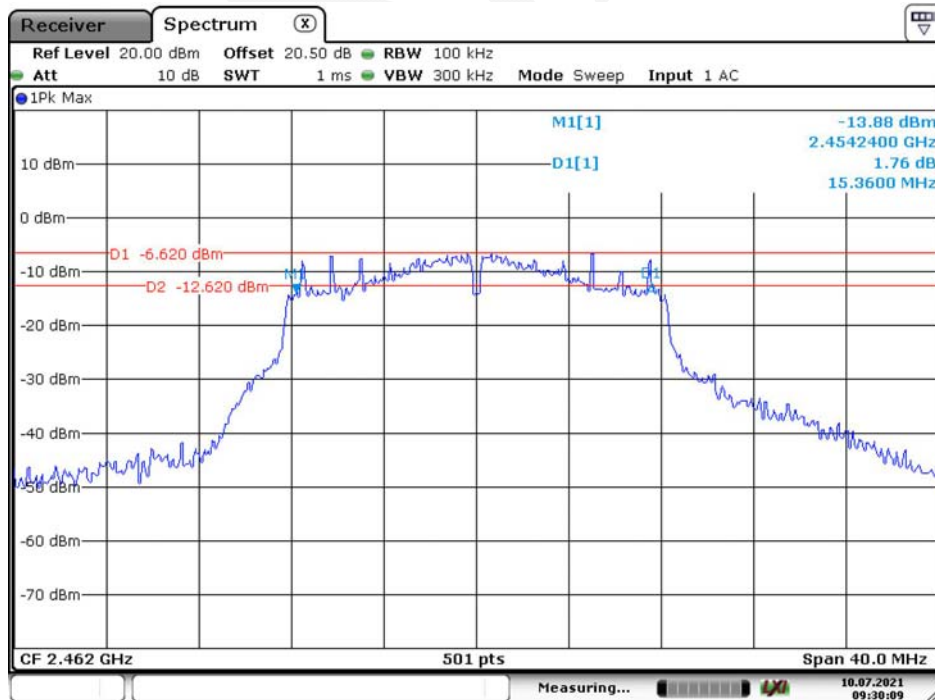

Date: 10.JUL.2021 09:30:09

802.11n ht20 Low Channel

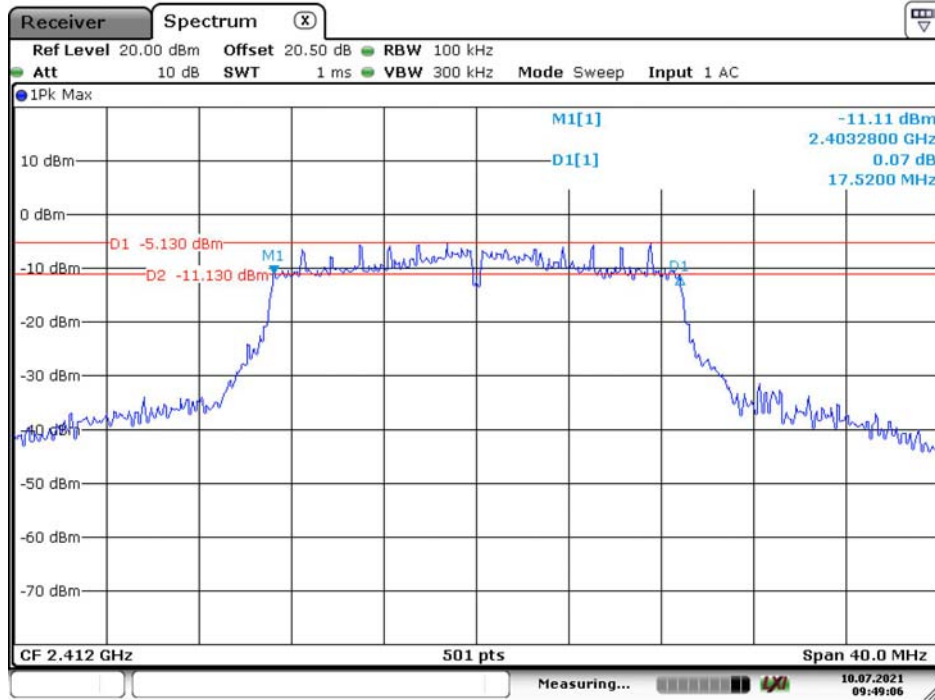

Date: 10.JUL.2021 09:49:07

802.11n ht20 Middle Channel

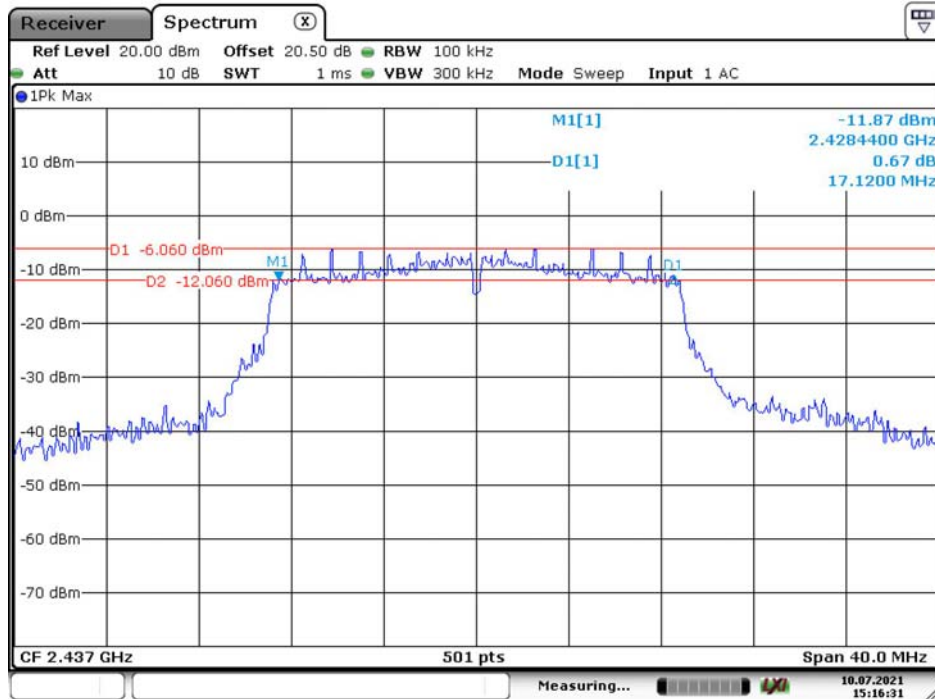

Date: 10.JUL.2021 15:16:31

802.11n ht20 High Channel

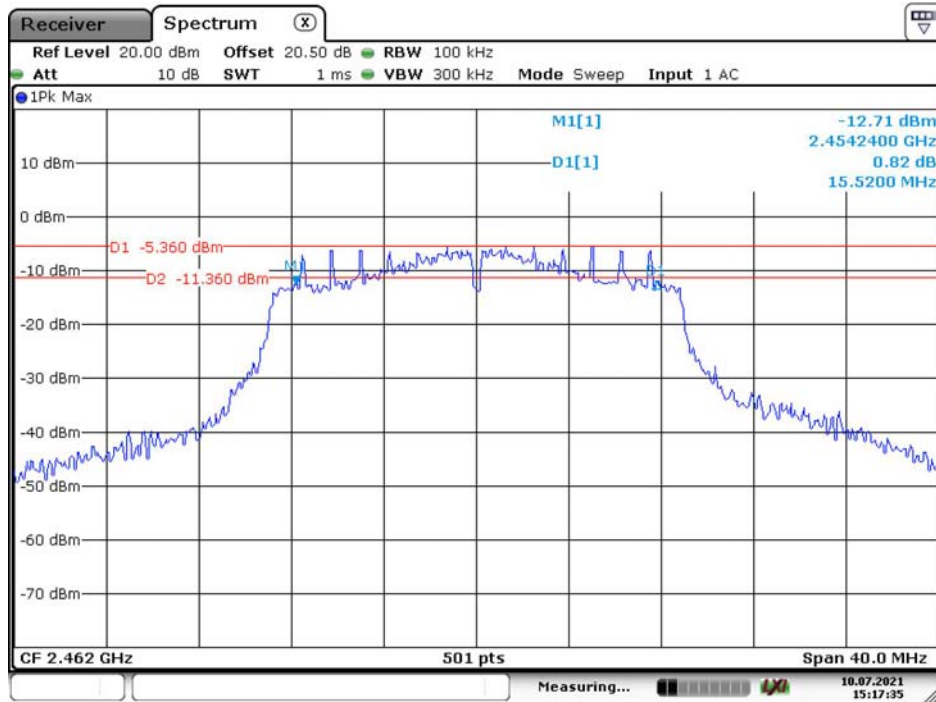

Date: 10.JUL.2021 15:17:35

802.11n ht40 Low Channel

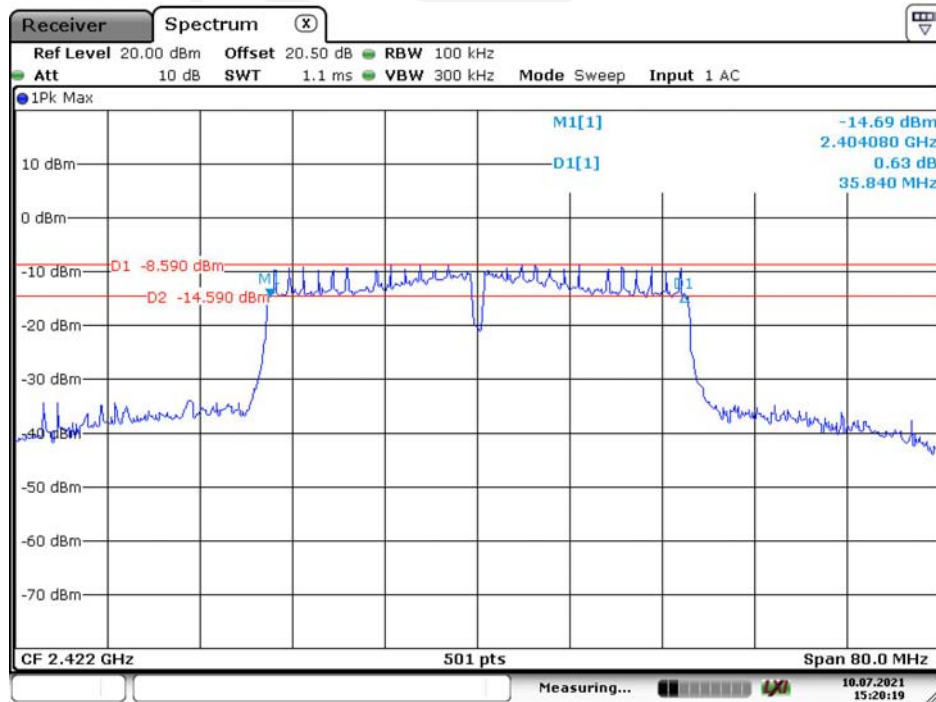

Date: 10.JUL.2021 15:20:19

802.11n ht40 Middle Channel

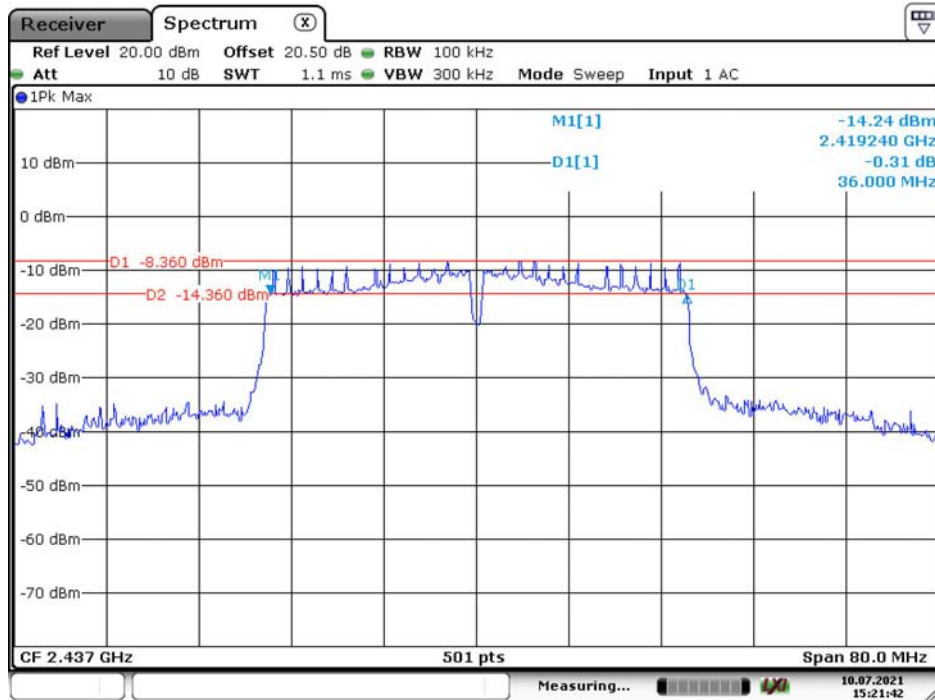

Date: 10.JUL.2021 15:21:42

802.11n ht40 High Channel

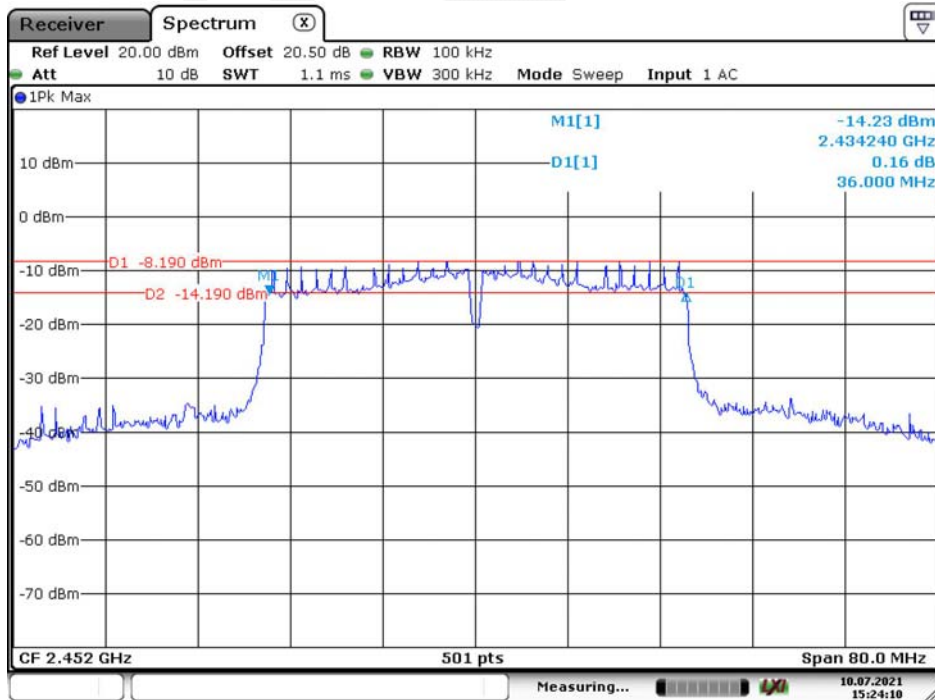

Date: 10.JUL.2021 15:24:09

BLE Low Channel

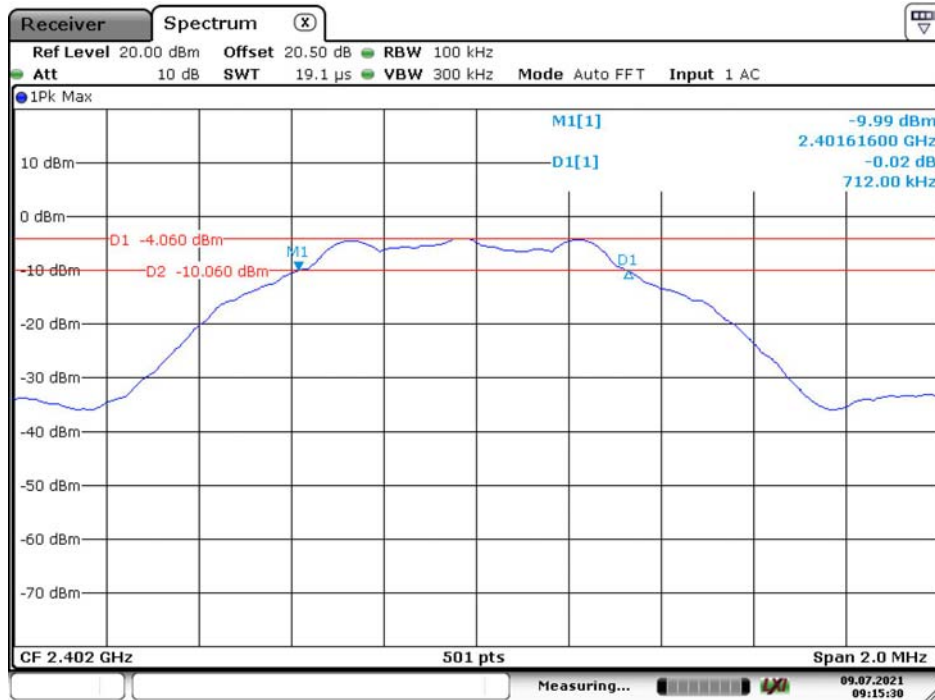

Date: 9.JUL.2021 09:15:30

BLE Middle Channel

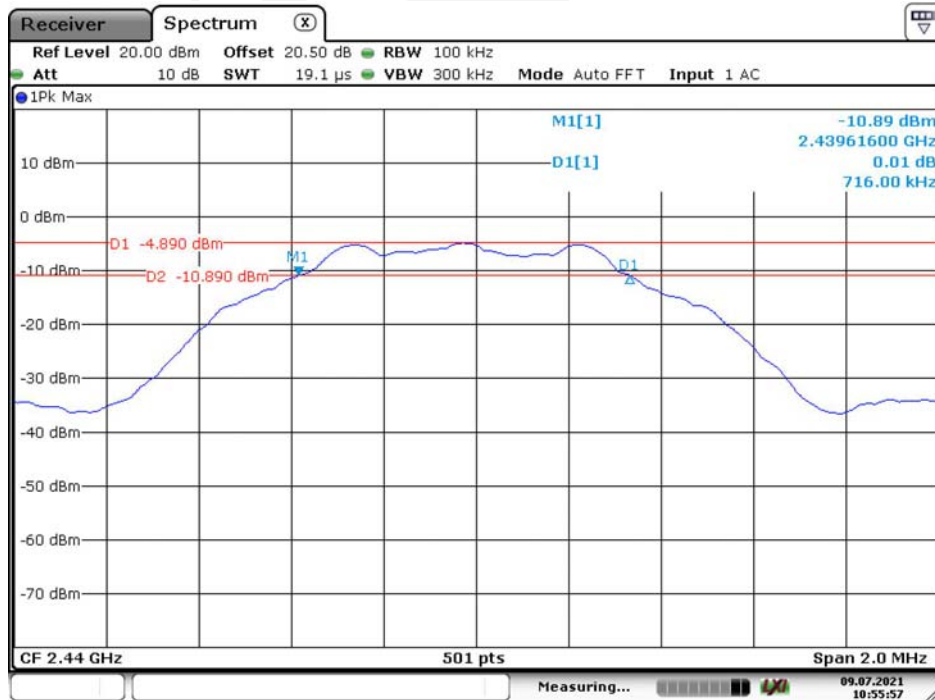

Date: 9.JUL.2021 10:55:57

BLE High Channel



Date: 9.JUL.2021 09:18:58

FEM

FCC §15.247(b) (3) - MAXIMUM PEAK CONDUCTED OUTPUT POWER

Applicable Standard

According to FCC §15.247(b) (3), for systems using digital modulation in the 902-928 MHz, 2400-2483.5 MHz, and 5725-5850 MHz bands: 1 Watt. As an alternative to a peak power measurement, compliance with the one Watt limit can be based on a measurement of the maximum conducted output power. Maximum Conducted Output Power is defined as the total transmit power delivered to all antennas and antenna elements averaged across all symbols in the signaling alphabet when the transmitter is operating at its maximum power control level. Power must be summed across all antennas and antenna elements. The average must not include any time intervals during which the transmitter is off or is transmitting at a reduced power level. If multiple modes of operation are possible (e.g., alternative modulation methods), the maximum conducted output power is the highest total transmit power occurring in any mode.

Test Procedure

1. Place the EUT on a bench and set it in transmitting mode.
2. Remove the antenna from the EUT and then connect a low loss RF cable from the antenna port to test equipment.
3. Add a correction factor to the display.
4. Set the power meter to test average output power, record the result as average power.



Test Equipment List and Details

Manufacturer	Description	Model	Serial Number	Calibration Date	Calibration Due Date
Unknown	Coaxial Cable	C-SJ00-0010	C0010/01	Each time	N/A
E-Microwave	Coaxial Attenuators	EMCA20-2RN-2	OE0120328	Each time	N/A
Agilent	USB Wideband Power Sensor	U2022XA	MY5417006	2020-09-12	2021-09-12

* **Statement of Traceability:** Bay Area Compliance Laboratories Corp. (Dongguan) attests that all calibrations have been performed, traceable to National Primary Standards and International System of Units (SI).

Test Data**Environmental Conditions**

Temperature:	27.2~27.5°C
Relative Humidity:	48~56 %
ATM Pressure:	100.5~101.1kPa
Test by:	Wayne Wei
Test Date:	2021-07-09~2021-07-10

Test Mode: Transmitting

Test Result: Compliance. Please refer to the following table.

Mode	Channel	Frequency (MHz)	Maximum Peak Conducted Output Power (dBm)	Limits (dBm)
802.11b	Low	2412	11.56	≤30
	Middle	2437	11.89	≤30
	High	2462	13.45	≤30
802.11g	Low	2412	12.46	≤30
	Middle	2437	12.48	≤30
	High	2462	12.99	≤30
802.11n ht20	Low	2412	13.21	≤30
	Middle	2437	13.45	≤30
	High	2462	13.56	≤30
802.11n ht40	Low	2422	14.3	≤30
	Middle	2437	14.22	≤30
	High	2452	14.52	≤30
BLE	Low	2402	-4.59	≤30
	Middle	2440	-5.13	≤30
	High	2480	-7.00	≤30

FCC §15.247(d)– 100 kHz BANDWIDTH OF FREQUENCY BAND EDGE

Applicable Standard

According to FCC§15.247(d):In any 100 kHz bandwidth outside the frequency band in which the spread spectrum or digitally modulated intentional radiator is operating, the radio frequency power that is produced by the intentional radiator shall be at least 20 dB below that in the 100 kHz bandwidth within the band that contains the highest level of the desired power, based on either an RF conducted or a radiated measurement, provided the transmitter demonstrates compliance with the peak conducted power limits. If the transmitter complies with the conducted power limits based on the use of RMS averaging over a time interval, as permitted under paragraph (b)(3) of this section, the attenuation required under this paragraph shall be 30 dB instead of 20 dB. Attenuation below the general limits specified in §15.209(a) is not required. In addition, radiated emissions which fall in the restricted bands, as defined in §15.205(a), must also comply with the radiated emission limits specified in §15.209(a) (see §15.205(c)).

Test Procedure

1. Check the calibration of the measuring instrument using either an internal calibrator or a known signal from an external generator.
2. Position the EUT without connection to measurement instrument. Turn on the EUT and connect its antenna terminal to measurement instrument via a low loss cable. Then set it to any one measured frequency within its operating range, and make sure the instrument is operated in its linear range.
3. Set RBW to 100 kHz and VBW of spectrum analyzer to 300 kHz with a convenient frequency span including 100 kHz bandwidth from band edge.
4. Measure the highest amplitude appearing on spectral display and set it as a reference level. Plot the graph with marking the highest point and edge frequency.
5. Repeat above procedures until all measured frequencies were complete.

Test Equipment List and Details

Manufacturer	Description	Model	Serial Number	Calibration Date	Calibration Due Date
R&S	EMI Test Receiver	ESR3	102724	2021-06-21	2022-06-20
E-Microwave	Coaxial Attenuators	EMCA20-2RN-2	OE0120328	Each time	N/A
Unknown	Coaxial Cable	C-SJ00-0010	C0010/01	Each time	N/A

** Statement of Traceability: Bay Area Compliance Laboratories Corp. (Dongguan) attests that all calibrations have been performed, traceable to National Primary Standards and International System of Units (SI).*

Test Data

Environmental Conditions

Temperature:	27.2~27.5°C
Relative Humidity:	48~56 %
ATM Pressure:	100.5~101.1kPa
Test by:	Wayne Wei
Test Date:	2021-07-09~2021-07-10

Test mode: Transmitting

Test Result: Compliance. Please refer to following plots.

802.11b: Band Edge, Left Side



Date: 10.JUL.2021 09:23:31

802.11b: Band Edge, Right Side

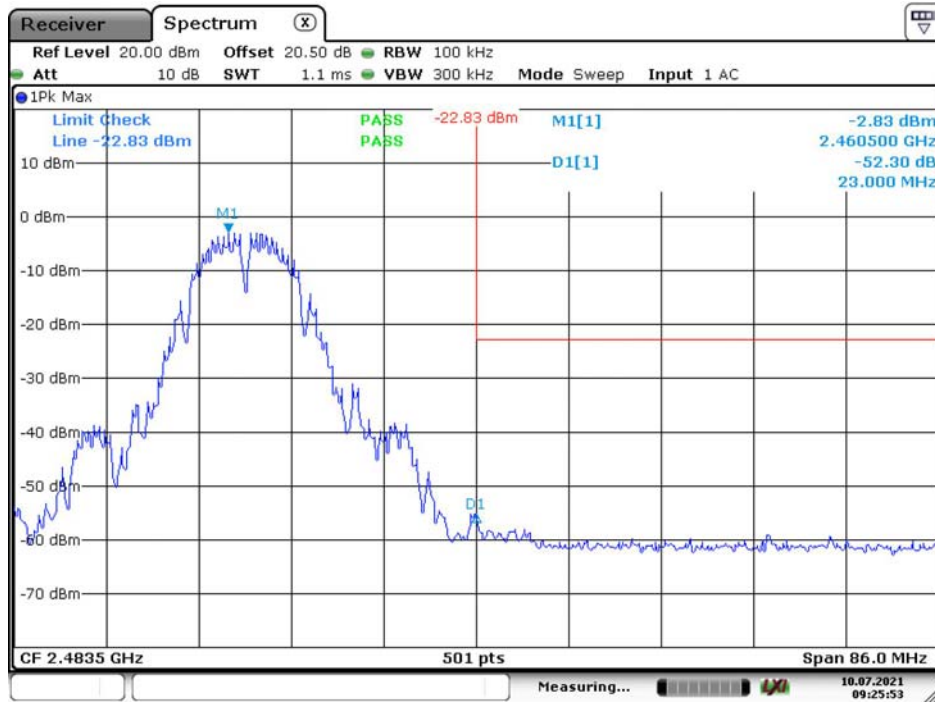

802.11g: Band Edge, Left Side

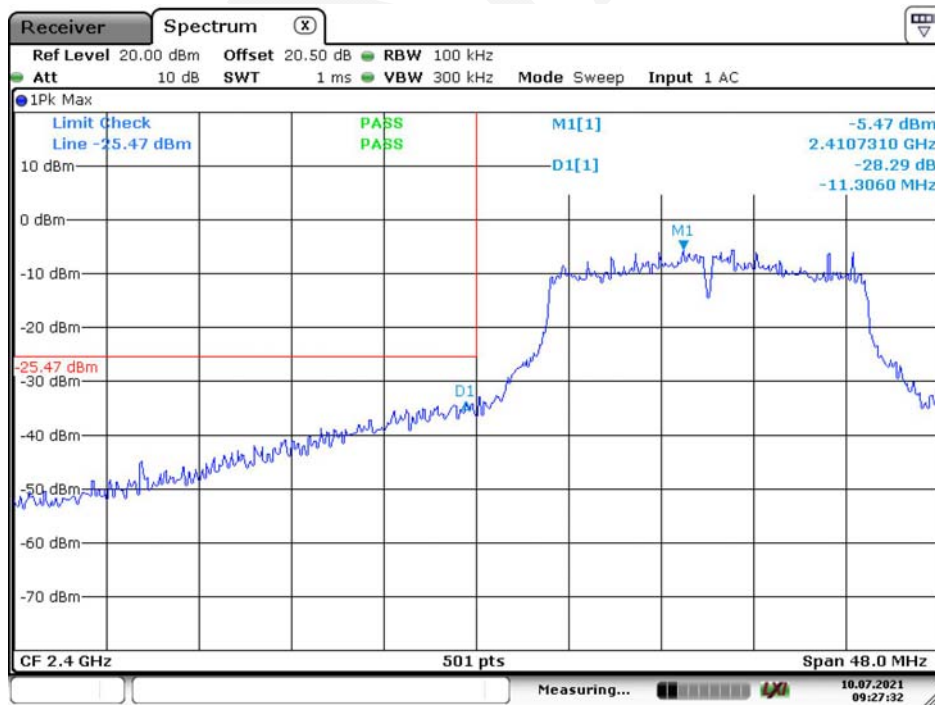

802.11g: Band Edge, Right Side

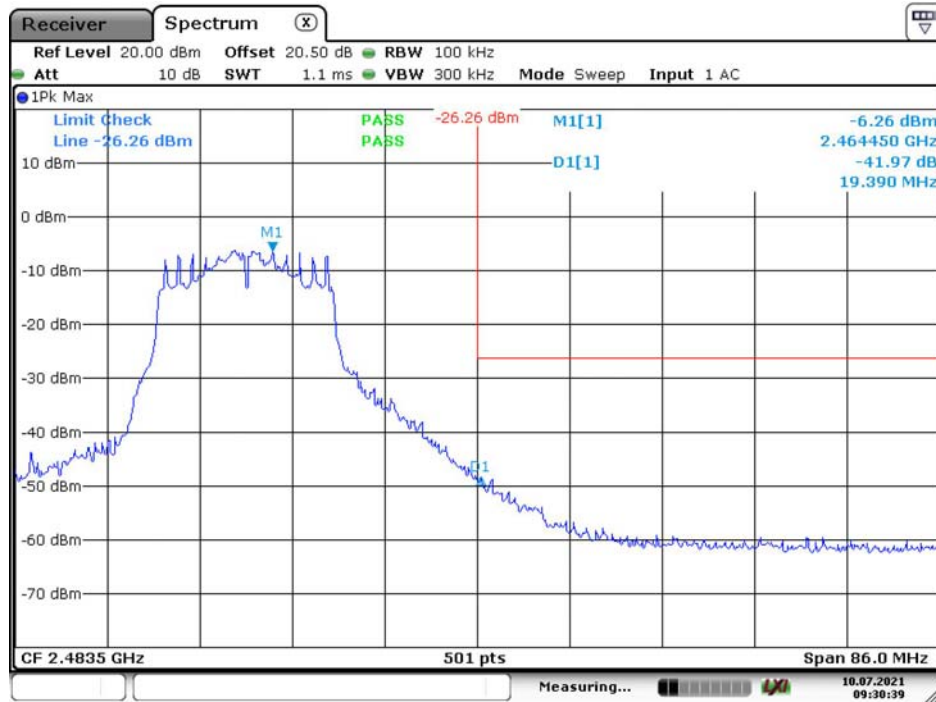

802.11n ht20 Band Edge, Left Side

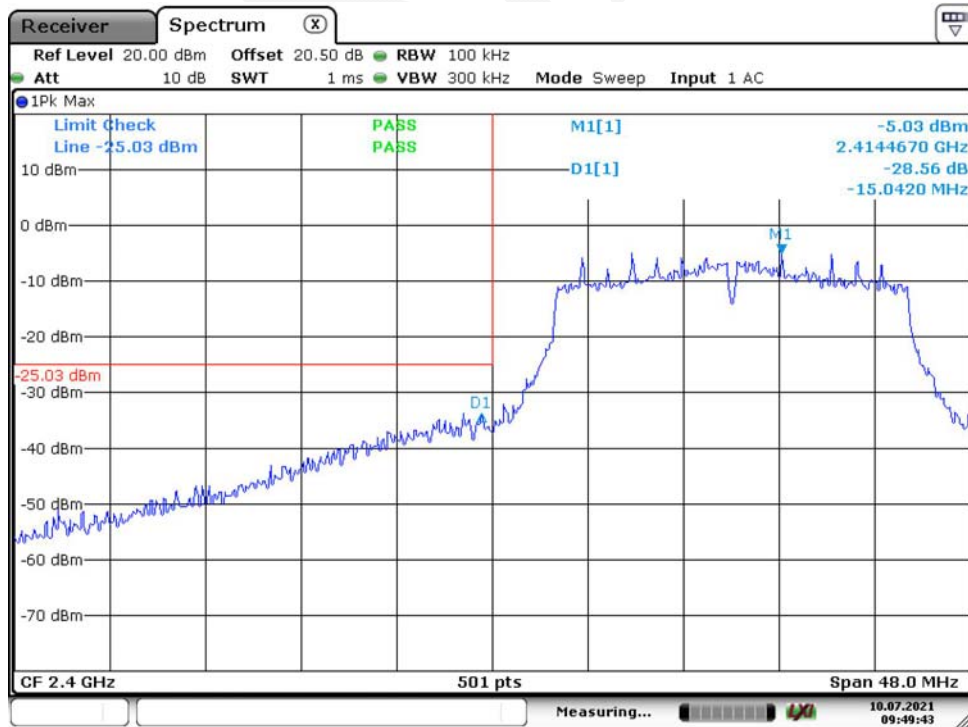

802.11n ht20 Band Edge, Right Side

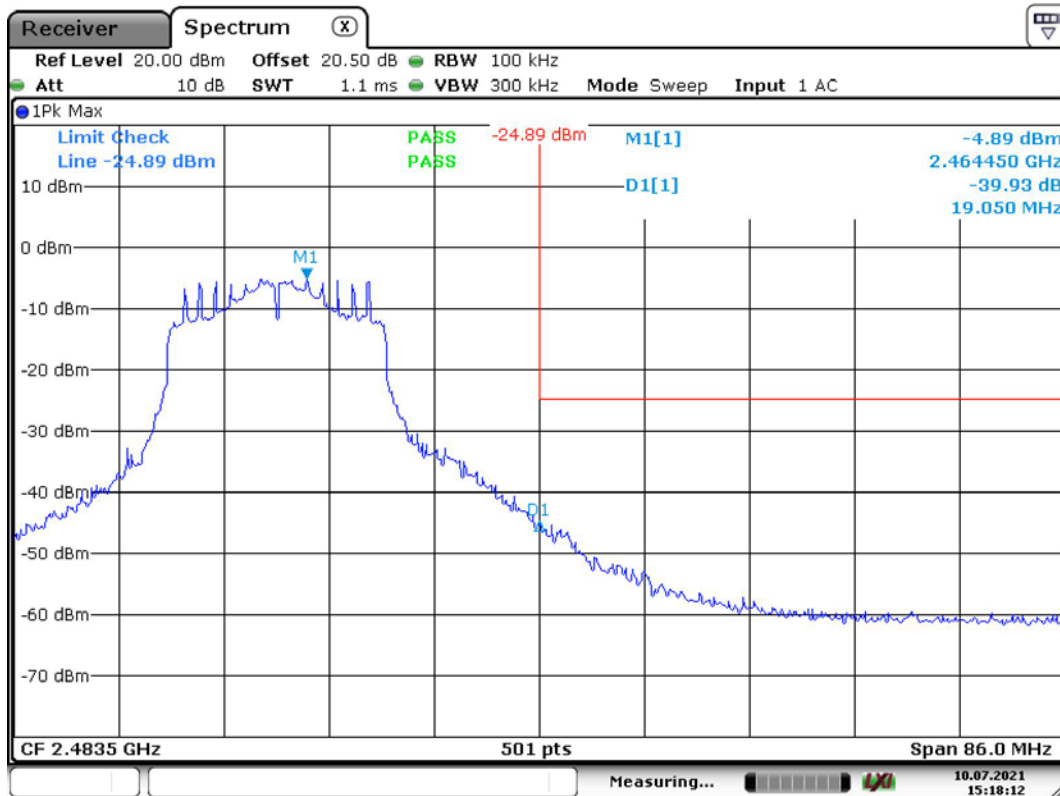

Date: 10.JUL.2021 15:18:12

802.11n ht40 Band Edge, Left Side

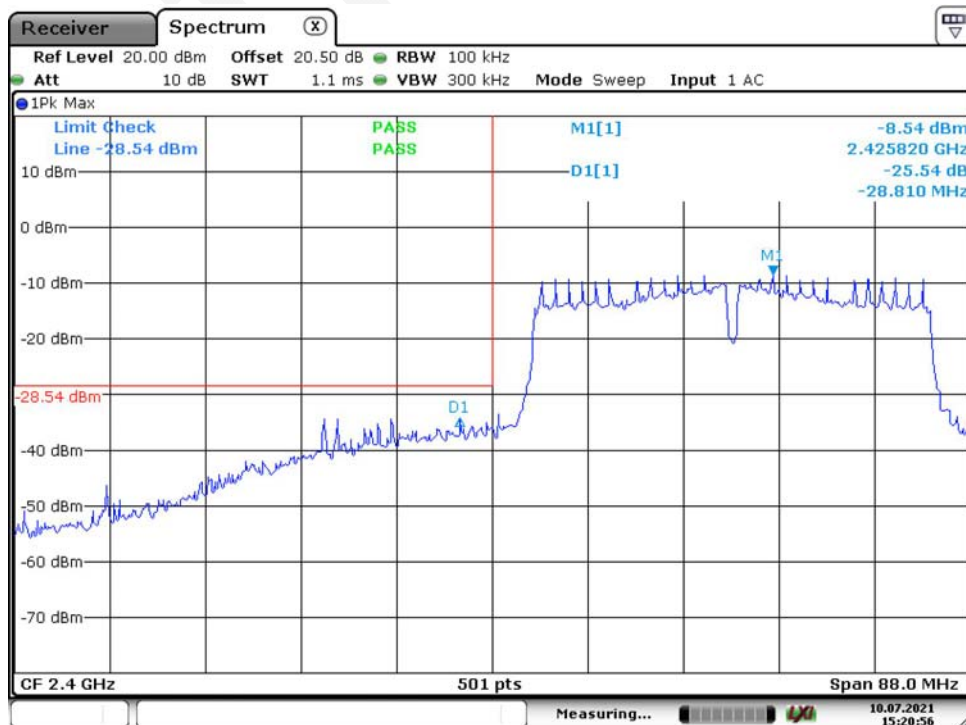

Date: 10.JUL.2021 15:20:55

802.11n ht40 Band Edge, Right Side

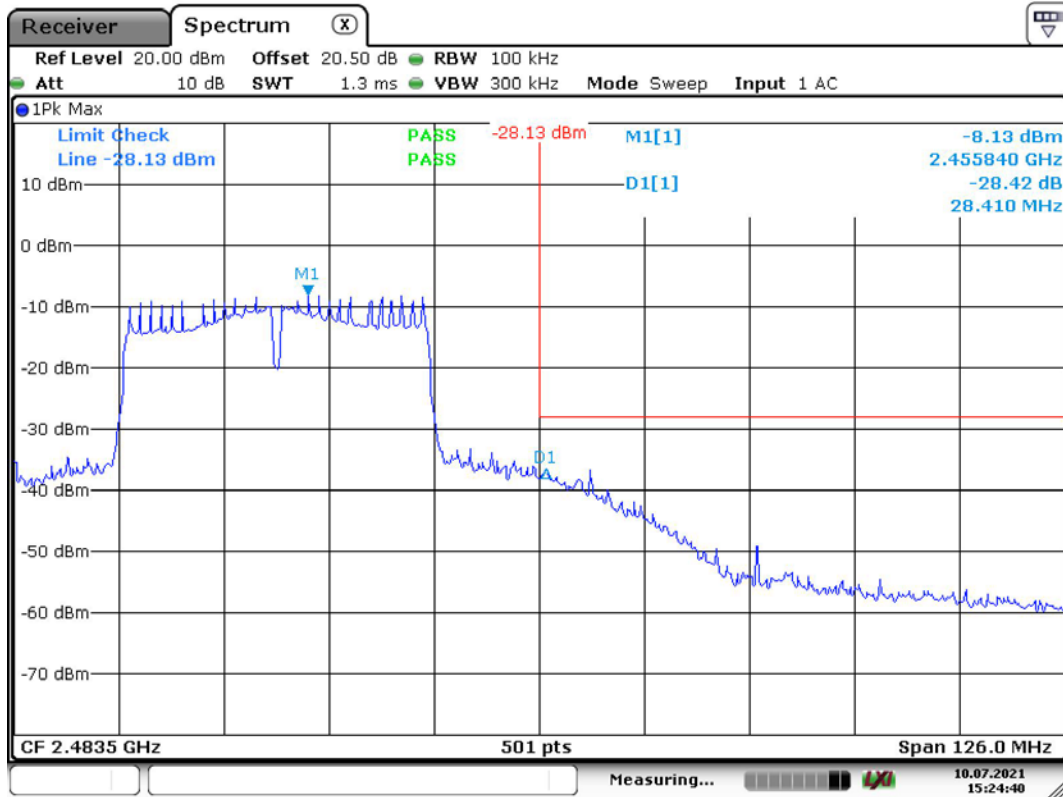

Date: 10.JUL.2021 15:24:40

BLE Band Edge, Left Side

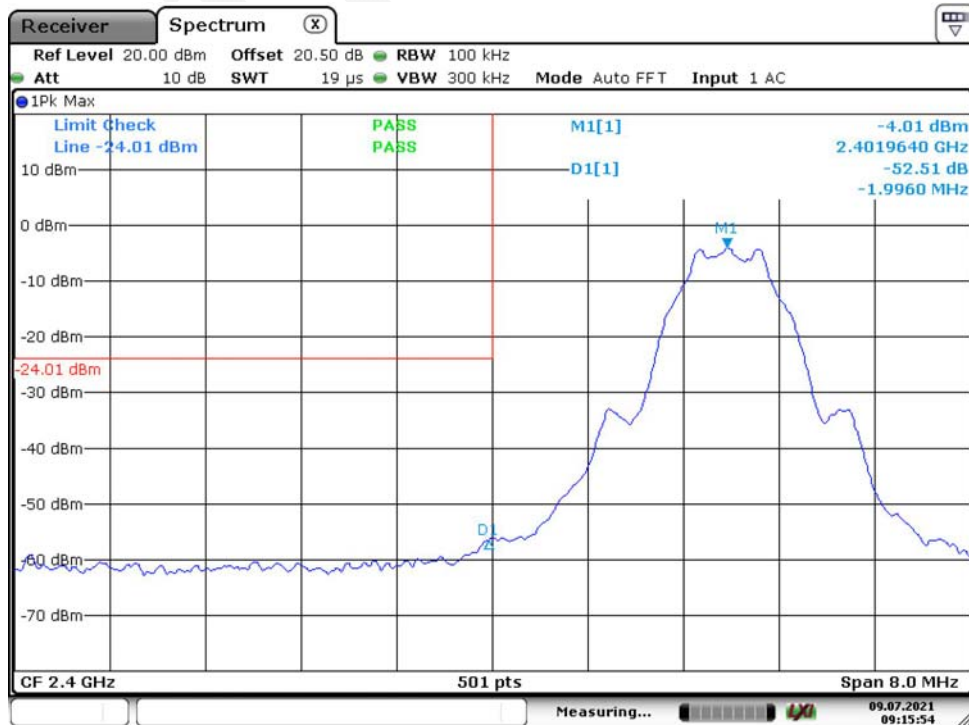

Date: 9.JUL.2021 09:15:54

BLE Band Edge, Right Side

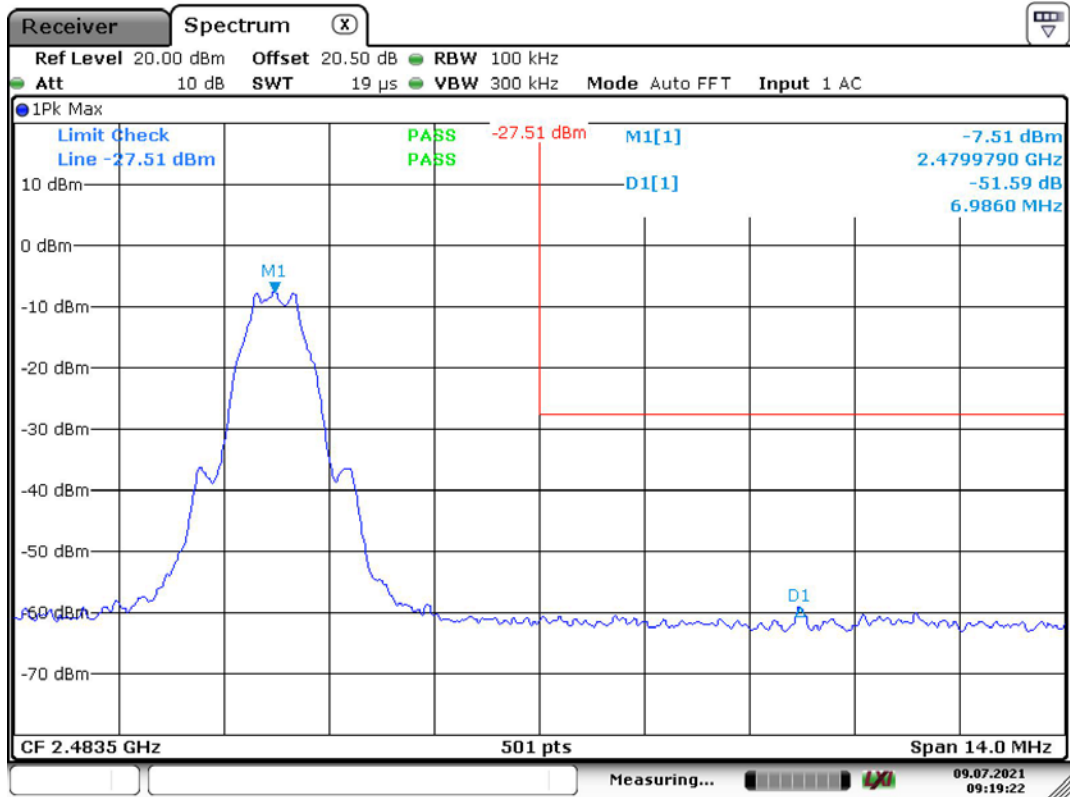

Date: 9.JUL.2021 09:19:22

FCC §15.247(e) - POWER SPECTRAL DENSITY

Applicable Standard

For digitally modulated systems, the power spectral density conducted from the intentional radiator to the antenna shall not be greater than 8 dBm in any 3 kHz band during any time interval of continuous transmission. This power spectral density shall be determined in accordance with the provisions of paragraph (b) of this section. The same method of determining the conducted output power shall be used to determine the power spectral density.

Test Procedure

1. Check the calibration of the measuring instrument using either an internal calibrator or a known signal from an external generator.
2. Position the EUT was set without connection to measurement instrument. Turn on the EUT and connect its antenna terminal to measurement instrument via a low loss cable. Then set it to any one measured frequency within its operating range, and make sure the instrument is operated in its linear range.
3. Set the RBW = 3 kHz, VBW = 10 kHz, Set the span to 1.5 times the DTS bandwidth.
4. Use the peak marker function to determine the maximum amplitude level.

Test Equipment List and Details

Manufacturer	Description	Model	Serial Number	Calibration Date	Calibration Due Date
R&S	EMI Test Receiver	ESR3	102724	2021-06-21	2022-06-20
E-Microwave	Coaxial Attenuators	EMCA20-2RN-2	OE0120328	Each time	N/A
Unknown	Coaxial Cable	C-SJ00-0010	C0010/01	Each time	N/A

* **Statement of Traceability:** Bay Area Compliance Laboratories Corp. (Dongguan) attests that all calibrations have been performed, traceable to National Primary Standards and International System of Units (SI).

Test Data

Environmental Conditions

Temperature:	27.2~27.5 °C
Relative Humidity:	48~56 %
ATM Pressure:	100.5~101.1kPa
Test by:	Wayne Wei
Test Date:	2021-07-09~2021-07-10

Test Result: Compliance. Please refer to the following table and plots

Test Mode: Transmitting

Mode	Channel	Frequency (MHz)	Power Spectral Density (dBm/3kHz)	Limits (dBm/3kHz)
802.11b	Low	2412	-13.62	≤8.0
	Middle	2437	-14.89	≤8.0
	High	2462	-17.10	≤8.0
802.11g	Low	2412	-16.90	≤8.0
	Middle	2437	-17.90	≤8.0
	High	2462	-17.22	≤8.0
802.11n ht20	Low	2412	-16.86	≤8.0
	Middle	2437	-17.52	≤8.0
	High	2462	-16.87	≤8.0
802.11n ht40	Low	2422	-21.70	≤8.0
	Middle	2437	-21.07	≤8.0
	High	2452	-21.04	≤8.0
BLE	Low	2402	-17.71	≤8.0
	Middle	2440	-18.50	≤8.0
	High	2480	-21.04	≤8.0

Power Spectral Density, 802.11b Low Channel

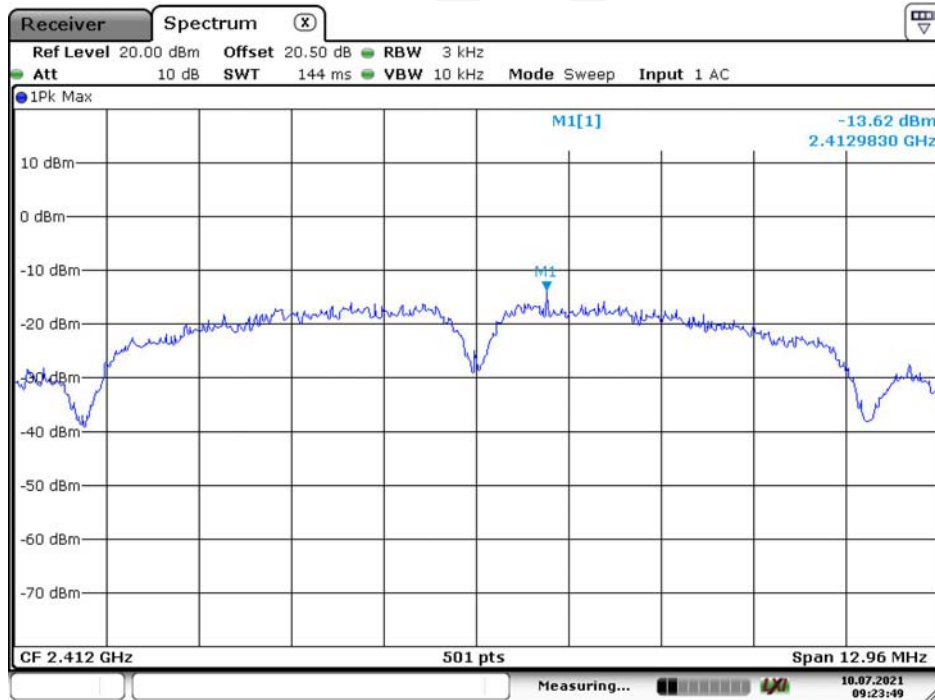

Date: 10.JUL.2021 09:23:49

Power Spectral Density, 802.11b Middle Channel

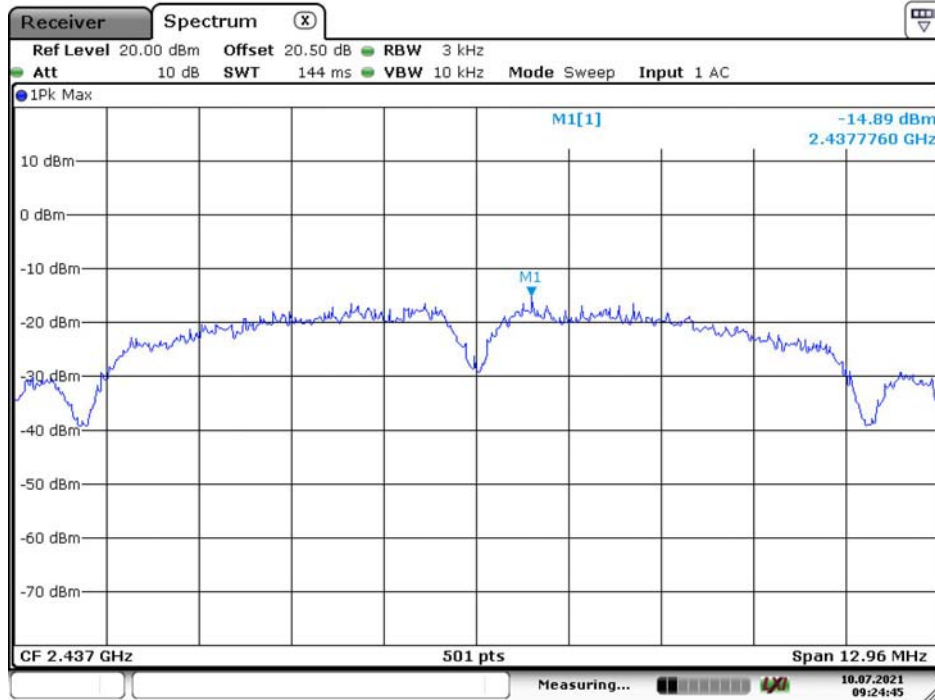

Date: 10.JUL.2021 09:24:45

Power Spectral Density, 802.11b High Channel

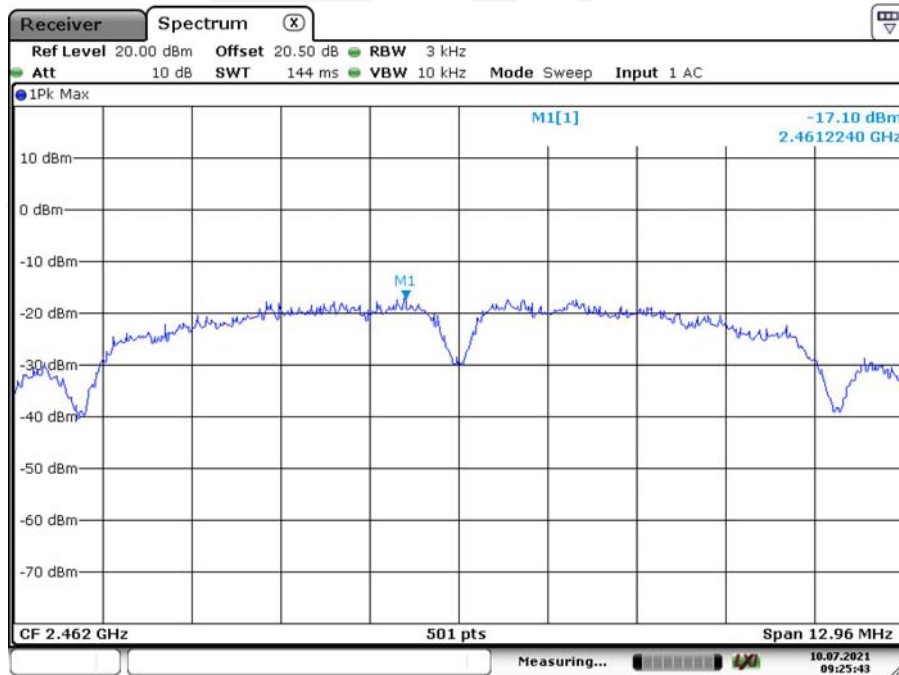

Date: 10.JUL.2021 09:25:43

Power Spectral Density, 802.11g Low Channel

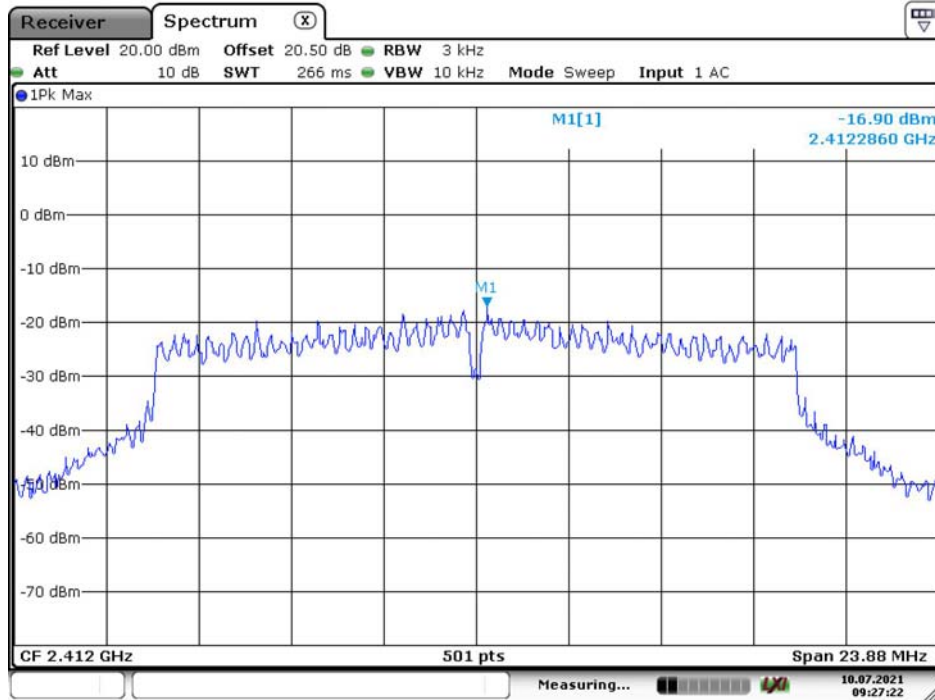

Date: 10.JUL.2021 09:27:22

Power Spectral Density, 802.11g Middle Channel

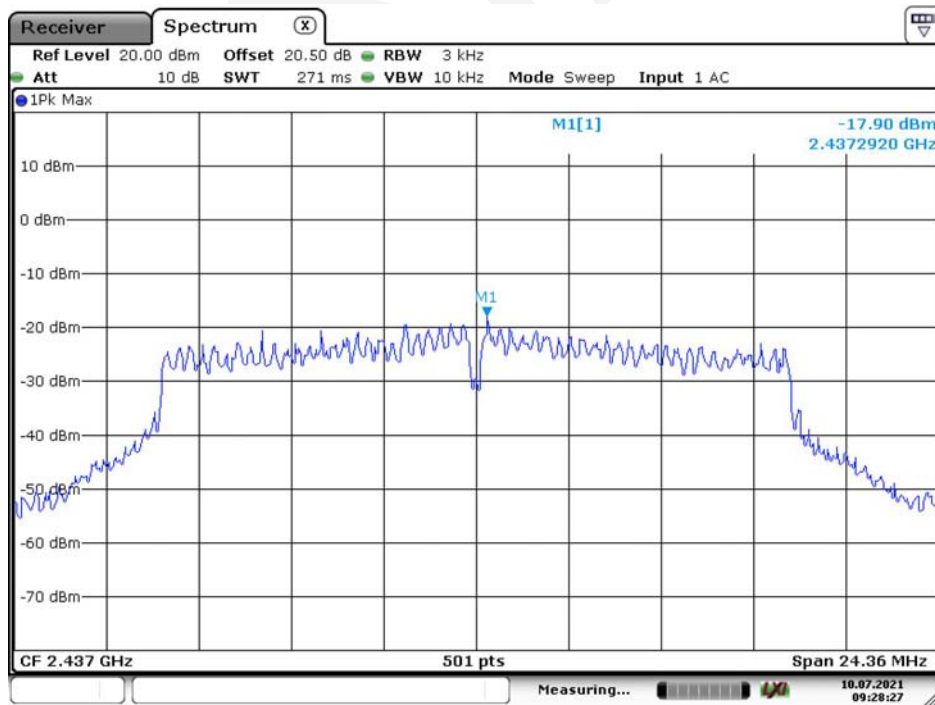

Date: 10.JUL.2021 09:28:28

Power Spectral Density, 802.11g High Channel

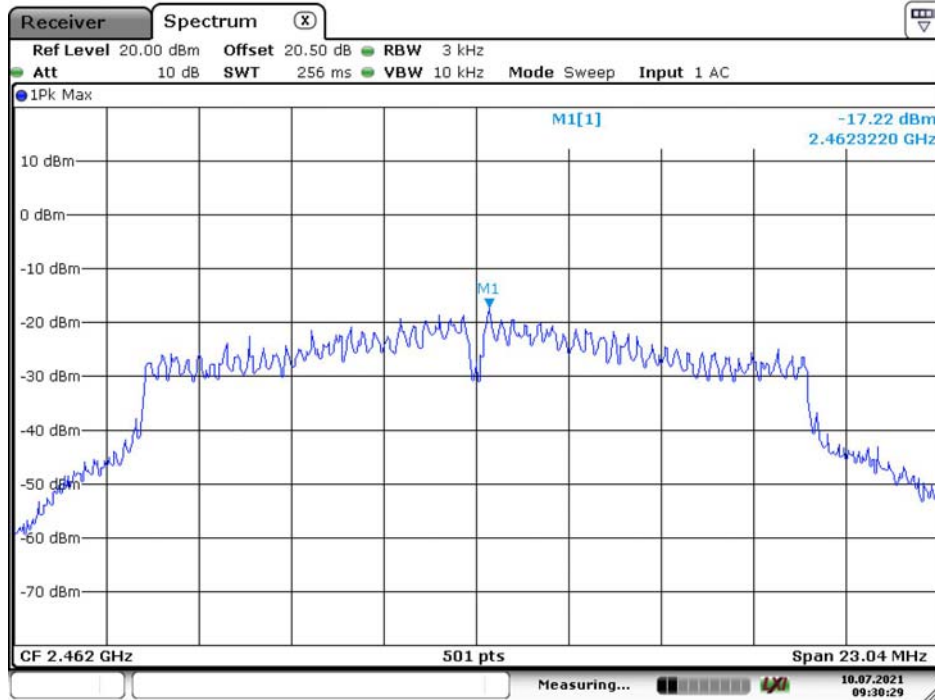

Date: 10.JUL.2021 09:30:29

Power Spectral Density, 802.11n ht20 Low Channel

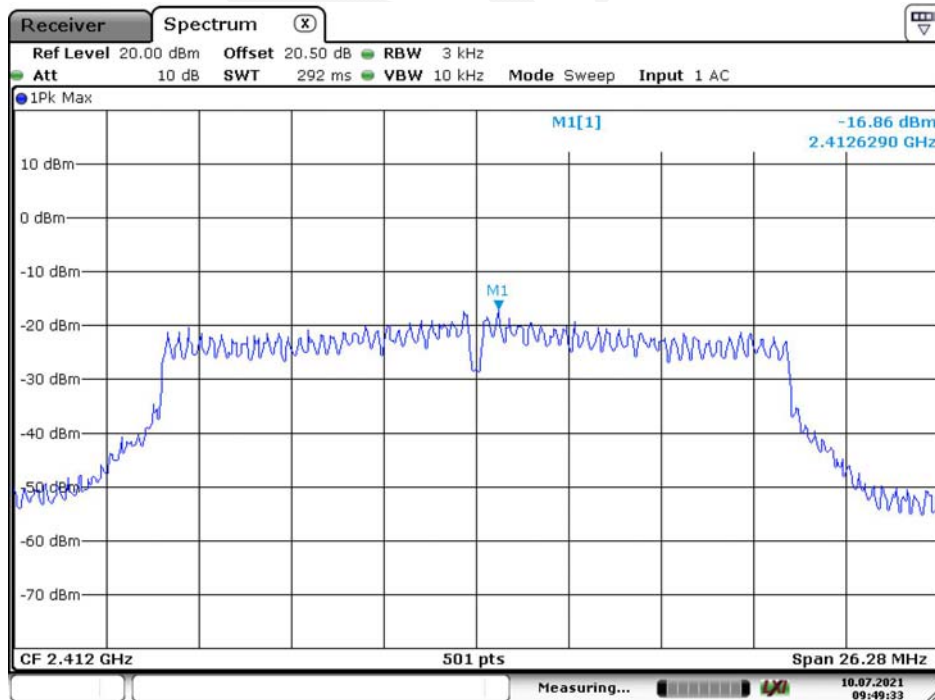

Date: 10.JUL.2021 09:49:33

Power Spectral Density, 802.11n ht20 Middle Channel

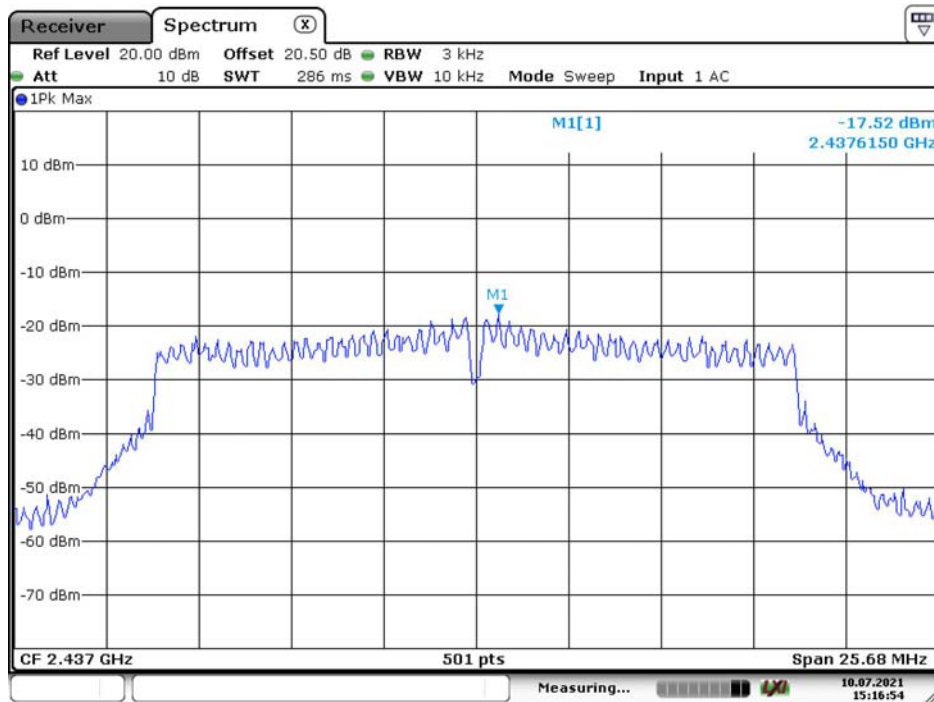

Date: 10.JUL.2021 15:16:54

Power Spectral Density, 802.11n ht20 High Channel

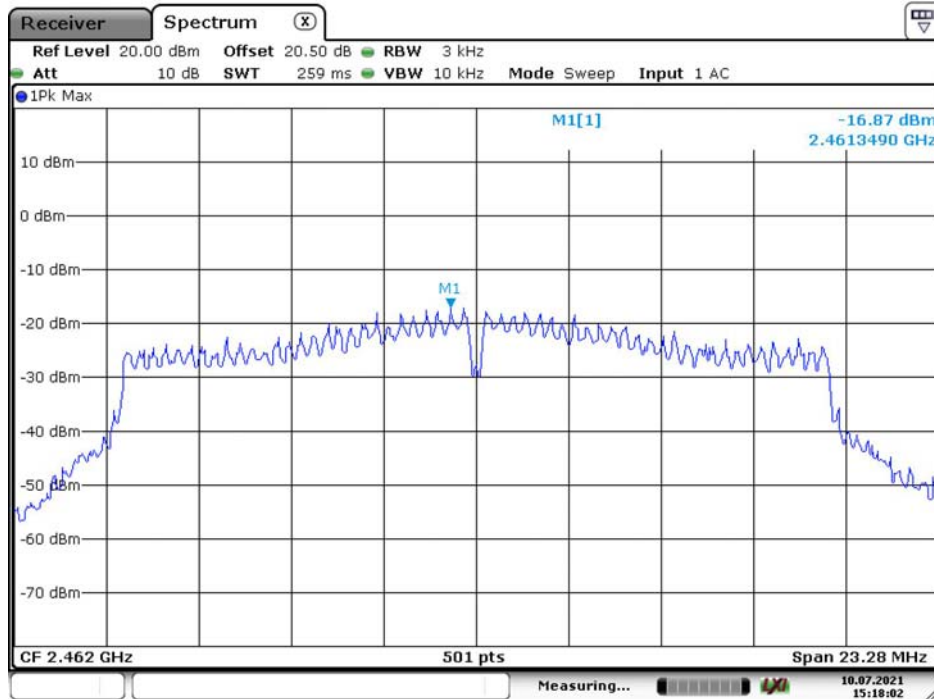

Date: 10.JUL.2021 15:18:02

Power Spectral Density, 802.11n ht40 Low Channel

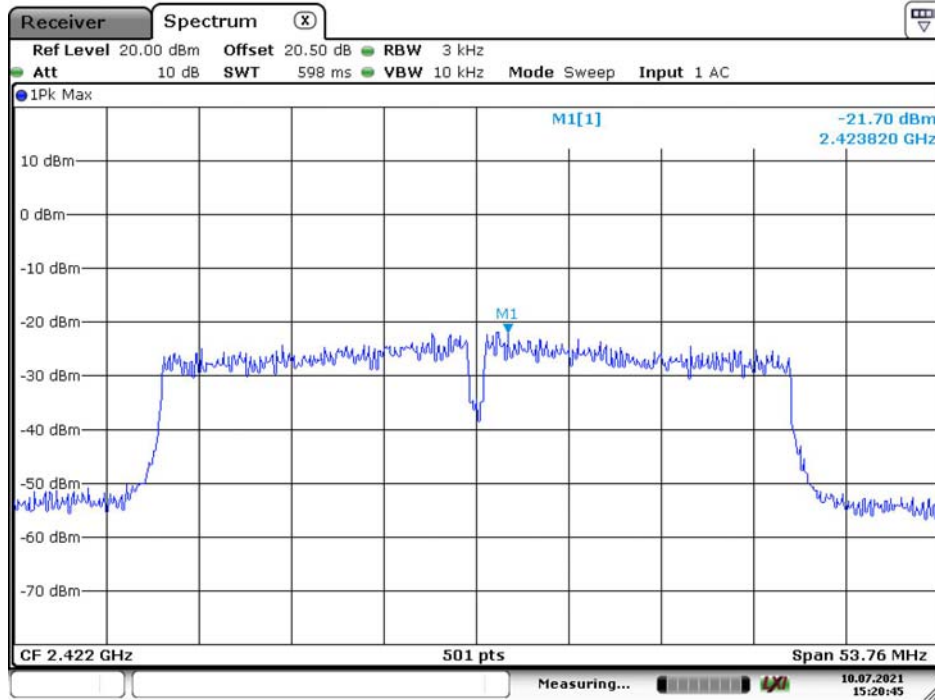

Date: 10.JUL.2021 15:20:45

Power Spectral Density, 802.11n ht40 Middle Channel

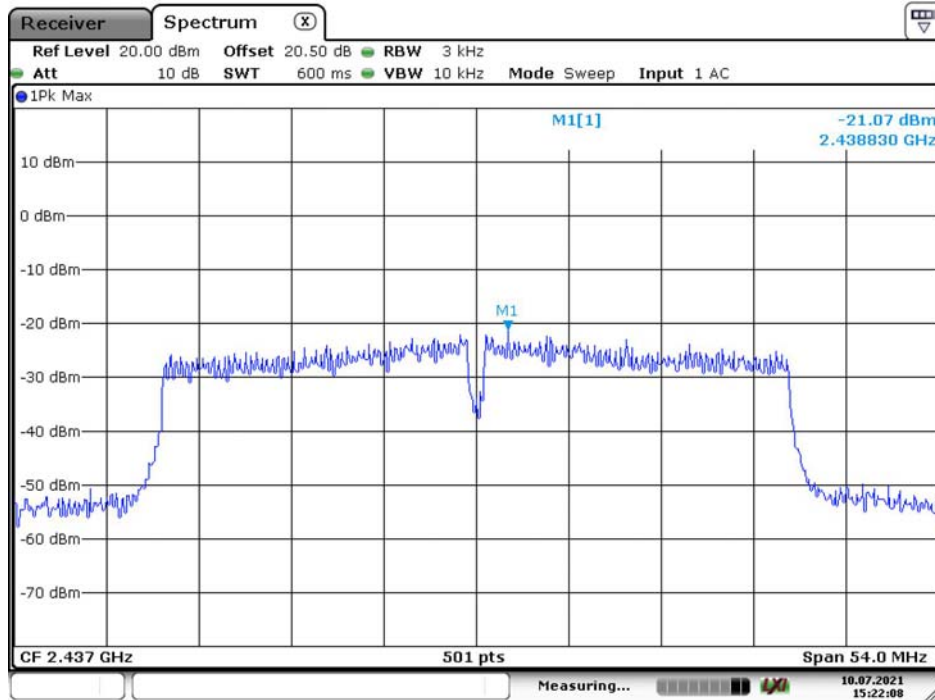

Date: 10.JUL.2021 15:22:08

Power Spectral Density, 802.11n ht40 High Channel

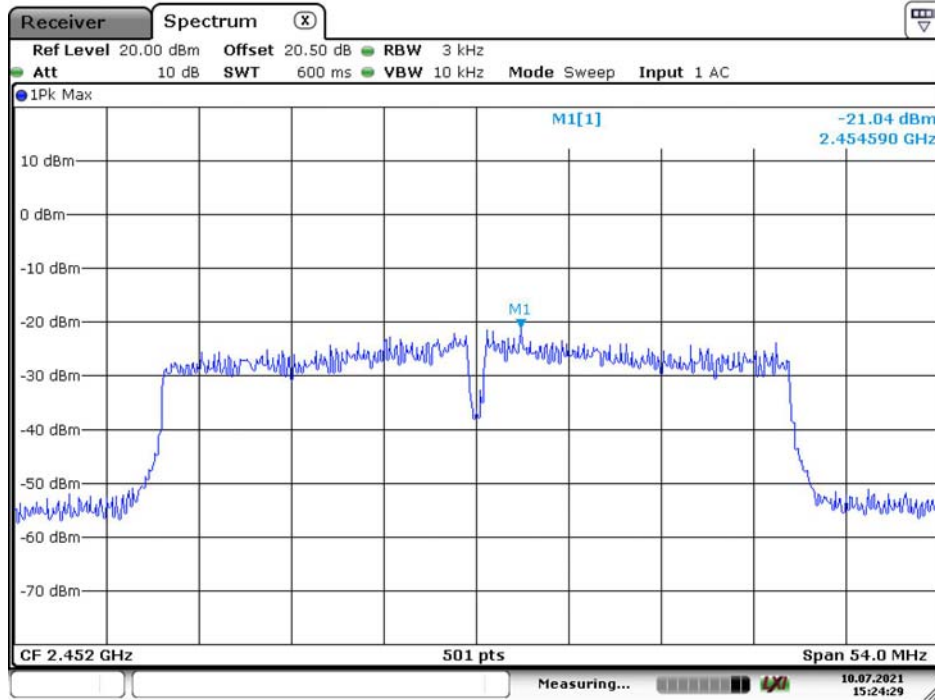

Date: 10.JUL.2021 15:24:29

Power Spectral Density, BLE Low Channel

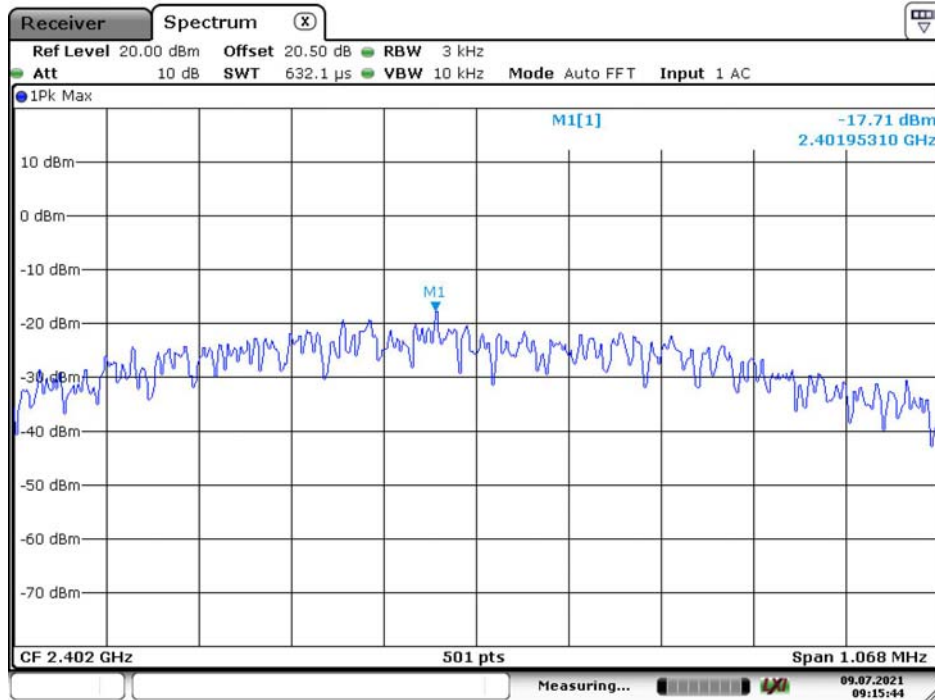

Date: 9.JUL.2021 09:15:44

Power Spectral Density, BLE Middle Channel

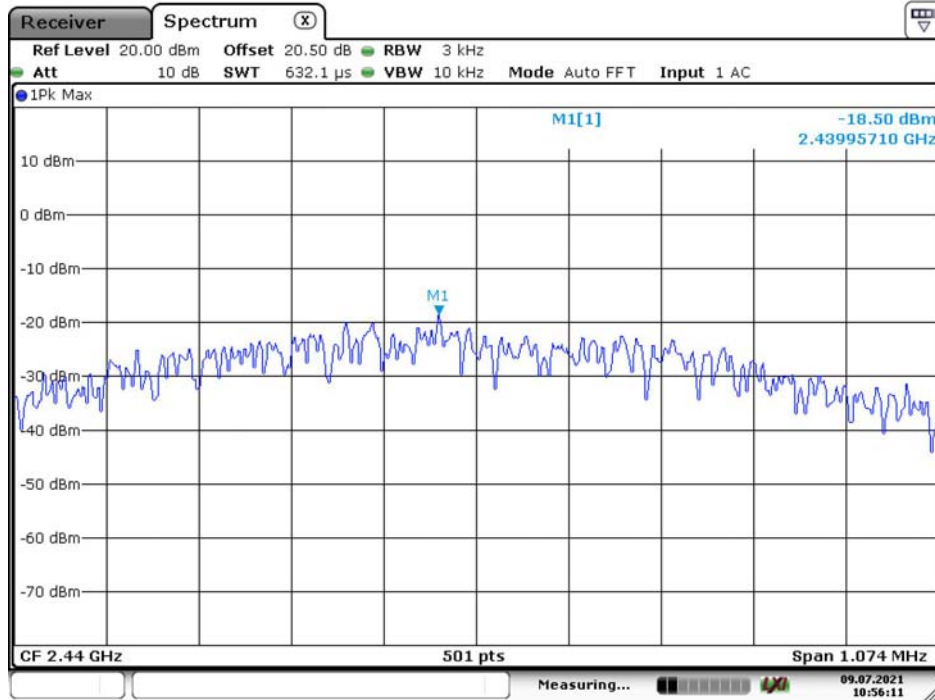

Date: 9.JUL.2021 10:56:11

Power Spectral Density, BLE High Channel

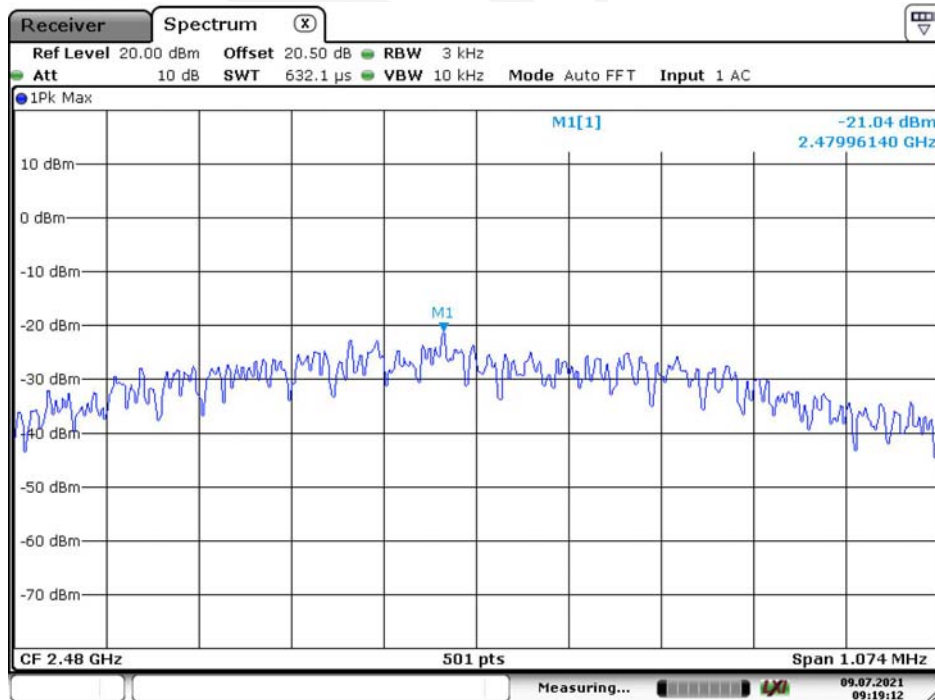

Date: 9.JUL.2021 09:19:11

***** END OF REPORT *****