



中认信通

CHINA CERTIFICATION ICT CO., LTD (DONGGUAN)



TEST REPORT

Applicant: Beijing COTX Networks Technologies Co., Ltd.

Address: B218, Block F, Wangjing, Wanke Times Center, Chaoyang District,
Beijing, China

FCC ID: 2A2A2X1

Product Name: cotx x1 hotspot

Model Number: X1, X1-EU, X1-E, X1-E1, X1-E2, X1-E3

**Standard(s): 47 CFR Part 15, Subpart C(15.247)
ANSI C63.10-2013
KDB 558074 D01 15.247 Meas Guidance v05r02**

The above equipment has been tested and found compliant with the requirement of the relative standards by China Certification ICT Co., Ltd (Dongguan)

Report Number: CR22040013-00A

Date Of Issue: 2022-05-09

Reviewed By: Sun Zhong

Sun Zhong

Title: Manager

Test Laboratory: China Certification ICT Co., Ltd (Dongguan)

No. 113, Pingkang Road, Dalang Town, Dongguan,
Guangdong, China
Tel: +86-769-82016888

Test Facility

The Test site used by China Certification ICT Co., Ltd (Dongguan) to collect test data is located on the No. 113, Pingkang Road, Dalang Town, Dongguan, Guangdong, China.

The lab has been recognized as the FCC accredited lab under the KDB 974614 D01 and is listed in the FCC Public Access Link (PAL) database, FCC Registration No. : 442868, the FCC Designation No. : CN1314.

The lab has been recognized by Innovation, Science and Economic Development Canada to test to Canadian radio equipment requirements, the CAB identifier: CN0123.

Declarations

China Certification ICT Co., Ltd (Dongguan) is not responsible for the authenticity of any test data provided by the applicant. Data included from the applicant that may affect test results are marked with a triangle symbol “▲”. Customer model name, addresses, names, trademarks etc. are not considered data.

Unless otherwise stated the results shown in this test report refer only to the sample(s) tested.

This report cannot be reproduced except in full, without prior written approval of the Company.

This report is valid only with a valid digital signature. The digital signature may be available only under the Adobe software above version 7.0.

This report may contain data that are not covered by the accreditation scope and shall be marked with an asterisk “★”.

CONTENTS

TEST FACILITY	2
DECLARATIONS.....	2
1. GENERAL INFORMATION	5
1.1 PRODUCT DESCRIPTION FOR EQUIPMENT UNDER TEST (EUT)	5
1.2 DESCRIPTION OF TEST CONFIGURATION.....	8
1.2.1 EUT Operation Condition:	8
1.2.2 Support Equipment List and Details	8
1.2.3 Support Cable List and Details	8
1.2.4 Block Diagram of Test Setup.....	9
1.3 MEASUREMENT UNCERTAINTY	10
2. SUMMARY OF TEST RESULTS	11
3. REQUIREMENTS AND TEST PROCEDURES	12
3.1 AC LINE CONDUCTED EMISSIONS.....	12
3.1.1 Applicable Standard.....	12
3.1.2 EUT Setup.....	13
3.1.3 EMI Test Receiver Setup	13
3.1.4 Test Procedure	14
3.1.5 Corrected Amplitude & Margin Calculation.....	14
3.2 RADIATION SPURIOUS EMISSIONS	15
3.2.1 Applicable Standard.....	15
3.2.2 EUT Setup.....	15
3.2.3 EMI Test Receiver & Spectrum Analyzer Setup	16
3.2.4 Test Procedure	16
3.2.5 Corrected Amplitude & Margin Calculation.....	16
3.3 6 DB EMISSION BANDWIDTH:.....	17
3.3.1 Applicable Standard.....	17
3.3.2 EUT Setup.....	17
3.3.3 Test Procedure	17
3.4 MAXIMUM PEAK CONDUCTED OUTPUT POWER:.....	18
3.4.1 Applicable Standard.....	18
3.4.2 EUT Setup.....	18
3.4.3 Test Procedure	18
3.5 MAXIMUM POWER SPECTRAL DENSITY:	19
3.5.1 Applicable Standard.....	19
3.5.2 EUT Setup.....	19
3.5.3 Test Procedure	19
3.6 100 KHZ BANDWIDTH OF FREQUENCY BAND EDGE:	20
3.6.1 Applicable Standard.....	20
3.6.2 EUT Setup.....	20
3.6.3 Test Procedure	20
3.7 DUTY CYCLE:.....	21

3.7.1 EUT Setup.....	21
3.7.2 Test Procedure	21
3.8 ANTENNA REQUIREMENT.....	21
3.8.1 Applicable Standard.....	21
3.8.2 Judgment.....	21
4. Test DATA AND RESULTS.....	22
4.1 AC LINE CONDUCTED EMISSIONS.....	22
4.2 RADIATION SPURIOUS EMISSIONS.....	25
4.3 6 dB EMISSION BANDWIDTH:.....	35
4.4 MAXIMUM PEAK CONDUCTED OUTPUT POWER:.....	41
4.5 MAXIMUM POWER SPECTRAL DENSITY:	42
4.6 100 kHz BANDWIDTH OF FREQUENCY BAND EDGE:	49
4.7 DUTY CYCLE:.....	55
5. RF EXPOSURE EVALUATION	58
5.1 MAXIMUM PERMISSIBLE EXPOSURE (MPE)	58
5.1.1 APPLICABLE STANDARD.....	58
5.1.2 PROCEDURE.....	58

1. GENERAL INFORMATION

1.1 Product Description for Equipment under Test (EUT)

EUT Name:	cotx x1 hotspot
EUT Model:	X1
Operation Frequency:	2412-2462 MHz(802.11b/g/n ht20) , 2422-2452 MHz(802.11n ht40) 2402-2480MHz(BLE)
Maximum Peak Output Power (Conducted):	22.46 dBm(802.11b/g/n) 5.71 dBm(BLE)
Modulation Type:	DSSS, OFDM(802.11b/g/n) GFSK(BLE)
Rated Input Voltage:	DC 5V from adapter
Serial Number:	CR22040013-RF-S1
EUT Received Date:	2022.04.08
EUT Received Status:	Good

Operation Frequency Detail: For 802.11b/g/n ht20:

Channel	Frequency (MHz)	Channel	Frequency (MHz)
1	2412	7	2442
2	2417	8	2447
3	2422	9	2452
4	2427	10	2457
5	2432	11	2462
6	2437	/	/

Per section 15.31(m), the below frequencies were performed the test as below:

Test Channel	Frequency (MHz)
Lowest	2412
Middle	2437
Highest	2462

For 802.11n ht40:

Channel	Frequency (MHz)	Channel	Frequency (MHz)
3	2422	7	2442
4	2427	8	2447
5	2432	9	2452
6	2437	/	/

Per section 15.31(m), the below frequencies were performed the test as below:

Test Channel	Frequency (MHz)
Lowest	2422
Middle	2437
Highest	2452

For BLE:

Channel	Frequency (MHz)	Channel	Frequency (MHz)
0	2402	20	2442
1	2404
...
...
..	...	38	2478
19	2440	39	2480

Per section 15.31(m), the below frequencies were performed the test as below:

Test Channel	Frequency (MHz)
Lowest	2402
Middle	2440
Highest	2480

Antenna Information Detail ▲ :

For WiFi Antenna:

Antenna Usage	Manufacturer	Antenna Type	input impedance (Ohm)	Antenna Gain /Frequency Range	§15.203 Requirement
WiFi	Beijing COTX Networks Technologies Co.,Ltd.	Dipole	50	4dBi/ 2.4~2.5GHz	Compliant

The Method of §15.203 Compliance:

- Antenna must be permanently attached to the unit.
 Antenna must use a unique type of connector to attach to the EUT.
 Unit must be professionally installed, and installer shall be responsible for verifying that the correct antenna is employed with the unit.

For BLE Antenna:

Antenna Usage	Manufacturer	Antenna Type	input impedance (Ohm)	Antenna Gain /Frequency Range	§15.203 Requirement
BLE	Beijing COTX Networks Technologies Co.,Ltd.	PCB	50	2dBi/ 2.4~2.5GHz	Compliant

The Method of §15.203 Compliance:

- Antenna must be permanently attached to the unit.
 Antenna must use a unique type of connector to attach to the EUT.
 Unit must be professionally installed, and installer shall be responsible for verifying that the correct antenna is employed with the unit.

Accessory Information:

Accessory Description	Manufacturer	Model	Parameters
Adapter	NINGHAI COUNTRY YSHUN ELECTRICAL CO,LED	YSM02U10- 0502000A	Input: 120Vac 60Hz Max0.25A Output: 5Vdc 2A 10W

1.2 Description of Test Configuration

1.2.1 EUT Operation Condition:

For 802.11b/g/n:

EUT Operation Mode:	The system was configured for testing in Engineering Mode, which was provided by the manufacturer.			
Equipment Modifications:	No			
EUT Exercise Software:	MT7628 QA			
The software was provided by manufacturer. The maximum power was configured as below, that was provided by the manufacturer ▲ :				
Test Modes	Data Rate	Power Level Setting		
		Lowest Channel	Middle Channel	Highest Channel
802.11b	1Mbps	18	18	17
802.11g	6Mbps	19	1A	18
802.11n ht20	MCS0	1A	1A	18
802.11n ht40	MCS0	1B	1C	1C
The above are the worst-case data rates, which are determined for each mode based upon investigations by measuring the average power and PSD across all data rates, bandwidths, and modulations.				

For BLE:

EUT Operation Mode:	The system was configured for testing in Engineering Mode, which was provided by the manufacturer.		
Equipment Modifications:	No		
EUT Exercise Software:	PhyPluskit		
The software was provided by manufacturer. The maximum power was configured as below, that was provided by the manufacturer ▲ :			
Data Rate	Power Level Setting		
	Lowest Channel	Middle Channel	Highest Channel
2Mbps	Default	Default	Default
Note: The BLE can't supports 1Mbps mode, which was disabled by software by manufacturer.			

1.2.2 Support Equipment List and Details

Manufacturer	Description	Model	Serial Number
Lenovo	Laptop	G510	CB30920865

1.2.3 Support Cable List and Details

Cable Description	Shielding Type	Ferrite Core	Length (m)	From Port	To
RJ45 Cable	No	No	10	EUT	Laptop
USB Cable	No	No	1.2	Adapter	EUT

1.2.4 Block Diagram of Test Setup

AC line conducted emissions:

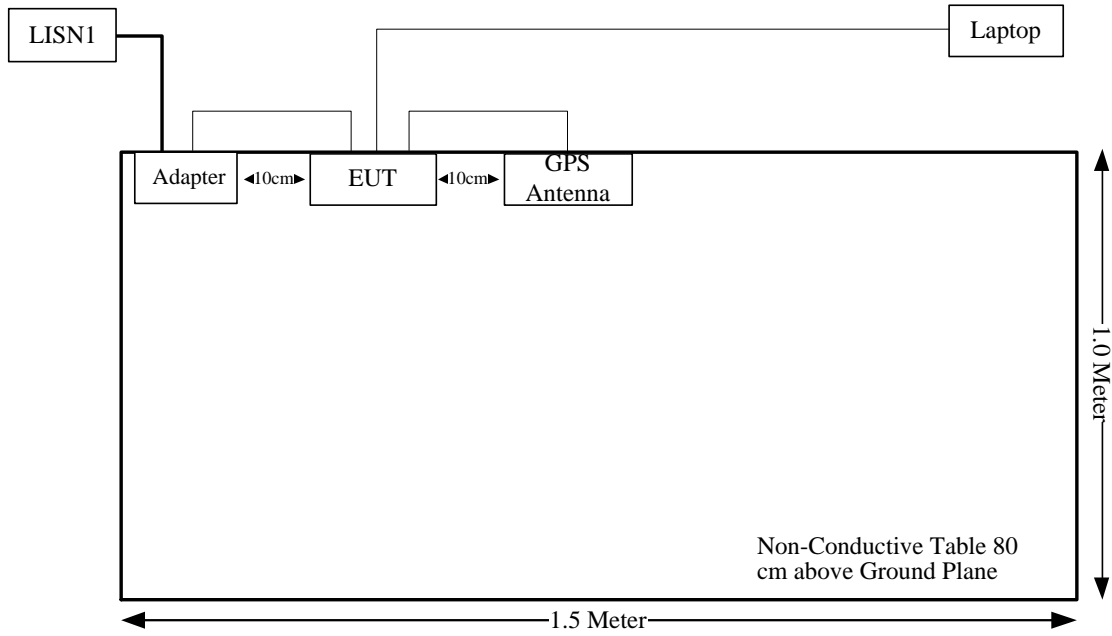

Spurious Emissions:

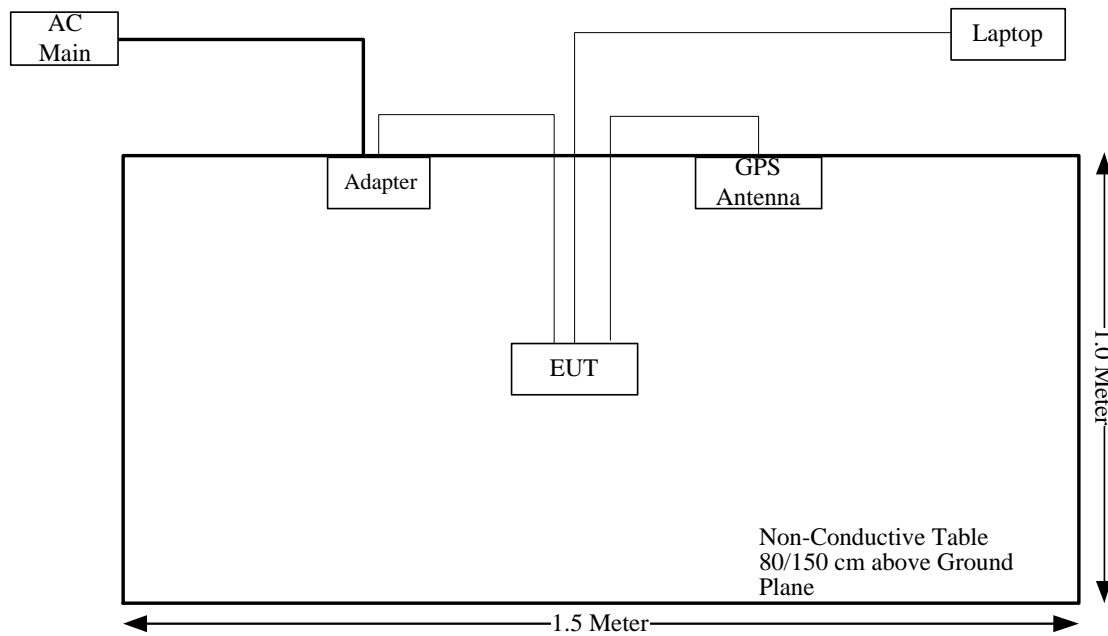

1.3 Measurement Uncertainty

Otherwise required by the applicant or Product Regulations, Decision Rule in this report did not consider the uncertainty. The extended uncertainty given in this report is obtained by combining the standard uncertainty times the coverage factor K with the 95% confidence interval.

Parameter	Measurement Uncertainty
Occupied Channel Bandwidth	±5 %
RF output power, conducted	±0.61dB
Power Spectral Density, conducted	±0.61 dB
Unwanted Emissions, radiated	30M~200MHz: 4.15 dB,200M~1GHz: 5.61 dB,1G~6GHz: 5.14 dB, 6G~18GHz: 5.93 dB,18G~26.5G:5.47 dB,26.5G~40G:5.63 dB
Unwanted Emissions, conducted	±1.26 dB
Temperature	±1 °C
Humidity	±5%
DC and low frequency voltages	±0.4%
Duty Cycle	1%
AC Power Lines Conducted Emission	2.8 dB (150 kHz to 30 MHz)

2. SUMMARY OF TEST RESULTS

Standard(s) Section	Test Items	Result
§15.207(a)	AC line conducted emissions	Compliant
§15.205, §15.209, §15.247(d)	Spurious Emissions	Compliant
§15.247 (a)(2)	6 dB Bandwidth	Compliant
§15.247(b)(3)	Maximum Conducted Output Power	Compliant
§15.247(d)	100 kHz Bandwidth of Frequency Band Edge	Compliant
§15.247(e)	Power Spectral Density	Compliant
§15.203	Antenna Requirement	Compliant
§15.247 (i) & §1.1310 & §2.1091	Maximum Permissible Exposure (MPE)	Compliant

3. REQUIREMENTS AND TEST PROCEDURES

3.1 AC Line Conducted Emissions

3.1.1 Applicable Standard

FCC §15.207(a).

(a) Except as shown in paragraphs (b) and (c) of this section, for an intentional radiator that is designed to be connected to the public utility (AC) power line, the radio frequency voltage that is conducted back onto the AC power line on any frequency or frequencies, within the band 150 kHz to 30 MHz, shall not exceed the limits in the following table, as measured using a 50 μ H/50 ohms line impedance stabilization network (LISN). Compliance with the provisions of this paragraph shall be based on the measurement of the radio frequency voltage between each power line and ground at the power terminal. The lower limit applies at the boundary between the frequency ranges.

Frequency of emission (MHz)	Conducted limit (dB μ V)	
	Quasi-peak	Average
0.15-0.5	66 to 56*	56 to 46*
0.5-5	56	46
5-30	60	50

*Decreases with the logarithm of the frequency.

(b) The limit shown in paragraph (a) of this section shall not apply to carrier current systems operating as intentional radiators on frequencies below 30 MHz. In lieu thereof, these carrier current systems shall be subject to the following standards:

(1) For carrier current system containing their fundamental emission within the frequency band 535-1705 kHz and intended to be received using a standard AM broadcast receiver: no limit on conducted emissions.

(2) For all other carrier current systems: 1000 μ V within the frequency band 535-1705 kHz, as measured using a 50 μ H/50 ohms LISN.

(3) Carrier current systems operating below 30 MHz are also subject to the radiated emission limits in §15.205, §15.209, §15.221, §15.223, or §15.227, as appropriate.

(c) Measurements to demonstrate compliance with the conducted limits are not required for devices which only employ battery power for operation and which do not operate from the AC power lines or contain provisions for operation while connected to the AC power lines. Devices that include, or make provisions for, the use of battery chargers which permit operating while charging, AC adapters or battery eliminators or that connect to the AC power lines indirectly, obtaining their power through another device which is connected to the AC power lines, shall be tested to demonstrate compliance with the conducted limits.

3.1.2 EUT Setup

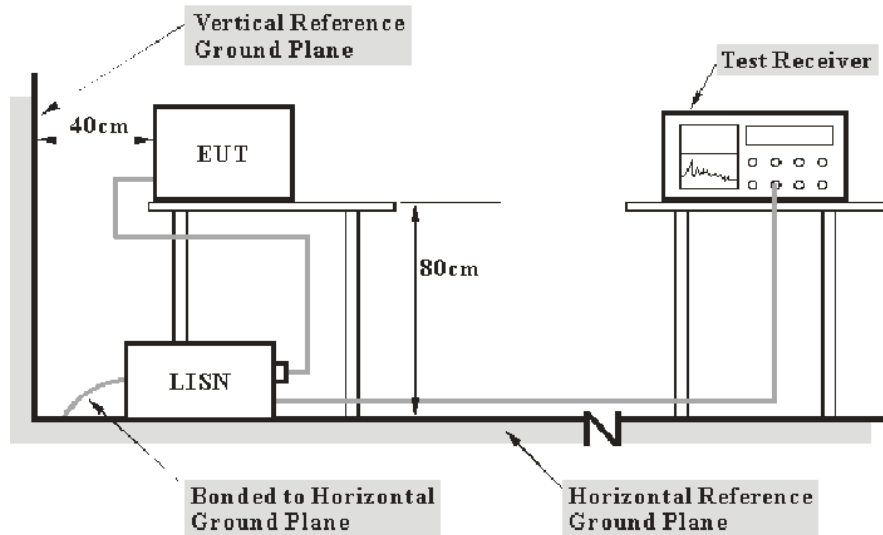

- Note: 1. Support units were connected to second LISN.
 2. Both of LISNs (AMN) 80 cm from EUT and at the least 80 cm from other units and other metal planes support units.

The setup of EUT is according with per ANSI C63.10-2013 measurement procedure. The specification used was with the FCC Part 15.207 limits.

The spacing between the peripherals was 10 cm.

The adapter or EUT was connected to the main LISN with a 120 V/60 Hz AC power source.

3.1.3 EMI Test Receiver Setup

The EMI test receiver was set to investigate the spectrum from 150 kHz to 30 MHz.

During the conducted emission test, the EMI test receiver was set with the following configurations:

Frequency Range	IF B/W
150 kHz – 30 MHz	9 kHz

3.1.4 Test Procedure

The frequency and amplitude of the six highest ac power-line conducted emissions relative to the limit, measured over all the current-carrying conductors of the EUT power cords, and the operating frequency or frequency to which the EUT is tuned (if appropriate), should be reported, unless such emissions are more than 20 dB below the limit. AC power-line conducted emissions measurements are to be separately carried out only on each of the phase (“hot”) line(s) and (if used) on the neutral line(s), but not on the ground [protective earth] line(s). If less than six emission frequencies are within 20 dB of the limit, then the noise level of the measuring instrument at representative frequencies should be reported. The specific conductor of the power-line cord for each of the reported emissions should be identified. Measure the six highest emissions with respect to the limit on each current-carrying conductor of each power cord associated with the EUT (but not the power cords of associated or peripheral equipment that are part of the test configuration). Then, report the six highest emissions with respect to the limit from among all the measurements identifying the frequency and specific current-carrying conductor identified with the emission. The six highest emissions should be reported for each of the current-carrying conductors, or the six highest emissions may be reported over all the current-carrying conductors.

3.1.5 Corrected Amplitude & Margin Calculation

The basic equation is as follows:

Result = Reading + Factor

Factor = attenuation caused by cable loss + voltage division factor of AMN

The “**Margin**” column of the following data tables indicates the degree of compliance within the applicable limit. The equation for margin calculation is as follows:

Margin = Limit – Result

3.2 Radiation Spurious Emissions

3.2.1 Applicable Standard

FCC §15.247 (d);

In any 100 kHz bandwidth outside the frequency band in which the spread spectrum or digitally modulated intentional radiator is operating, the radio frequency power that is produced by the intentional radiator shall be at least 20 dB below that in the 100 kHz bandwidth within the band that contains the highest level of the desired power, based on either an RF conducted or a radiated measurement, provided the transmitter demonstrates compliance with the peak conducted power limits. If the transmitter complies with the conducted power limits based on the use of RMS averaging over a time interval, as permitted under paragraph (b)(3) of this section, the attenuation required under this paragraph shall be 30 dB instead of 20 dB. Attenuation below the general limits specified in §15.209(a) is not required. In addition, radiated emissions which fall in the restricted bands, as defined in §15.205(a), must also comply with the radiated emission limits specified in §15.209(a) (see §15.205(c)).

3.2.2 EUT Setup

Below 1GHz:

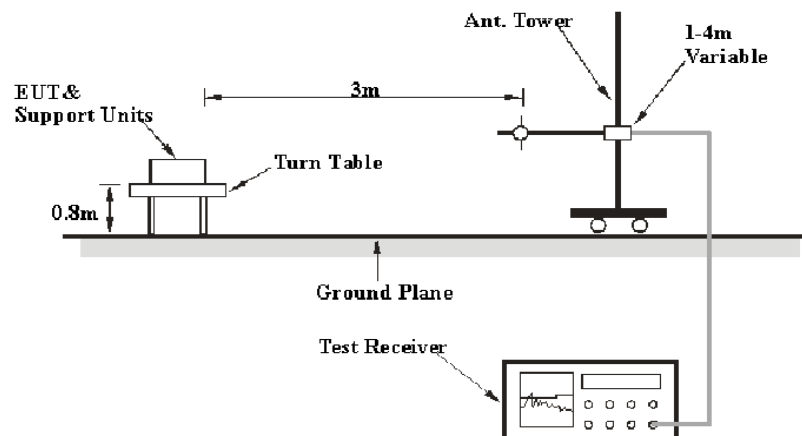

Above 1GHz:

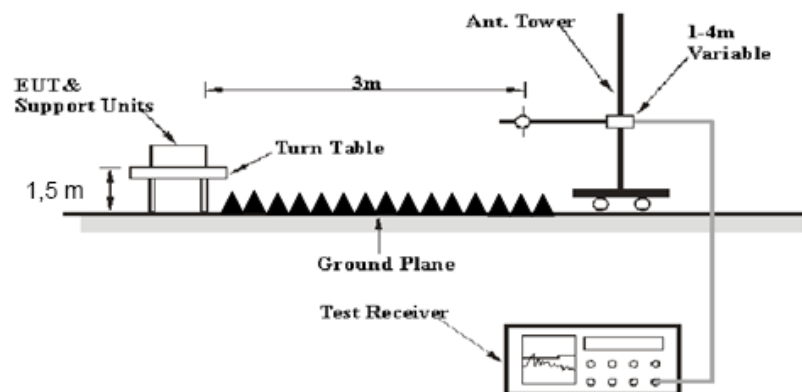

The radiated emissions were performed in the 3 meters distance, using the setup accordance with the ANSI C63.10-2013. The specification used was the FCC 15.209, and FCC 15.247 limits.

The external I/O cables were draped along the test table and formed a bundle 30 to 40 cm long in the middle.

The spacing between the peripherals was 10 cm.

3.2.3 EMI Test Receiver & Spectrum Analyzer Setup

During the radiated emission test, the EMI test receiver & Spectrum Analyzer Setup were set with the following configurations:

30MHz-1000MHz:

Detector	RBW	Video B/W	IF B/W
QP	120 kHz	300 kHz	120kHz

1GHz- 25GHz:

Detector	RBW	Video B/W
PK	1MHz	3 MHz
Average	1MHz	3 MHz

If the maximized peak measured value complies with under the QP/Average limit more than 6dB, then it is unnecessary to perform an QP/Average measurement.

3.2.4 Test Procedure

Maximizing procedure was performed on the highest emissions to ensure that the EUT complied with all installation combinations.

Data was recorded in Quasi-peak detection mode for frequency range of 30 MHz-1 GHz, peak and Average detection modes for frequencies above 1 GHz.

3.2.5 Corrected Amplitude & Margin Calculation

The basic equation is as follows:

Result = Reading + Factor

Factor = Antenna Factor + Cable Loss- Amplifier Gain

The “**Margin**” column of the following data tables indicates the degree of compliance within the applicable limit. The equation for margin calculation is as follows:

Margin = Limit – Result

3.3 6 dB Emission Bandwidth:

3.3.1 Applicable Standard

FCC §15.247 (a)(2)

Systems using digital modulation techniques may operate in the 902-928 MHz, 2400-2483.5 MHz, and 5725-5850 MHz bands. The minimum 6 dB bandwidth shall be at least 500 kHz.

3.3.2 EUT Setup

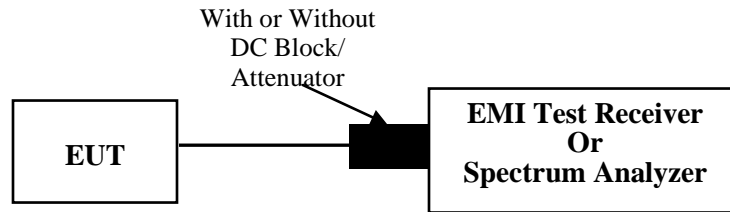

3.3.3 Test Procedure

According to ANSI C63.10-2013 Section 11.8

- a) Set RBW = 100 kHz.
- b) Set the video bandwidth (VBW) $\geq 3 \times$ RBW.
- c) Detector = Peak.
- d) Trace mode = max hold.
- e) Sweep = auto couple.
- f) Allow the trace to stabilize.
- g) Measure the maximum width of the emission that is constrained by the frequencies associated with the two outermost amplitude points (upper and lower frequencies) that are attenuated by 6 dB relative to the maximum level measured in the fundamental emission.

3.4 Maximum peak conducted output power:

3.4.1 Applicable Standard

FCC §15.247 (b)(3)

For systems using digital modulation in the 902-928 MHz, 2400-2483.5 MHz, and 5725-5850 MHz bands: 1 Watt. As an alternative to a peak power measurement, compliance with the one Watt limit can be based on a measurement of the maximum conducted output power. Maximum Conducted Output Power is defined as the total transmit power delivered to all antennas and antenna elements averaged across all symbols in the signaling alphabet when the transmitter is operating at its maximum power control level. Power must be summed across all antennas and antenna elements. The average must not include any time intervals during which the transmitter is off or is transmitting at a reduced power level. If multiple modes of operation are possible (e.g., alternative modulation methods), the maximum conducted output power is the highest total transmit power occurring in any mode.

3.4.2 EUT Setup

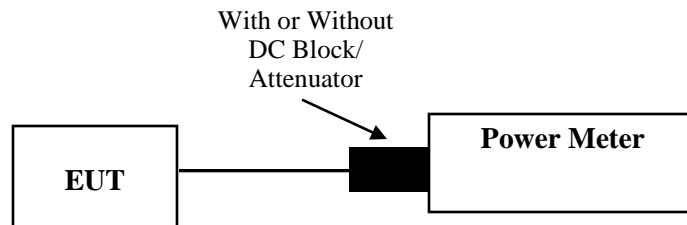

3.4.3 Test Procedure

According to ANSI C63.10-2013 Section 11.9.1.3

The maximum peak conducted output power may be measured using a broadband peak RF power meter. The power meter shall have a video bandwidth that is greater than or equal to the DTS bandwidth and shall use a fast-responding diode detector.

- a) Set the EUT in transmitting mode.
- b) Remove the antenna from the EUT and then connect a low loss RF cable from the antenna port to test equipment.
- c) Add a correction factor to the display.
- d) Set the power meter to test peak output power, record the result.

3.5 Maximum power spectral density:

3.5.1 Applicable Standard

FCC §15.247 (e)

For digitally modulated systems, the power spectral density conducted from the intentional radiator to the antenna shall not be greater than 8 dBm in any 3 kHz band during any time interval of continuous transmission. This power spectral density shall be determined in accordance with the provisions of paragraph (b) of this section. The same method of determining the conducted output power shall be used to determine the power spectral density.

3.5.2 EUT Setup

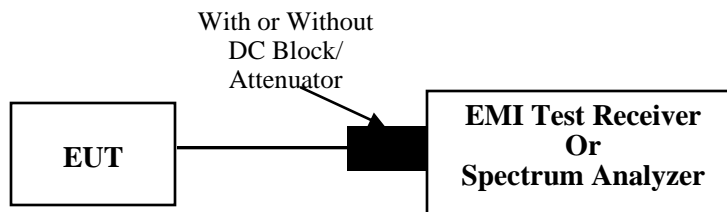

3.5.3 Test Procedure

According to ANSI C63.10-2013 Section 11.10.2

- a) Set analyzer center frequency to DTS channel center frequency.
- b) Set the span to 1.5 times the DTS bandwidth.
- c) Set the RBW to $3 \text{ kHz} \leq \text{RBW} \leq 100 \text{ kHz}$.
- d) Set the VBW $\geq [3 \cdot \text{RBW}]$.
- e) Detector = peak.
- f) Sweep time = auto couple.
- g) Trace mode = max hold.
- h) Allow trace to fully stabilize.
- i) Use the peak marker function to determine the maximum amplitude level within the RBW.
- j) If measured value exceeds requirement, then reduce RBW (but no less than 3 kHz) and repeat.

3.6 100 kHz Bandwidth of Frequency Band Edge:

3.6.1 Applicable Standard

FCC §15.247 (d);

In any 100 kHz bandwidth outside the frequency band in which the spread spectrum or digitally modulated intentional radiator is operating, the radio frequency power that is produced by the intentional radiator shall be at least 20 dB below that in the 100 kHz bandwidth within the band that contains the highest level of the desired power, based on either an RF conducted or a radiated measurement, provided the transmitter demonstrates compliance with the peak conducted power limits. If the transmitter complies with the conducted power limits based on the use of RMS averaging over a time interval, as permitted under paragraph (b)(3) of this section, the attenuation required under this paragraph shall be 30 dB instead of 20 dB. Attenuation below the general limits specified in §15.209(a) is not required. In addition, radiated emissions which fall in the restricted bands, as defined in §15.205(a), must also comply with the radiated emission limits specified in §15.209(a) (see §15.205(c)).

3.6.2 EUT Setup

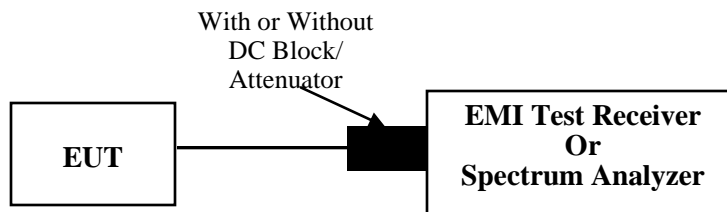

3.6.3 Test Procedure

According to ANSI C63.10-2013 Section 11.11

- a) Set the center frequency and span to encompass frequency range to be measured.
- b) Set the RBW = 100 kHz.
- c) Set the VBW $\geq [3 \times \text{RBW}]$.
- d) Detector = peak.
- e) Sweep time = auto couple.
- f) Trace mode = max hold.
- g) Allow trace to fully stabilize.
- h) Use the peak marker function to determine the maximum amplitude level.

Ensure that the amplitude of all unwanted emissions outside of the authorized frequency band (excluding restricted frequency bands) is attenuated by at least the minimum requirements specified in 11.11. Report the three highest emissions relative to the limit.

3.7 Duty Cycle:

3.7.1 EUT Setup

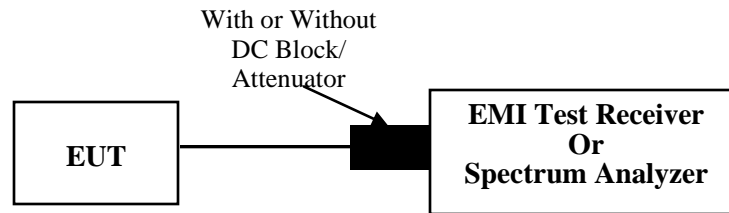

3.7.2 Test Procedure

According to ANSI C63.10-2013 Section 11.6

The zero-span mode on a spectrum analyzer or EMI receiver if the response time and spacing between bins on the sweep are sufficient to permit accurate measurements of the ON and OFF times of the transmitted signal:

- 1) Set the center frequency of the instrument to the center frequency of the transmission.
- 2) Set $RBW \geq OBW$ if possible; otherwise, set RBW to the largest available value.
- 3) Set $VBW \geq RBW$. Set detector = peak or average.
- 4) The zero-span measurement method shall not be used unless both RBW and VBW are $> 50/T$ and the number of sweep points across duration T exceeds 100. (For example, if VBW and/or RBW are limited to 3 MHz, then the zero-span method of measuring the duty cycle shall not be used if $T \leq 16.7 \mu s$.)

3.8 Antenna Requirement

3.8.1 Applicable Standard

FCC §15.203

An intentional radiator shall be designed to ensure that no antenna other than that furnished by the responsible party shall be used with the device. The use of a permanently attached antenna or of an antenna that uses a unique coupling to the intentional radiator shall be considered sufficient to comply with the provisions of this section. The manufacturer may design the unit so that a broken antenna can be replaced by the user, but the use of a standard antenna jack or electrical connector is prohibited. This requirement does not apply to carrier current devices or to devices operated under the provisions of §§15.211, 15.213, 15.217, 15.219, 15.221, or §15.236. Further, this requirement does not apply to intentional radiators that must be professionally installed, such as perimeter protection systems and some field disturbance sensors, or to other intentional radiators which, in accordance with §15.31(d), must be measured at the installation site. However, the installer shall be responsible for ensuring that the proper antenna is employed so that the limits in this part are not exceeded.

3.8.2 Judgment

Please refer to the Antenna Information detail in Section 1.

4. Test DATA AND RESULTS

4.1 AC Line Conducted Emissions

Serial Number:	CR22040013-RF-S1	Test Date:	2022-04-26
Test Site:	CE	Test Mode:	Transmitting
Tester:	Nick Tang	Test Result:	Pass

Environmental Conditions:

Temperature: (°C)	26.5	Relative Humidity: (%)	60	ATM Pressure: (kPa)	100.1
----------------------	------	------------------------------	----	------------------------	-------

Test Equipment List and Details:

Manufacturer	Description	Model	Serial Number	Calibration Date	Calibration Due Date
R&S	LISN	ENV216	101134	2022-04-01	2023-03-31
R&S	EMI Test Receiver	ESR3	102726	2021-07-22	2022-07-21
MICRO-COAX	Coaxial Cable	UTIFLEX	C-0200-01	2021-08-08	2022-08-07
Audix	Test Software	E3	190306 (V9)	N/A	N/A

** Statement of Traceability: China Certification ICT Co., Ltd (Dongguan) attests that all calibrations have been performed, traceable to National Primary Standards and International System of Units (SI).*

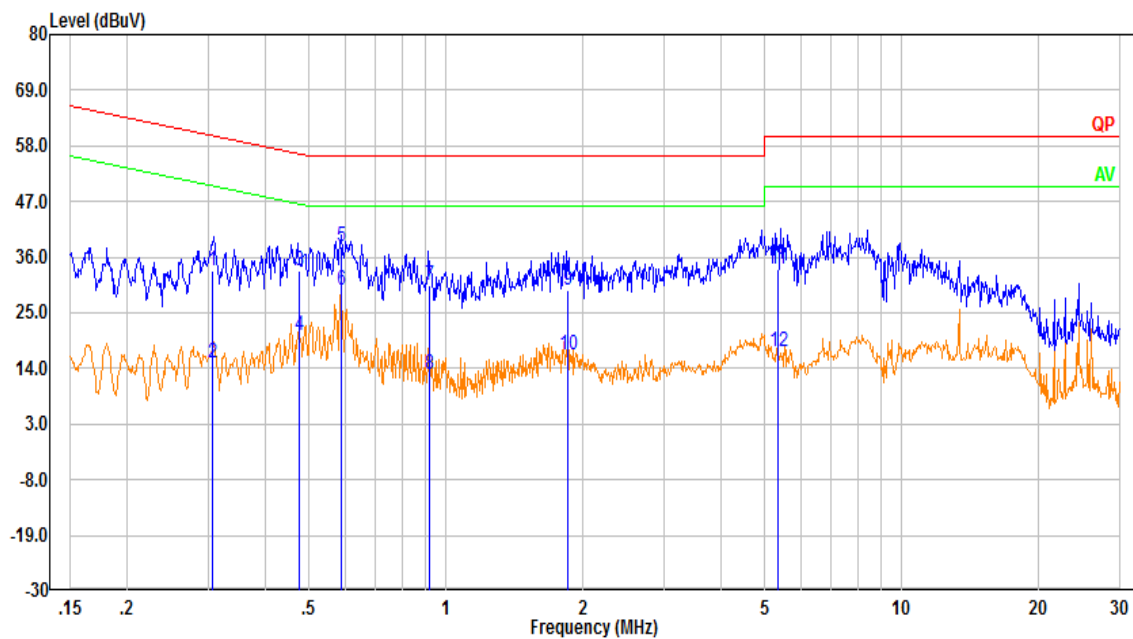
Line:

No.	Frequency (MHz)	Reading (dB μ V)	Factor (dB)	Result (dB μ V)	Limit (dB μ V)	Margin (dB)	Detector
1	0.307	23.62	9.61	33.23	60.06	26.83	QP
2	0.307	5.39	9.61	15.00	50.06	35.06	Average
3	0.476	23.76	9.61	33.37	56.42	23.05	QP
4	0.476	11.07	9.61	20.68	46.42	25.74	Average
5	0.590	28.54	9.62	38.16	56.00	17.84	QP
6	0.590	19.75	9.62	29.37	46.00	16.63	Average
7	0.922	20.69	9.62	30.31	56.00	25.69	QP
8	0.922	3.35	9.62	12.97	46.00	33.03	Average
9	1.850	19.89	9.63	29.51	56.00	26.49	QP
10	1.850	7.16	9.63	16.79	46.00	29.21	Average
11	5.341	24.13	9.66	33.79	60.00	26.21	QP
12	5.341	7.79	9.66	17.45	50.00	32.55	Average

Neutral:

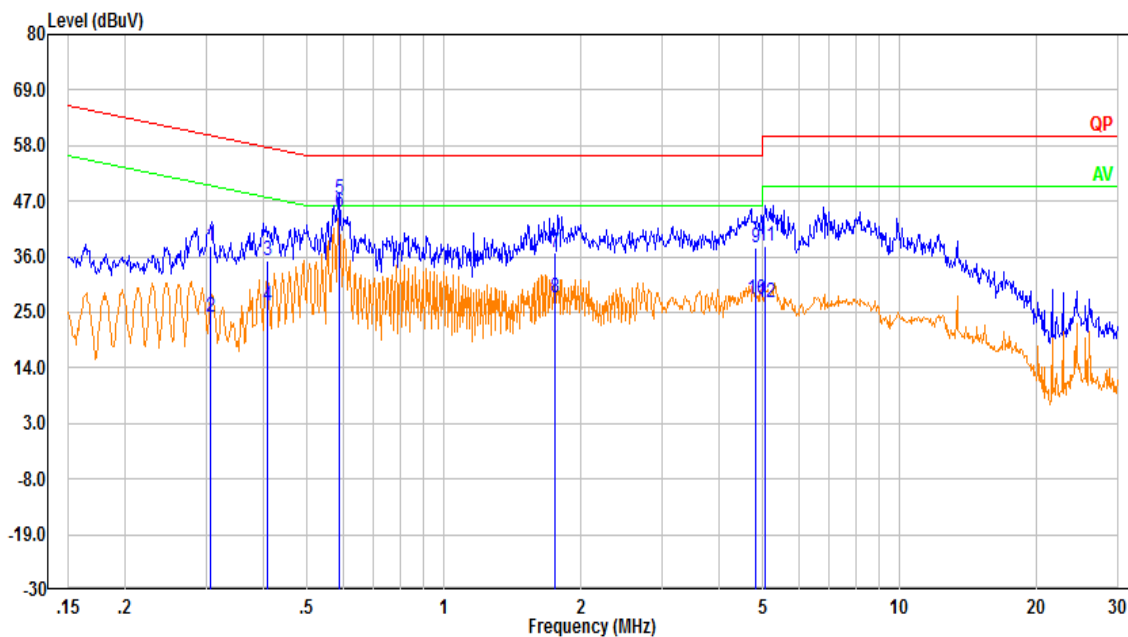

No.	Frequency (MHz)	Reading (dBμV)	Factor (dB)	Result (dBμV)	Limit (dBμV)	Margin (dB)	Detector
1	0.307	28.58	9.61	38.19	60.05	21.86	QP
2	0.307	14.49	9.61	24.10	50.05	25.95	Average
3	0.411	25.78	9.61	35.39	57.63	22.24	QP
4	0.411	16.74	9.61	26.35	47.63	21.28	Average
5	0.589	37.92	9.62	47.54	56.00	8.46	QP
6	0.589	35.26	9.62	44.88	46.00	1.12	Average
7	1.754	27.22	9.63	36.85	56.00	19.15	QP
8	1.754	18.35	9.63	27.98	46.00	18.02	Average
9	4.820	28.09	9.66	37.74	56.00	18.26	QP
10	4.820	17.80	9.66	27.46	46.00	18.54	Average
11	5.081	28.44	9.66	38.10	60.00	21.90	QP
12	5.081	17.26	9.66	26.92	50.00	23.08	Average

4.2 Radiation Spurious Emissions

Serial Number:	CR22040013-RF-S1	Test Date:	2022-04-27~2022-04-29
Test Site:	966-1,966-2	Test Mode:	Transmitting
Tester:	Veyo Zhang, Tommy Luo	Test Result:	Pass

Environmental Conditions:					
Temperature: (°C)	20.1~24.8	Relative Humidity: (%)	62~69	ATM Pressure: (kPa)	101~101.1

Test Equipment List and Details:

Manufacturer	Description	Model	Serial Number	Calibration Date	Calibration Due Date
Sunol Sciences	Antenna	JB6	A082520-5	2020-10-19	2023-10-18
R&S	EMI Test Receiver	ESR3	102724	2021-07-22	2022-07-21
TIMES MICROWAVE	Coaxial Cable	LMR-600-UltraFlex	C-0470-02	2021-07-18	2022-07-17
TIMES MICROWAVE	Coaxial Cable	LMR-600-UltraFlex	C-0780-01	2021-07-18	2022-07-17
Sonoma	Amplifier	310N	186165	2021-07-18	2022-07-17
Audix	Test Software	E3	201021 (V9)	N/A	N/A
ETS-Lindgren	Horn Antenna	3115	9912-5985	2020-10-13	2023-10-12
R&S	Spectrum Analyzer	FSV40	101591	2021-07-22	2022-07-21
MICRO-COAX	Coaxial Cable	UFA210A-1-1200-70U300	217423-008	2021-08-08	2022-08-07
MICRO-COAX	Coaxial Cable	UFA210A-1-2362-300300	235780-001	2021-08-08	2022-08-07
Mini	Pre-amplifier	ZVA-183-S+	5969001149	2021-11-10	2022-11-09
Audix	Test Software	E3	201021 (V9)	N/A	N/A
PASTERNAK	Horn Antenna	PE9852/2F-20	112002	2021-02-05	2024-02-04
AH	Preamplifier	PAM-1840VH	190	2021-11-19	2022-11-18
MICRO-COAX	Coaxial Cable	UFB142A-1-2362-200200	235772-001	2021-08-08	2022-08-07
E-Microwave	Band Rejection Filter	2400-2483.5MHz	OE01902424	2021-08-08	2022-08-07
Mini Circuits	High Pass Filter	VHF-6010+	31119	2021-08-08	2022-08-07
Mini Circuits	High Pass Filter	VHF-3100+	31251	2021-08-08	2022-08-07

* Statement of Traceability: China Certification ICT Co., Ltd (Dongguan) attests that all calibrations have been performed, traceable to National Primary Standards and International System of Units (SI).

Test Data:

Please refer to the below table and plots.

Note: The device can be mounted in multiple orientations, test was performed with X, Y, Z Axis according to C63.10 figure 8, the worst orientation was photographed and its data was recorded.

1) 30MHz-1GHz(802.11b Low channel was the worst)

Horizontal:

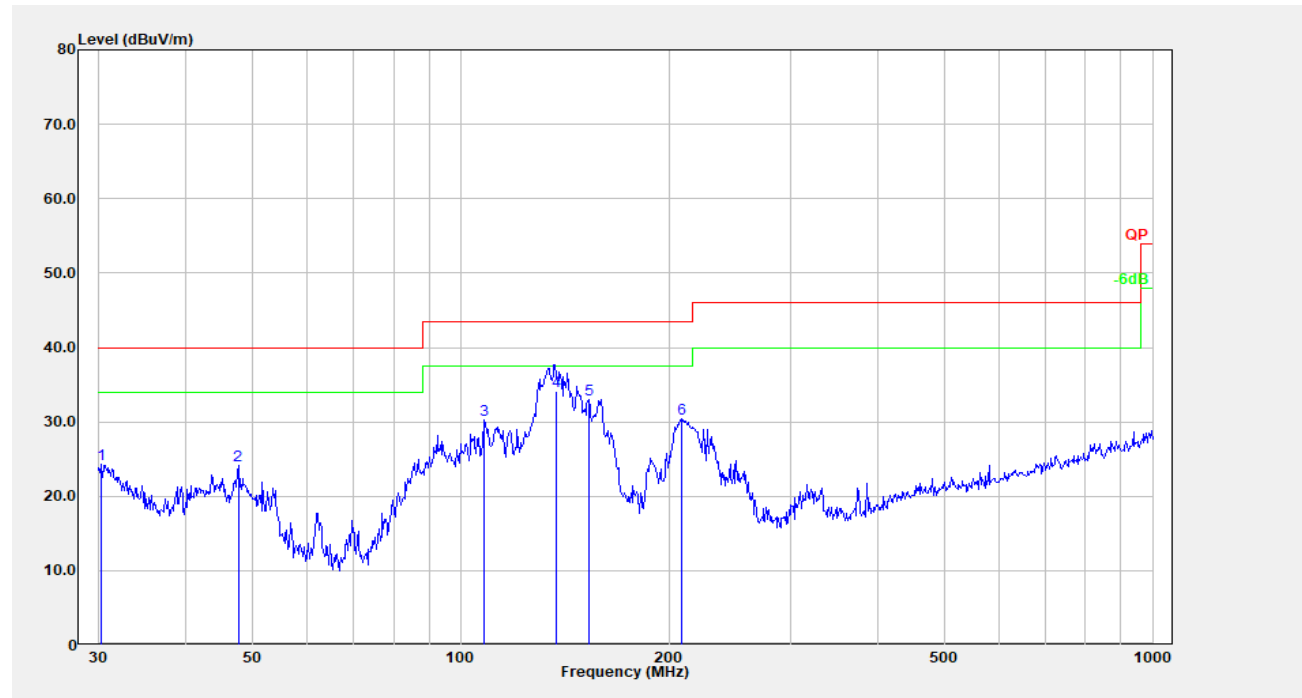

No.	Frequency (MHz)	Reading (dB μ V)	Factor (dB/m)	Result (dB μ V/m)	Limit (dB μ V/m)	Margin (dB)	Detector
1	30.211	28.29	-3.95	24.34	40.00	15.66	Peak
2	47.659	40.13	-16.04	24.09	40.00	15.91	Peak
3	107.888	43.29	-12.99	30.30	43.50	13.20	Peak
4	137.164	46.16	-11.97	34.20	43.50	9.30	QP
5	153.200	45.34	-12.30	33.04	43.50	10.46	Peak
6	208.580	43.00	-12.58	30.42	43.50	13.08	Peak

Vertical:

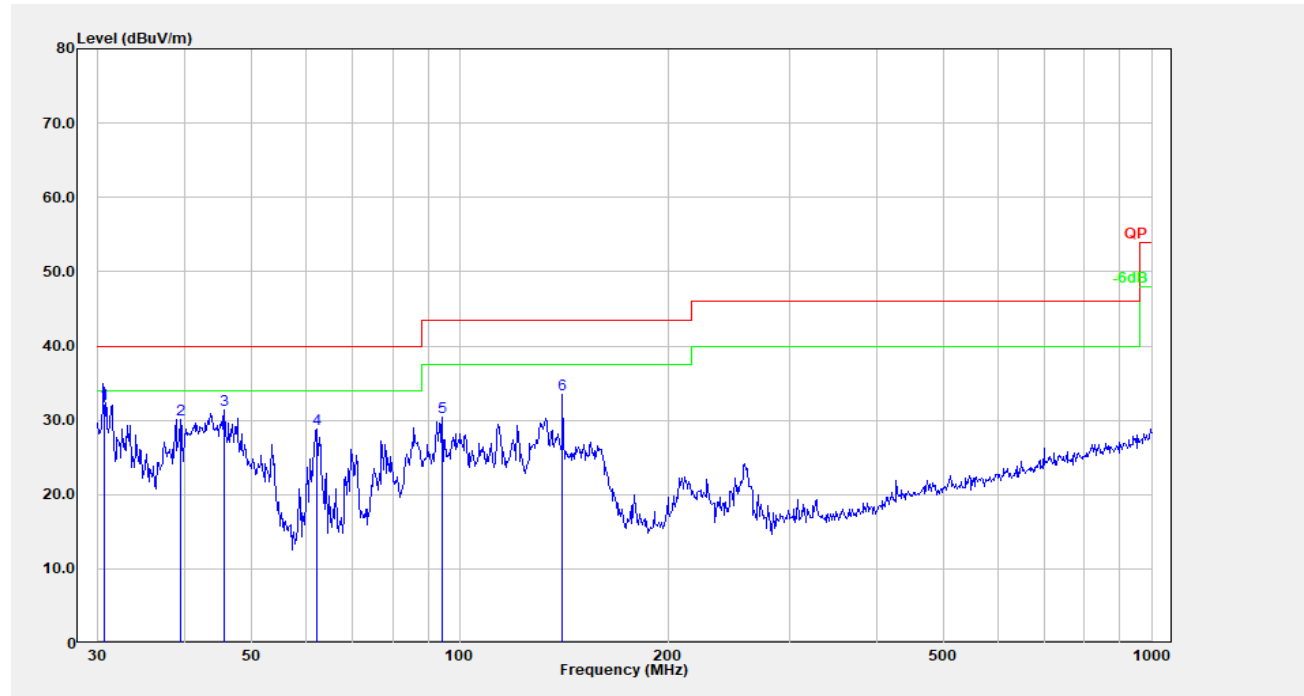

No.	Frequency (MHz)	Reading (dBμV)	Factor (dB/m)	Result (dBμV/m)	Limit (dBμV/m)	Margin (dB)	Detector
1	30.628	36.52	-4.27	32.24	40.00	7.76	QP
2	39.437	41.21	-11.07	30.14	40.00	9.86	Peak
3	45.695	46.33	-14.88	31.45	40.00	8.55	Peak
4	62.213	46.23	-17.46	28.77	40.00	11.23	Peak
5	94.428	46.53	-16.04	30.49	43.50	13.01	Peak
6	140.835	45.67	-12.18	33.49	43.50	10.01	Peak

**1-25GHz:
802.11b Mode:**

Frequency (MHz)	Receiver		Polar (H/V)	Factor (dB/m)	Result (dB μ V/m)	Limit (dB μ V/m)	Margin (dB)
	Reading (dB μ V)	Detector					
Low Channel: 2412 MHz							
2412.00	56.50	PK	H	31.53	88.03	N/A	N/A
2412.00	53.66	AV	H	31.53	85.19	N/A	N/A
2412.00	71.39	PK	V	31.53	102.92	N/A	N/A
2412.00	68.63	AV	V	31.53	100.16	N/A	N/A
2390.00	27.09	PK	V	31.46	58.55	74.00	15.45
2390.00	14.24	AV	V	31.46	45.70	54.00	8.30
4824.00	40.25	PK	V	10.94	51.19	74.00	22.81
4824.00	34.67	AV	V	10.94	45.61	54.00	8.39
7236.00	34.54	PK	V	14.44	48.98	74.00	25.02
7236.00	22.38	AV	V	14.44	36.82	54.00	17.18
Middle Channel: 2437MHz							
2437.00	57.52	PK	H	31.60	89.12	N/A	N/A
2437.00	54.62	AV	H	31.60	86.22	N/A	N/A
2437.00	70.48	PK	V	31.60	102.08	N/A	N/A
2437.00	67.74	AV	V	31.60	99.34	N/A	N/A
4874.00	40.47	PK	V	11.05	51.52	74.00	22.48
4874.00	34.83	AV	V	11.05	45.88	54.00	8.12
7311.00	34.16	PK	V	14.80	48.96	74.00	25.04
7311.00	22.05	AV	V	14.80	36.85	54.00	17.15
High Channel: 2462MHz							
2462.00	58.53	PK	H	31.63	90.16	N/A	N/A
2462.00	55.70	AV	H	31.63	87.33	N/A	N/A
2462.00	71.84	PK	V	31.63	103.47	N/A	N/A
2462.00	68.60	AV	V	31.63	100.23	N/A	N/A
2483.50	37.85	PK	V	31.64	69.49	74.00	4.51
2483.50	14.27	AV	V	31.64	45.91	54.00	8.09
4924.00	41.52	PK	V	11.18	52.70	74.00	21.30
4924.00	35.34	AV	V	11.18	46.52	54.00	7.48
7386.00	33.91	PK	V	14.89	48.80	74.00	25.20
7386.00	21.76	AV	V	14.89	36.65	54.00	17.35

802.11g Mode:

Frequency (MHz)	Receiver		Polar (H/V)	Factor (dB/m)	Result (dB μ V/m)	Limit (dB μ V/m)	Margin (dB)
	Reading (dB μ V)	Detector					
Low Channel: 2412 MHz							
2412.00	62.88	PK	H	31.53	94.41	N/A	N/A
2412.00	53.98	AV	H	31.53	85.51	N/A	N/A
2412.00	74.38	PK	V	31.53	105.91	N/A	N/A
2412.00	65.34	AV	V	31.53	96.87	N/A	N/A
2390.00	32.81	PK	V	31.46	64.27	74.00	9.73
2390.00	17.88	AV	V	31.46	49.34	54.00	4.66
4824.00	39.17	PK	V	10.94	50.11	74.00	23.89
4824.00	24.50	AV	V	10.94	35.44	54.00	18.56
7236.00	33.93	PK	V	14.44	48.37	74.00	25.63
7236.00	21.79	AV	V	14.44	36.23	54.00	17.77
Middle Channel: 2437MHz							
2437.00	61.70	PK	H	31.60	93.30	N/A	N/A
2437.00	52.91	AV	H	31.60	84.51	N/A	N/A
2437.00	74.11	PK	V	31.60	105.71	N/A	N/A
2437.00	64.93	AV	V	31.60	96.53	N/A	N/A
4874.00	40.01	PK	V	11.05	51.06	74.00	22.94
4874.00	25.64	AV	V	11.05	36.69	54.00	17.31
7311.00	34.70	PK	V	14.80	49.50	74.00	24.50
7311.00	22.56	AV	V	14.80	37.36	54.00	16.64
High Channel: 2462MHz							
2462.00	60.32	PK	H	31.63	91.95	N/A	N/A
2462.00	51.08	AV	H	31.63	82.71	N/A	N/A
2462.00	74.01	PK	V	31.63	105.64	N/A	N/A
2462.00	65.04	AV	V	31.63	96.67	N/A	N/A
2483.50	34.24	PK	V	31.64	65.88	74.00	8.12
2483.50	20.07	AV	V	31.64	51.71	54.00	2.29
4924.00	40.79	PK	V	11.18	51.97	74.00	22.03
4924.00	25.51	AV	V	11.18	36.69	54.00	17.31
7386.00	34.23	PK	V	14.89	49.12	74.00	24.88
7386.00	22.07	AV	V	14.89	36.96	54.00	17.04

802.11n ht20 Mode:

Frequency (MHz)	Receiver		Polar (H/V)	Factor (dB/m)	Result (dB μ V/m)	Limit (dB μ V/m)	Margin (dB)
	Reading (dB μ V)	Detector					
Low Channel: 2412 MHz							
2412.00	63.29	PK	H	31.53	94.82	N/A	N/A
2412.00	53.30	AV	H	31.53	84.83	N/A	N/A
2412.00	76.63	PK	V	31.53	108.16	N/A	N/A
2412.00	67.51	AV	V	31.53	99.04	N/A	N/A
2390.00	36.59	PK	V	31.46	68.05	74.00	5.95
2390.00	19.95	AV	V	31.46	51.41	54.00	2.59
4824.00	39.28	PK	V	10.94	50.22	74.00	23.78
4824.00	24.80	AV	V	10.94	35.74	54.00	18.26
7236.00	34.59	PK	V	14.44	49.03	74.00	24.97
7236.00	22.34	AV	V	14.44	36.78	54.00	17.22
Middle Channel: 2437 MHz							
2437.00	62.18	PK	H	31.60	93.78	N/A	N/A
2437.00	52.93	AV	H	31.60	84.53	N/A	N/A
2437.00	76.92	PK	V	31.60	108.52	N/A	N/A
2437.00	67.48	AV	V	31.60	99.08	N/A	N/A
4874.00	39.57	PK	V	11.05	50.62	74.00	23.38
4874.00	24.43	AV	V	11.05	35.48	54.00	18.52
7311.00	34.72	PK	V	14.80	49.52	74.00	24.48
7311.00	22.26	AV	V	14.80	37.06	54.00	16.94
High Channel: 2462MHz							
2462.00	62.54	PK	H	31.63	94.17	N/A	N/A
2462.00	53.03	AV	H	31.63	84.66	N/A	N/A
2462.00	76.12	PK	V	31.63	107.75	N/A	N/A
2462.00	66.84	AV	V	31.63	98.47	N/A	N/A
2483.50	34.84	PK	V	31.64	66.48	74.00	7.52
2483.50	18.57	AV	V	31.64	50.21	54.00	3.79
4924.00	39.26	PK	V	11.18	50.44	74.00	23.56
4924.00	24.17	AV	V	11.18	35.35	54.00	18.65
7386.00	33.93	PK	V	14.89	48.82	74.00	25.18
7386.00	21.55	AV	V	14.89	36.44	54.00	17.56

802.11n ht40 Mode:

Frequency (MHz)	Receiver		Polar (H/V)	Factor (dB/m)	Result (dB μ V/m)	Limit (dB μ V/m)	Margin (dB)
	Reading (dB μ V)	Detector					
Low Channel: 2422 MHz							
2422.00	58.75	PK	H	31.56	90.31	N/A	N/A
2422.00	48.14	AV	H	31.56	79.70	N/A	N/A
2422.00	73.33	PK	V	31.56	104.89	N/A	N/A
2422.00	62.74	AV	V	31.56	94.30	N/A	N/A
2390.00	38.82	PK	V	31.46	70.28	74.00	3.72
2390.00	21.66	AV	V	31.46	53.12	54.00	0.88
4844.00	35.79	PK	V	10.96	46.75	74.00	27.25
4844.00	22.80	AV	V	10.96	33.76	54.00	20.24
7266.00	34.63	PK	V	14.63	49.26	74.00	24.74
7266.00	22.35	AV	V	14.63	36.98	54.00	17.02
Middle Channel: 2437 MHz							
2437.00	58.76	PK	H	31.60	90.36	N/A	N/A
2437.00	48.93	AV	H	31.60	80.53	N/A	N/A
2437.00	74.39	PK	V	31.60	105.99	N/A	N/A
2437.00	64.35	AV	V	31.60	95.95	N/A	N/A
4874.00	37.94	PK	V	11.05	48.99	74.00	25.01
4874.00	23.46	AV	V	11.05	34.51	54.00	19.49
7311.00	33.51	PK	V	14.80	48.31	74.00	25.69
7311.00	21.30	AV	V	14.80	36.10	54.00	17.90
High Channel: 2452MHz							
2452.00	58.92	PK	H	31.63	90.55	N/A	N/A
2452.00	48.57	AV	H	31.63	80.20	N/A	N/A
2452.00	73.61	PK	V	31.63	105.24	N/A	N/A
2452.00	63.01	AV	V	31.63	94.64	N/A	N/A
2483.50	36.28	PK	V	31.64	67.92	74.00	6.08
2483.50	21.19	AV	V	31.64	52.83	54.00	1.17
4904.00	38.33	PK	V	11.14	49.47	74.00	24.53
4904.00	23.95	AV	V	11.14	35.09	54.00	18.91
7356.00	33.35	PK	V	14.80	48.15	74.00	25.85
7356.00	21.27	AV	V	14.80	36.07	54.00	17.93

BLE:

Frequency (MHz)	Receiver		Polar (H/V)	Factor (dB/m)	Result (dB μ V/m)	Limit (dB μ V/m)	Margin (dB)
	Reading (dB μ V)	Detector					
Low Channel: 2402 MHz							
2402.00	61.72	PK	H	31.51	93.23	N/A	N/A
2402.00	50.75	AV	H	31.51	82.26	N/A	N/A
2402.00	69.31	PK	V	31.51	100.82	N/A	N/A
2402.00	63.94	AV	V	31.51	95.45	N/A	N/A
2390.00	27.38	PK	V	31.46	58.84	74.00	15.16
2390.00	13.96	AV	V	31.46	45.42	54.00	8.58
4804.00	50.75	PK	V	10.91	61.66	74.00	12.34
4804.00	38.03	AV	V	10.91	48.94	54.00	5.06
7206.00	43.73	PK	V	14.22	57.95	74.00	16.05
7206.00	29.88	AV	V	14.22	44.10	54.00	9.90
Middle Channel: 2440 MHz							
2440.00	61.88	PK	H	31.60	93.48	N/A	N/A
2440.00	50.47	AV	H	31.60	82.07	N/A	N/A
2440.00	69.05	PK	V	31.60	100.65	N/A	N/A
2440.00	62.29	AV	V	31.60	93.89	N/A	N/A
4880.00	50.38	PK	V	11.07	61.45	74.00	12.55
4880.00	37.48	AV	V	11.07	50.55	54.00	5.45
7320.00	41.92	PK	V	14.80	56.72	74.00	17.28
7320.00	25.98	AV	V	14.80	40.78	54.00	13.22
High Channel: 2480 MHz							
2480.00	61.23	PK	H	31.64	92.87	N/A	N/A
2480.00	52.62	AV	H	31.64	84.26	N/A	N/A
2480.00	68.34	PK	V	31.64	99.98	N/A	N/A
2480.00	61.60	AV	V	31.64	93.24	N/A	N/A
2483.50	29.40	PK	V	31.64	61.04	74.00	12.96
2483.50	15.12	AV	V	31.64	46.76	54.00	7.24
4960.00	50.09	PK	V	11.23	61.32	74.00	12.68
4960.00	38.15	AV	V	11.23	49.38	54.00	4.62
7440.00	40.04	PK	V	15.26	55.30	74.00	18.70
7440.00	25.94	AV	V	15.26	41.20	54.00	12.80

Simultaneous Transmission:

Frequency (MHz)	Receiver		Polar (H/V)	Factor (dB/m)	Result (dB μ V/m)	Limit (dB μ V/m)	Margin (dB)
	Reading (dB μ V)	Detector					
Worst 802.11b High Channel+BLE High Channel+Lora DTS High+LTE Band 2 Middle Channel							
4924.00	42.69	PK	V	11.18	53.87	74.00	20.13
4924.00	36.44	AV	V	11.18	47.62	54.00	6.38
1855.00	59.14	PK	V	1.57	60.71	74.00	13.29
1855.00	37.45	AV	V	1.57	39.02	54.00	14.98
4960.00	51.02	PK	V	11.23	62.25	74.00	11.75
4960.00	37.44	AV	V	11.23	48.67	54.00	5.33

Worst Test plots(BLE high channel was the worst)

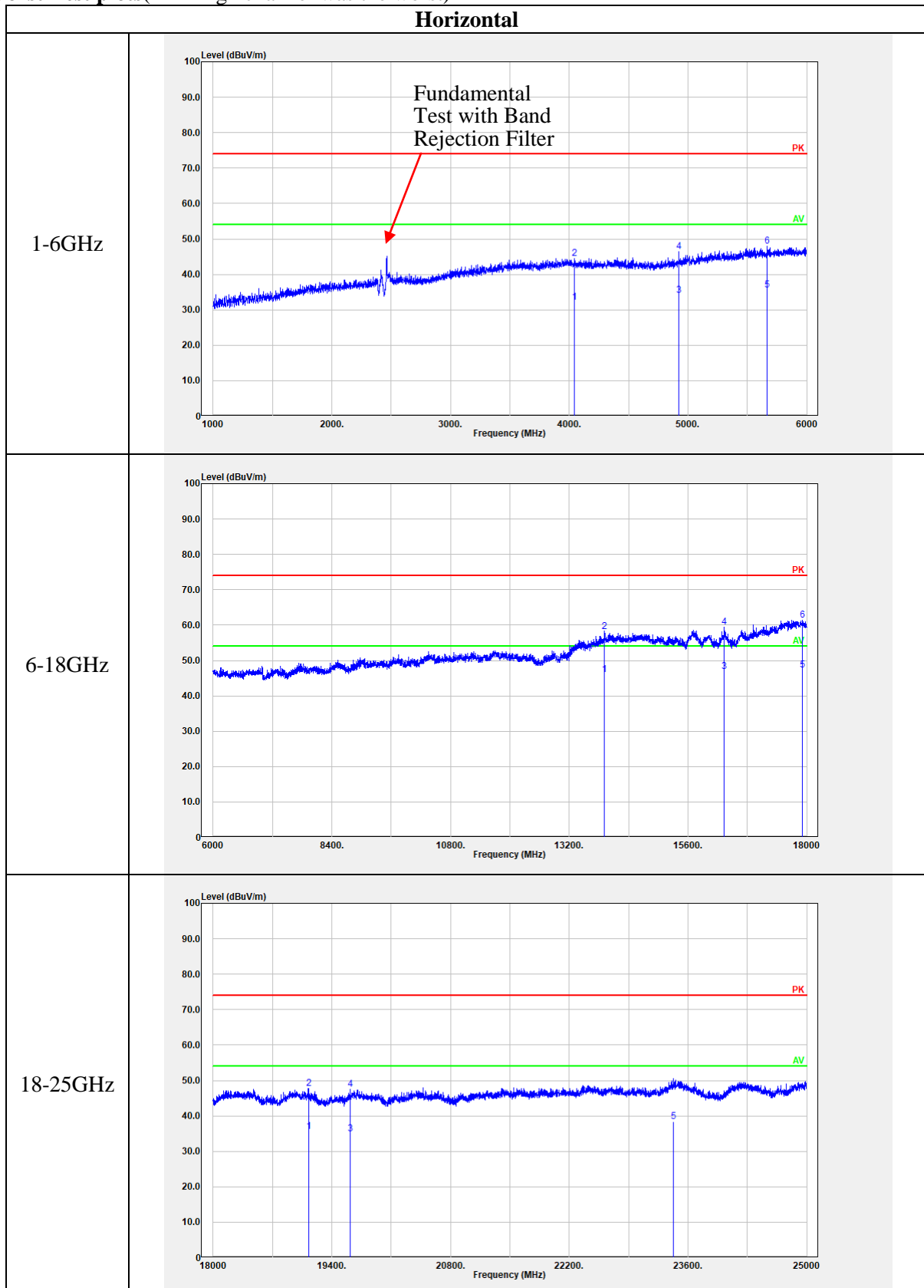

Vertical

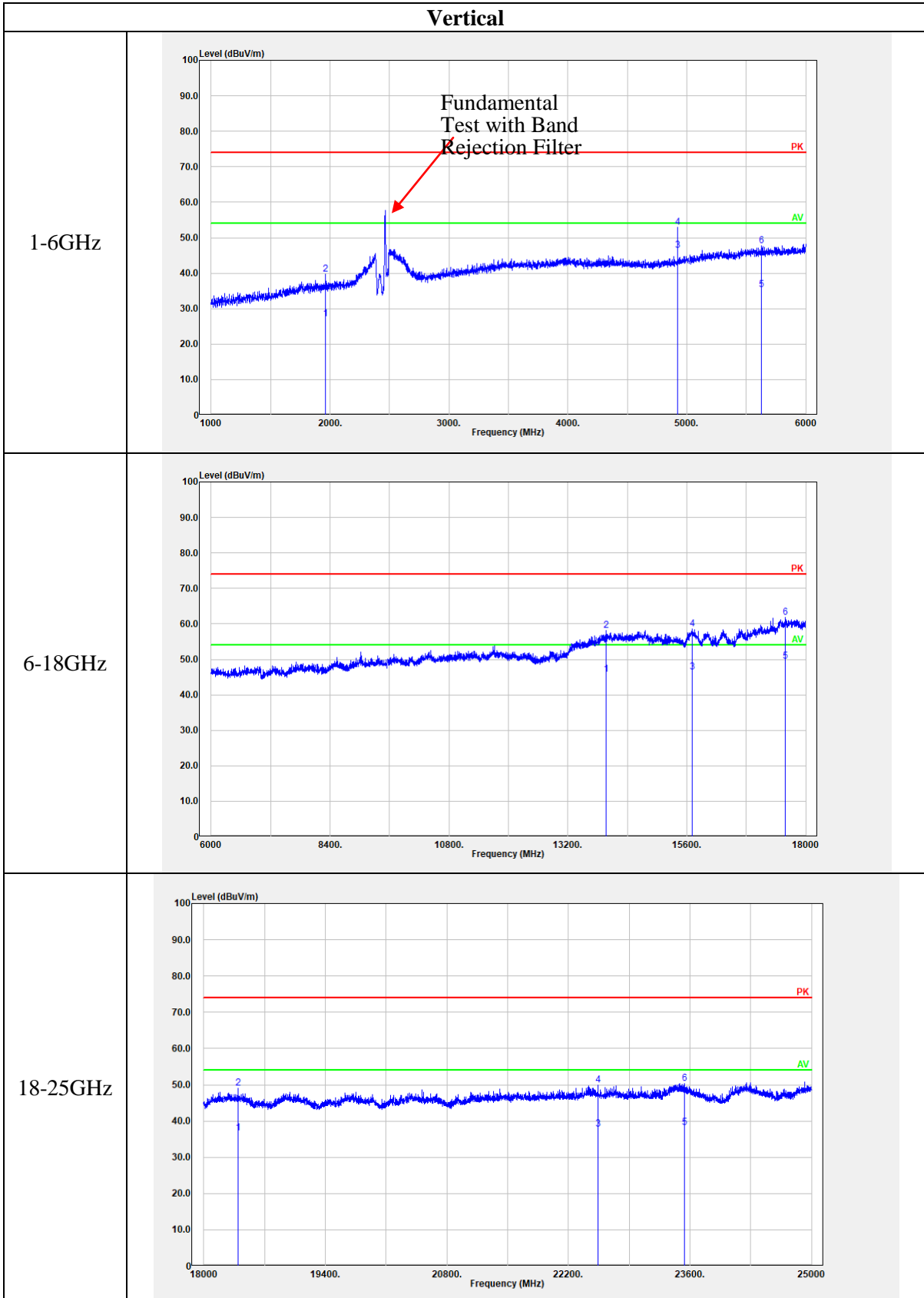

4.3 6 dB Emission Bandwidth:

Serial Number:	CR22040013-RF-S1	Test Date:	2022-04-24~2022-04-25
Test Site:	RF	Test Mode:	Transmitting
Tester:	Great Qiao	Test Result:	Pass

Environmental Conditions:

Temperature: (°C)	24.3~26.1	Relative Humidity: (%)	64~67	ATM Pressure: (kPa)	100.2~100.9
----------------------	-----------	------------------------------	-------	------------------------	-------------

Test Equipment List and Details:

Manufacturer	Description	Model	Serial Number	Calibration Date	Calibration Due Date
R&S	Signal Analyzer	FSIQ26	831929/006	2021-07-22	2022-07-21
zhuoxiang	Coaxial Cable	SMA-178	211001	Each time	N/A
Mini-Circuits	DC Block	BLK-18-S+	1554403	Each time	N/A
Weinschel	Coaxial Attenuators	53-20-34	LN751	Each time	N/A

* Statement of Traceability: China Certification ICT Co., Ltd (Dongguan) attests that all calibrations have been performed, traceable to National Primary Standards and International System of Units (SI).

Test Data:

Test Modes	Test Frequency (MHz)	6 dB Bandwidth (MHz)	Limit (MHz)
802.11b	2412	10.020	0.5
	2437	9.299	0.5
	2462	9.940	0.5
802.11g	2412	15.070	0.5
	2437	15.311	0.5
	2462	15.230	0.5
802.11n ht20	2412	15.150	0.5
	2437	15.311	0.5
	2462	15.311	0.5
802.11n ht40	2422	35.110	0.5
	2437	35.110	0.5
	2452	35.271	0.5
BLE	2402	1.427	0.5
	2440	1.435	0.5
	2480	1.427	0.5

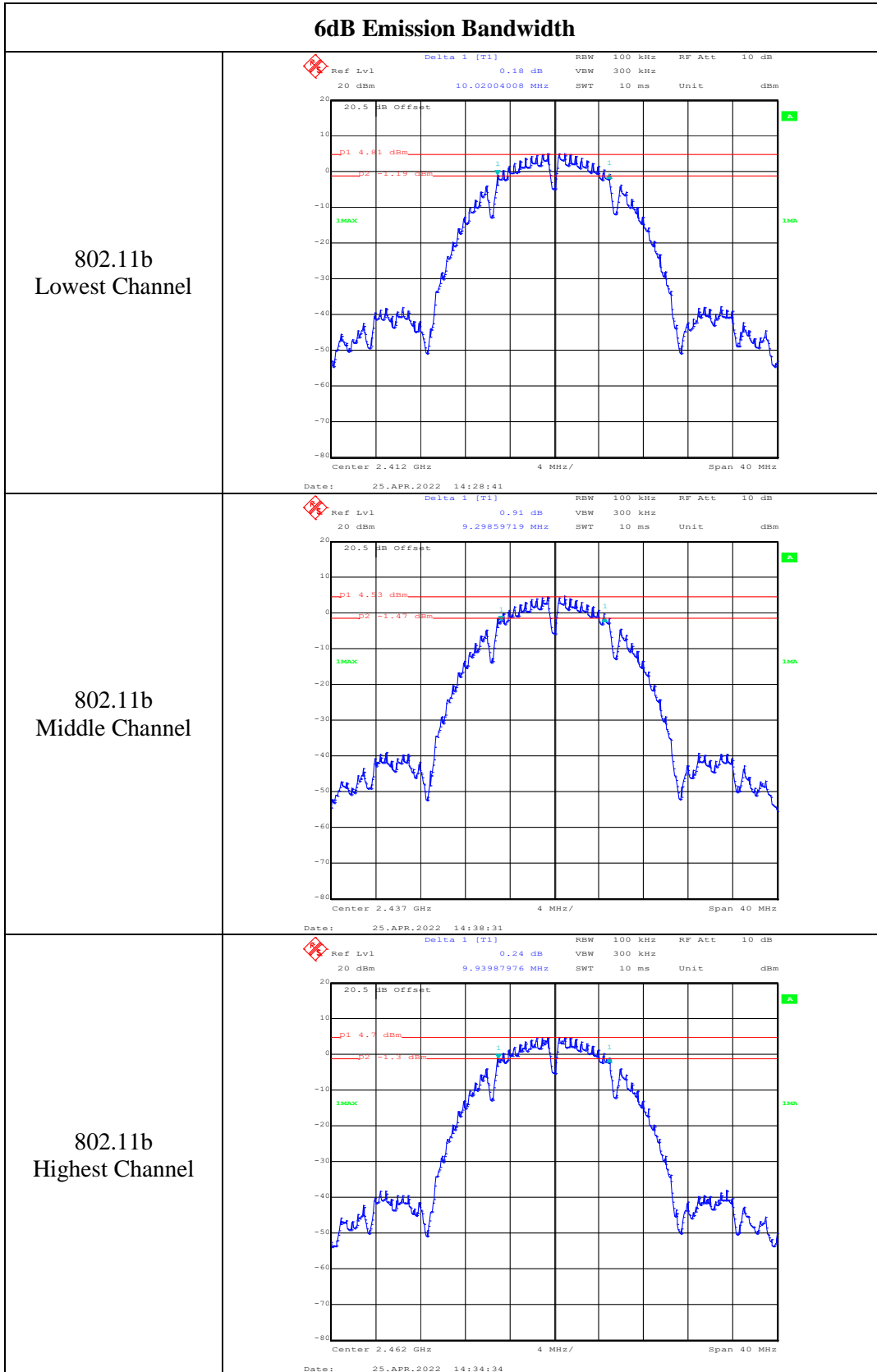

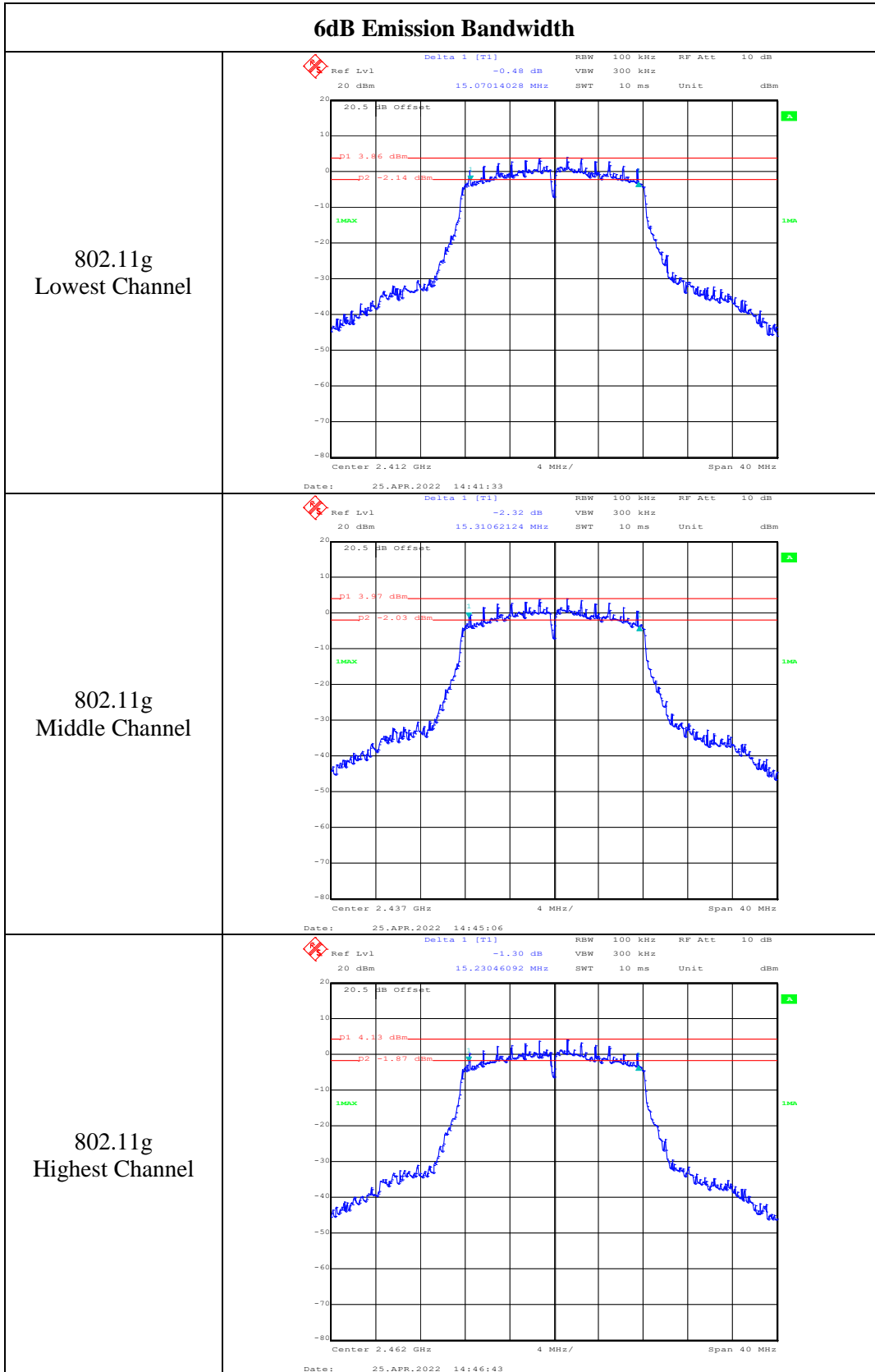

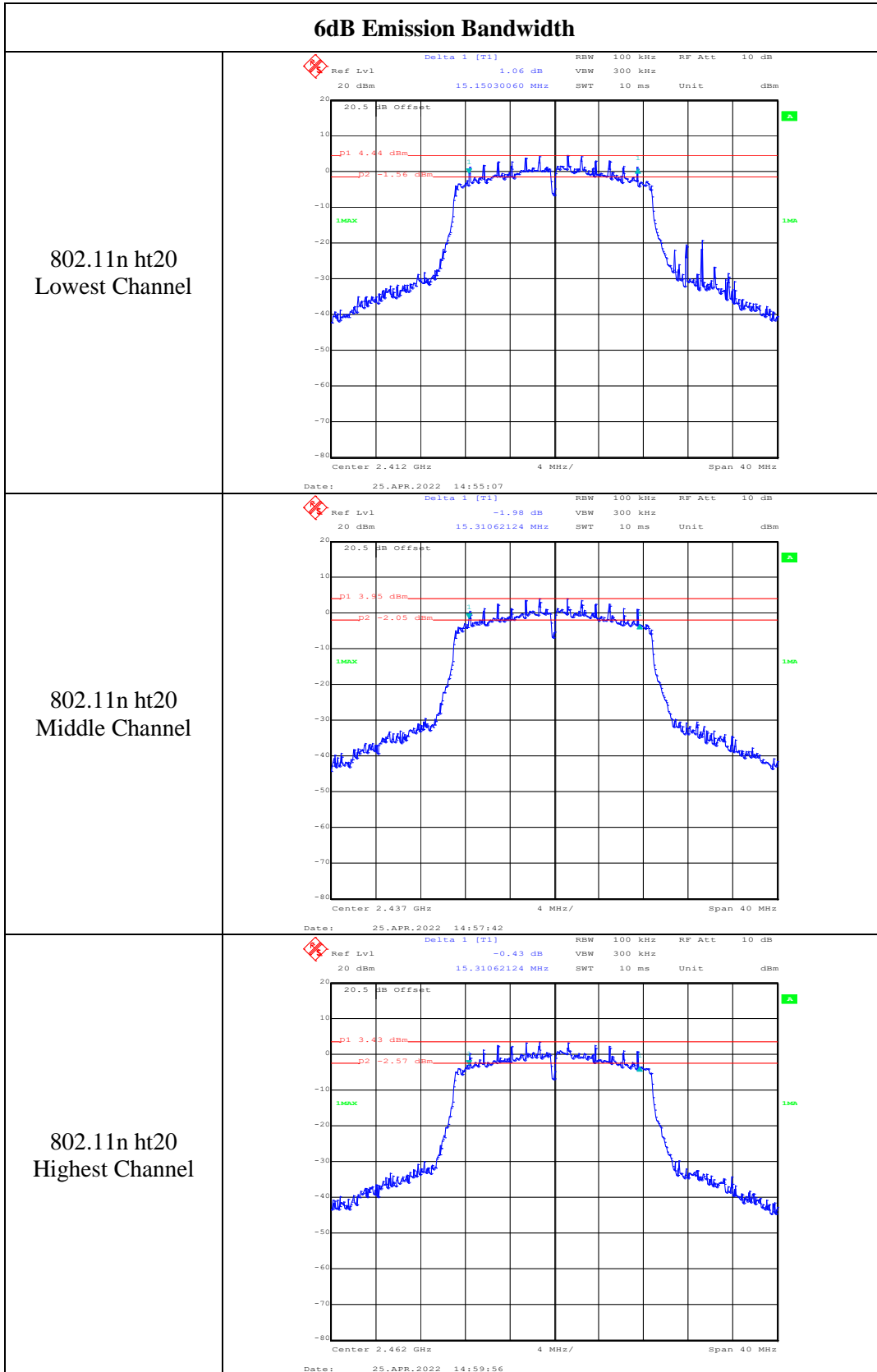

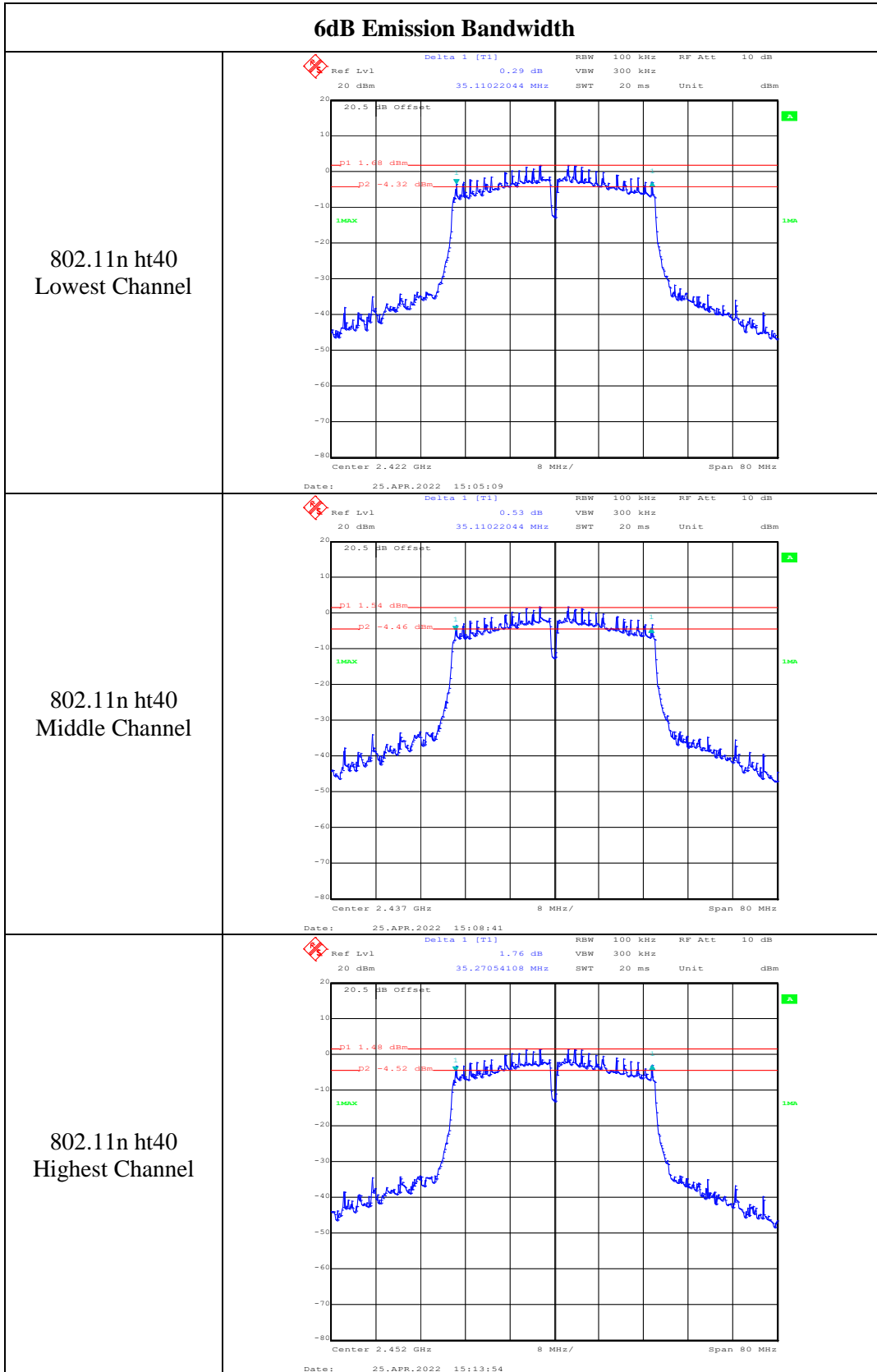

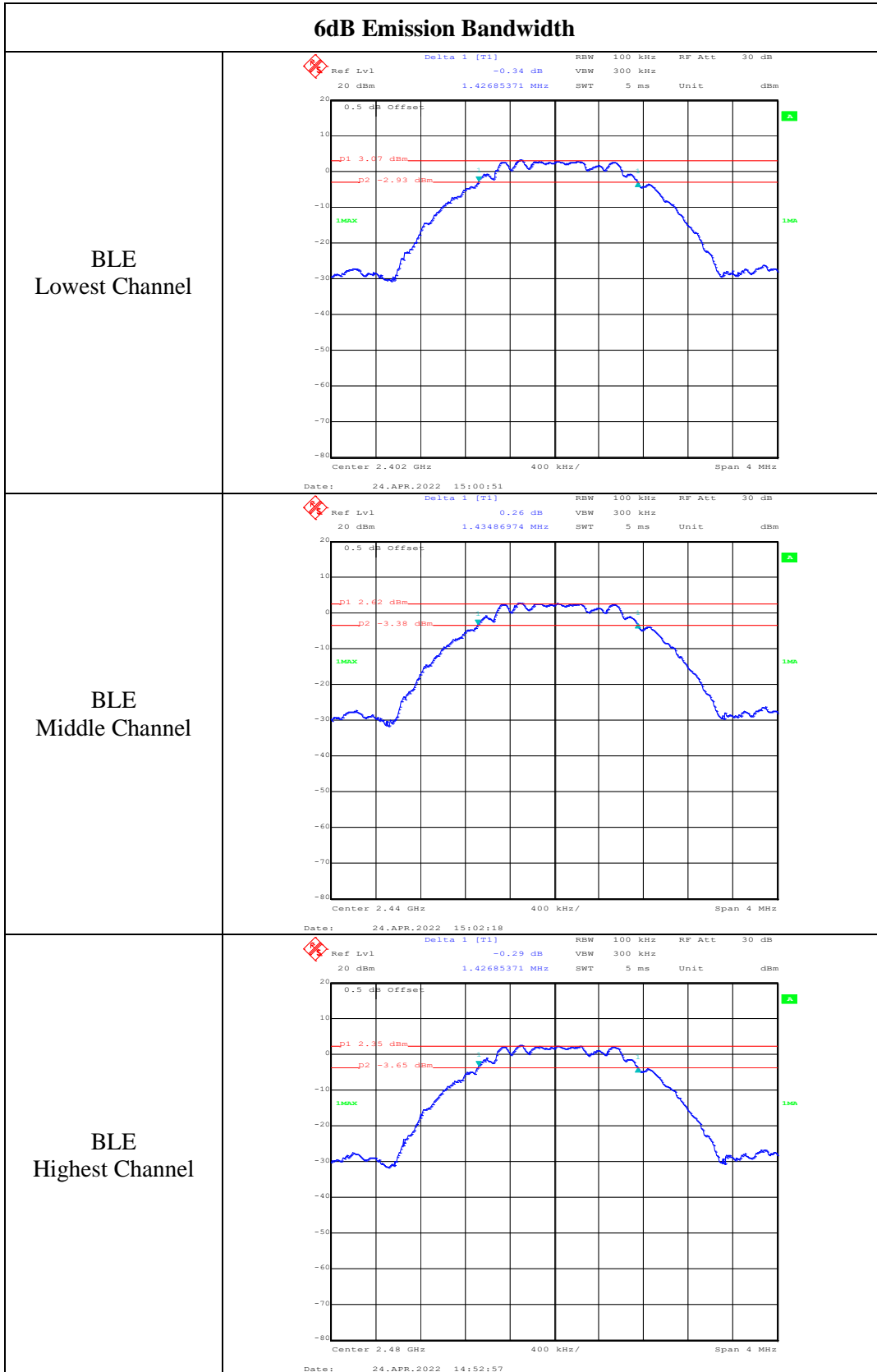

4.4 Maximum peak conducted output power:

Serial Number:	CR22040013-RF-S1	Test Date:	2022-04-24~2022-04-25
Test Site:	RF	Test Mode:	Transmitting
Tester:	Great Qiao	Test Result:	Pass

Environmental Conditions:

Temperature: (°C)	25.6~26.1	Relative Humidity: (%)	63~67	ATM Pressure: (kPa)	100.2~100.9
----------------------	-----------	------------------------------	-------	------------------------	-------------

Test Equipment List and Details:

Manufacturer	Description	Model	Serial Number	Calibration Date	Calibration Due Date
Unknown	Coaxial Cable	C-SJ00-0010	C0010/01	Each time	N/A
Agilent	USB Wideband Power Sensor	U2021XA	MY54080015	2021-07-22	2022-07-21
Weinschel	Coaxial Attenuators	53-20-34	LN751	Each time	N/A
Mini-Circuits	DC Block	BLK-18-S+	1554403	Each time	N/A

* Statement of Traceability: China Certification ICT Co., Ltd (Dongguan) attests that all calibrations have been performed, traceable to National Primary Standards and International System of Units (SI).

Test Data:

Test Modes	Test Channel	Test Frequency (MHz)	Maximum Conducted Peak Output Power (dBm)	Limit (dBm)
802.11b	Lowest	2412	15.15	30
	Middle	2437	14.86	30
	Highest	2462	15.62	30
802.11g	Lowest	2412	22.06	30
	Middle	2437	21.77	30
	Highest	2462	22.46	30
802.11n ht20	Lowest	2412	22.29	30
	Middle	2437	22.26	30
	Highest	2462	22.41	30
802.11n ht40	Lowest	2422	21.44	30
	Middle	2437	21.84	30
	Highest	2452	22.26	30
BLE	Lowest	2402	5.71	30
	Middle	2440	5.43	30
	Highest	2480	5.33	30

4.5 Maximum power spectral density:

Serial Number:	CR22040013-RF-S1	Test Date:	2022-04-24~2022-04-25
Test Site:	RF	Test Mode:	Transmitting
Tester:	Great Qiao	Test Result:	Pass

Environmental Conditions:

Temperature: (°C)	25.6~26.1	Relative Humidity: (%)	58~67	ATM Pressure: (kPa)	100.2~100.9
----------------------	-----------	---------------------------	-------	------------------------	-------------

Test Equipment List and Details:

Manufacturer	Description	Model	Serial Number	Calibration Date	Calibration Due Date
R&S	Signal Analyzer	FSIQ26	831929/006	2021-07-22	2022-07-21
zhuoxiang	Coaxial Cable	SMA-178	211001	Each time	N/A
Mini-Circuits	DC Block	BLK-18-S+	1554403	Each time	N/A
Weinschel	Coaxial Attenuators	53-20-34	LN751	Each time	N/A

* Statement of Traceability: China Certification ICT Co., Ltd (Dongguan) attests that all calibrations have been performed, traceable to National Primary Standards and International System of Units (SI).

Test Data:

Test Channel	Test Frequency (MHz)	Power Spectral Density (dBm/3kHz)	Limit (dBm/3kHz)
802.11b	2412	3.46	8.00
	2437	2.85	8.00
	2462	-1.34	8.00
802.11g	2412	-11.15	8.00
	2437	-12.26	8.00
	2462	-12.51	8.00
802.11n ht20	2412	-12.01	8.00
	2437	-11.2	8.00
	2462	-11.6	8.00
802.11n ht40	2422	-13.47	8.00
	2437	-14.42	8.00
	2452	-14.05	8.00
BLE	2402	-15.19	8.00
	2440	-15.4	8.00
	2480	-15.67	8.00

Maximum power spectral density

<p>802.11b Lowest Channel</p>	<p>Marker 1 [T1] Ref Lvl 3.46 dBm 20 dBm 2.41114157 GHz RBW 3 kHz VBW 10 kHz RF Att 10 dB SWT 4.2 s Unit dBm</p> <p>Center 2.412 GHz 15.03 MHz/ Span 15.03 MHz Date: 25.APR.2022 14:29:54</p>
<p>802.11b Middle Channel</p>	<p>Marker 1 [T1] Ref Lvl 2.85 dBm 20 dBm 2.43765689 GHz RBW 3 kHz VBW 10 kHz RF Att 10 dB SWT 3.9 s Unit dBm</p> <p>Center 2.437 GHz 13.9485 MHz/ Span 13.9485 MHz Date: 25.APR.2022 14:39:39</p>
<p>802.11b Highest Channel</p>	<p>Marker 1 [T1] Ref Lvl -1.34 dBm 20 dBm 2.46165638 GHz RBW 3 kHz VBW 10 kHz RF Att 10 dB SWT 4.2 s Unit dBm</p> <p>Center 2.462 GHz 14.91 MHz/ Span 14.91 MHz Date: 25.APR.2022 14:35:47</p>

Maximum power spectral density

<p>802.11g Lowest Channel</p>	
<p>802.11g Middle Channel</p>	
<p>802.11g Highest Channel</p>	

Maximum power spectral density

<p>802.11n ht20 Lowest Channel</p>	<p>Marker 1 [T1] RBW 3 kHz RF Att 10 dB Ref Lvl -12.01 dBm VBW 10 kHz 20 dBm 2.41092978 GHz SWT 6.4 s Unit dBm</p> <p>Center 2.412 GHz 2.2725 MHz/ Span 22.725 MHz</p> <p>Date: 25.APR.2022 14:56:08</p>
<p>802.11n ht20 Middle Channel</p>	<p>Marker 1 [T1] RBW 3 kHz RF Att 10 dB Ref Lvl -11.20 dBm VBW 10 kHz 20 dBm 2.43564226 GHz SWT 6.4 s Unit dBm</p> <p>Center 2.437 GHz 2.29665 MHz/ Span 22.9665 MHz</p> <p>Date: 25.APR.2022 14:59:06</p>
<p>802.11n ht20 Highest Channel</p>	<p>Marker 1 [T1] RBW 3 kHz RF Att 10 dB Ref Lvl -11.60 dBm VBW 10 kHz 20 dBm 2.45939958 GHz SWT 6.4 s Unit dBm</p> <p>Center 2.462 GHz 2.29665 MHz/ Span 22.9665 MHz</p> <p>Date: 25.APR.2022 15:00:57</p>

Maximum power spectral density

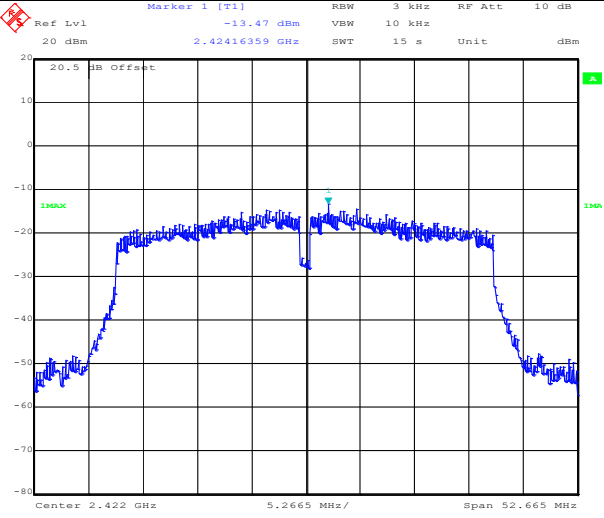
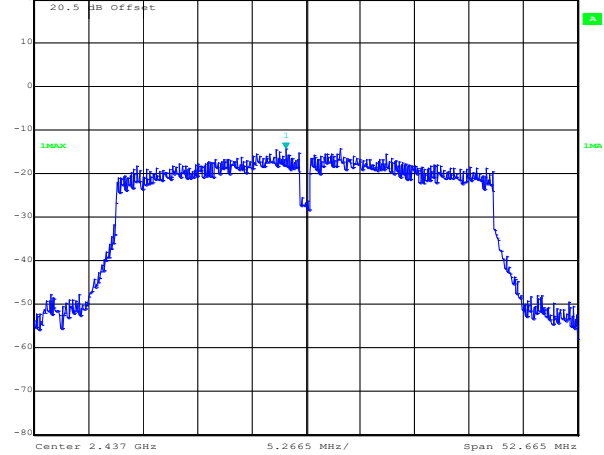
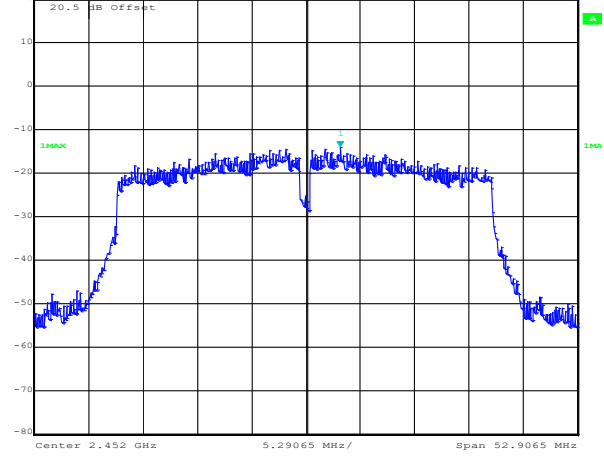
<p>802.11n ht40 Lowest Channel</p>	 <p>Marker 1 [T1] RBW 3 kHz RF Att 10 dB Ref Lvl -13.47 dBm VBW 10 kHz 20 dBm 2.42416359 GHz SWT 15 s Unit dBm</p> <p>Center 2.422 GHz 5.2665 MHz/ Span 52.665 MHz</p> <p>Date: 25.APR.2022 15:07:07</p>
<p>802.11n ht40 Middle Channel</p>	 <p>Marker 1 [T1] RBW 3 kHz RF Att 10 dB Ref Lvl -14.42 dBm VBW 10 kHz 20 dBm 2.43504749 GHz SWT 15 s Unit dBm</p> <p>Center 2.437 GHz 5.2665 MHz/ Span 52.665 MHz</p> <p>Date: 25.APR.2022 15:10:40</p>
<p>802.11n ht40 Highest Channel</p>	 <p>Marker 1 [T1] RBW 3 kHz RF Att 10 dB Ref Lvl -14.05 dBm VBW 10 kHz 20 dBm 2.45533979 GHz SWT 15 s Unit dBm</p> <p>Center 2.452 GHz 5.29065 MHz/ Span 52.9065 MHz</p> <p>Date: 25.APR.2022 15:15:54</p>

Maximum power spectral density

<p>BLE Lowest Channel</p>	
<p>BLE Middle Channel</p>	
<p>BLE Highest Channel</p>	

4.6 100 kHz Bandwidth of Frequency Band Edge:

Serial Number:	CR22040013-RF-S1	Test Date:	2022-04-24~2022-04-25
Test Site:	RF	Test Mode:	Transmitting
Tester:	Great Qiao	Test Result:	Pass

Environmental Conditions:					
Temperature: (°C)	25.6~26.1	Relative Humidity: (%)	66~67	ATM Pressure: (kPa)	100.2~100.9

Test Equipment List and Details:

Manufacturer	Description	Model	Serial Number	Calibration Date	Calibration Due Date
R&S	Signal Analyzer	FSIQ26	831929/006	2021-07-22	2022-07-21
zhuoxiang	Coaxial Cable	SMA-178	211001	Each time	N/A
Mini-Circuits	DC Block	BLK-18-S+	1554403	Each time	N/A
Weinschel	Coaxial Attenuators	53-20-34	LN751	Each time	N/A

* Statement of Traceability: China Certification ICT Co., Ltd (Dongguan) attests that all calibrations have been performed, traceable to National Primary Standards and International System of Units (SI).

100 kHz Bandwidth of Frequency Band Edge

802.11b
Lowest Band edge

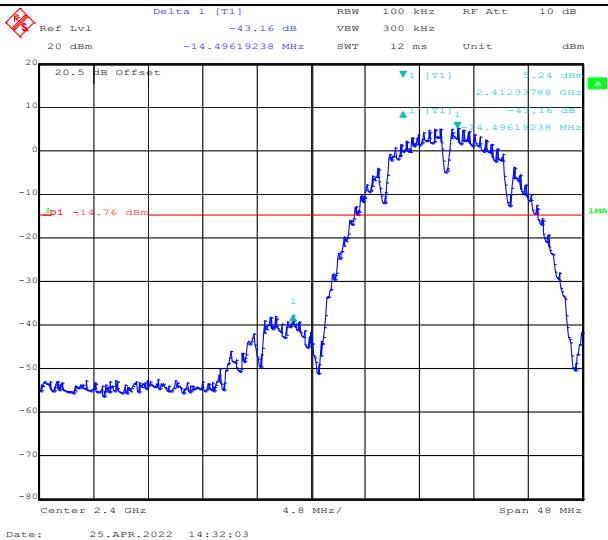

802.11b
Highest Band edge

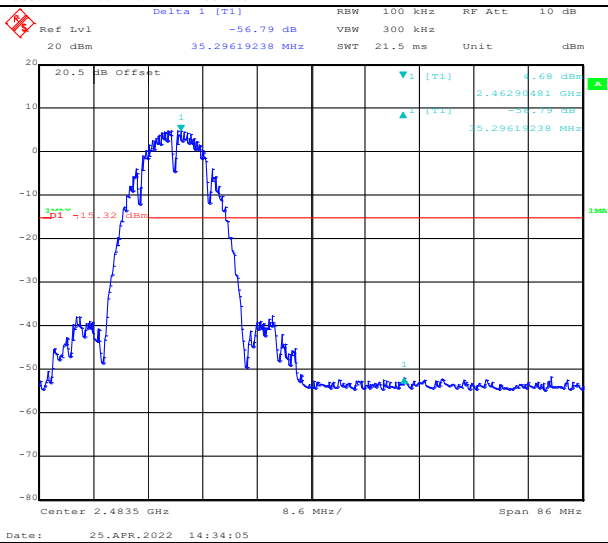

100 kHz Bandwidth of Frequency Band Edge

802.11g
Lowest Band edge

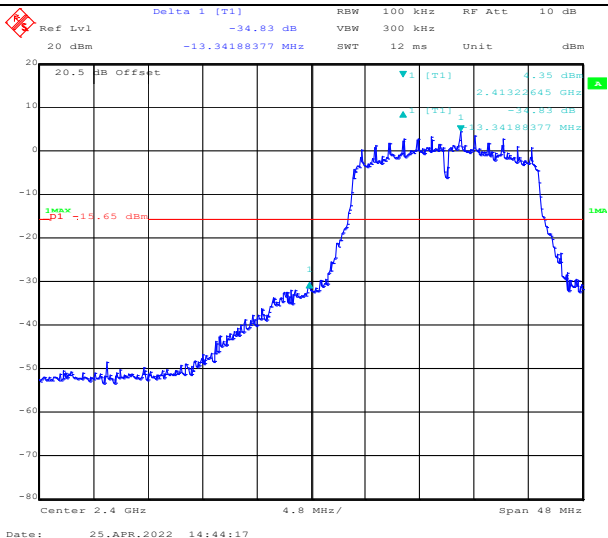

802.11g
Highest Band edge

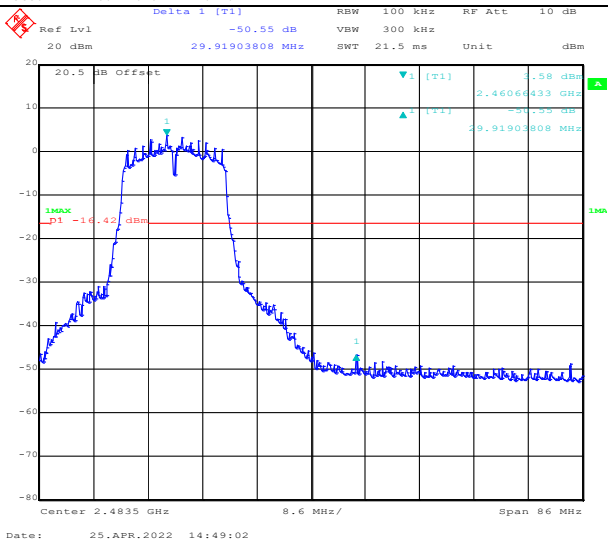

100 kHz Bandwidth of Frequency Band Edge

802.11n ht20
Lowest Band edge

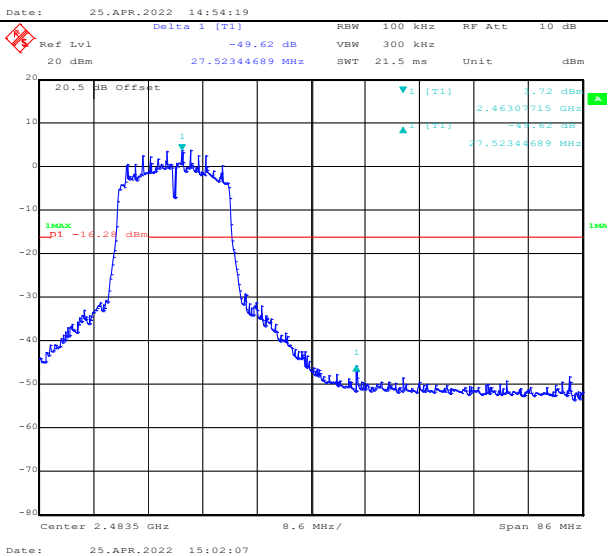
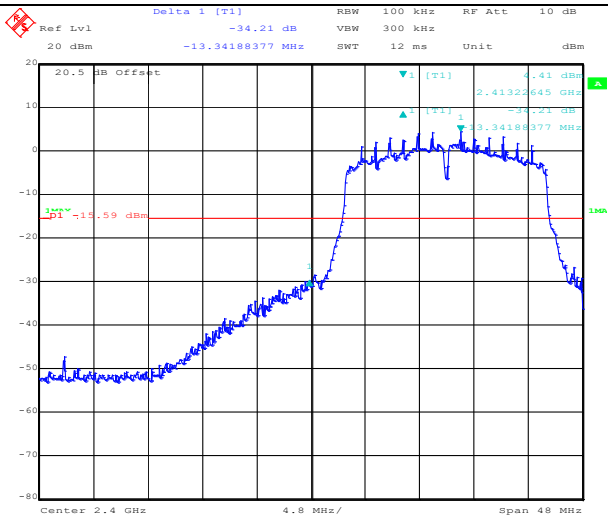

802.11n ht20
Highest Band edge

100 kHz Bandwidth of Frequency Band Edge

802.11n ht40
Lowest Band edge

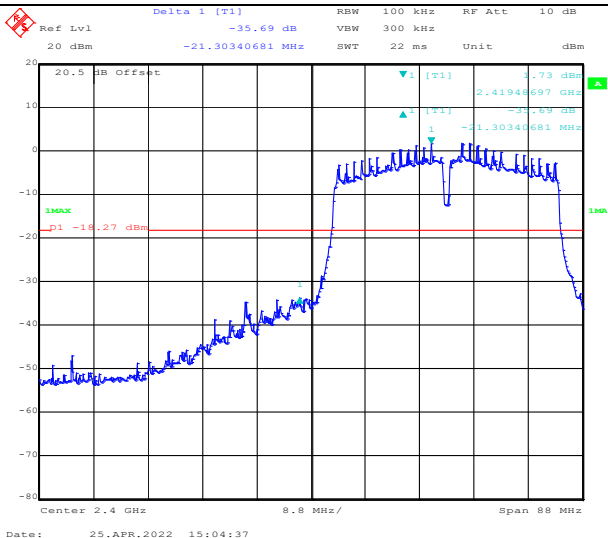

802.11n ht40
Highest Band edge

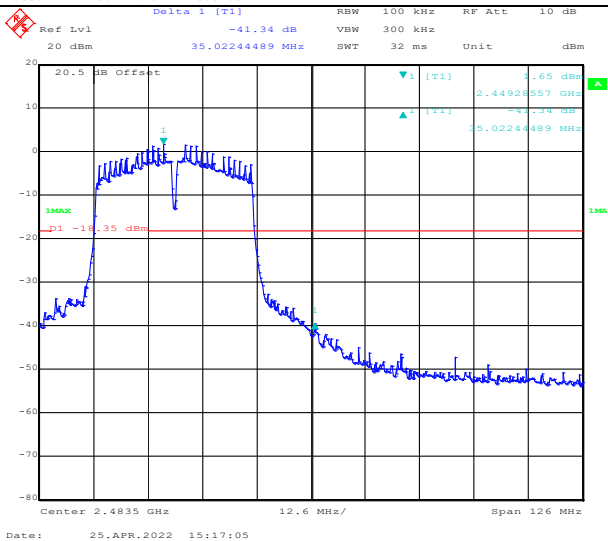

100 kHz Bandwidth of Frequency Band Edge

BLE
Lowest Band edge

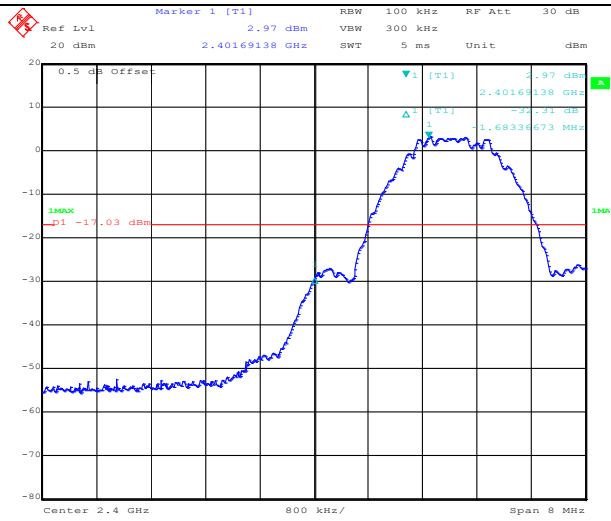

BLE
Highest Band edge

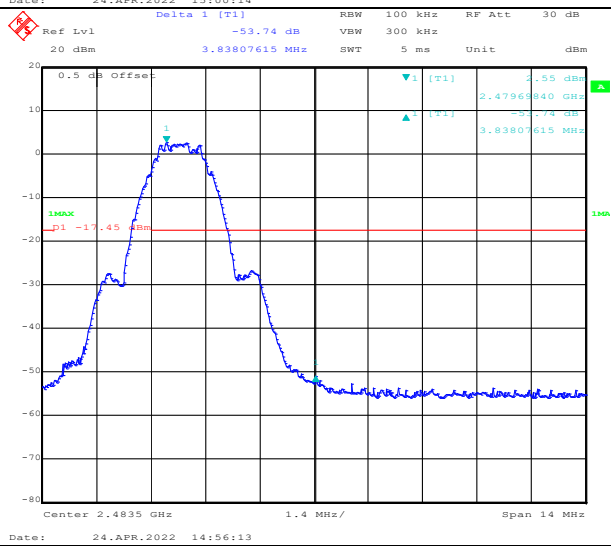

4.7 Duty Cycle:

Serial Number:	CR22040013-RF-S1	Test Date:	2022-04-24~2022-04-25
Test Site:	RF	Test Mode:	Transmitting
Tester:	Great Qiao	Test Result:	Pass

Environmental Conditions:

Temperature: (°C)	24.3~26.1	Relative Humidity: (%)	64~67	ATM Pressure: (kPa)	100.2~100.9
----------------------	-----------	------------------------------	-------	------------------------	-------------

Test Equipment List and Details:

Manufacturer	Description	Model	Serial Number	Calibration Date	Calibration Due Date
R&S	Signal Analyzer	FSIQ26	831929/006	2021-07-22	2022-07-21
zhuoxiang	Coaxial Cable	SMA-178	211001	Each time	N/A
Mini-Circuits	DC Block	BLK-18-S+	1554403	Each time	N/A
Weinschel	Coaxial Attenuators	53-20-34	LN751	Each time	N/A

* Statement of Traceability: China Certification ICT Co., Ltd (Dongguan) attests that all calibrations have been performed, traceable to National Primary Standards and International System of Units (SI).

Test Data:

Test Modes	Ton (ms)	Ton+off (ms)	Duty cycle (%)
802.11b	100	100	100.00
802.11g	1.419	1.455	97.53
802.11n ht20	1.321	1.376	96.00
802.11n ht40	0.651	0.695	93.67
BLE	100	100	100.00

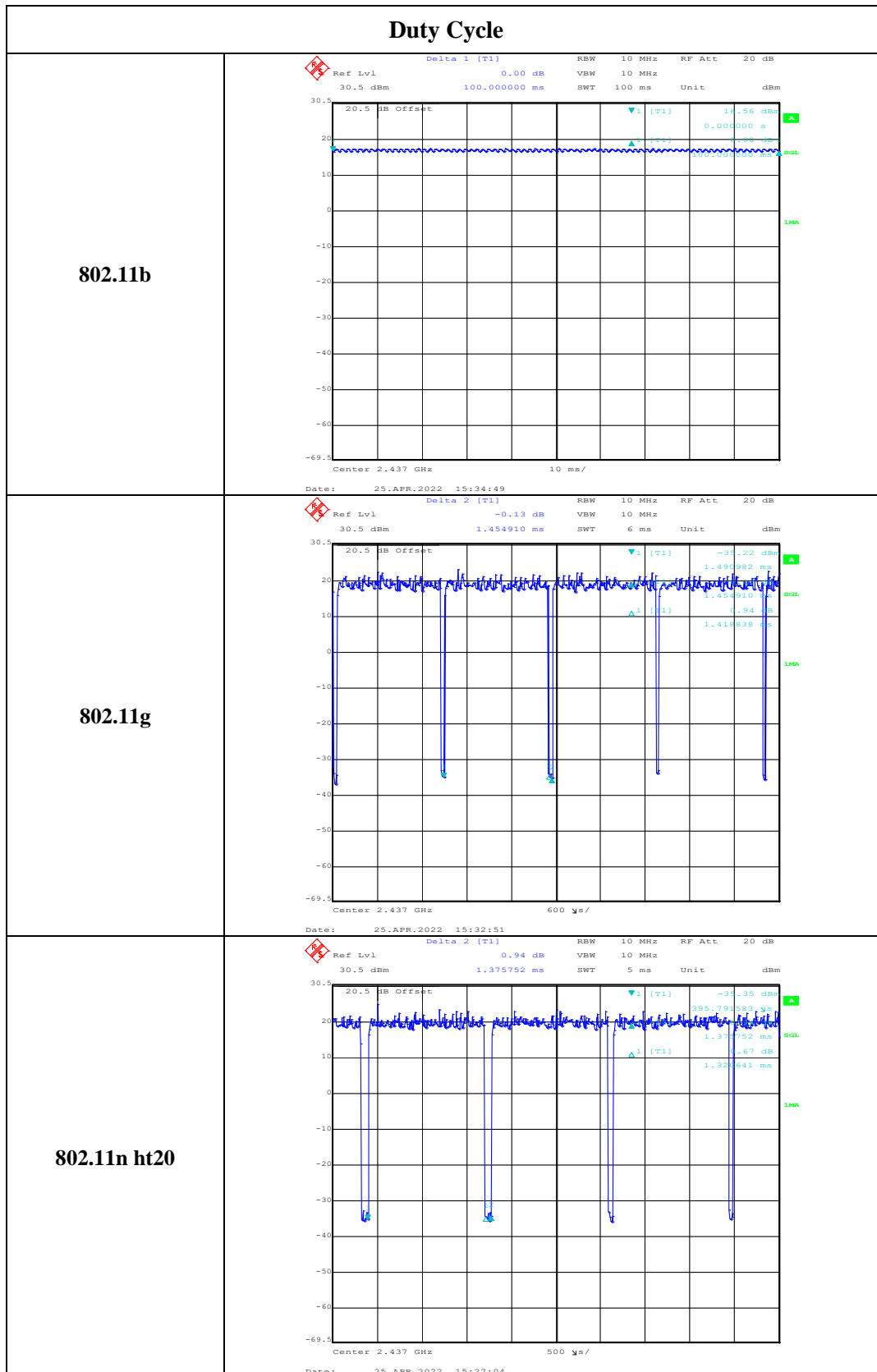

802.11n ht40

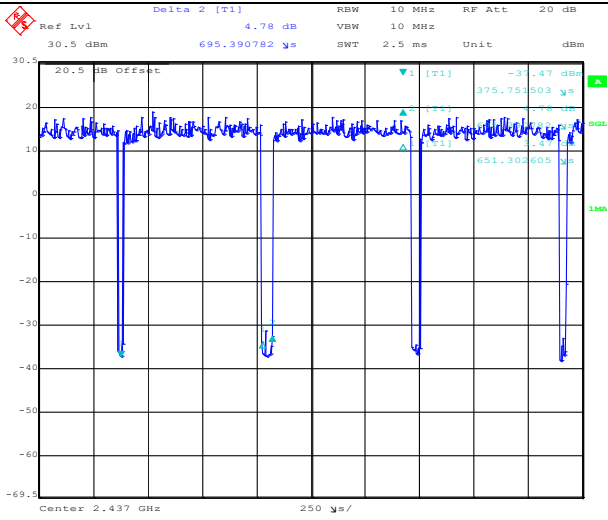

BLE

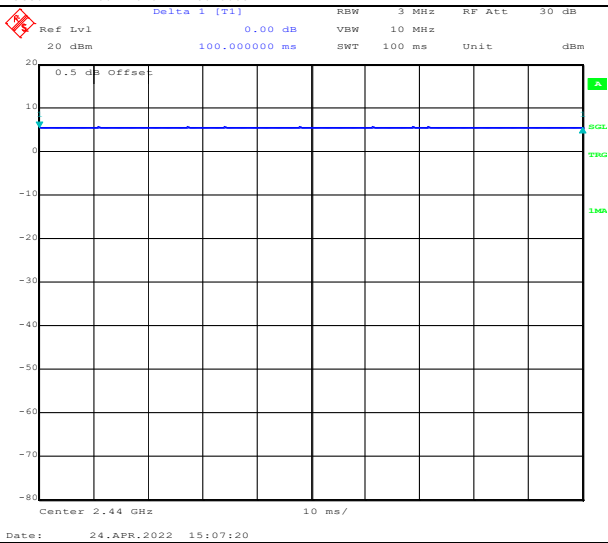

5. RF EXPOSURE EVALUATION

5.1 MAXIMUM PERMISSIBLE EXPOSURE (MPE)

5.1.1 Applicable Standard

FCC §15.247 (i) & §1.1310 & §2.1091

Systems operating under the provisions of this section shall be operated in a manner that ensures that the public is not exposed to radio frequency energy levels in excess of the Commission's guidelines. See §1.1307(b)(1) of this chapter.

Limits for Maximum Permissible Exposure (MPE) (§1.1310, §2.1091)

(B) Limits for General Population/Uncontrolled Exposure				
Frequency Range (MHz)	Electric Field Strength (V/m)	Magnetic Field Strength (A/m)	Power Density (mW/cm ²)	Averaging Time (minutes)
0.3–1.34	614	1.63	*(100)	30
1.34–30	824/f	2.19/f	*(180/f ²)	30
30–300	27.5	0.073	0.2	30
300–1500	/	/	f/1500	30
1500–100,000	/	/	1.0	30

f = frequency in MHz; * = Plane-wave equivalent power density;

According to §1.1310 and §2.1091 RF exposure is calculated.

5.1.2 Procedure

Prediction of power density at the distance of the applicable MPE limit

$S = PG/4\pi R^2$ = power density (in appropriate units, e.g. mW/cm²);

P = power input to the antenna (in appropriate units, e.g., mW);

G = power gain of the antenna in the direction of interest relative to an isotropic radiator, the power gain factor, is normally numeric gain;

R = distance to the center of radiation of the antenna (appropriate units, e.g., cm);

For simultaneously transmit system, the calculated power density should comply with:

$$\sum_i \frac{S_i}{S_{Limit,i}} \leq 1$$

Calculated Data:

Radio	Frequency (MHz)	Antenna Gain		Conducted output power including Tune-up Tolerance		Evaluation Distance (cm)	Power Density (mW/cm ²)	MPE Limit (mW/cm ²)
		(dBi)	(numeric)	(dBm)	(mW)			
Lora-DSS	902.3-914.9	2	1.58	18	63.10	20.00	0.02	0.60
Lora-DTS	923.3-927.5	2	1.58	27	501.19	20.00	0.16	0.60
BLE	2402-2480	2	1.58	6	3.98	20.00	0.001	1.0
WLAN	2412-2462	4	2.51	23	199.53	20.00	0.1	1.0
WCDMA B2	1850-1910	3	2.00	25	316.23	20.00	0.13	1.0
WCDMA B4	1710-1755	3	2.00	25	316.23	20.00	0.13	1.0
WCDMA B5	824-849	3	2.00	25	316.23	20.00	0.13	0.55
LTE B2	1850-1910	3	2.00	25	316.23	20.00	0.13	1.0
LTE B4	1710-1755	3	2.00	25	316.23	20.00	0.13	1.0
LTE B5	824-849	3	2.00	25	316.23	20.00	0.13	0.55
LTE B12	699-716	3	2.00	25	316.23	20.00	0.13	0.47
LTE B13	777-787	3	2.00	25	316.23	20.00	0.13	0.52
LTE B14	788-798	3	2.00	25	316.23	20.00	0.13	0.53
LTE B66	1710-1780	3	2.00	25	316.23	20.00	0.13	1.0
LTE B71	663-698	3	2.00	25	316.23	20.00	0.13	0.44

The devices may contain certified WWAN Module, FCC ID: XMR202008EC25AFXD.
The WLAN 2.4G/BLE/Lora/WWAN can transmit simultaneously:

$$\sum_i \frac{S_i}{S_{Limit,i}}$$

$$=S_{WLAN}/S_{limit-WLAN} + S_{Lora}/S_{limit-Lora} + S_{BLE}/S_{limit-BLE} + S_{WWAN}/S_{limit-WWAN}$$

$$=0.10/1+0.16/0.60+0.001/1+0.13/0.44$$

$$=0.66$$

$$< 1.0$$

Result: The device meet FCC MPE at 20 cm distance

===== END OF REPORT =====