



No. 24T04Z100676-004



HAC T-Coil TEST REPORT

No. 24T04Z100676-004

For

COOSEA GROUP (HK) COMPANY LIMITED

Smart Phone

Model Name: SN509A/SN509C

with

Hardware Version: 1.0

Software Version: WFA131051 / WFA131052

FCC ID: 2A28USN509

HAC-2019 Compliance: PASS

Issued Date: 2024-07-04

Note:

The test results in this test report relate only to the devices specified in this report. This report shall not be reproduced except in full without the written approval of CTTL.

Test Laboratory:

CTTL, Telecommunication Technology Labs, CAICT

No. 52, Huayuan North Road, Haidian District, Beijing, P. R. China 100191.

Tel:+86(0)10-62304633-2512, Fax:+86(0)10-62304633-2504

Email: cttl_terminals@caict.ac.cn, website: www.caict.ac.cn



REPORT HISTORY

Report Number	Revision	Issue Date	Description
24T04Z100676-004	Rev.0	2024-06-06	Initial creation of test report
24T04Z100676-004	Rev.1	2024-07-04	Update instruments list in section14 on page35

TABLE OF CONTENT

1 TEST LABORATORY	5
1.1 INTRODUCTION & ACCREDITATION	5
1.2 TESTING LOCATION	5
1.3 TESTING ENVIRONMENT	6
1.4 PROJECT DATA	6
1.5 SIGNATURE	6
2 CLIENT INFORMATION	7
2.1 APPLICANT INFORMATION	7
2.2 MANUFACTURER INFORMATION	7
3 EQUIPMENT UNDER TEST (EUT) AND ANCILLARY EQUIPMENT (AE)	8
3.1 ABOUT EUT	8
3.2 INTERNAL IDENTIFICATION OF EUT USED DURING THE TEST	8
3.3 INTERNAL IDENTIFICATION OF AE USED DURING THE TEST	8
3.4 AIR INTERFACES / BANDS INDICATING OPERATING MODES.....	9
4 REFERENCE DOCUMENTS	9
5 OPERATIONAL CONDITIONS DURING TEST	10
5.1 HAC MEASUREMENT SET-UP.....	10
5.2 AM1D PROBE	11
5.3 AMCC	11
5.4 AMMI.....	12
5.5 TEST ARCH PHANTOM &PHONE POSITIONER.....	12
5.6 ROBOTIC SYSTEM SPECIFICATIONS	13
5.7 T-COIL MEASUREMENT POINTS AND REFERENCE PLANE	13
6 T-COIL TEST PROCEDURES	15
7 T-COIL PERFORMANCE REQUIREMENTS	17
7.1 T-COIL COUPLING QUALIFYING FIELD STRENGTHS.....	17
7.2 FREQUENCY RESPONSE.....	17
7.3 DESIRED ABM SIGNAL, UNDESIRED ABM FIELD QUALIFICATION REQUIREMENTS	18
8 3G VOICE DUT CONFIGURATION	19
8.1 UMTS CODEC INVESTIGATION.....	19
9 VOLTE TEST SYSTEM SETUP AND DUT CONFIGURATION	20
9.1 TEST SYSTEM SETUP FOR VOLTE OVER IMS T-COIL TESTING.....	20
9.2 CODEC CONFIGURATION.....	21
9.3 RADIO CONFIGURATION	21
10 VOWIFI TEST SYSTEM SETUP AND DUT CONFIGURATION	23
10.1 TEST SYSTEM SETUP FOR VoWiFi OVER IMS T-COIL TESTING.....	23
10.2 CODEC CONFIGURATION.....	24
10.3 RADIO CONFIGURATION.....	25
11 OTT VOIP TEST SYSTEM AND DUT CONFIGURATION	26
11.1 TEST SYSTEM SETUP FOR OTT VOIP T-COIL TESTING	26
11.2 CODEC CONFIGURATION.....	27
12 HAC T-COIL TEST DATA SUMMARY	29
12.1 TEST RESULTS FOR 3G	29
12.2 TEST RESULTS FOR VOLTE	29
12.3 TEST RESULTS FOR VOLTE WITH NSA.....	29
12.4 TEST RESULTS FOR VoWiFi	30
12.5 TEST RESULTS FOR OTT VOIP	31
12.6 TOTAL MEASUREMENT CONCLUSION	33



13 MEASUREMENT UNCERTAINTY34

14 MAIN TEST INSTRUMENTS35

ANNEX A TEST LAYOUT36

ANNEX B TEST PLOTS37

ANNEX C FREQUENCY REPOSE CURVES.....39

ANNEX D PROBE CALIBRATION CERTIFICATE40

ANNEX E DAE CALIBRATION CERTIFICATE43



No. 24T04Z100676-004

1 Test Laboratory

1.1 Introduction & Accreditation

Telecommunication Technology Labs, CAICT is an ISO/IEC 17025:2017 accredited test laboratory under American Association for Laboratory Accreditation (A2LA) with lab code 7049.01, and is also an FCC accredited test laboratory (CN1349), and ISED accredited test laboratory (CAB identifier:CN0066). The detail accreditation scope can be found on A2LA website.

1.2 Testing Location

Company Name:	CTTL
Address:	No. 52, Huayuan North Road, Haidian District, Beijing, P. R. China 100191.

1.3 Testing Environment

Temperature:	18°C~25°C,
Relative humidity:	30%~ 70%
Ground system resistance:	< 0.5 Ω
Ambient noise is checked and found very low and in compliance with requirement of standards. Reflection of surrounding objects is minimized and in compliance with requirement of standards	

1.4 Project Data

Project Leader:	Qi Dianyuan
Test Engineer:	Wang Tian
Testing Start Date:	May 6, 2024
Testing End Date:	May 31, 2024

1.5 Signature

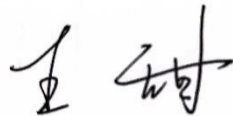

Wang Tian
(Prepared this test report)



Qi Dianyuan
(Reviewed this test report)

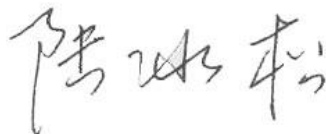

Lu Bingsong
Deputy Director of the laboratory
(Approved this test report)



2 Client Information

2.1 Applicant Information

Company Name:	COOSEA GROUP (HK) COMPANY LIMITED
Address/Post:	UNIT 5-6 16/F MULTIFIELD PLAZA 3-7A PRAT AVENUE TSIMSHATSUI KL
Contact Person:	Zhao jiandong
Contact Email:	zhaojiandong@cooseagroup.com
Telephone:	137-5984-9661
Fax	/

2.2 Manufacturer Information

Company Name:	COOSEA GROUP (HK) COMPANY LIMITED
Address/Post:	UNIT 5-6 16/F MULTIFIELD PLAZA 3-7A PRAT AVENUE TSIMSHATSUI KL
Contact Person:	Zhao jiandong
Contact Email:	zhaojiandong@cooseagroup.com
Telephone:	137-5984-9661
Fax	/

3 Equipment Under Test (EUT) and Ancillary Equipment (AE)

3.1 About EUT

Description:	Smart Phone
Model name:	SN509A/SN509C
Operating mode(s):	WCDMA B1/2/4/5/8 LTE Band:2/3/4/5/7/12/14/17/20/29/30/66 5G NR N2/5/30/66/77 BT, Wi-Fi(2.4G), Wi-Fi(5G), NFC

3.2 Internal Identification of EUT used during the test

EUT ID*	IMEI	HW Version	SW Version
EUT1	355548720000560	1.0	WFA131051
EUT2	352095330005335	1.0	WFA131051

*EUT ID: is used to identify the test sample in the lab internally.

3.3 Internal Identification of AE used during the test

AE ID*	Description	Model	SN	Manufacturer
AE1	Battery	BL-A67CT	/	Huizhou Highpower Technology Co., Ltd.

*AE ID: is used to identify the test sample in the lab internally.

3.4 Air Interfaces / Bands Indicating Operating Modes

Air-interface	Band(MHz)	Type	C63.19/tested	Simultaneous Transmissions	Name of Voice Service
WCDMA (UMTS)	850	VO	Yes	BT, WLAN	CMRS Voice
	1700				
	1900				
	HSPA	DT	Yes		MEET
LTE FDD	Band2/4/5/7/12/14/17/ 30/66	V/D	Yes	BT, WLAN	VoLTE, MEET
NR	N2/5/30/66/77	DT	Yes	BT, WLAN	MEET
BT	2450	DT	NA	WWAN	NA
WLAN	2450	V/D	Yes	WWAN	VoWiFi, MEET
WLAN	5G	V/D	Yes	WWAN	VoWiFi, MEET

NA: Not Applicable VO: Voice Only V/D: CMRS and IP Voice Service over Digital Transport DT: Digital Transport
 Note1= The device have similar frequency in some bands: 4/66,12/17 since the supported frequency spans for the smaller bands are completely cover by the larger bands, therefore, only larger bands were required to be tested for hearing-aid compliance.

4 Reference Documents

The following document listed in this section is referred for testing.

Reference	Title	Version
ANSI C63.19	American National Standard Methods of Measurement of Compatibility Between Wireless Communications Devices and Hearing Aids	2019 Edition
KDB285076 D01v06r04	Equipment Authorization Guidance for Hearing Aid Compatibility	2023 Edition
KDB285076 D02v04	Guidance for performing T-Coil tests for air interfaces supporting voice over IP (e.g., LTE and WiFi) to support CMRS based telephone services	2022 Edition
KDB285076 D03v01r06	Hearing aid compatibility frequently asked questions	2022 Edition

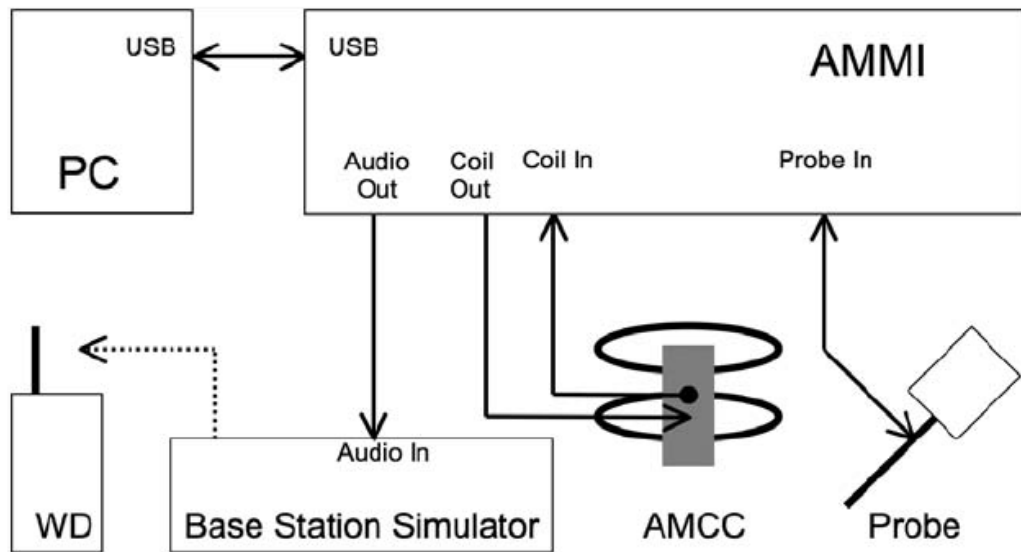

Figure 5.2 T-Coil setup with HAC Test Arch and AMCC

5.2 AM1D probe

The AM1D probe is an active probe with a single sensor. It is fully RF-shielded and has a rounded tip 6mm in diameter incorporating a pickup coil with its center offset 3mm from the tip and the sides. The symmetric signal preamplifier in the probe is fed via the shielded symmetric output cable from the AMMI with a 48V "phantom" voltage supply. The 7-pin connector on the back in the axis of the probe does not carry any signals. It is mounted to the DAE for the correct orientation of the sensor. If the probe axis is tilted 54.7 degree from the vertical, the sensor is approximately vertical when the signal connector is at the underside of the probe (cable hanging downwards).

Specification:

Frequency range	0.1~20kHz (RF sensitivity < -100dB, fully RF shielded)
Sensitivity	< -50dB A/m @ 1kHz
Pre-amplifier	40dB, symmetric
Dimensions	Tip diameter/length: 6/290mm, sensor according to ANSI-C63.19

5.3 AMCC

The Audio Magnetic Calibration coil is a Helmholtz Coil designed for calibration of the AM1D probe. The two horizontal coils generate a homogeneous magnetic field in the z direction. The DC input resistance is adjusted by a series resistor to approximately 500ohm, and a shunt resistor of 100ohm permits monitoring the current with a scale of 1:10

Port description:

Signal	Connector	Resistance
Coil In	BNC	Typically 500ohm
Coil Monitor	BNO	100ohm±1% (100mV corresponding to 1 A/m)

Specification:

Dimensions	370 x 370 x 196 mm, according to ANSI-C63.19
-------------------	--

5.4 AMMI



Figure 5.3 AMMI front panel

The Audio Magnetic Measuring Instrument (AMMI) is a desktop 19-inch unit containing a sampling unit, a waveform generator for test and calibration signals, and a USB interface.

Specification:

Sampling rate	48 kHz / 24 bit
Dynamic range	85 dB
Test signal generation	User selectable and predefined (vis PC)
Calibration	Auto-calibration / full system calibration using AMCC with monitor output
Dimensions	482 x 65 x 270 mm

5.5 Test Arch Phantom & Phone Positioner

The Test Arch phantom should be positioned horizontally on a stable surface. Reference markings on the Phantom allow the complete setup of all predefined phantom positions and measurement grids by manually teaching three points in the robot. It enables easy and well defined positioning of the phone and validation dipoles as well as simple teaching of the robot (Dimensions: 370 x 370 x 370 mm).

The Phone Positioner supports accurate and reliable positioning of any phone with effect on near field $< \pm 0.5$ dB.

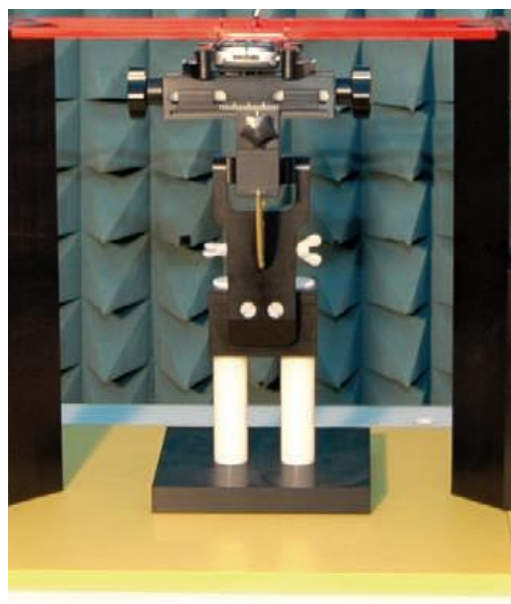

Figure 5.4 HAC Phantom & Device Holder

5.6 Robotic System Specifications

Specifications

Positioner: Stäubli Unimation Corp. Robot Model: RX160L

Repeatability: ± 0.02 mm

No. of Axis: 6

Data Acquisition Electronic (DAE) System

Cell Controller

Processor: Intel Core2

Clock Speed: 1.86GHz

Operating System: Windows 10

Data Converter

Features: Signal Amplifier, multiplexer, A/D converter, and control logic

Software: DASY6/8 cD6 HAC

Connecting Lines: Optical downlink for data and status info.

Optical uplink for commands and clock

5.7 T-Coil measurement points and reference plane

The T-Coil measurement plane, reference plane and other measurement parameters shall be:

- a) The reference plane is the planar area that contains the highest point in the area of the phone that normally rests against the user's ear. It is parallel to the centerline of the receiver area of the phone and is defined by the points of the receiver-end of the WD handset, which, in normal handset use, rest against the ear.
- b) The measurement plane is parallel to, and 10 mm in front of, the reference plane
- c) The reference axis is normal to the reference plane and passes through the center of the acoustic output (or the center of the hole array); or may be centered on or near a secondary inductive source. The actual location of the reference axis and resultant measurement area shall be noted in the test report.
- d) The measurement area shall be 50 mm by 50 mm. The measurement area for both desired ABM signal and undesired ABM field may be located where the transverse magnetic measurements are optimum with regard to the requirements. However, the measurement area should be in the vicinity of the acoustic output of the WD and shall be located in the same half of the phone as the WD receiver. In a WD handset with a centered receiver and a circularly symmetrical magnetic field, the measurement axis and the reference axis would coincide.
- e) Measurements of desired ABM signal strength and undesired ABM field are made at 2.0 mm ± 0.5 mm or 4 mm intervals in an X-Y measurement area pattern over the entire measurement area (676 measurement points total); either all measured, or measured plus interpolated.
- f) Desired ABM signal frequency response is measured at a single location at or near the maximum desired ABM signal strength location.
- g) The actual locations of the measurement points shall be noted in the test report.

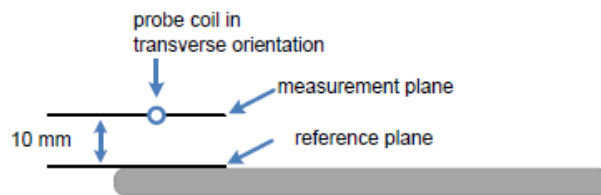
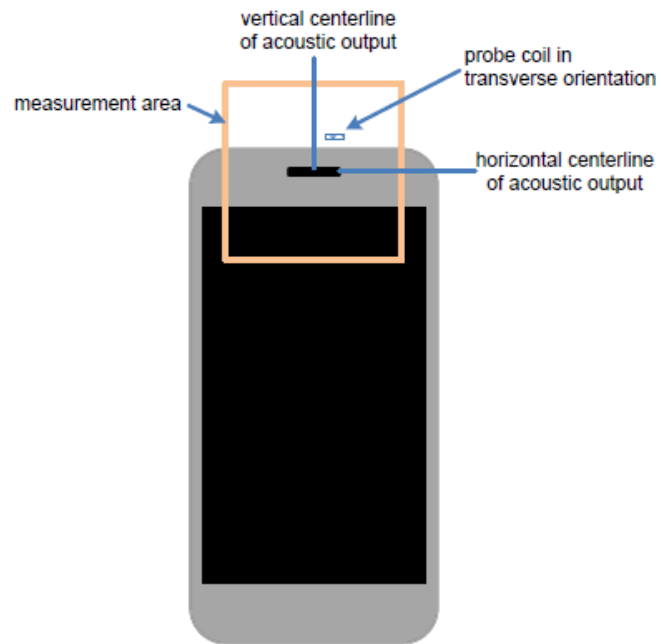

Figure 5.5 Measurement and reference planes probe orientation for WD audio frequency magnetic field measurements

6 T-Coil TEST PROCEDURES

The following steps summarize the basic test flow for determining desired ABM signal and undesired ABM field:

- a) A validation of the test setup and instrumentation shall be performed. This may be done using a TMFS or Helmholtz Coil. Measure the emissions and confirm that they are within tolerance of the expected values.
- b) Confirm that equipment that requires calibration has been calibrated, and that the noise level meets the requirements given in C63.19-2019 section 6.3.2.
- c) Position the WD in the test setup and connect the WD RF connector to a base station simulator.
- d) The drive level to the WD is set such that the reference input level specified in Table 6-1 is input to the base station simulator (or manufacturer's test mode equivalent) in the 1 kHz, 1/3 octave band. This drive level shall be used for the T-Coil signal test (desired ABM signal) at $f = 1$ kHz. Either a sine wave at 1025 Hz, or a voice-like signal, band-limited to the 1 kHz 1/3 octave, shall be used for the reference audio signal. If interference is found at 1025 Hz an alternative nearby reference audio signal frequency may be used.³⁵ The same drive level will be used for the desired ABM signal frequency response measurements at each 1/3 octave band center frequency. The WD volume control may be set at any level up to maximum, provided that a signal at any frequency at maximum modulation would not result in clipping or signal overload.
- e) At each measurement location over the measurement area and in the transverse orientation, measure and record the desired 1 kHz T-Coil magnetic signal (desired ABM signal) as described in Step c).
- f) At or near a location representing a maximum in the just-measured desired ABM signal, measure and record the desired T-Coil magnetic signals (desired ABM signal at f_i) in each individual ISO 266:1975 R10 standard 1/3 octave band. The desired audio band input frequency (f_i) shall be centered in each 1/3 octave band maintaining the same drive level as determined in Step c), and the reading taken for that band.³⁶ Equivalent methods of determining the frequency response may also be employed, such as fast Fourier transform (FFT) analysis using noise excitation or input-output comparison using simulated speech. The full-band integrated or half-band integrated probe output, may be used, as long as the appropriate calibration curve is applied to the measured result, so as to yield an accurate measurement of the field magnitude. (The resulting measurement shall be an accurate measurement in dB(A/m).) Compare the frequency response found to the requirements of section 7.
- g) At the same locations measured in Step d), measure and record the undesired broadband audio magnetic signal (undesired ABM field) with no audio signal applied (or digital zero applied, if appropriate) using the specified spectral weighting, the half-band integrator followed by the temporal weighting.
- h) Calculate and record the location and number of the measurement points that satisfy both the minimum desired ABM signal level and the maximum undesired ABM field level specified. Compare this to the requirements section 7 and record the result.
- i) Calculate and record the location and number of the measurement points that satisfy the maximum undesired ABM field level and distribution requirements specified in section 7.

Table 6-1:T-Coil signal quality categories

Standard	Protocol	Input (dBm0)
TIA-2000	CDMA	-18
TIA/EIA-136	TDMA (50 Hz)	-18
J-STD-007	GSM (217 Hz)	-16
T1/T1P1/3GPP (See Note 1)	UMTS (WCDMA)	-16
iDEN®	TDMA (22 Hz and 11 Hz)	-18
VoIP a (See Note 2)	Voice over Internet Protocol	-16
NOTE 1—For UMTS (Universal Mobile Telecommunications System), refer to 3GPP TS26.131 and TS26.132 (http://www.3gpp.org). NOTE 2—VoIP is used in this table as a general term specifying a group of voice services that use -16 dBm0 as their normal acoustic level. The group includes a variety of voice services, including Voice-over-LTE (VoLTE), Voice-over-IP-multimedia-subsystem (VoIMS), Voice-over-Wi-Fi (VoWiFi) and similar services. For 3G, LTE, and WLAN terminals used for Commercial Mobile Radio Service (CMRS) based telephony, refer to 3GPP TS26.131 and TS26.132.		

7 T-Coil PERFORMANCE REQUIREMENTS

In order to comply with the requirements for T-Coil use, a WD's tested operating modes shall simultaneously meet the requirements for minimum desired ABM signal level and maximum undesired ABM field contained in this part at the minimum specified number of scanned locations

7.1 T-Coil coupling qualifying field strengths

When measured as specified in ANSI C63.19, there are two groups of qualifying measurement points:

Primary group: A qualifying measurement point shall have its T-Coil signal, desired ABM signal, ≥ -18 dB(A/m) at 1 kHz, in a 1/3 octave band filter. These measurements shall be made with the WD operating at a reference input level as specified in Table 6.1. Simultaneously, the qualifying measurement point shall have its weighted magnetic noise, undesired ABM field ≤ -38 dB(A/m).

Secondary group: A qualifying measurement point shall have its weighted magnetic noise, undesired ABM field ≤ -38 dB(A/m). This group inherently includes all the members of the primary group.

7.2 Frequency response

The frequency response of the axial component of the magnetic field, measured in 1/3 octave bands, shall follow the response curve specified in this sub-clause, over the frequency range 300 Hz to 3000 Hz. Figure 7.1 and Figure 7.2 provide the boundaries for the specified frequency. These response curves are for true field strength measurements of the T-Coil signal. Thus the 6 dB/octave probe response has been corrected from the raw readings.

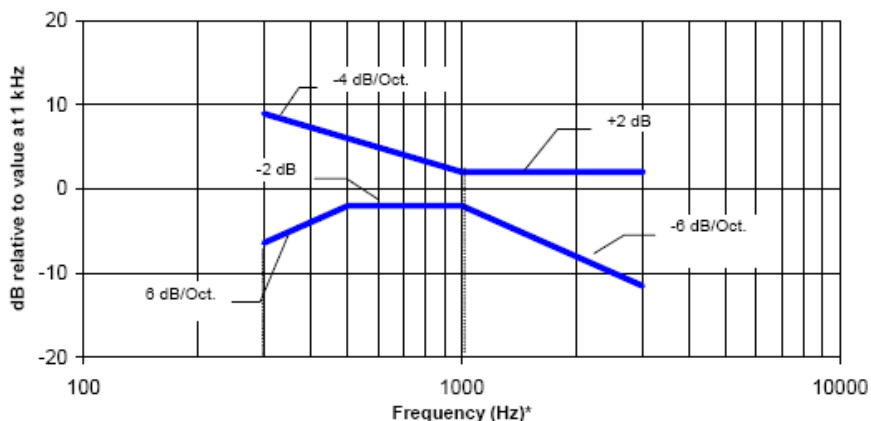

NOTE—Frequency response is between 300 Hz and 3000 Hz.

Figure 7.1—Magnetic field frequency response for WDs with a field ≤ -15 dB (A/m) at 1 kHz

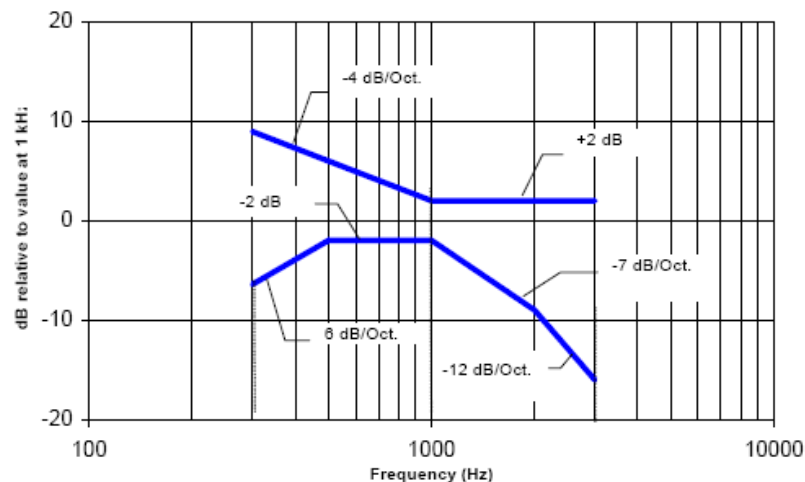

NOTE—Frequency response is between 300 Hz and 3000 Hz.

Figure 7.2—Magnetic field frequency response for WDs with a field that exceeds -15 dB(A/m) at 1 kHz

7.3 Desired ABM signal, undesired ABM field qualification requirements

For a WD that is expected to operate primarily in radio access technologies that include 2G GSM for legacy support, the WD shall be qualified for telecoil compatibility one of two ways:

- a) The WD shall be rated for telecoil use for all other voice operating modes, exclusive of 2G GSM, according to the section 7.3.1.
- b) If the WD is to be rated for telecoil use in its 2G GSM operating modes, these modes shall be qualified according to the section 7.3.2.

7.3.1 Non-2G GSM operating modes

The goal of this requirement is to ensure an adequate area where desired ABM signal is sufficiently strong to be heard clearly and a larger area where undesired ABM field is sufficiently low as to avoid undue annoyance. Qualifying measurement points shall fulfill the requirements of 7.1; both the primary and secondary group requirements shall be met:

The primary group shall include at least 75 measurement points.

The secondary group shall include at least 300 contiguous measurement points.

Additionally, to avoid an oddly shaped area of low noise, the secondary group shall include at least one longitudinal column of at least 10 contiguous qualifying points and at least one transverse row containing at least 15 contiguous qualifying points.

7.3.2 2G GSM operating modes

If the 2G GSM operating mode(s) are selected for qualification, the qualifying measurement points shall fulfill the requirements of 6.6.2; both the primary and secondary group requirements shall be met:

The primary group shall include at least 25 measurement points.

The secondary group shall include at least 125 contiguous measurement points.

8 3G Voice DUT CONFIGURATION

8.1 UMTS Codec Investigation

An investigation was performed to determine the audio codec configuration to be used for testing, the following tests results which the worst case codec would be remarked to be used for the testing for the DUT.

WCDMA/UMTS CMRS Codec Investigation

Codec Setting	AMR 12.2kbps	AMR 7.95kbps	AMR 4.75kbps	WB 6.6 kbps	Orientation	Band	Channel
Secondary Group Point Count	673	667	670	665	Y(Transverse)	WCDMA 1900	9400
Frequency Response	PASS	PASS	PASS	PASS			
Primary Group Contiguous Point Count	290	285	287	288			

9 VoLTE TEST SYSTEM SETUP AND DUT CONFIGURATION

9.1 Test System Setup for VoLTE over IMS T-coil Testing

The general test setup used for VoLTE over I Multimedia Subsystem (IMS) server. MS is shown below. The callbox used when performing VoLTE over IMS T-coil measurements is a CMW500. The Data Application Unit (DAU) of the CMW500 was used to simulate the IP Multimedia Subsystem (IMS) server.

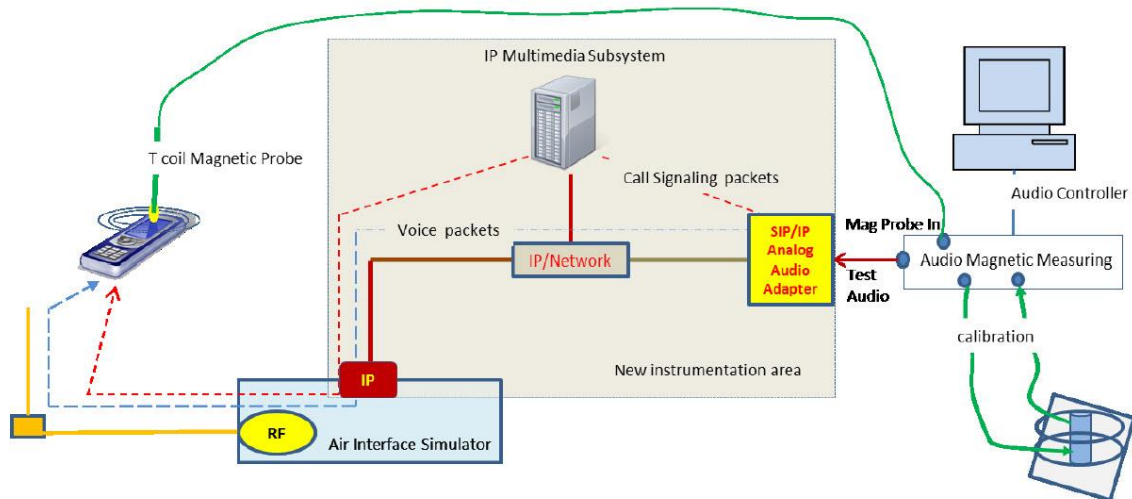

Figure 9.1 Test Setup for VoLTE over IMS T-coil Measurements

The following software/firmware was used to simulate the VoLTE server for testing:

Firmware	License Keys	Software Name
for LTE	KS500	LTE FDD R8 SIG BASIC
	KS550	LTE TDD R8 SIG BASIC
	KA100	IP APPL ENABLING IPv4
	KA150	IP APPL ENABLING IPv6
for Audio	KAA20	IP APPL IMS BASIC
	KM050	DATA APPL MEAS
	KS104	EVS SPEECH CODEC

9.2 Codec Configuration

An investigation was performed to determine the audio codec configuration to be used for testing. WB AMR 6.60kbps setting was used for the audio codec on the CMW500 for VoLTE over IMS T-coil testing. See below table for comparisons between different codecs and codec data rates:

AMR Codec Investigation – VoLTE over IMS

Codec Setting	WB AMR 23.85kbps	WB AMR 6.60kbps	NB AMR 12.2kbps	NB AMR 4.75kbps	Orientation	Band/BW	Channel
Secondary Group Point Count	463	446	463	464	Y(Transverse)	B2/20M	18900
Frequency Response	PASS	PASS	PASS	PASS			
Primary Group Contiguous Point Count	135	119	137	138			

EVS Codec Investigation – VoLTE over IMS

Codec Setting	EVS Primary WB 13.2kbps	EVS Primary WB 5.9kbps	EVS Primary NB 13.2kbps	EVS Primary NB 5.9kbps	Orientation	Band /BW	Channel
Secondary Group Point Count	454	459	460	470	Y(Transverse)	B2/20M	18900
Frequency Response	PASS	PASS	PASS	PASS			
Primary Group Contiguous Point Count	195	186	185	185			

9.3 Radio Configuration

An investigation was performed to determine the modulation, the bandwidth configuration and RB configuration to be used for testing. 20MHz BW, QPSK, 1RB, 50RB offset was used for the testing as the worst-case configuration for the handset. See below table for comparisons between different radio configurations:

VoLTE over IMS SNR by Radio Configuration

Band	Channel	Bandwidth [MHz]	Modulation	RB Size	RB Offset(%)	Primary Group Contiguous Point Count	Secondary Group Point Count
LTE B2	18900	20	QPSK	1	0	125	445
LTE B2	18900	20	QPSK	1	50	119	446



LTE B2	18900	20	QPSK	1	99	123	450
LTE B2	18900	20	QPSK	50	25	125	449
LTE B2	18900	20	QPSK	100	0	126	451
LTE B2	18900	20	16QAM	1	50	123	448
LTE B2	18900	20	64QAM	1	50	129	449
LTE B2	18900	10	QPSK	1	50	120	450
LTE B2	18900	5	QPSK	1	50	127	449
LTE B2	18900	1.4	QPSK	1	50	123	442

10 VoWiFi TEST SYSTEM SETUP AND DUT CONFIGURATION

10.1 Test System Setup for VoWiFi over IMS T-coil Testing

The general test setup used for VoWiFi over IMS, or CMRS WiFi Calling, is shown below. The callbox used when performing VoWiFi over IMS T-coil measurements is a CMW500. The Data Application Unit (DAU) of the CMW500 was used to simulate the IP Multimedia Subsystem (IMS) server.

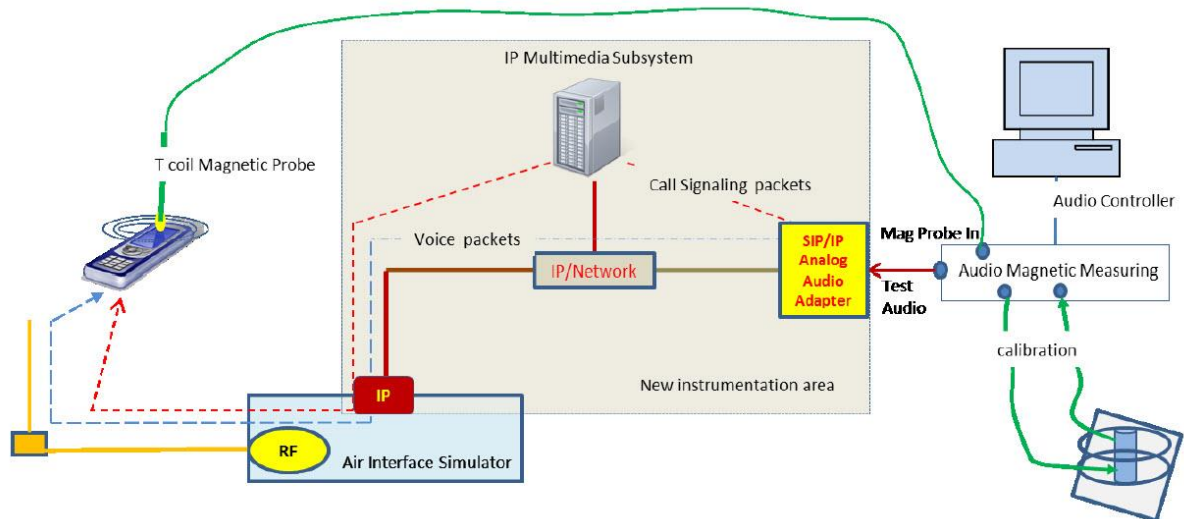

Figure 10.1 Test Setup for VoWiFi over IMS T-coil Measurements

The following software/firmware was used to simulate the VoWiFi server for testing:

Firmware	License Keys	Software Name
for WLAN	KS650	WLAN A/B/G SIG BASIC
	KS651	WLAN N SIG BASIC
	KA100	IP APPL ENABLING IPv4
	KA150	IP APPL ENABLING IPv6
for Audio	KAA20	IP APPL IMS BASIC
	KM050	DATA APPL MEAS
	KS104	EVS SPEECH CODEC

10.2 Codec Configuration

An investigation was performed to determine the audio codec configuration to be used for testing. The EVS Primary WB 5.9kbps setting was used for the audio codec on the CMW500 for VoWiFi over IMS T-coil testing. See below table for comparisons between different codecs and codec data rates:

AMR Codec Investigation – VoWiFi over IMS

Codec Setting	WB AMR 23.85kbps	WB AMR 6.60kbps	NB AMR 12.2kbps	NB AMR 4.75kbps	Orientation	Mode	Channel
Secondary Group Point Count	541	539	537	534	Y(Transverse)	2.4GHz 802.11b	6
Frequency Response	PASS	PASS	PASS	PASS			
Primary Group Contiguous Point Count	230	233	195	190			

EVS Codec Investigation – VoWiFi over IMS

Codec Setting	EVS Primary WB 13.2kbps	EVS Primary WB 5.9kbps	EVS Primary NB 13.2kbps	EVS Primary NB 5.9kbps	Orientation	Mode	Channel
Secondary Group Point Count	544	519	549	545	Y(Transverse)	2.4GHz 802.11b	6
Frequency Response	PASS	PASS	PASS	PASS			
Primary Group Contiguous Point Count	93	89	162	93			

10.3 Radio Configuration

An investigation was performed on applicable data rates and modulations to determine the radio configuration to be used for testing. See below table for comparisons between different radio configurations in each 802.11 standard:

Mode	Bandwidth [MHz]	Channel	Modulation	Data Rate [Mbps]	Primary Group Contiguous Point Count	Secondary Group Point Count
802.11b	20	6	DSSS	1	89	519
802.11b	20	6	CCK	11	90	521
802.11g	20	6	BPSK	6	151	563
802.11g	20	6	64-QAM	54	153	560
802.11n	20	6	BPSK	6.5	153	566
802.11n	20	6	64-QAM	78	155	365
802.11n	40	46	BPSK	13.5	174	613
802.11n	40	46	256-QAM	180	176	612
802.11ac	80	42	BPSK	29.3	164	566
802.11ac	80	42	256-QAM	390	167	570

11 OTT VoIP TEST SYSTEM AND DUT CONFIGURATION

11.1 Test System Setup for OTT VoIP T-coil Testing

OTT VoIP Application

Google Duo is a pre-installed application on the DUT which allows for VoIP calls in a head-to-ear scenario. Duo uses the OPUS audio codec and supports a bitrate range of 6kbps to 75kbps. All air interfaces capable of a data connection were evaluated with Google Duo. When HAC testing we are using the Google Duo version is 26.0.179825522.alpha.DEV and the bitrate configuration can find at settings → Voice call parameters settings → Audio codec bitrate(6-75kbps).

Test Procedure and Equipment Setup

The test procedure for OTT testing is identical to the section above, except for how the signal is sent to the DUT, as outlined in the diagram below.

The AMMI is connected to the support device's Mic via Audio Data Line. The support device is connected to the Internet via Wi-Fi and the DUT is connected to the mobile base station via the technology under test. Using the DUT's OTT application, a VoIP call is established with the support device. The test signal is sent from the DASY PC to the AMMI, from the AMMI to the support device, and finally to the DUT. To exercise the license antenna, the DUT was simultaneously connected to an external AP and to a mobile base station.

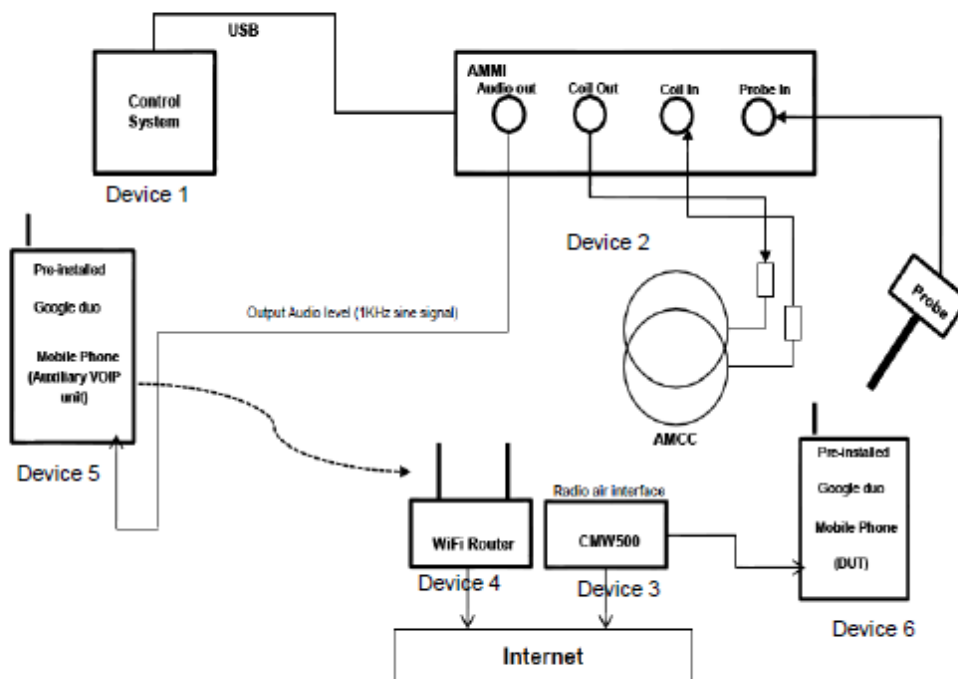

Codec Bit-rate Investigation

For a voice service/air interface, investigate the variations of bit-rate configurations and document the parameters (ABM1, ABM2, frequency response) for that voice service. It is only necessary to document this for one channel/band, the following tests results which the worst case codec would be remarked to be used for the testing for the handset.

Air Interface Investigation

Using the worst-case bit-rate and Radio Configuration, a limited set of bands/channel/ bandwidths were then tested to confirm that there is no effect to the test compliance when changing the band/channel/bandwidth, it is necessary to report only a set band/channel/bandwidth for each orientation for a voice service/air interface. The summary of evaluation results is described in section 13.5

11.2 Codec Configuration

An investigation was performed for each applicable data mode to determine the audio codec configuration to be used for testing. The 6kbps codec setting was used for the audio codec on the auxiliary VoIP unit for OTT VoIP T-coil testing. See below tables for comparisons between codec data rates on all applicable data modes:

Codec Investigation – OTT over HSPA

Codec Setting	64kbps	6kbps	Orientation	Band	Channel
Secondary Group Point Count	439	440	Y(Transverse)	WCDMA 1900	9800
Frequency Response	Pass	Pass			
Primary Group Contiguous Point Count	121	119			

Codec Investigation – OTT over LTE

Codec Setting	64kbps	6kbps	Orientation	Band/BW	Channel
Secondary Group Point Count	385	380	Y(Transverse)	B2/20M	18900
Frequency Response	Pass	Pass			
Primary Group Contiguous Point Count	84	82			

Codec Investigation – OTT over NR

Codec Setting	64kbps	6kbps	Orientation	Band/BW	Channel
Secondary Group Point Count	411	410	Y(Transverse)	N66/20M	349000
Frequency Response	Pass	Pass			
Primary Group	115	113			



Contiguous Point Count					
------------------------	--	--	--	--	--

Codec Investigation – OTT over WiFi

Codec Setting	64kbps	6kbps	Orientation	Band/BW	Channel
Secondary Group Point Count	405	407	Y(Transverse)	2.4GHz 802.11b	6
Frequency Response	Pass	Pass			
Primary Group Contiguous Point Count	108	106			

12 HAC T-Coil TEST DATA SUMMARY

12.1 Test Results for 3G

Band	Ch.	Primary Group Contiguous Point Count	Secondary Group Point Count	Secondary Group Max Longitudinal	Secondary Group Max Transverse	Frequency Response
W850	4407	269	607	26	26	PASS
W1900	9800	285	667	26	26	PASS
W1700	1637	253	596	26	26	PASS

Note:

1. Bluetooth and WiFi function is turn off and microphone is muted.
2. The volume is adjusted to maximum level during T-Coil testing.

12.2 Test Results for VoLTE

Band	Ch.	Bandwidth	Primary Group Contiguous Point Count	Secondary Group Point Count	Secondary Group Max Longitudinal	Secondary Group Max Transverse	Frequency Response
LTE B2	18900	20M	119	446	26	26	PASS
LTE B5	20525	10M	218	511	26	26	PASS
LTE B7	21100	20M	165	435	21	26	PASS
LTE B12	23095	10M	256	552	26	26	PASS
LTE B14	23330	10M	247	543	26	26	PASS
LTE B30	27710	10M	179	466	26	26	PASS
LTE B66	132322	20M	180	474	26	26	PASS

Note:

1. Bluetooth and WiFi function is turn off and microphone is muted.
2. The volume is adjusted to maximum level during T-Coil testing.

12.3 Test Results for VoLTE with NSA

Test results for 5G NR with NSA mode

Band	Primary Group Contiguous Point Count	Secondary Group Point Count	Secondary Group Max Longitudinal	Secondary Group Max Transverse	Frequency Response
B2-N5/30/66/77	107	432	20	26	PASS

B5-N2/30/66/77	106	432	20	26	PASS
B12-N2/30/66/77	106	431	20	26	PASS
B14-N2/30/66/77	107	433	20	26	PASS
B30-N2/5/66/77	80	434	20	26	PASS
B66-N2/5/30/66/77	108	436	20	26	PASS

Note:

1. Bluetooth and WiFi function is turn off and microphone is muted.
2. The volume is adjusted to maximum level during T-Coil testing.

12.4 Test Results for VoWiFi

Mode	Ch.	Band width	Primary Group Contiguous Point Count	Secondary Group Point Count	Secondary Group Max Longitudinal	Secondary Group Max Transverse	Frequency Response
802.11b	6	20M	89	519	24	26	PASS
802.11g	6	20M	151	563	26	26	PASS
802.11n	6	20M	153	566	26	26	PASS
802.11n	6	40M	161	578	26	26	PASS
802.11a	44	20M	174	610	26	26	PASS
802.11n	46	40M	174	613	26	26	PASS
802.11ac	42	80M	164	566	26	26	PASS
802.11a	60	20M	168	573	26	26	PASS
802.11a	124	20M	163	564	26	26	PASS
802.11a	157	20M	165	572	26	26	PASS

Note:

1. Bluetooth function is turn off and microphone is muted.
2. The volume is adjusted to maximum level during T-Coil testing.

12.5 Test Results for OTT VoIP

Test results for 3G

Band	Ch.	Primary Group Contiguous Point Count	Secondary Group Point Count	Secondary Group Max Longitudinal	Secondary Group Max Transverse	Frequency Response
W850	4407	118	442	26	26	PASS
W1900	9800	119	440	26	26	PASS
W1700	1637	110	440	26	26	PASS

Note: 1. Bluetooth and WiFi function is turn off and microphone is muted.

2. The volume is adjusted to maximum level during T-Coil testing.

Test results for LTE

Band	Ch.	Bandwidth	Primary Group Contiguous Point Count	Secondary Group Point Count	Secondary Group Max Longitudinal	Secondary Group Max Transverse	Frequency Response
LTE B2	18900	20M	82	380	19	26	PASS
LTE B5	20525	10M	112	431	22	26	PASS
LTE B7	21100	20M	88	405	20	26	PASS
LTE B12	23095	10M	120	419	21	26	PASS
LTE B14	23330	10M	116	416	21	26	PASS
LTE B30	27710	10M	78	377	18	26	PASS
LTE B66	13232 2	20M	88	385	19	26	PASS

Note:

1. Bluetooth and WiFi function is turn off and microphone is muted.

2. The volume is adjusted to maximum level during T-Coil testing.

Test results for 5G NR with SA mode

Band	Ch.	Bandwidth	Primary Group Contiguous Point Count	Secondary Group Point Count	Secondary Group Max Longitudinal	Secondary Group Max Transverse	Frequency Response
N2	376000	20M	93	390	18	26	PASS
N5	167300	10M	117	416	22	26	PASS
N30	462000	20M	81	372	17	26	PASS
N66	349000	10M	113	410	20	26	PASS
N77	633334	20M	88	381	17	26	PASS

Note:

1. Bluetooth and WiFi function is turn off and microphone is muted.

- The volume is adjusted to maximum level during T-Coil testing.

Test results for 5G NR with NSA mode

Band	Primary Group Contiguous Point Count	Secondary Group Point Count	Secondary Group Max Longitudinal	Secondary Group Max Transverse	Frequency Response
B2-N5/30/66/77	86	364	16	26	PASS
B5-N2/30/66/77	79	356	16	26	PASS
B12-N2/30/66/77	88	365	16	26	PASS
B14-N2/30/66/77	90	366	16	26	PASS
B30-N2/5/66/77	80	336	14	26	PASS
B66-N2/5/30/66/77	80	357	15	26	PASS

Note:

- Bluetooth and WiFi function is turn off and microphone is muted.
- The volume is adjusted to maximum level during T-Coil testing.

Test results for WiFi

Mode	Ch.	Band width	Primary Group Contiguous Point Count	Secondary Group Point Count	Secondary Group Max Longitudinal	Secondary Group Max Transverse	Frequency Response
802.11b	6	20M	106	407	24	26	PASS
802.11g	6	20M	119	442	25	26	PASS
802.11n	6	20M	117	438	24	26	PASS
802.11n	6	40M	132	447	25	26	PASS
802.11a	44	20M	122	443	26	26	PASS
802.11n	46	40M	122	444	25	26	PASS
802.11ac	42	80M	122	444	26	26	PASS

802.11a	60	20M	123	443	26	26	PASS
802.11a	124	20M	123	445	26	26	PASS
802.11a	157	20M	122	442	25	26	PASS

Note:

1. Bluetooth function is turn off and microphone is muted.
2. The volume is adjusted to maximum level during T-Coil testing.

12.6 Total Measurement Conclusion

Probe Position	Frequency Band(MHz)	Compliance
Transverse	WCDMA 850	PASS
	WCDMA 1700	PASS
	WCDMA 1900	PASS
	LTE Band2	PASS
	LTE Band4	PASS
	LTE Band5	PASS
	LTE Band7	PASS
	LTE Band12	PASS
	LTE Band14	PASS
	LTE Band17	PASS
	LTE Band30	PASS
	LTE Band66	PASS
	NR n2	PASS
	NR n5	PASS
	NR n30	PASS
	NR n66	PASS
	NR n77	PASS
	WLAN 2.4G	PASS
WLAN 5G	PASS	

13 MEASUREMENT UNCERTAINTY

Error Description	Unc. Value	Prob. Dist.	Div.	(ci) ABMd	(ci) ABMu	Std. Unc. ABMd	Std. Unc. ABMu
Probe Sensitivity							
Reference Level	±3.0 %	<i>N</i>	1	1	1	±3.0 %	±3.0 %
AMCC Geometry	±0.4 %	<i>R</i>	√3	1	1	±0.2 %	±0.2 %
AMCC Current	±1.0 %	<i>R</i>	√3	1	1	±0.6 %	±0.6 %
Probe Positioning during Calibr.	±0.1 %	<i>R</i>	√3	1	1	±0.1, %	±0.1 %
Noise Contribution	±0.7 %	<i>R</i>	√3	0.0143	1	±0.0 %	±0.4 %
Frequency Slope	±5.9 %	<i>R</i>	√3	0.1	1.0	±0.3 %	±3.5 %
Probe System							
Repeatability / Drift	±1.0 %	<i>R</i>	√3	1	1	±0.6 %	±0.6 %
Linearity / Dynamic Range	±0.6 %	<i>R</i>	√3	1	1	±0.4 %	±0.4 %
Acoustic Noise	±1.0 %	<i>R</i>	√3	0.1	1	±0.1 %	±0.6 %
Probe Angle	±1 %	<i>R</i>	√3	1	1	±0.6 %	±0.6 %
Spectral Processing	±0.9 %	<i>R</i>	√3	1	1	±0.5 %	±0.5 %
Integration Time	±0.6 %	<i>N</i>	1	1	5	±0.6 %	±3.0 %
Field Disturbation	±0.2 %	<i>R</i>	√3	1	1	±0.1 %	±0.1 %
Test Signal							
Ref. Signal Spectral Response	±0.6 %	<i>R</i>	√3	0	1	±0.0 %	±0.4 %
Positioning							
Probe Positioning	±1.9 %	<i>R</i>	√3	1	1	±1.1 %	±1.1 %
Phantom Thickness	±0.9 %	<i>R</i>	√3	1	1	±0.5 %	±0.5 %
DUT Positioning	±1.9 %	<i>R</i>	√3	1	1	±1.1 %	±1.1 %
External Contributions							
RF Interference	±0.0 %	<i>R</i>	√3	1	0.3	±0.0 %	±0.0 %
Test Signal Variation	±2.0 %	<i>R</i>	√3	1	1	±1.2 %	±1.2 %
Combined Uncertainty							
Combined Std. Uncertainty (ABM Field)						±3.9 %	±6.0 %
Expanded Std. Uncertainty						±7.8 %	±11.9 %

14 MAIN TEST INSTRUMENTS

List of Main Instruments

No.	Name	Type	Serial Number	Calibration Date	Valid Period
01	Audio Magnetic 1D Field Probe	AM1DV2	1064	July 14, 2023	One year
02	Audio Magnetic Calibration Coil	AMCC	1064	NCR	NCR
03	Audio Measuring Instrument	AMMI	1044	NCR	NCR
04	HAC Test Arch	N/A	1014	NCR	NCR
05	DAE	SPEAG DAE4	1524	October 20, 2023	One year
06	Software	DASY5 V5.0 Build 119.9	N/A	NCR	NCR
07	Software	SEMCAD V13.2 Build 87	N/A	NCR	NCR
08	Universal Radio Communication Tester	CMW 500	166370	July 4, 2023	One year
09	Universal Radio Communication Tester	CMX 500	102152	April 17, 2024	One year

END OF REPORT BODY

ANNEX A TEST LAYOUT

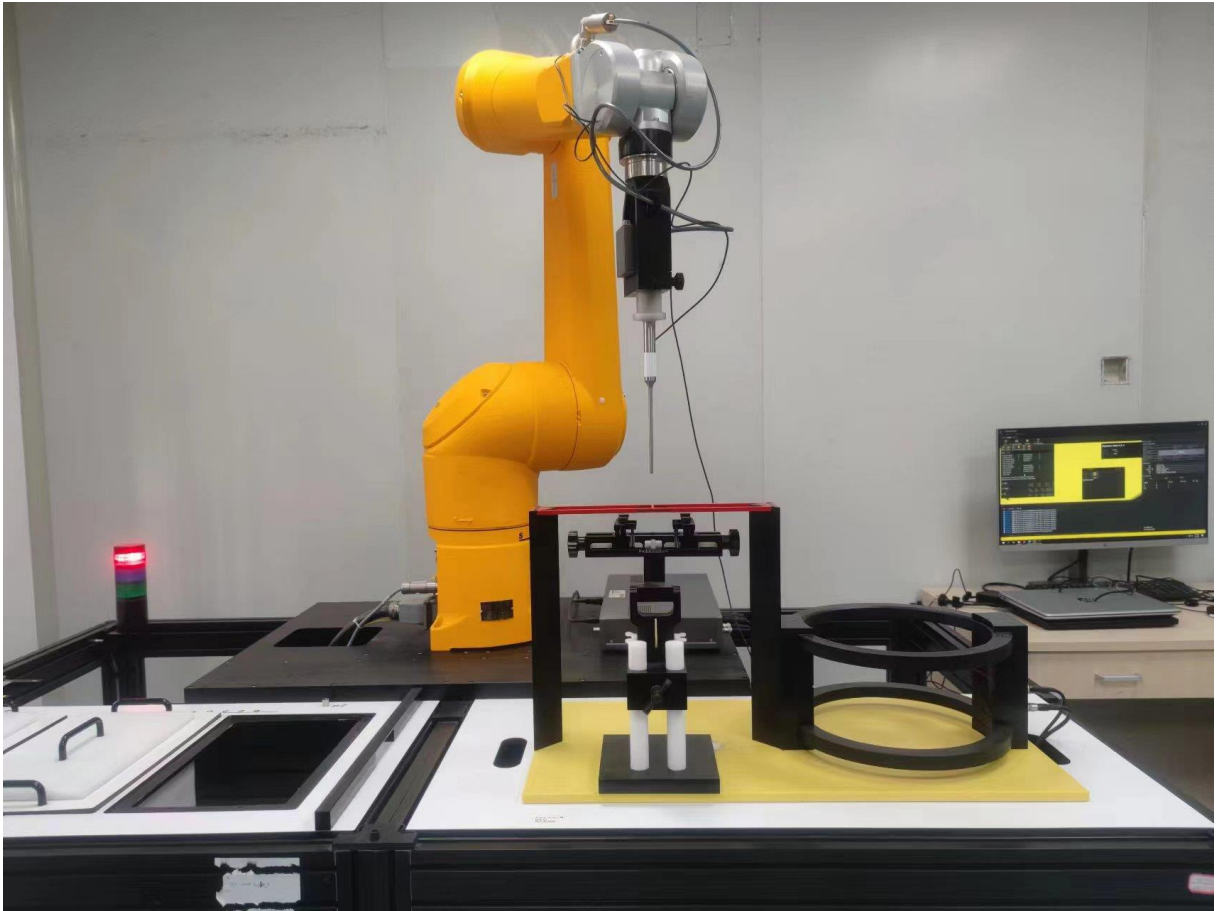

Picture A1: HAC T-Coil System Layout

ANNEX B TEST PLOTS

T-Coil B30-N77 Transverse

T-Coil Coupling Mode Test Report

Results

Primary Group Contiguous Point Count	Secondary Group Point Count	Secondary Group Max Longitudinal	Secondary Group Max Transverse
80	434	20	26



Fig B.2 T-Coil B30-N77

T-Coil LTE Band30 Transverse - OTT VoIP

T-Coil Coupling Mode Test Report

Results

Primary Group Contiguous Point Count	Secondary Group Point Count	Secondary Group Max Longitudinal	Secondary Group Max Transverse
78	377	18	26

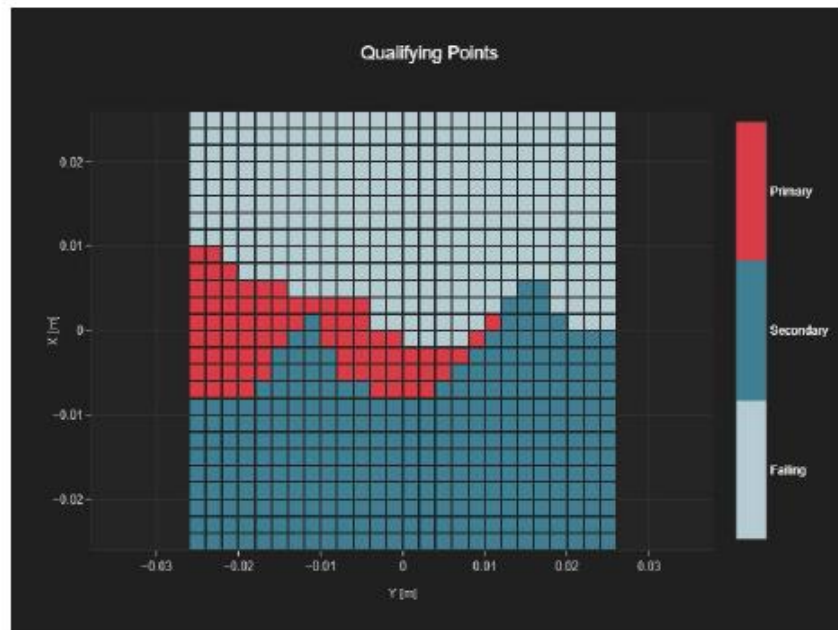

Fig B.4 T-Coil LTE Band30-OTT

ANNEX C FREQUENCY REPOSE CURVES

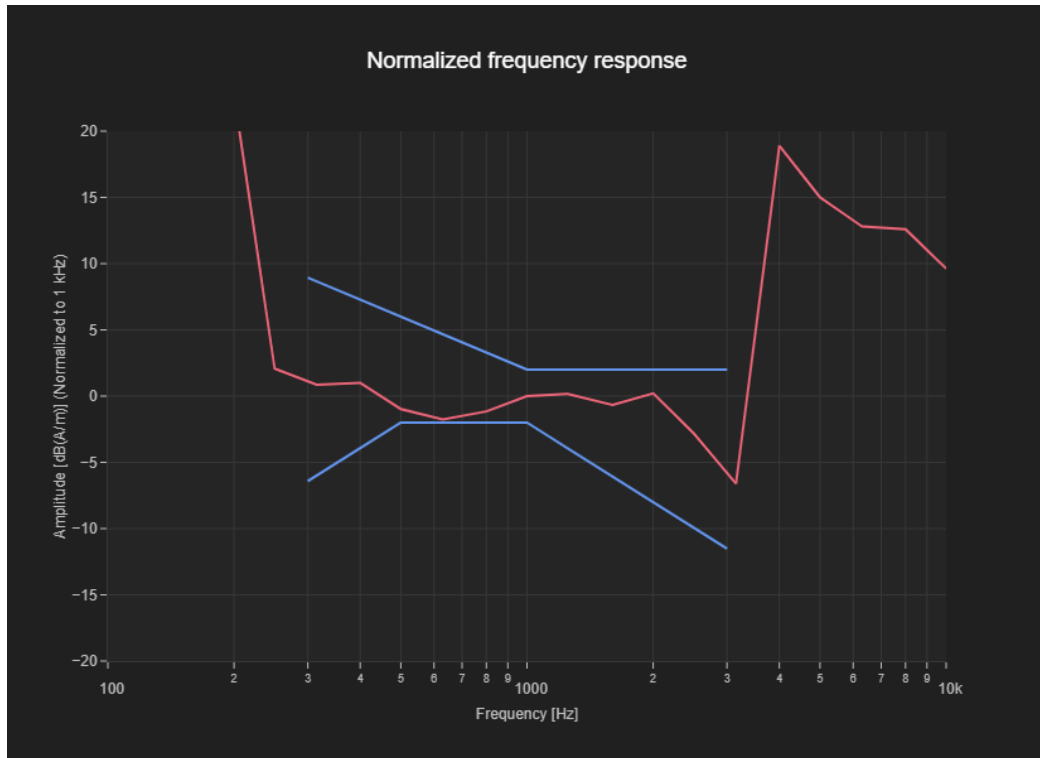

Figure C.1 Frequency Response of B30-N77

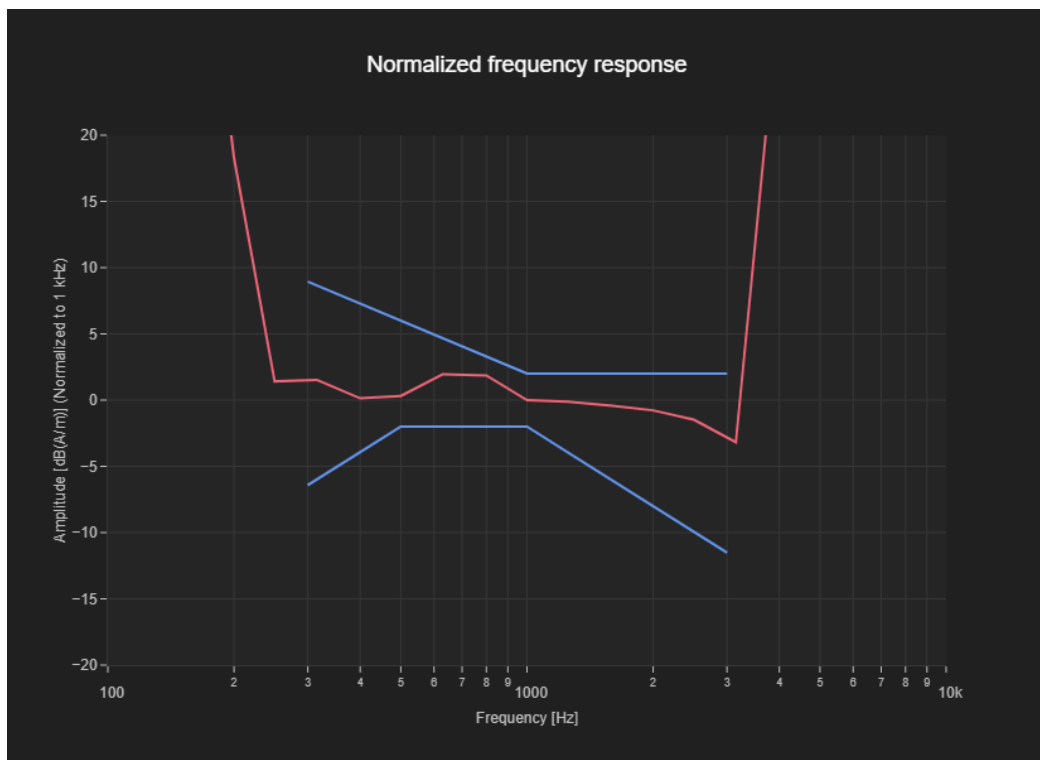

Figure C.2 Frequency Response of Band30-OTT

ANNEX D PROBE CALIBRATION CERTIFICATE

Calibration Laboratory of
Schmid & Partner
Engineering AG
 Zeughausstrasse 43, 8004 Zurich, Switzerland



S Schweizerischer Kalibrierdienst
C Service suisse d'étalonnage
S Servizio svizzero di taratura
S Swiss Calibration Service

Accredited by the Swiss Accreditation Service (SAS)
 The Swiss Accreditation Service is one of the signatories to the EA
 Multilateral Agreement for the recognition of calibration certificates

Accreditation No.: **SCS 0108**

Client **CTTL**
Beijing

Certificate No. **AM1DV2-1064_Jul23**

CALIBRATION CERTIFICATE			
Object	AM1DV2 - SN: 1064		
Calibration procedure(s)	QA CAL-24.v4 Calibration procedure for AM1D magnetic field probes and TMFS in the audio range		
Calibration date:	July 14, 2023		
This calibration certificate documents the traceability to national standards, which realize the physical units of measurements (SI). The measurements and the uncertainties with confidence probability are given on the following pages and are part of the certificate.			
All calibrations have been conducted in the closed laboratory facility: environment temperature (22 ± 3)°C and humidity < 70%.			
Calibration Equipment used (M&TE critical for calibration)			
Primary Standards	ID #	Cal Date (Certificate No.)	Scheduled Calibration
Keithley Multimeter Type 2001	SN: 0810278	29-Aug-22 (No. 34389)	Aug-23
Reference Probe AM1DV2	SN: 1008	20-Dec-22 (No. AM1DV2-1008_Dec22)	Dec-23
DAE4	SN: 781	03-Jan-23 (No. DAE4-781_Jan23)	Jan-24
Secondary Standards	ID #	Check Date (in house)	Scheduled Check
AMCC	SN: 1050	01-Oct-13 (in house check Oct-20)	Oct-23
AMMI Audio Measuring Instrument	SN: 1062	26-Sep-12 (in house check Oct-20)	Oct-23
Calibrated by:	Name Leif Klysner	Function Laboratory Technician	Signature
Approved by:	Sven Kühn	Technical Manager	
This calibration certificate shall not be reproduced except in full without written approval of the laboratory.			Issued: July 17, 2023

References

- [1] ANSI-C63.19-2007
American National Standard for Methods of Measurement of Compatibility between Wireless Communications Devices and Hearing Aids.
- [2] ANSI-C63.19-2019 (ANSI-C63.19-2011)
American National Standard, Methods of Measurement of Compatibility between Wireless Communications Devices and Hearing Aids.
- [3] DASY System Handbook

Description of the AM1D probe

The AM1D Audio Magnetic Field Probe is a fully shielded magnetic field probe for the frequency range from 100 Hz to 20 kHz. The pickup coil is compliant with the dimensional requirements of [1+2]. The probe includes a symmetric low noise amplifier for the signal available at the shielded 3 pin connector at the side. Power is supplied via the same connector (phantom power supply) and monitored via the LED near the connector. The 7 pin connector at the end of the probe does not carry any signals, but determines the angle of the sensor when mounted on the DAE. The probe supports mechanical detection of the surface.

The single sensor in the probe is arranged in a tilt angle allowing measurement of 3 orthogonal field components when rotating the probe by 120° around its axis. It is aligned with the perpendicular component of the field, if the probe axis is tilted nominally 35.3° above the measurement plane, using the connector rotation and sensor angle stated below.

The probe is fully RF shielded when operated with the matching signal cable (shielded) and allows measurement of audio magnetic fields in the close vicinity of RF emitting wireless devices according to [1+2] without additional shielding.

Handling of the item

The probe is manufactured from stainless steel. In order to maintain the performance and calibration of the probe, it must not be opened. The probe is designed for operation in air and shall not be exposed to humidity or liquids. For proper operation of the surface detection and emergency stop functions in a DASY system, the probe must be operated with the special probe cup provided (larger diameter).

Methods Applied and Interpretation of Parameters

- *Coordinate System:* The AM1D probe is mounted in the DASY system for operation with a HAC Test Arch phantom with AMCC Helmholtz calibration coil according to [3], with the tip pointing to "southwest" orientation.
- *Functional Test:* The functional test preceding calibration includes test of Noise level RF immunity (1kHz AM modulated signal). The shield of the probe cable must be well connected. Frequency response verification from 100 Hz to 10 kHz.
- *Connector Rotation:* The connector at the end of the probe does not carry any signals and is used for fixation to the DAE only. The probe is operated in the center of the AMCC Helmholtz coil using a 1 kHz magnetic field signal. Its angle is determined from the two minima at nominally +120° and -120° rotation, so the sensor in the tip of the probe is aligned to the vertical plane in z-direction, corresponding to the field maximum in the AMCC Helmholtz calibration coil.
- *Sensor Angle:* The sensor tilting in the vertical plane from the ideal vertical direction is determined from the two minima at nominally +120° and -120°. DASY system uses this angle to align the sensor for radial measurements to the x and y axis in the horizontal plane.
- *Sensitivity:* With the probe sensor aligned to the z-field in the AMCC, the output of the probe is compared to the magnetic field in the AMCC at 1 kHz. The field in the AMCC Helmholtz coil is given by the geometry and the current through the coil, which is monitored on the precision shunt resistor of the coil.

AM1D probe identification and configuration data

Item	AM1DV2 Audio Magnetic 1D Field Probe
Type No	SP AM1 001 AF
Serial No	1064

Overall length	296 mm
Tip diameter	6.0 mm (at the tip)
Sensor offset	3.0 mm (centre of sensor from tip)
Internal Amplifier	40 dB

Manufacturer / Origin	Schmid & Partner Engineering AG, Zurich, Switzerland
-----------------------	--

Calibration data

Connector rotation angle	(in DASY system)	102.9 °	+/- 3.6 ° (k=2)
Sensor angle	(in DASY system)	0.45 °	+/- 0.5 ° (k=2)
Sensitivity at 1 kHz	(in DASY system)	0.0657 V/(A/m)	+/- 2.2 % (k=2)

The reported uncertainty of measurement is stated as the standard uncertainty of measurement multiplied by the coverage factor k=2, which for a normal distribution corresponds to a coverage probability of approximately 95%.



ANNEX E DAE CALIBRATION CERTIFICATE



Add: No.52 HuaYuanBei Road, Haidian District, Beijing, 100191, China
Tel: +86-10-62304633-2117
E-mail: emf@caict.ac.cn <http://www.caict.ac.cn>



中国认可
国际互认
校准
CALIBRATION
CNAS L0570

Client : CTTL

Certificate No: 23J02Z80107

CALIBRATION CERTIFICATE

Object: DAE4 - SN: 1524

Calibration Procedure(s): FF-Z11-002-01
Calibration Procedure for the Data Acquisition Electronics (DAEx)

Calibration date: October 20, 2023

This calibration Certificate documents the traceability to national standards, which realize the physical units of measurements(SI). The measurements and the uncertainties with confidence probability are given on the following pages and are part of the certificate.

All calibrations have been conducted in the closed laboratory facility: environment temperature(22±3)°C and humidity<70%.

Calibration Equipment used (M&TE critical for calibration)

Primary Standards	ID #	Cal Date(Calibrated by, Certificate No.)	Scheduled Calibration
Process Calibrator 753	1971018	12-Jun-23 (CTTL, No.J23X05436)	Jun-24

	Name	Function	Signature
Calibrated by:	Yu Zongying	SAR Test Engineer	
Reviewed by:	Lin Hao	SAR Test Engineer	
Approved by:	Qi Dianyuan	SAR Project Leader	

Issued: October 26, 2023

This calibration certificate shall not be reproduced except in full without written approval of the laboratory.



Add: No.52 HuaYuanBei Road, Haidian District, Beijing, 100191, China
Tel: +86-10-62304633-2117
E-mail: emf@caict.ac.cn <http://www.caict.ac.cn>

Glossary:

DAE data acquisition electronics
Connector angle information used in DASY system to align probe sensor X to the robot coordinate system.

Methods Applied and Interpretation of Parameters:

- *DC Voltage Measurement:* Calibration Factor assessed for use in DASY system by comparison with a calibrated instrument traceable to national standards. The figure given corresponds to the full scale range of the voltmeter in the respective range.
- *Connector angle:* The angle of the connector is assessed measuring the angle mechanically by a tool inserted. Uncertainty is not required.
- The report provide only calibration results for DAE, it does not contain other performance test results.



Add: No.52 HuaYuanBei Road, Haidian District, Beijing, 100191, China
Tel: +86-10-62304633-2117
E-mail: emf@caict.ac.cn <http://www.caict.ac.cn>

DC Voltage Measurement

A/D - Converter Resolution nominal

High Range: 1LSB = 6.1μV, full range = -100...+300 mV

Low Range: 1LSB = 61nV, full range = -1.....+3mV

DASY measurement parameters: Auto Zero Time: 3 sec; Measuring time: 3 sec

Calibration Factors	X	Y	Z
High Range	406.142 ± 0.15% (k=2)	405.376 ± 0.15% (k=2)	405.679 ± 0.15% (k=2)
Low Range	3.99029 ± 0.7% (k=2)	4.01744 ± 0.7% (k=2)	3.99298 ± 0.7% (k=2)

Connector Angle

Connector Angle to be used in DASY system	83.5° ± 1 °
---	-------------



The photos of HAC test are presented in the additional document:

Appendix to test report No. 24T04Z100676-003/004

The photos of HAC test