

Report No.: SEWM2210000221RG04  
 Rev.: 01  
 Page: 1 of 79

# TEST REPORT

**Application No.:** SEWM2210000221RG  
**Applicant:** NetComm Wireless Pty Ltd  
**Address of Applicant:** Level 5, 18-20 Orion Road, Lane Cove, NSW, Australia  
**Manufacturer:** Casa Systems, Inc.  
**Address of Manufacturer:** 100 Old River Road Andover, MA 01810  
**EUT Description:** 5G Wi-Fi 6 Residential Gateway  
**Model No.:** CFW-4222

**Trade Mark:**   
 casa systems

**FCC ID:** XIA-CFW4222  
**Standards:** FCC 47 CFR Part 2, Subpart J  
 FCC 47 CFR Part 15, Subpart C

**Date of Receipt:** 2022/11/01  
**Date of Test:** 2022/11/21 to 2022/12/15  
**Date of Issue:** 2022/12/15

|                      |               |
|----------------------|---------------|
| <b>Test Result :</b> | <b>PASS *</b> |
|----------------------|---------------|

\* In the configuration tested, the EUT detailed in this report complied with the standards specified above.

Authorized Signature:

Panta Sun  
 Wireless Laboratory Manager



Unless otherwise agreed in writing, this document is issued by the Company subject to its General Conditions of Service printed overleaf, available on request or accessible at <http://www.sgs.com/en/Terms-and-Conditions.aspx> and, for electronic format documents, subject to Terms and Conditions for Electronic Documents at <http://www.sgs.com/en/Terms-and-Conditions/Terms-e-Documents.aspx>. Attention is drawn to the limitation of liability, indemnification and jurisdiction issues defined therein. Any holder of this document is advised that information contained hereon reflects the Company's findings at the time of its intervention only and within the limits of Client's instructions, if any. The Company's sole responsibility is to its Client and this document does not exonerate parties to a transaction from exercising all their rights and obligations under the transaction documents. This document cannot be reproduced except in full, without prior written approval of the Company. Any unauthorized alteration, forgery or falsification of the content or appearance of this document is unlawful and offenders may be prosecuted to the fullest extent of the law. Unless otherwise stated the results shown in this test report refer only to the sample(s) tested and such sample(s) are retained for 30 days only.  
**Attention: To check the authenticity of testing/inspection report & certificate, please contact us at telephone: (86-755) 8307 1443, or email: CN.Doccheck@sgs.com**

South of No. 6 Plant, No. 1, Runsheng Road, Suzhou Industrial Park, Suzhou Area, China (Jiangsu) Pilot Free Trade Zone 215000 t (86-512) 62992980 www.sgs.com.cn  
 中国·苏州·中国(江苏)自由贸易试验区苏州片区苏州工业园区润胜路1号的6号厂房南楼 邮编: 215000 t (86-512) 62992980 sgs.china@sgs.com

Report No.: SEWM2210000221RG04

Rev.: 01

Page: 2 of 79

# 1 Version

| Revision Record |         |            |          |          |
|-----------------|---------|------------|----------|----------|
| Version         | Chapter | Date       | Modifier | Remark   |
| 01              |         | 2022/12/15 |          | Original |

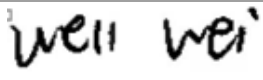
|                    |  |  |
|--------------------|--|--|
| <b>Prepared By</b> |  | <br><hr/> (Ives Cheng) / Test Engineer |
| <b>Checked By</b>  |  | <br><hr/> (Well Wei) / Reviewer        |



Unless otherwise agreed in writing, this document is issued by the Company subject to its General Conditions of Service printed overleaf, available on request or accessible at <http://www.sgs.com/en/Terms-and-Conditions.aspx> and, for electronic format documents, subject to Terms and Conditions for Electronic Documents at <http://www.sgs.com/en/Terms-and-Conditions/Terms-e-Documents.aspx>. Attention is drawn to the limitation of liability, indemnification and jurisdiction issues defined therein. Any holder of this document is advised that information contained hereon reflects the Company's findings at the time of its intervention only and within the limits of Client's instructions, if any. The Company's sole responsibility is to its Client and this document does not exonerate parties to a transaction from exercising all their rights and obligations under the transaction documents. This document cannot be reproduced except in full, without prior written approval of the Company. Any unauthorized alteration, forgery or falsification of the content or appearance of this document is unlawful and offenders may be prosecuted to the fullest extent of the law. Unless otherwise stated the results shown in this test report refer only to the sample(s) tested and such sample(s) are retained for 30 days only.

Attention: To check the authenticity of testing/inspection report & certificate, please contact us at telephone: (86-755) 8307 1443, or email: [CN.Doccheck@sgs.com](mailto:CN.Doccheck@sgs.com)

South of No. 6 Plant, No. 1, Runsheng Road, Suzhou Industrial Park, Suzhou Area, China (Jiangsu) Pilot Free Trade Zone 215000 t (86-512) 62992980 www.sgs.com.cn  
 中国·苏州·中国(江苏)自由贸易试验区苏州片区苏州工业园区润胜路1号的6号厂房南楼 邮编: 215000 t (86-512) 62992980 sgs.china@sgs.com

## 2 Test Summary

| Test Item   | FCC Rule No.     | Test Method                                       | Test Result | Result |
|---|------------------|---|-------------|--------|
| Antenna Requirement   | 15.203/15.247(b) | --  | Clause 4.1  | PASS   |
| AC Power Line Conducted Emission                                  | 15.207           | ANSI C63.10 2013<br>Section 6.2                   | Clause 4.2  | PASS   |
| Conducted Output Power  | 15.247 (b)(3)    | ANSI C63.10 2013<br>Section 11.9.2.3              | Clause 4.4  | PASS   |
| DTS (6 dB) Bandwidth & 99% Occupied Bandwidth                     | 15.247 (a)(2)    | ANSI C63.10 2013<br>Section 11.8 Option 2 / 6.9.3 | Clause 4.5  | PASS   |
| Power Spectral Density  | 15.247 (e)       | ANSI C63.10 2013<br>Section 11.10.2               | Clause 4.6  | PASS   |
| Band-edge for RF Conducted Emissions                              | 15.247(d)        | ANSI C63.10 2013<br>Section 11.11                 | Clause 4.7  | PASS   |
| RF Conducted Spurious Emissions                                   | 15.247(d)        | ANSI C63.10 2013<br>Section 11.11                 | Clause 4.8  | PASS   |
| Radiated Spurious Emissions                                       | 15.205/15.209    | ANSI C63.10 2013<br>Section 11.12                 | Clause 4.9  | PASS   |
| Restricted bands around fundamental frequency (Radiated Emission) | 15.205/15.209    | ANSI C63.10 2013<br>Section 11.12                 | Clause 4.10 | PASS   |



Unless otherwise agreed in writing, this document is issued by the Company subject to its General Conditions of Service printed overleaf, available on request or accessible at <http://www.sgs.com/en/Terms-and-Conditions.aspx> and, for electronic format documents, subject to Terms and Conditions for Electronic Documents at <http://www.sgs.com/en/Terms-and-Conditions/Terms-e-Documents.aspx>. Attention is drawn to the limitation of liability, indemnification and jurisdiction issues defined therein. Any holder of this document is advised that information contained hereon reflects the Company's findings at the time of its intervention only and within the limits of Client's instructions, if any. The Company's sole responsibility is to its Client and this document does not exonerate parties to a transaction from exercising all their rights and obligations under the transaction documents. This document cannot be reproduced except in full, without prior written approval of the Company. Any unauthorized alteration, forgery or falsification of the content or appearance of this document is unlawful and offenders may be prosecuted to the fullest extent of the law. Unless otherwise stated the results shown in this test report refer only to the sample(s) tested and such sample(s) are retained for 30 days only.

Attention: To check the authenticity of testing/inspection report & certificate, please contact us at telephone: (86-755) 8307 1443, or email: [CN.Doccheck@sgs.com](mailto:CN.Doccheck@sgs.com)

South of No. 6 Plant, No. 1, Runsheng Road, Suzhou Industrial Park, Suzhou Area, China (Jiangsu) Pilot Free Trade Zone 215000  
 中国·苏州·中国(江苏)自由贸易试验区苏州片区苏州工业园区润胜路1号的6号厂房南楼 邮编: 215000

t (86-512) 62992980 www.sgs.com.cn  
 t (86-512) 62992980 sgs.china@sgs.com

## Contents

|      |  |    |
|------|--|----|
| 1    | Version .....  | 2  |
| 2    | Test Summary .....   | 3  |
| 3    | General Information .....                                  | 5  |
| 3.1  | Details of Client .....                                    | 5  |
| 3.2  | Test Location .....  | 5  |
| 3.3  | Test Facility .....  | 5  |
| 3.4  | General Description of EUT .....                           | 6  |
| 3.5  | Test Environment .....                                     | 8  |
| 3.6  | Description of Support Units .....                         | 8  |
| 4    | Test results and Measurement Data .....                    | 9  |
| 4.1  | Antenna Requirement .....                                  | 9  |
| 4.2  | AC Power Line Conducted Emissions .....                    | 10 |
| 4.3  | Duty Cycle .....   | 16 |
| 4.4  | Conducted Output Power .....                               | 17 |
| 4.5  | DTS (6 dB) Bandwidth & 99% Occupied Bandwidth .....        | 18 |
| 4.6  | Power Spectral Density .....                               | 19 |
| 4.7  | Band-edge for RF Conducted Emissions .....                 | 20 |
| 4.8  | RF Conducted Spurious Emissions .....                      | 21 |
| 4.9  | Radiated Spurious Emissions .....                          | 22 |
| 4.10 | Restricted bands around fundamental frequency .....        | 25 |
| 5    | Measurement Uncertainty (95% confidence levels, k=2) ..... | 27 |
| 6    | Equipment List .....                                       | 28 |
| 7    | Photographs - Setup Photos .....                           | 30 |



Unless otherwise agreed in writing, this document is issued by the Company subject to its General Conditions of Service printed overleaf, available on request or accessible at <http://www.sgs.com/en/Terms-and-Conditions.aspx> and, for electronic format documents, subject to Terms and Conditions for Electronic Documents at <http://www.sgs.com/en/Terms-and-Conditions/Terms-e-Document.aspx>. Attention is drawn to the limitation of liability, indemnification and jurisdiction issues defined therein. Any holder of this document is advised that information contained hereon reflects the Company's findings at the time of its intervention only and within the limits of Client's instructions, if any. The Company's sole responsibility is to its Client and this document does not exonerate parties to a transaction from exercising all their rights and obligations under the transaction documents. This document cannot be reproduced except in full, without prior written approval of the Company. Any unauthorized alteration, forgery or falsification of the content or appearance of this document is unlawful and offenders may be prosecuted to the fullest extent of the law. Unless otherwise stated the results shown in this test report refer only to the sample(s) tested and such sample(s) are retained for 30 days only.

Attention: To check the authenticity of testing/inspection report & certificate, please contact us at telephone: (86-755) 8307 1443, or email: [CN.Doccheck@sgs.com](mailto:CN.Doccheck@sgs.com)

South of No. 6 Plant, No. 1, Runsheng Road, Suzhou Industrial Park, Suzhou Area, China (Jiangsu) Pilot Free Trade Zone 215000  
 中国·苏州·中国(江苏)自由贸易试验区苏州片区苏州工业园区润胜路1号的6号厂房南楼 邮编: 215000

t (86-512) 62992980 www.sgs.com.cn  
 t (86-512) 62992980 sgs.china@sgs.com

### 3 General Information

#### 3.1 Details of Client

|                          |  |
|--------------------------|--|
| Applicant:               | NetComm Wireless Pty Ltd                             |
| Address of Applicant:    | Level 5, 18-20 Orion Road, Lane Cove, NSW, Australia |
| Manufacturer:            | Casa Systems, Inc.                                   |
| Address of Manufacturer: | 100 Old River Road Andover, MA 01810                 |

#### 3.2 Test Location

|                |  |
|----------------|--|
| Company:       | SGS-CSTC Standards Technical Services (Suzhou) Co., Ltd.   |
| Address:       | South of No. 6 Plant, No. 1, Runsheng Road, Suzhou Industrial Park, Suzhou Area, China (Jiangsu) Pilot Free Trade Zone |
| Post code:     | 215000   |
| Test engineer: | Ives Cheng, Tizzy Song   |

#### 3.3 Test Facility

The test facility is recognized, certified, or accredited by the following organizations:

- **A2LA (Certificate No. 6336.01)**

SGS-CSTC STANDARDS TECHNICAL SERVICES (SUZHOU) CO., LTD. is accredited by the American Association for Laboratory Accreditation(A2LA). Certificate No. 6336.01.

- **Innovation, Science and Economic Development Canada**

SGS-CSTC STANDARDS TECHNICAL SERVICES (SUZHOU) CO., LTD. has been recognized by ISED as an accredited testing laboratory.

CAB identifier: CN0120.

IC#: 27594.

- **FCC –Designation Number: CN1312**

SGS-CSTC STANDARDS TECHNICAL SERVICES (SUZHOU) CO., LTD. has been recognized as an accredited testing laboratory.

Designation Number: CN1312.

Test Firm Registration Number: 717327



Unless otherwise agreed in writing, this document is issued by the Company subject to its General Conditions of Service printed overleaf, available on request or accessible at <http://www.sgs.com/en/Terms-and-Conditions.aspx> and, for electronic format documents, subject to Terms and Conditions for Electronic Documents at <http://www.sgs.com/en/Terms-and-Conditions/Terms-e-Documents.aspx>. Attention is drawn to the limitation of liability, indemnification and jurisdiction issues defined therein. Any holder of this document is advised that information contained hereon reflects the Company's findings at the time of its intervention only and within the limits of Client's instructions, if any. The Company's sole responsibility is to its Client and this document does not exonerate parties to a transaction from exercising all their rights and obligations under the transaction documents. This document cannot be reproduced except in full, without prior written approval of the Company. Any unauthorized alteration, forgery or falsification of the content or appearance of this document is unlawful and offenders may be prosecuted to the fullest extent of the law. Unless otherwise stated the results shown in this test report refer only to the sample(s) tested and such sample(s) are retained for 30 days only.  
**Attention: To check the authenticity of testing/inspection report & certificate, please contact us at telephone: (86-755) 8307 1443, or email: CN.Doccheck@sgs.com**

South of No. 6 Plant, No. 1, Runsheng Road, Suzhou Industrial Park, Suzhou Area, China (Jiangsu) Pilot Free Trade Zone 215000 t (86-512) 62992980 www.sgs.com.cn  
 中国·苏州·中国(江苏)自由贸易试验区苏州片区苏州工业园区润胜路1号的6号厂房南楼 邮编: 215000 t (86-512) 62992980 sgs.china@sgs.com

### 3.4 General Description of EUT

|  |  |                 |
|--|--|-----------------|
| EUT Description:   | 5G Wi-Fi 6 Residential Gateway   |                 |
| Model No.:   | CFW-4222   |                 |
| Trade Mark:  | <br>casa systems  |                 |
| Hardware Version:  | V1.1   |                 |
| Software Version:  | CFW4222-CS.NA  |                 |
| IMEI:  | RF Conducted   | 863109050014732 |
|  | RSE & AC power line  | 863109050015952 |
| Operation Frequency:   | 2400MHz~2483.5MHz<br>$f_c = 2402 \text{ MHz} + N * 2 \text{ MHz}$ , where:<br>- $f_c$ = "Operating Frequency" in MHz,<br>- $N$ = "Channel Number" with the range from 0 to 39. |                 |
| Bluetooth version:   | Bluetooth V5.1   |                 |
| Modulation Type:   | GFSK   |                 |
| Number of Channel:   | 40   |                 |
| Rates Type*:   | <input checked="" type="checkbox"/> Provided by client   |                 |
|  | 1M PHY   | 2M PHY          |
| Antenna Type:  | PCB Antenna  |                 |
| Antenna Gain:  | 4.08dBi (Ant1)   |                 |
|  | Note:<br>The antenna gain are derived from the gain information report provided by the manufacturer.   |                 |
| RF Cable:  | 1.0dB  |                 |
| Note: *Since the above data and/or information is provided by the client relevant results or conclusions of this report are only made for these data and/or information, SGS is not responsible for the authenticity, integrity and results of the data and information and/or the validity of the conclusion.<br>Remark:<br>As above information is provided and confirmed by the applicant. SGS is not liable to the accuracy, suitability, reliability or/and integrity of the information. |  |                 |

#### Accessory:

| Description | Manufacturer                                    | Model No.       | Power Rating   |
|-------------|---|-----------------|--|
| Adapter     | Shenzhen Keyu Power Supply Technology Co., Ltd. | KA36B-1203000US | Input:100- 240V~, 50/60Hz, 1.0A Max, Output:12VDC, 3000 mA |



Unless otherwise agreed in writing, this document is issued by the Company subject to its General Conditions of Service printed overleaf, available on request or accessible at <http://www.sgs.com/en/Terms-and-Conditions.aspx> and, for electronic format documents, subject to Terms and Conditions for Electronic Documents at <http://www.sgs.com/en/Terms-and-Conditions/Terms-e-Documents.aspx>. Attention is drawn to the limitation of liability, indemnification and jurisdiction issues defined therein. Any holder of this document is advised that information contained hereon reflects the Company's findings at the time of its intervention only and within the limits of Client's instructions, if any. The Company's sole responsibility is to its Client and this document does not exonerate parties to a transaction from exercising all their rights and obligations under the transaction documents. This document cannot be reproduced except in full, without prior written approval of the Company. Any unauthorized alteration, forgery or falsification of the content or appearance of this document is unlawful and offenders may be prosecuted to the fullest extent of the law. Unless otherwise stated the results shown in this test report refer only to the sample(s) tested and such sample(s) are retained for 30 days only.

Attention: To check the authenticity of testing/inspection report & certificate, please contact us at telephone: (86-755) 8307 1443, or email: [CN.Doccheck@sgs.com](mailto:CN.Doccheck@sgs.com)

South of No. 6 Plant, No. 1, Runsheng Road, Suzhou Industrial Park, Suzhou Area, China (Jiangsu) Pilot Free Trade Zone 215000  
 中国·苏州·中国(江苏)自由贸易试验区苏州片区苏州工业园区润胜路1号的6号厂房南楼 邮编: 215000

t (86-512) 62992980 www.sgs.com.cn  
 t (86-512) 62992980 sgs.china@sgs.com

| Operation Frequency of each channel |           |         |           |         |           |         |           |
|-------------------------------------|-----------|---------|-----------|---------|-----------|---------|-----------|
| Channel                             | Frequency | Channel | Frequency | Channel | Frequency | Channel | Frequency |
| 0                                   | 2402MHz   | 10      | 2422MHz   | 20      | 2442MHz   | 30      | 2462MHz   |
| 1                                   | 2404MHz   | 11      | 2424MHz   | 21      | 2444MHz   | 31      | 2464MHz   |
| 2                                   | 2406MHz   | 12      | 2426MHz   | 22      | 2446MHz   | 32      | 2466MHz   |
| 3                                   | 2408MHz   | 13      | 2428MHz   | 23      | 2448MHz   | 33      | 2468MHz   |
| 4                                   | 2410MHz   | 14      | 2430MHz   | 24      | 2450MHz   | 34      | 2470MHz   |
| 5                                   | 2412MHz   | 15      | 2432MHz   | 25      | 2452MHz   | 35      | 2472MHz   |
| 6                                   | 2414MHz   | 16      | 2434MHz   | 26      | 2454MHz   | 36      | 2474MHz   |
| 7                                   | 2416MHz   | 17      | 2436MHz   | 27      | 2456MHz   | 37      | 2476MHz   |
| 8                                   | 2418MHz   | 18      | 2438MHz   | 28      | 2458MHz   | 38      | 2478MHz   |
| 9                                   | 2420MHz   | 19      | 2440MHz   | 29      | 2460MHz   | 39      | 2480MHz   |

Remark:

In section 15.31(m), regards to the operating frequency range over 10 MHz, the Lowest frequency, the middle frequency, and the highest frequency of channel were selected to perform the test, and the selected channel see below:

| Channel                   | Frequency |
|---------------------------|-----------|
| The Lowest channel(CH0)   | 2402MHz   |
| The Middle channel(CH19)  | 2440MHz   |
| The Highest channel(CH39) | 2480MHz   |



Unless otherwise agreed in writing, this document is issued by the Company subject to its General Conditions of Service printed overleaf, available on request or accessible at <http://www.sgs.com/en/Terms-and-Conditions.aspx> and, for electronic format documents, subject to Terms and Conditions for Electronic Documents at <http://www.sgs.com/en/Terms-and-Conditions/Terms-e-Documents.aspx>. Attention is drawn to the limitation of liability, indemnification and jurisdiction issues defined therein. Any holder of this document is advised that information contained hereon reflects the Company's findings at the time of its intervention only and within the limits of Client's instructions, if any. The Company's sole responsibility is to its Client and this document does not exonerate parties to a transaction from exercising all their rights and obligations under the transaction documents. This document cannot be reproduced except in full, without prior written approval of the Company. Any unauthorized alteration, forgery or falsification of the content or appearance of this document is unlawful and offenders may be prosecuted to the fullest extent of the law. Unless otherwise stated the results shown in this test report refer only to the sample(s) tested and such sample(s) are retained for 30 days only.  
**Attention: To check the authenticity of testing/inspection report & certificate, please contact us at telephone: (86-755) 8307 1443, or email: CN.Doccheck@sgs.com**

South of No. 6 Plant, No. 1, Runsheng Road, Suzhou Industrial Park, Suzhou Area, China (Jiangsu) Pilot Free Trade Zone 215000 t (86-512) 62992980 www.sgs.com.cn  
 中国·苏州·中国(江苏)自由贸易试验区苏州片区苏州工业园区润胜路1号的6号厂房南楼 邮编: 215000 t (86-512) 62992980 sgs.china@sgs.com

### 3.5 Test Environment

|   |  |            |
|---|--|------------|
| Environment Parameter                                   | 101.0 kPa Selected Values During Tests |            |
| Relative Humidity                                       | 44-46 % RH Ambient                     |            |
| Value   | Temperature(°C)                        | Voltage(V) |
| NTNV  | 22~23                                  | 12         |
| Remark:<br>NV: Normal Voltage<br>NT: Normal Temperature |  |            |

### 3.6 Description of Support Units

The EUT has been tested as an independent unit.



Unless otherwise agreed in writing, this document is issued by the Company subject to its General Conditions of Service printed overleaf, available on request or accessible at <http://www.sgs.com/en/Terms-and-Conditions.aspx> and, for electronic format documents, subject to Terms and Conditions for Electronic Documents at <http://www.sgs.com/en/Terms-and-Conditions/Terms-e-Documents.aspx>. Attention is drawn to the limitation of liability, indemnification and jurisdiction issues defined therein. Any holder of this document is advised that information contained hereon reflects the Company's findings at the time of its intervention only and within the limits of Client's instructions, if any. The Company's sole responsibility is to its Client and this document does not exonerate parties to a transaction from exercising all their rights and obligations under the transaction documents. This document cannot be reproduced except in full, without prior written approval of the Company. Any unauthorized alteration, forgery or falsification of the content or appearance of this document is unlawful and offenders may be prosecuted to the fullest extent of the law. Unless otherwise stated the results shown in this test report refer only to the sample(s) tested and such sample(s) are retained for 30 days only.  
**Attention: To check the authenticity of testing/inspection report & certificate, please contact us at telephone: (86-755) 8307 1443, or email: CN.Doccheck@sgs.com**

South of No. 6 Plant, No. 1, Runsheng Road, Suzhou Industrial Park, Suzhou Area, China (Jiangsu) Pilot Free Trade Zone 215000  
 中国·苏州·中国(江苏)自由贸易试验区苏州片区苏州工业园区润胜路1号的6号厂房南楼 邮编: 215000

t (86-512) 62992980 www.sgs.com.cn  
 t (86-512) 62992980 sgs.china@sgs.com



## 4 Test results and Measurement Data

### 4.1 Antenna Requirement

|  |  |
|--|--|
| <b>Standard requirement:</b>   | 47 CFR Part 15C Section 15.203 /247(b) |
| <p>15.203 requirement:<br/>An intentional radiator shall be designed to ensure that no antenna other than that furnished by the responsible party shall be used with the device. The use of a permanently attached antenna or of an antenna that uses a unique coupling to the intentional radiator, the manufacturer may design the unit so that a broken antenna can be replaced by the user, but the use of a standard antenna jack or electrical connector is prohibited.</p> <p>15.247(b) (4) requirement:<br/>The conducted output power limit specified in paragraph (b) of this section is based on the use of antennas with directional gains that do not exceed 6 dBi. Except as shown in paragraph (c) of this section, if transmitting antennas of directional gain greater than 6 dBi are used, the conducted output power from the intentional radiator shall be reduced below the stated values in paragraphs (b)(1), (b)(2), and (b)(3) of this section, as appropriate, by the amount in dB that the directional gain of the antenna exceeds 6 dBi.</p> |  |
| <p>The antenna is PCB Antenna and no consideration of replacement.<br/>The best case gain of the antenna is 4.08dBi(Ant1). *</p> <p><i>*Note:<br/>The antenna gain are derived from the gain information report provided by the manufacturer.</i></p> <p><i>Remark:<br/>As above information is provided and confirmed by the applicant. SGS is not liable to the accuracy, suitability, reliability or/and integrity of the information.</i></p>  |  |



Unless otherwise agreed in writing, this document is issued by the Company subject to its General Conditions of Service printed overleaf, available on request or accessible at <http://www.sgs.com/en/Terms-and-Conditions.aspx> and, for electronic format documents, subject to Terms and Conditions for Electronic Documents at <http://www.sgs.com/en/Terms-and-Conditions/Terms-e-Documents.aspx>. Attention is drawn to the limitation of liability, indemnification and jurisdiction issues defined therein. Any holder of this document is advised that information contained hereon reflects the Company's findings at the time of its intervention only and within the limits of Client's instructions, if any. The Company's sole responsibility is to its Client and this document does not exonerate parties to a transaction from exercising all their rights and obligations under the transaction documents. This document cannot be reproduced except in full, without prior written approval of the Company. Any unauthorized alteration, forgery or falsification of the content or appearance of this document is unlawful and offenders may be prosecuted to the fullest extent of the law. Unless otherwise stated the results shown in this test report refer only to the sample(s) tested and such sample(s) are retained for 30 days only.

Attention: To check the authenticity of testing/inspection report & certificate, please contact us at telephone: (86-755) 8307 1443, or email: [CN.Doccheck@sgs.com](mailto:CN.Doccheck@sgs.com)

South of No. 6 Plant, No. 1, Runsheng Road, Suzhou Industrial Park, Suzhou Area, China (Jiangsu) Pilot Free Trade Zone 215000  
中国·苏州·中国(江苏)自由贸易试验区苏州片区苏州工业园区润胜路1号的6号厂房南楼 邮编: 215000

t (86-512) 62992980 www.sgs.com.cn  
t (86-512) 62992980 sgs.china@sgs.com

### 4.2 AC Power Line Conducted Emissions

|  |   |              |           |
|--|---|--------------|-----------|
| Test Requirement:                                | 47 CFR Part 15C Section 15.207  |              |           |
| Test Method:                                     | ANSI C63.10: 2013 Section 6.2   |              |           |
| Test Frequency Range:                            | 150kHz to 30MHz   |              |           |
| Receiver Setup:                                  | RBW = 9kHz, VBW = 30kHz   |              |           |
| Limit:   | Frequency range(MHz)  | Limit (dBuV) |           |
|  |   | Quasi-peak   | Average   |
|  | 0.15-0.5  | 66 to 56*    | 56 to 46* |
|  | 0.5-5   | 56           | 46        |
|  | 5-30  | 60           | 50        |
| * Decreases with the logarithm of the frequency. |   |              |           |
| Test Procedure:                                  | <ol style="list-style-type: none"> <li>1) The mains terminal disturbance voltage test was conducted in a shielded room.</li> <li>2) The EUT was connected to AC power source through a LISN 1 (Line Impedance Stabilization Network) which provides a 50Ω/50μH + 5Ω linear impedance. The power cables of all other units of the EUT were connected to a second LISN 2, which was bonded to the ground reference plane in the same way as the LISN 1 for the unit being measured. A multiple socket outlet strip was used to connect multiple power cables to a single LISN provided the rating of the LISN was not exceeded.</li> <li>3) The tabletop EUT was placed upon a non-metallic table 0.8m above the ground reference plane. And for floor-standing arrangement, the EUT was placed on the horizontal ground reference plane.</li> <li>4) The test was performed with a vertical ground reference plane. The rear of the EUT shall be 0.4 m from the vertical ground reference plane. The vertical ground reference plane was bonded to the horizontal ground reference plane. The LISN 1 was placed 0.8 m from the boundary of the unit under test and bonded to a ground reference plane for LISNs mounted on top of the ground reference plane. This distance was between the closest points of the LISN 1 and the EUT. All other units of the EUT and associated equipment was at least 0.8 m from the LISN 2.</li> <li>5) In order to find the maximum emission, the relative positions of equipment and all of the interface cables must be changed according to ANSI C63.10: 2013 on conducted measurement.</li> </ol> |              |           |



Unless otherwise agreed in writing, this document is issued by the Company subject to its General Conditions of Service printed overleaf, available on request or accessible at <http://www.sgs.com/en/Terms-and-Conditions.aspx> and, for electronic format documents, subject to Terms and Conditions for Electronic Documents at <http://www.sgs.com/en/Terms-and-Conditions/Terms-e-Documents.aspx>. Attention is drawn to the limitation of liability, indemnification and jurisdiction issues defined therein. Any holder of this document is advised that information contained hereon reflects the Company's findings at the time of its intervention only and within the limits of Client's instructions, if any. The Company's sole responsibility is to its Client and this document does not exonerate parties to a transaction from exercising all their rights and obligations under the transaction documents. This document cannot be reproduced except in full, without prior written approval of the Company. Any unauthorized alteration, forgery or falsification of the content or appearance of this document is unlawful and offenders may be prosecuted to the fullest extent of the law. Unless otherwise stated the results shown in this test report refer only to the sample(s) tested and such sample(s) are retained for 30 days only.

Attention: To check the authenticity of testing/inspection report & certificate, please contact us at telephone: (86-755) 8307 1443, or email: [CN.Doccheck@sgs.com](mailto:CN.Doccheck@sgs.com)

South of No. 6 Plant, No. 1, Runsheng Road, Suzhou Industrial Park, Suzhou Area, China (Jiangsu) Pilot Free Trade Zone 215000  
 中国·苏州·中国(江苏)自由贸易试验区苏州片区苏州工业园区润胜路1号的6号厂房南楼 邮编: 215000

t (86-512) 62992980 www.sgs.com.cn  
 t (86-512) 62992980 sgs.china@sgs.com

|                          |   |
|--------------------------|---|
| <p>Test Setup:</p>       |   |
| <p>Test Mode:</p>        | <p>Transmitting with GFSK modulation.<br/>Charge + Transmitting mode.</p> |
| <p>Instruments Used:</p> | <p>Refer to section 6 for details.</p>                                    |
| <p>Test Results:</p>     | <p>Pass</p>   |



Unless otherwise agreed in writing, this document is issued by the Company subject to its General Conditions of Service printed overleaf, available on request or accessible at <http://www.sgs.com/en/Terms-and-Conditions.aspx> and, for electronic format documents, subject to Terms and Conditions for Electronic Documents at <http://www.sgs.com/en/Terms-and-Conditions/Terms-e-Documents.aspx>. Attention is drawn to the limitation of liability, indemnification and jurisdiction issues defined therein. Any holder of this document is advised that information contained hereon reflects the Company's findings at the time of its intervention only and within the limits of Client's instructions, if any. The Company's sole responsibility is to its Client and this document does not exonerate parties to a transaction from exercising all their rights and obligations under the transaction documents. This document cannot be reproduced except in full, without prior written approval of the Company. Any unauthorized alteration, forgery or falsification of the content or appearance of this document is unlawful and offenders may be prosecuted to the fullest extent of the law. Unless otherwise stated the results shown in this test report refer only to the sample(s) tested and such sample(s) are retained for 30 days only.  
Attention: To check the authenticity of testing/inspection report & certificate, please contact us at telephone: (86-755) 8307 1443, or email: [CN.Doccheck@sgs.com](mailto:CN.Doccheck@sgs.com)

South of No. 6 Plant, No. 1, Runsheng Road, Suzhou Industrial Park, Suzhou Area, China (Jiangsu) Pilot Free Trade Zone 215000  
中国·苏州·中国(江苏)自由贸易试验区苏州片区苏州工业园区润胜路1号的6号厂房南楼 邮编: 215000

t (86-512) 62992980 www.sgs.com.cn  
t (86-512) 62992980 sgs.china@sgs.com

Measurement Data

An initial pre-scan was performed on the live and neutral lines with peak detector.

Quasi-Peak and Average measurement were performed at the frequencies with maximized peak emission were detected.

**BLE 1M:**

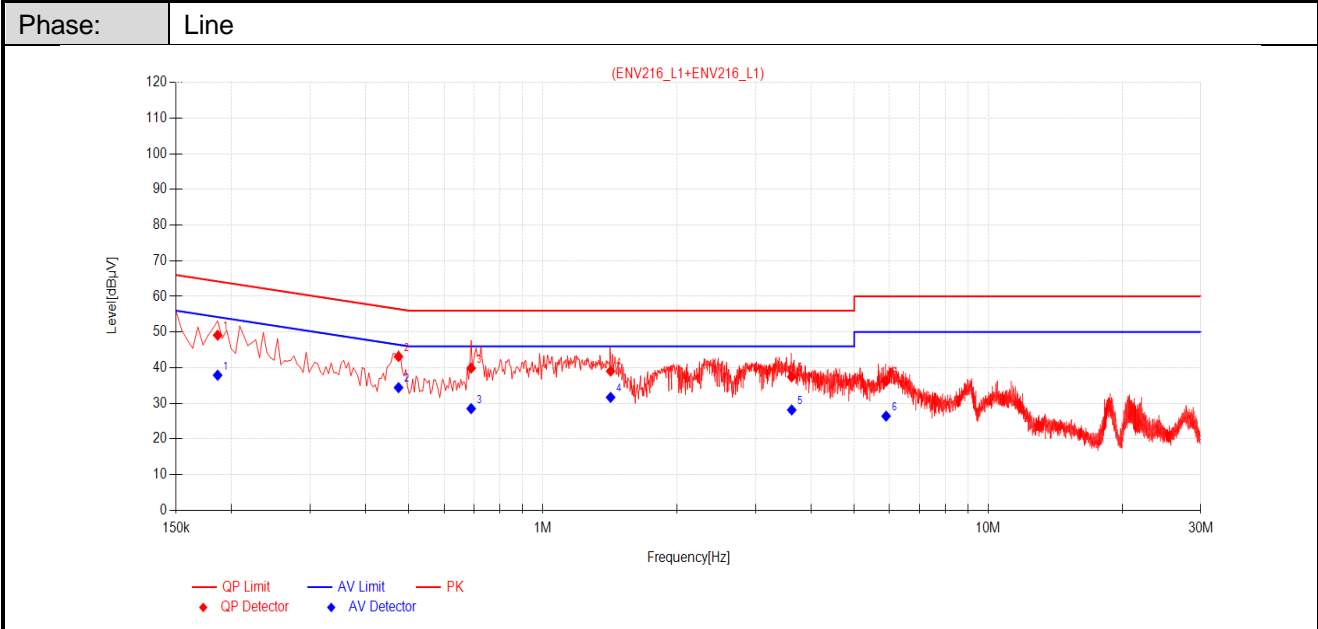

| Final Data List |                 |             |                   |                 |                 |                |                   |                 |                 |                |         |
|-----------------|-----------------|-------------|-------------------|-----------------|-----------------|----------------|-------------------|-----------------|-----------------|----------------|---------|
| NO.             | Frequency [MHz] | Factor [dB] | QP Reading [dBµV] | QP Value [dBµV] | QP Limit [dBµV] | QP Margin [dB] | AV Reading [dBµV] | AV Value [dBµV] | AV Limit [dBµV] | AV Margin [dB] | Verdict |
| 1               | 0.1860          | 10.77       | 38.36             | 49.13           | 64.21           | 15.08          | 27.13             | 37.90           | 54.21           | 16.31          | PASS    |
| 2               | 0.4740          | 10.59       | 32.52             | 43.11           | 56.44           | 13.33          | 23.82             | 34.41           | 46.44           | 12.03          | PASS    |
| 3               | 0.6900          | 10.57       | 29.31             | 39.88           | 56.00           | 16.12          | 17.95             | 28.52           | 46.00           | 17.48          | PASS    |
| 4               | 1.4190          | 10.79       | 28.24             | 39.03           | 56.00           | 16.97          | 20.88             | 31.67           | 46.00           | 14.33          | PASS    |
| 5               | 3.6195          | 10.71       | 26.74             | 37.45           | 56.00           | 18.55          | 17.43             | 28.14           | 46.00           | 17.86          | PASS    |
| 6               | 5.8965          | 10.66       | 25.54             | 36.20           | 60.00           | 23.80          | 15.75             | 26.41           | 50.00           | 23.59          | PASS    |

Remark:

1. The following Quasi-Peak and Average measurements were performed on the EUT:
2. Value = Reading[dBµV] + Factor(Lisn factor[dB] + cable loss[dB]).
3. Margin = Limit[dBµV] – Value[dBµV]



Phase: Neutral

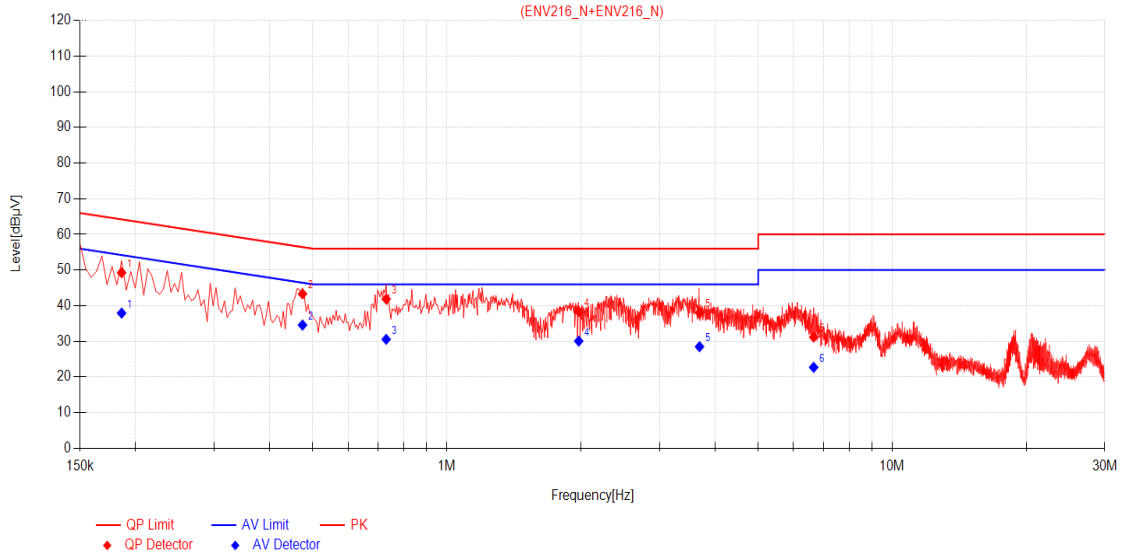

Final Data List

| NO. | Frequency [MHz] | Factor [dB] | QP Reading [dBµV] | QP Value [dBµV] | QP Limit [dBµV] | QP Margin [dB] | AV Reading [dBµV] | AV Value [dBµV] | AV Limit [dBµV] | AV Margin [dB] | Verdict |
|-----|-----------------|-------------|-------------------|-----------------|-----------------|----------------|-------------------|-----------------|-----------------|----------------|---------|
| 1   | 0.1860          | 10.68       | 38.58             | 49.26           | 64.21           | 14.95          | 27.25             | 37.93           | 54.21           | 16.28          | PASS    |
| 2   | 0.4740          | 10.81       | 32.50             | 43.31           | 56.44           | 13.13          | 23.77             | 34.58           | 46.44           | 11.86          | PASS    |
| 3   | 0.7305          | 10.81       | 31.06             | 41.87           | 56.00           | 14.13          | 19.77             | 30.58           | 46.00           | 15.42          | PASS    |
| 4   | 1.9770          | 10.77       | 27.60             | 38.37           | 56.00           | 17.63          | 19.30             | 30.07           | 46.00           | 15.93          | PASS    |
| 5   | 3.6915          | 10.70       | 27.33             | 38.03           | 56.00           | 17.97          | 17.81             | 28.51           | 46.00           | 17.49          | PASS    |
| 6   | 6.6615          | 10.54       | 20.65             | 31.19           | 60.00           | 28.81          | 12.17             | 22.71           | 50.00           | 27.29          | PASS    |

Remark:

- The following Quasi-Peak and Average measurements were performed on the EUT:
- Value = Reading[dBµV] + Factor(Lisn factor[dB] + cable loss[dB]).
- Margin = Limit[dBµV] – Value[dBµV]



Unless otherwise agreed in writing, this document is issued by the Company subject to its General Conditions of Service printed overleaf, available on request or accessible at <http://www.sgs.com/en/Terms-and-Conditions.aspx> and, for electronic format documents, subject to Terms and Conditions for Electronic Documents at <http://www.sgs.com/en/Terms-and-Conditions/Terms-e-Documents.aspx>. Attention is drawn to the limitation of liability, indemnification and jurisdiction issues defined therein. Any holder of this document is advised that information contained hereon reflects the Company's findings at the time of its intervention only and within the limits of Client's instructions, if any. The Company's sole responsibility is to its Client and this document does not exonerate parties to a transaction from exercising all their rights and obligations under the transaction documents. This document cannot be reproduced except in full, without prior written approval of the Company. Any unauthorized alteration, forgery or falsification of the content or appearance of this document is unlawful and offenders may be prosecuted to the fullest extent of the law. Unless otherwise stated the results shown in this test report refer only to the sample(s) tested and such sample(s) are retained for 30 days only.

Attention: To check the authenticity of testing/inspection report & certificate, please contact us at telephone: (86-755) 8307 1443, or email: [CN.Doccheck@sgs.com](mailto:CN.Doccheck@sgs.com)

South of No. 6 Plant, No. 1, Runsheng Road, Suzhou Industrial Park, Suzhou Area, China (Jiangsu) Pilot Free Trade Zone 215000 t (86-512) 62992980 www.sgsgroup.com.cn  
 中国·苏州·中国(江苏)自由贸易试验区苏州片区苏州工业园区润胜路1号的6号厂房南楼 邮编: 215000 t (86-512) 62992980 sgs.china@sgs.com

**BLE 2M:**

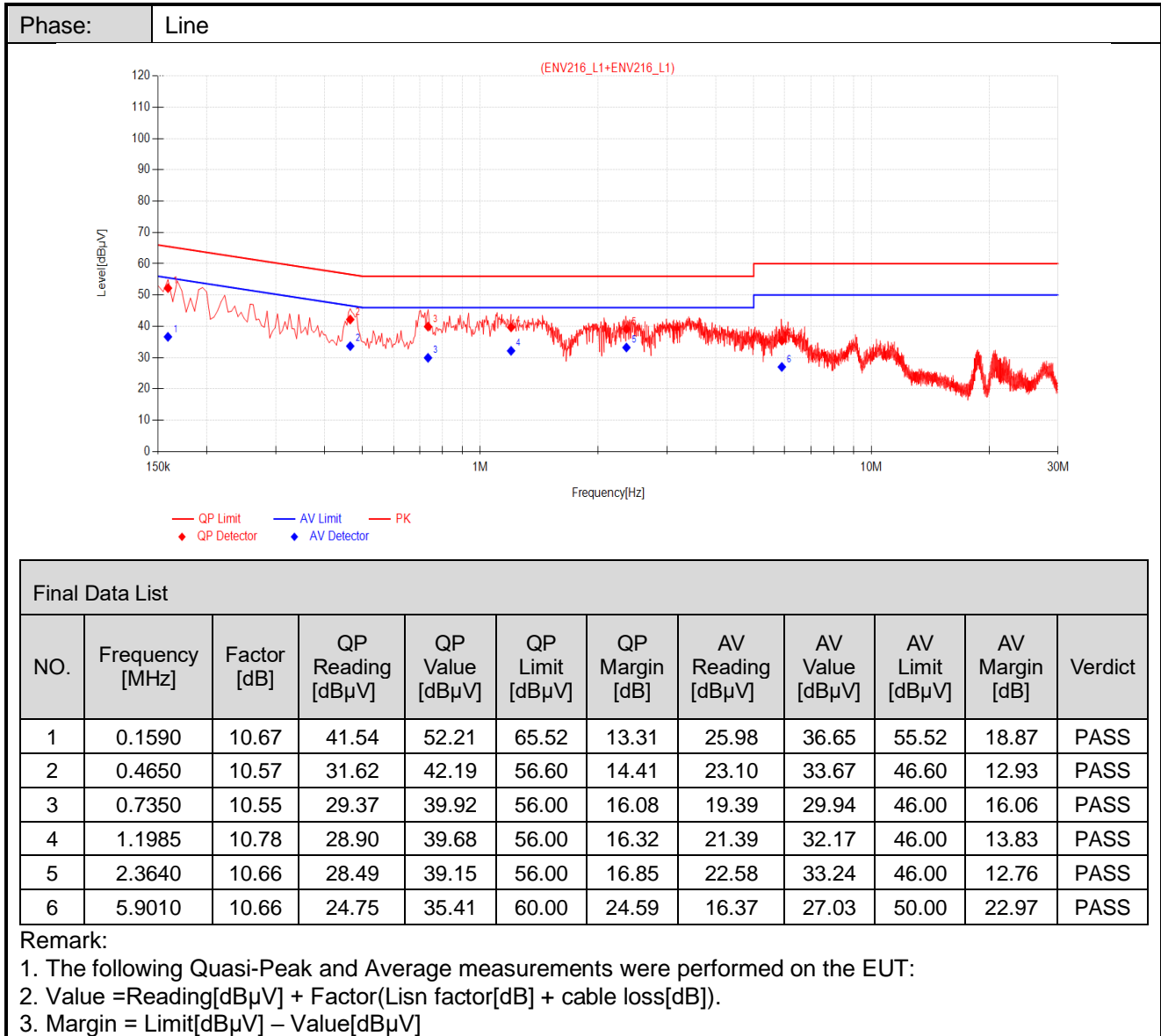

Unless otherwise agreed in writing, this document is issued by the Company subject to its General Conditions of Service printed overleaf, available on request or accessible at <http://www.sgs.com/en/Terms-and-Conditions.aspx> and, for electronic format documents, subject to Terms and Conditions for Electronic Documents at <http://www.sgs.com/en/Terms-and-Conditions/Terms-e-Documents.aspx>. Attention is drawn to the limitation of liability, indemnification and jurisdiction issues defined therein. Any holder of this document is advised that information contained hereon reflects the Company's findings at the time of its intervention only and within the limits of Client's instructions, if any. The Company's sole responsibility is to its Client and this document does not exonerate parties to a transaction from exercising all their rights and obligations under the transaction documents. This document cannot be reproduced except in full, without prior written approval of the Company. Any unauthorized alteration, forgery or falsification of the content or appearance of this document is unlawful and offenders may be prosecuted to the fullest extent of the law. Unless otherwise stated the results shown in this test report refer only to the sample(s) tested and such sample(s) are retained for 30 days only.

Attention: To check the authenticity of testing/inspection report & certificate, please contact us at telephone: (86-755) 8307 1443, or email: [CN.Doccheck@sgs.com](mailto:CN.Doccheck@sgs.com)

South of No. 6 Plant, No. 1, Runsheng Road, Suzhou Industrial Park, Suzhou Area, China (Jiangsu) Pilot Free Trade Zone 215000  
 中国·苏州·中国(江苏)自由贸易试验区苏州片区苏州工业园区润胜路1号的6号厂房南楼 邮编: 215000

t (86-512) 62992980 www.sgs.com.cn  
 t (86-512) 62992980 sgs.china@sgs.com

Phase: Neutral

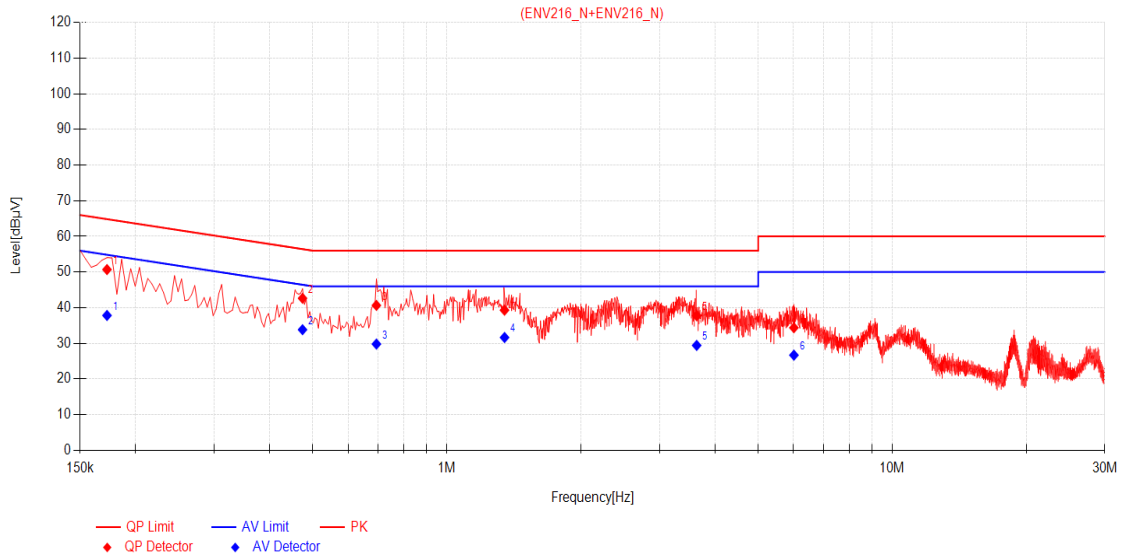

Final Data List

| NO. | Frequency [MHz] | Factor [dB] | QP Reading [dBµV] | QP Value [dBµV] | QP Limit [dBµV] | QP Margin [dB] | AV Reading [dBµV] | AV Value [dBµV] | AV Limit [dBµV] | AV Margin [dB] | Verdict |
|-----|-----------------|-------------|-------------------|-----------------|-----------------|----------------|-------------------|-----------------|-----------------|----------------|---------|
| 1   | 0.1725          | 10.71       | 39.99             | 50.70           | 64.84           | 14.14          | 27.12             | 37.83           | 54.84           | 17.01          | PASS    |
| 2   | 0.4740          | 10.81       | 31.83             | 42.64           | 56.44           | 13.80          | 23.02             | 33.83           | 46.44           | 12.61          | PASS    |
| 3   | 0.6945          | 10.80       | 29.85             | 40.65           | 56.00           | 15.35          | 19.01             | 29.81           | 46.00           | 16.19          | PASS    |
| 4   | 1.3470          | 10.78       | 28.53             | 39.31           | 56.00           | 16.69          | 20.87             | 31.65           | 46.00           | 14.35          | PASS    |
| 5   | 3.6375          | 10.69       | 27.08             | 37.77           | 56.00           | 18.23          | 18.74             | 29.43           | 46.00           | 16.57          | PASS    |
| 6   | 6.0135          | 10.58       | 23.80             | 34.38           | 60.00           | 25.62          | 16.11             | 26.69           | 50.00           | 23.31          | PASS    |

Remark:

1. The following Quasi-Peak and Average measurements were performed on the EUT:
2. Value = Reading[dBµV] + Factor(Lisn factor[dB] + cable loss[dB]).
3. Margin = Limit[dBµV] – Value[dBµV]



Unless otherwise agreed in writing, this document is issued by the Company subject to its General Conditions of Service printed overleaf, available on request or accessible at <http://www.sgs.com/en/Terms-and-Conditions.aspx> and, for electronic format documents, subject to Terms and Conditions for Electronic Documents at <http://www.sgs.com/en/Terms-and-Conditions/Terms-e-Documents.aspx>. Attention is drawn to the limitation of liability, indemnification and jurisdiction issues defined therein. Any holder of this document is advised that information contained hereon reflects the Company's findings at the time of its intervention only and within the limits of Client's instructions, if any. The Company's sole responsibility is to its Client and this document does not exonerate parties to a transaction from exercising all their rights and obligations under the transaction documents. This document cannot be reproduced except in full, without prior written approval of the Company. Any unauthorized alteration, forgery or falsification of the content or appearance of this document is unlawful and offenders may be prosecuted to the fullest extent of the law. Unless otherwise stated the results shown in this test report refer only to the sample(s) tested and such sample(s) are retained for 30 days only.  
**Attention: To check the authenticity of testing/inspection report & certificate, please contact us at telephone: (86-755) 8307 1443, or email: CN.Doccheck@sgs.com**

South of No. 6 Plant, No. 1, Runsheng Road, Suzhou Industrial Park, Suzhou Area, China (Jiangsu) Pilot Free Trade Zone 215000  
 中国·苏州·中国(江苏)自由贸易试验区苏州片区苏州工业园区润胜路1号的6号厂房南楼 邮编: 215000

t (86-512) 62992980 www.sgs.com.cn  
 t (86-512) 62992980 sgs.china@sgs.com

Report No.: SEWM2210000221RG04

Rev.: 01

Page: 16 of 79

### 4.3 Duty Cycle

The detailed test data see: **Appendix**



Unless otherwise agreed in writing, this document is issued by the Company subject to its General Conditions of Service printed overleaf, available on request or accessible at <http://www.sgs.com/en/Terms-and-Conditions.aspx> and, for electronic format documents, subject to Terms and Conditions for Electronic Documents at <http://www.sgs.com/en/Terms-and-Conditions/Terms-e-Document.aspx>. Attention is drawn to the limitation of liability, indemnification and jurisdiction issues defined therein. Any holder of this document is advised that information contained hereon reflects the Company's findings at the time of its intervention only and within the limits of Client's instructions, if any. The Company's sole responsibility is to its Client and this document does not exonerate parties to a transaction from exercising all their rights and obligations under the transaction documents. This document cannot be reproduced except in full, without prior written approval of the Company. Any unauthorized alteration, forgery or falsification of the content or appearance of this document is unlawful and offenders may be prosecuted to the fullest extent of the law. Unless otherwise stated the results shown in this test report refer only to the sample(s) tested and such sample(s) are retained for 30 days only.  
**Attention: To check the authenticity of testing/inspection report & certificate, please contact us at telephone: (86-755) 8307 1443, or email: CN.Doccheck@sgs.com**

South of No. 6 Plant, No. 1, Runsheng Road, Suzhou Industrial Park, Suzhou Area, China (Jiangsu) Pilot Free Trade Zone 215000  
中国·苏州·中国(江苏)自由贸易试验区苏州片区苏州工业园区润胜路1号的6号厂房南楼 邮编: 215000

t (86-512) 62992980 www.sgs.com.cn  
t (86-512) 62992980 sgs.china@sgs.com

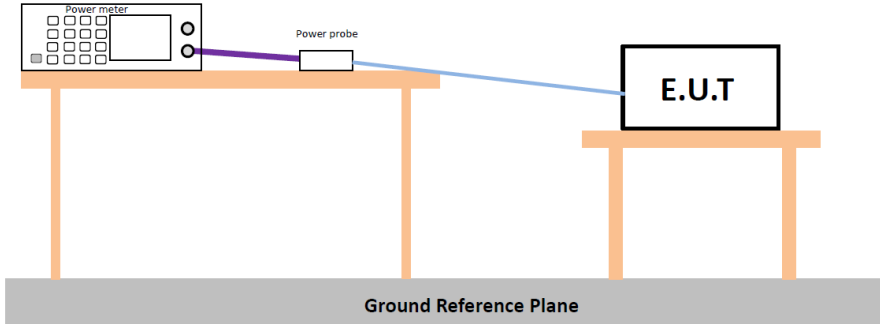

### 4.4 Conducted Output Power

|   |   |
|---|---|
| Test Requirement:                           | 47 CFR Part 15C Section 15.247 (b)(3)   |
| Test Method:                                | ANSI C63.10 :2013 Section11.9.2.3   |
| Test Setup:                                 |  <p>* Test with power meter (Detector function: Peak)</p> |
| Test Instruments:                           | Refer to section 6 for details  |
| Test Mode:                                  | Transmitting with GFSK modulation.  |
| Limit:                                      | 30dBm   |
| Test Results:                               | Pass  |
| The detailed test data see: <b>Appendix</b> |   |



Unless otherwise agreed in writing, this document is issued by the Company subject to its General Conditions of Service printed overleaf, available on request or accessible at <http://www.sgs.com/en/Terms-and-Conditions.aspx> and, for electronic format documents, subject to Terms and Conditions for Electronic Documents at <http://www.sgs.com/en/Terms-and-Conditions/Terms-e-Documents.aspx>. Attention is drawn to the limitation of liability, indemnification and jurisdiction issues defined therein. Any holder of this document is advised that information contained hereon reflects the Company's findings at the time of its intervention only and within the limits of Client's instructions, if any. The Company's sole responsibility is to its Client and this document does not exonerate parties to a transaction from exercising all their rights and obligations under the transaction documents. This document cannot be reproduced except in full, without prior written approval of the Company. Any unauthorized alteration, forgery or falsification of the content or appearance of this document is unlawful and offenders may be prosecuted to the fullest extent of the law. Unless otherwise stated the results shown in this test report refer only to the sample(s) tested and such sample(s) are retained for 30 days only.

Attention: To check the authenticity of testing/inspection report & certificate, please contact us at telephone: (86-755) 8307 1443, or email: [CN.Doccheck@sgs.com](mailto:CN.Doccheck@sgs.com)

South of No. 6 Plant, No. 1, Runsheng Road, Suzhou Industrial Park, Suzhou Area, China (Jiangsu) Pilot Free Trade Zone 215000  
 中国·苏州·中国(江苏)自由贸易试验区苏州片区苏州工业园区润胜路1号的6号厂房南楼 邮编: 215000

t (86-512) 62992980 www.sgs.com.cn  
 t (86-512) 62992980 sgs.china@sgs.com

### 4.5 DTS (6 dB) Bandwidth & 99% Occupied Bandwidth

|   |   |
|---|---|
| Test Requirement:                           | 47 CFR Part 15C Section 15.247 (a)(2)           |
| Test Method:                                | ANSI C63.10: 2013 Section 11.8 Option 2 / 6.9.3 |
| Test Setup:                                 |   |
| Instruments Used:                           | Refer to section 6 for details                  |
| Test Mode:                                  | Transmitting with GFSK modulation.              |
| Limit:                                      | ≥ 500 kHz                                       |
| Test Results:                               | Pass  |
| The detailed test data see: <b>Appendix</b> |   |



Unless otherwise agreed in writing, this document is issued by the Company subject to its General Conditions of Service printed overleaf, available on request or accessible at <http://www.sgs.com/en/Terms-and-Conditions.aspx> and, for electronic format documents, subject to Terms and Conditions for Electronic Documents at <http://www.sgs.com/en/Terms-and-Conditions/Terms-e-Documents.aspx>. Attention is drawn to the limitation of liability, indemnification and jurisdiction issues defined therein. Any holder of this document is advised that information contained hereon reflects the Company's findings at the time of its intervention only and within the limits of Client's instructions, if any. The Company's sole responsibility is to its Client and this document does not exonerate parties to a transaction from exercising all their rights and obligations under the transaction documents. This document cannot be reproduced except in full, without prior written approval of the Company. Any unauthorized alteration, forgery or falsification of the content or appearance of this document is unlawful and offenders may be prosecuted to the fullest extent of the law. Unless otherwise stated the results shown in this test report refer only to the sample(s) tested and such sample(s) are retained for 30 days only.

Attention: To check the authenticity of testing/inspection report & certificate, please contact us at telephone: (86-755) 8307 1443, or email: [CN.Doccheck@sgs.com](mailto:CN.Doccheck@sgs.com)

South of No. 6 Plant, No. 1, Runsheng Road, Suzhou Industrial Park, Suzhou Area, China (Jiangsu) Pilot Free Trade Zone 215000  
 中国·苏州·中国(江苏)自由贸易试验区苏州片区苏州工业园区润胜路1号的6号厂房南楼 邮编: 215000

t (86-512) 62992980 www.sgs.com.cn  
 t (86-512) 62992980 sgs.china@sgs.com

### 4.6 Power Spectral Density

|   |                                    |
|---|------------------------------------|
| Test Requirement:                           | 47 CFR Part 15C Section 15.247 (e) |
| Test Method:                                | ANSI C63.10 :2013 Section 11.10.2  |
| Test Setup:                                 |                                    |
| Test Instruments:                           | Refer to section 6 for details     |
| Test Mode:                                  | Transmitting with GFSK modulation. |
| Limit:                                      | ≤8.00dBm/3kHz                      |
| Test Results:                               | Pass                               |
| The detailed test data see: <b>Appendix</b> |                                    |



Unless otherwise agreed in writing, this document is issued by the Company subject to its General Conditions of Service printed overleaf, available on request or accessible at <http://www.sgs.com/en/Terms-and-Conditions.aspx> and, for electronic format documents, subject to Terms and Conditions for Electronic Documents at <http://www.sgs.com/en/Terms-and-Conditions/Terms-e-Documents.aspx>. Attention is drawn to the limitation of liability, indemnification and jurisdiction issues defined therein. Any holder of this document is advised that information contained hereon reflects the Company's findings at the time of its intervention only and within the limits of Client's instructions, if any. The Company's sole responsibility is to its Client and this document does not exonerate parties to a transaction from exercising all their rights and obligations under the transaction documents. This document cannot be reproduced except in full, without prior written approval of the Company. Any unauthorized alteration, forgery or falsification of the content or appearance of this document is unlawful and offenders may be prosecuted to the fullest extent of the law. Unless otherwise stated the results shown in this test report refer only to the sample(s) tested and such sample(s) are retained for 30 days only.  
 Attention: To check the authenticity of testing/inspection report & certificate, please contact us at telephone: (86-755) 8307 1443, or email: [CN.Doccheck@sgs.com](mailto:CN.Doccheck@sgs.com)

South of No. 6 Plant, No. 1, Runsheng Road, Suzhou Industrial Park, Suzhou Area, China (Jiangsu) Pilot Free Trade Zone 215000 t (86-512) 62992980 www.sgsgroup.com.cn  
 中国·苏州·中国(江苏)自由贸易试验区苏州片区苏州工业园区润胜路1号的6号厂房南楼 邮编: 215000 t (86-512) 62992980 sgs.china@sgs.com

### 4.7 Band-edge for RF Conducted Emissions

|   |   |
|---|---|
| Test Requirement:                           | 47 CFR Part 15C Section 15.247 (d)  |
| Test Method:                                | ANSI C63.10: 2013 Section 11.11   |
| Test Setup:                                 |   |
| Instruments Used:                           | Refer to section 6 for details  |
| Test Mode:                                  | Transmitting with GFSK modulation.  |
| Limit:                                      | In any 100 kHz bandwidth outside the frequency band in which the spread spectrum intentional radiator is operating, the radio frequency power that is produced by the intentional radiator shall be at least 20 dB below that in the 100 kHz bandwidth within the band that contains the highest level of the desired power, based on either an RF conducted or a radiated measurement. |
| Test Results:                               | Pass  |
| The detailed test data see: <b>Appendix</b> |   |



Unless otherwise agreed in writing, this document is issued by the Company subject to its General Conditions of Service printed overleaf, available on request or accessible at <http://www.sgs.com/en/Terms-and-Conditions.aspx> and, for electronic format documents, subject to Terms and Conditions for Electronic Documents at <http://www.sgs.com/en/Terms-and-Conditions/Terms-e-Documents.aspx>. Attention is drawn to the limitation of liability, indemnification and jurisdiction issues defined therein. Any holder of this document is advised that information contained hereon reflects the Company's findings at the time of its intervention only and within the limits of Client's instructions, if any. The Company's sole responsibility is to its Client and this document does not exonerate parties to a transaction from exercising all their rights and obligations under the transaction documents. This document cannot be reproduced except in full, without prior written approval of the Company. Any unauthorized alteration, forgery or falsification of the content or appearance of this document is unlawful and offenders may be prosecuted to the fullest extent of the law. Unless otherwise stated the results shown in this test report refer only to the sample(s) tested and such sample(s) are retained for 30 days only.  
**Attention: To check the authenticity of testing/inspection report & certificate, please contact us at telephone: (86-755) 8307 1443, or email: CN.Doccheck@sgs.com**

South of No. 6 Plant, No. 1, Runsheng Road, Suzhou Industrial Park, Suzhou Area, China (Jiangsu) Pilot Free Trade Zone 215000 t (86-512) 62992980 www.sgs.com.cn  
 中国·苏州·中国(江苏)自由贸易试验区苏州片区苏州工业园区润胜路1号的6号厂房南楼 邮编: 215000 t (86-512) 62992980 sgs.china@sgs.com

### 4.8 RF Conducted Spurious Emissions

|   |   |
|---|---|
| Test Requirement:                           | 47 CFR Part 15C Section 15.247 (d)  |
| Test Method:                                | ANSI C63.10: 2013 Section 11.11   |
| Test Setup:                                 |   |
| Instruments Used:                           | Refer to section 6 for details  |
| Test Mode:                                  | Transmitting with GFSK modulation.  |
| Limit:                                      | In any 100 kHz bandwidth outside the frequency band in which the spread spectrum intentional radiator is operating, the radio frequency power that is produced by the intentional radiator shall be at least 20 dB below that in the 100 kHz bandwidth within the band that contains the highest level of the desired power, based on either an RF conducted or a radiated measurement. |
| Test Results:                               | Pass  |
| The detailed test data see: <b>Appendix</b> |   |



### 4.9 Radiated Spurious Emissions

|   |  |                                  |                |            |                          |
|---|--|----------------------------------|----------------|------------|--------------------------|
| Test Requirement:   | 47 CFR Part 15C Section 15.209 and 15.205        |                                  |                |            |                          |
| Test Method:  | ANSI C63.10 :2013 Section 11.12                  |                                  |                |            |                          |
| Test Site:  | Measurement Distance: 3m (Semi-Anechoic Chamber) |                                  |                |            |                          |
| Test Frequency:   | 9kHz ~ 25GHz                                     |                                  |                |            |                          |
| Limit:  | Frequency  | Field strength (microvolt/meter) | Limit (dBuV/m) | Remark     | Measurement distance (m) |
|   | 0.009MHz-0.490MHz                                | 2400/F(kHz)                      | -              | -          | 300                      |
|   | 0.490MHz-1.705MHz                                | 24000/F(kHz)                     | -              | -          | 30                       |
|   | 1.705MHz-30MHz                                   | 30                               | -              | -          | 30                       |
|   | 30MHz-88MHz                                      | 100                              | 40.0           | Quasi-peak | 3                        |
|   | 88MHz-216MHz                                     | 150                              | 43.5           | Quasi-peak | 3                        |
|   | 216MHz-960MHz                                    | 200                              | 46.0           | Quasi-peak | 3                        |
|   | 960MHz-1GHz                                      | 500                              | 54.0           | Quasi-peak | 3                        |
|   | Above 1GHz                                       | 500                              | 54.0           | Average    | 3                        |
| Remark: 15.35(b), Unless otherwise specified, the limit on peak radio frequency emissions is 20dB above the maximum permitted average emission limit applicable to the equipment under test. This peak limit applies to the total peak emission level radiated by the device. |  |                                  |                |            |                          |

Test Setup:

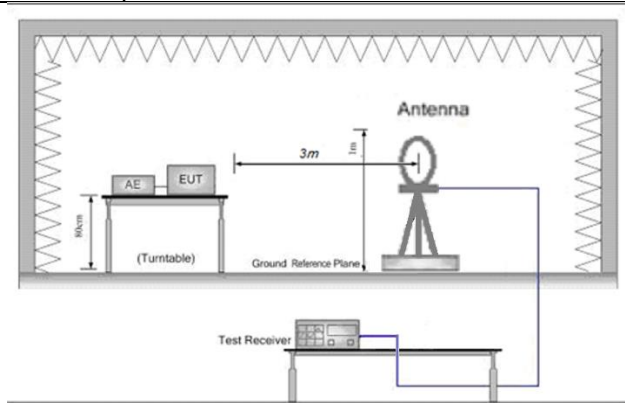

Figure 1. Below 30MHz

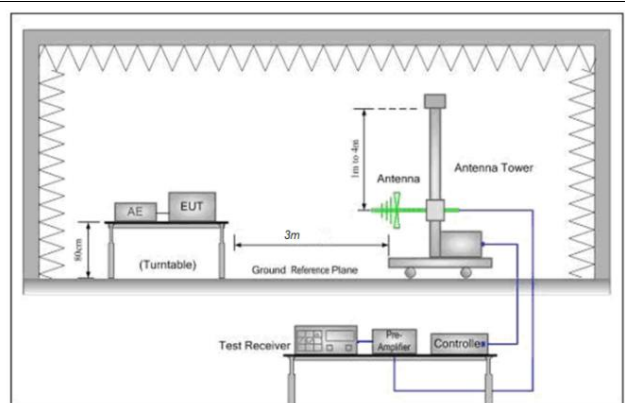

Figure 2. 30MHz to 1GHz



Unless otherwise agreed in writing, this document is issued by the Company subject to its General Conditions of Service printed overleaf, available on request or accessible at <http://www.sgs.com/en/Terms-and-Conditions.aspx> and, for electronic format documents, subject to Terms and Conditions for Electronic Documents at <http://www.sgs.com/en/Terms-and-Conditions/Terms-e-Documents.aspx>. Attention is drawn to the limitation of liability, indemnification and jurisdiction issues defined therein. Any holder of this document is advised that information contained hereon reflects the Company's findings at the time of its intervention only and within the limits of Client's instructions, if any. The Company's sole responsibility is to its Client and this document does not exonerate parties to a transaction from exercising all their rights and obligations under the transaction documents. This document cannot be reproduced except in full, without prior written approval of the Company. Any unauthorized alteration, forgery or falsification of the content or appearance of this document is unlawful and offenders may be prosecuted to the fullest extent of the law. Unless otherwise stated the results shown in this test report refer only to the sample(s) tested and such sample(s) are retained for 30 days only.

Attention: To check the authenticity of testing/inspection report & certificate, please contact us at telephone: (86-755) 8307 1443, or email: [CN.Doccheck@sgs.com](mailto:CN.Doccheck@sgs.com)

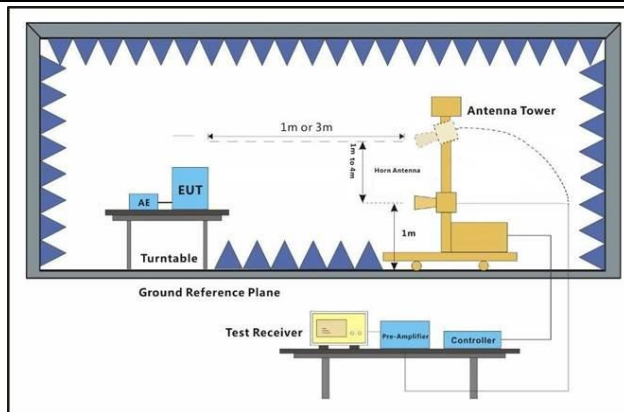

Figure 3. Above 1 GHz

|                            |   |
|----------------------------|---|
| <p>Test Procedure:</p>     | <ol style="list-style-type: none"> <li>For below 1GHz, the EUT was placed on the top of a rotating table 0.8 meters above the ground at a 3 or 10 meter semi-anechoic chamber. The table was rotated 360 degrees to determine the position of the highest radiation.</li> <li>For above 1GHz, the EUT was placed on the top of a rotating table 1.5 meters above the ground at a 3 meter semi-anechoic chamber. The table was rotated 360 degrees to determine the position of the highest radiation (Distance from antenna to EUT is 1m for measurements &gt;18GHz).</li> <li>The EUT was set 3 or 10 meters away from the interference-receiving antenna, which was mounted on the top of a variable-height antenna tower.</li> <li>The antenna height is varied from one meter to four meters above the ground to determine the maximum value of the field strength. Both horizontal and vertical polarizations of the antenna are set to make the measurement.</li> <li>For each suspected emission, the EUT was arranged to its worst case and then the antenna was tuned to heights from 1 meter to 4 meters (for the test frequency of below 30MHz, the antenna was tuned to heights 1 meter) and the rotatable table was turned from 0 degrees to 360 degrees to find the maximum reading.</li> <li>The test-receiver system was set to Peak Detect Function and Specified Bandwidth with Maximum Hold Mode.</li> <li>Test the EUT in the lowest channel, the middle channel, the Highest channel.</li> <li>The radiation measurements are performed in X, Y, Z axis positioning for Transmitting mode, And found the X axis positioning which it is worse case.</li> <li>Repeat above procedures until all frequencies measured was complete.</li> <li>The low frequency, which started from 9 kHz to 30MHz, was pre-scanned and the result which was 20dB lower than the limit line was not reported</li> <li>The disturbance above 18GHz was very low, and the harmonics were the highest point could be found when testing, so only the harmonics had been displayed.</li> <li>At a measurement distance of 1 meter the limit line was increased by <math>20 \cdot \log(3/1) = 9.54 \text{ dB}</math>.</li> </ol> |
| <p>Test Configuration:</p> | <p>Measurements Below 1000MHz</p> <ul style="list-style-type: none"> <li>RBW = 120 kHz</li> <li>VBW = 300 kHz</li> <li>Detector = Peak</li> <li>Trace mode = max hold</li> </ul>  |



|   |   |
|---|---|
|   | <p>Peak Measurements Above 1000 MHz</p> <ul style="list-style-type: none"> <li>• RBW = 1 MHz</li> <li>• VBW ≥ 3 MHz</li> <li>• Detector = Peak</li> <li>• Sweep time = auto</li> <li>• Trace mode = max hold</li> </ul> <p>Average Measurements Above 1000MHz</p> <ul style="list-style-type: none"> <li>• RBW = 1 MHz</li> <li>• VBW ≥ [3 *RBW]</li> <li>• Detector = RMS (power averaging), if span / (# of points in sweep) ≤ (RBW / 2). Satisfying this condition may require increasing the number of points in the sweep or reducing the span. If this condition cannot be satisfied, then the detector mode shall be set to peak.</li> <li>• Sweep time = auto</li> <li>• Perform a trace average of at least 100 traces.</li> </ul> |
| Exploratory Test Mode:                      | <p>Transmitting with GFSK modulation.<br/>Charge + Transmitting mode.</p>   |
| Final Test Mode:                            | <p>Transmitting with GFSK modulation.<br/>Pretest the EUT at Charge + Transmitting mode,<br/>For below 1GHz part, through pre-scan, the worst case is the lowest channel. Only the worst case is recorded in the report.</p>  |
| Instruments Used:                           | Refer to section 6 for details  |
| Test Results:                               | Pass  |
| The detailed test data see: <b>Appendix</b> |   |



Unless otherwise agreed in writing, this document is issued by the Company subject to its General Conditions of Service printed overleaf, available on request or accessible at <http://www.sgs.com/en/Terms-and-Conditions.aspx> and, for electronic format documents, subject to Terms and Conditions for Electronic Documents at <http://www.sgs.com/en/Terms-and-Conditions/Terms-e-Documents.aspx>. Attention is drawn to the limitation of liability, indemnification and jurisdiction issues defined therein. Any holder of this document is advised that information contained hereon reflects the Company's findings at the time of its intervention only and within the limits of Client's instructions, if any. The Company's sole responsibility is to its Client and this document does not exonerate parties to a transaction from exercising all their rights and obligations under the transaction documents. This document cannot be reproduced except in full, without prior written approval of the Company. Any unauthorized alteration, forgery or falsification of the content or appearance of this document is unlawful and offenders may be prosecuted to the fullest extent of the law. Unless otherwise stated the results shown in this test report refer only to the sample(s) tested and such sample(s) are retained for 30 days only.  
Attention: To check the authenticity of testing / inspection report & certificate, please contact us at telephone: (86-755) 8307 1443, or email: [CN.Doccheck@sgs.com](mailto:CN.Doccheck@sgs.com)

South of No. 6 Plant, No. 1, Runsheng Road, Suzhou Industrial Park, Suzhou Area, China (Jiangsu) Pilot Free Trade Zone 215000  
中国·苏州·中国(江苏)自由贸易试验区苏州片区苏州工业园区润胜路1号的6号厂房南楼 邮编: 215000

t (86-512) 62992980 www.sgs.com.cn  
t (86-512) 62992980 sgs.china@sgs.com



### 4.10 Restricted bands around fundamental frequency

|                   |  |                |               |
|-------------------|--|----------------|---------------|
| Test Requirement: | 47 CFR Part 15C Section 15.209 and 15.205        |                |               |
| Test Method:      | ANSI C63.10: 2013 Section 11.12                  |                |               |
| Test Site:        | Measurement Distance: 3m (Semi-Anechoic Chamber) |                |               |
| Limit:            | Frequency  | Limit (dBuV/m) | Remark        |
|                   | 30MHz-88MHz                                      | 40.0           | Quasi-peak    |
|                   | 88MHz-216MHz                                     | 43.5           | Quasi-peak    |
|                   | 216MHz-960MHz                                    | 46.0           | Quasi-peak    |
|                   | 960MHz-1GHz                                      | 54.0           | Quasi-peak    |
|                   | Above 1GHz                                       | 54.0           | Average Value |
|                   |  | 74.0           | Peak Value    |

Test Setup:

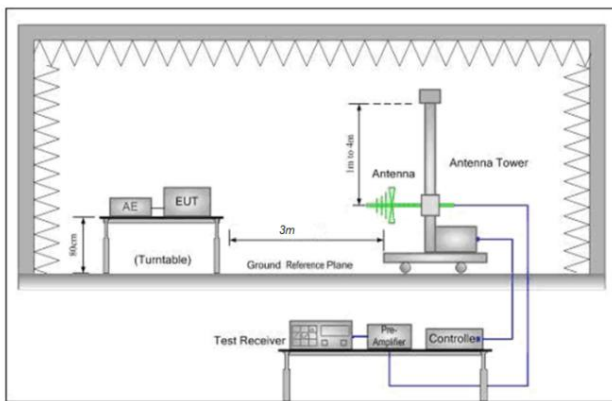

Figure 1. 30MHz to 1GHz

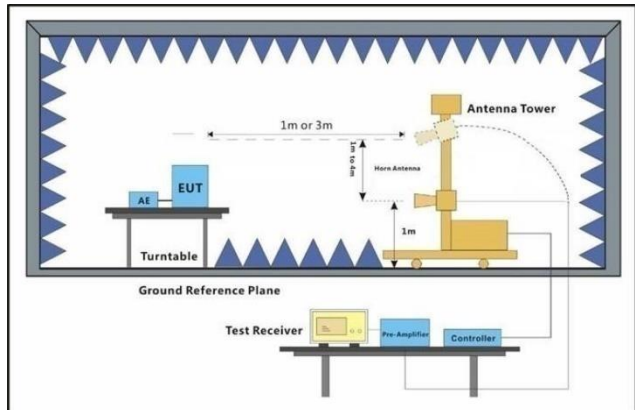

Figure 2. Above 1 GHz

Test Procedure:

- For below 1GHz, the EUT was placed on the top of a rotating table 0.8 meters above the ground at a 3 or 10 meter semi-anechoic chamber. The table was rotated 360 degrees to determine the position of the highest radiation.
- For above 1GHz, the EUT was placed on the top of a rotating table 1.5 meters above the ground at a 3 meter semi-anechoic chamber. The table was rotated 360 degrees to determine the position of the highest radiation.
- The EUT was set 3 or 10 meters away from the interference-receiving antenna, which was mounted on the top of a variable-height antenna tower.
- The antenna height is varied from one meter to four meters above the ground to determine the maximum value of the field strength. Both horizontal and vertical polarizations of the antenna are set to make the measurement.
- For each suspected emission, the EUT was arranged to its worst case and then the antenna was tuned to heights from 1 meter to 4 meters and the rotatable table was turned from 0 degrees to 360 degrees to find the maximum reading.
- The test-receiver system was set to Peak Detect Function and Specified Bandwidth with Maximum Hold Mode.
- Place a marker at the end of the restricted band closest to the transmit



Unless otherwise agreed in writing, this document is issued by the Company subject to its General Conditions of Service printed overleaf, available on request or accessible at <http://www.sgs.com/en/Terms-and-Conditions.aspx> and, for electronic format documents, subject to Terms and Conditions for Electronic Documents at <http://www.sgs.com/en/Terms-and-Conditions/Terms-e-Documents.aspx>. Attention is drawn to the limitation of liability, indemnification and jurisdiction issues defined therein. Any holder of this document is advised that information contained hereon reflects the Company's findings at the time of its intervention only and within the limits of Client's instructions, if any. The Company's sole responsibility is to its Client and this document does not exonerate parties to a transaction from exercising all their rights and obligations under the transaction documents. This document cannot be reproduced except in full, without prior written approval of the Company. Any unauthorized alteration, forgery or falsification of the content or appearance of this document is unlawful and offenders may be prosecuted to the fullest extent of the law. Unless otherwise stated the results shown in this test report refer only to the sample(s) tested and such sample(s) are retained for 30 days only.

Attention: To check the authenticity of testing/inspection report & certificate, please contact us at telephone: (86-755) 8307 1443, or email: [CN.Doccheck@sgs.com](mailto:CN.Doccheck@sgs.com)

South of No. 6 Plant, No. 1, Runsheng Road, Suzhou Industrial Park, Suzhou Area, China (Jiangsu) Pilot Free Trade Zone 215000  
 中国·苏州·中国(江苏)自由贸易试验区苏州片区苏州工业园区润胜路1号的6号厂房南面 邮编: 215000

t (86-512) 62992980 www.sgs.com.cn  
 t (86-512) 62992980 sgs.china@sgs.com

|   |  |
|---|--|
|   | <p>frequency to show compliance. Also measure any emissions in the restricted bands. Save the spectrum analyzer plot. Repeat for each power and modulation for lowest and highest channel</p> <p>h. Test the EUT in the lowest channel , the Highest channel</p> <p>i. The radiation measurements are performed in X, Y, Z axis positioning for Transmitting mode,And found the X axis positioning which it is worse case.</p> <p>j. Repeat above procedures until all frequencies measured was complete.</p>  |
| Test Configuration:                         | <p>Measurements Below 1000MHz</p> <ul style="list-style-type: none"> <li>• RBW = 120 kHz</li> <li>• VBW = 300 kHz</li> <li>• Detector = Peak</li> <li>• Trace mode = max hold</li> </ul> <p>Peak Measurements Above 1000 MHz</p> <ul style="list-style-type: none"> <li>• RBW = 1 MHz</li> <li>• VBW ≥ 3 MHz</li> <li>• Detector = Peak</li> <li>• Sweep time = auto</li> <li>• Trace mode = max hold</li> </ul> <p>Average Measurements Above 1000MHz</p> <ul style="list-style-type: none"> <li>• RBW = 1 MHz</li> <li>• VBW ≥ [3 *RBW]</li> <li>• Detector = RMS (power averaging), if span / (# of points in sweep) ≤ (RBW / 2). Satisfying this condition may require increasing the number of points in the sweep or reducing the span. If this condition cannot be satisfied, then the detector mode shall be set to peak.</li> <li>• Sweep time = auto</li> <li>• Perform a trace average of at least 100 traces.</li> </ul> |
| Exploratory Test Mode:                      | <p>Transmitting with GFSK modulation.<br/>Charge + Transmitting mode.</p>  |
| Final Test Mode:                            | <p>Transmitting with GFSK modulation.<br/>Pretest the EUT at Charge + Transmitting mode.<br/>Only the worst case is recorded in the report.</p>  |
| Instruments Used:                           | Refer to section 6 for details   |
| Test Results:                               | Pass   |
| The detailed test data see: <b>Appendix</b> |  |



Unless otherwise agreed in writing, this document is issued by the Company subject to its General Conditions of Service printed overleaf, available on request or accessible at <http://www.sgs.com/en/Terms-and-Conditions.aspx> and, for electronic format documents, subject to Terms and Conditions for Electronic Documents at <http://www.sgs.com/en/Terms-and-Conditions/Terms-e-Documents.aspx>. Attention is drawn to the limitation of liability, indemnification and jurisdiction issues defined therein. Any holder of this document is advised that information contained hereon reflects the Company's findings at the time of its intervention only and within the limits of Client's instructions, if any. The Company's sole responsibility is to its Client and this document does not exonerate parties to a transaction from exercising all their rights and obligations under the transaction documents. This document cannot be reproduced except in full, without prior written approval of the Company. Any unauthorized alteration, forgery or falsification of the content or appearance of this document is unlawful and offenders may be prosecuted to the fullest extent of the law. Unless otherwise stated the results shown in this test report refer only to the sample(s) tested and such sample(s) are retained for 30 days only.

Attention: To check the authenticity of testing/inspection report & certificate, please contact us at telephone: (86-755) 8307 1443, or email: [CN.Doccheck@sgs.com](mailto:CN.Doccheck@sgs.com)

South of No. 6 Plant, No. 1, Runsheng Road, Suzhou Industrial Park, Suzhou Area, China (Jiangsu) Pilot Free Trade Zone 215000 t (86-512) 62992980 www.sgs.com.cn  
 中国·苏州·中国(江苏)自由贸易试验区苏州片区苏州工业园区润胜路1号的6号厂房南楼 邮编: 215000 t (86-512) 62992980 sgs.china@sgs.com

### 5 Measurement Uncertainty (95% confidence levels, k=2)

| No. | Item                          | Measurement Uncertainty    |
|-----|-------------------------------|----------------------------|
| 1   | Total RF power, conducted     | ±0.54dB                    |
| 2   | RF power density, conducted   | ±1.03dB                    |
| 3   | Spurious emissions, conducted | ±0.54dB                    |
| 4   | Radio Frequency               | ±1.0 %                     |
| 5   | Duty Cycle                    | ±0.37%                     |
| 6   | Occupied Bandwidth            | ±1.0 %                     |
| 7   | Conduction Emission           | ± 2.90dB (150kHz to 30MHz) |
| 8   | Radiated Emission             | ± 3.13dB (9k -30MHz)       |
|     |                               | ± 4.80dB (30M -1GHz)       |
|     |                               | ± 4.80dB (1GHz to 18GHz)   |
|     |                               | ± 4.80dB (Above 18GHz)     |

**Remark:**

The  $U_{lab}$  (lab Uncertainty) is less than  $U_{CISPR/ETSI}$  (CISPR/ETSI Uncertainty), so the test results  
 – compliance is deemed to occur if no measured disturbance level exceeds the disturbance limit;  
 – non-compliance is deemed to occur if any measured disturbance level exceeds the disturbance limit.



Unless otherwise agreed in writing, this document is issued by the Company subject to its General Conditions of Service printed overleaf, available on request or accessible at <http://www.sgs.com/en/Terms-and-Conditions.aspx> and, for electronic format documents, subject to Terms and Conditions for Electronic Documents at <http://www.sgs.com/en/Terms-and-Conditions/Terms-e-Documents.aspx>. Attention is drawn to the limitation of liability, indemnification and jurisdiction issues defined therein. Any holder of this document is advised that information contained hereon reflects the Company's findings at the time of its intervention only and within the limits of Client's instructions, if any. The Company's sole responsibility is to its Client and this document does not exonerate parties to a transaction from exercising all their rights and obligations under the transaction documents. This document cannot be reproduced except in full, without prior written approval of the Company. Any unauthorized alteration, forgery or falsification of the content or appearance of this document is unlawful and offenders may be prosecuted to the fullest extent of the law. Unless otherwise stated the results shown in this test report refer only to the sample(s) tested and such sample(s) are retained for 30 days only.  
**Attention: To check the authenticity of testing/inspection report & certificate, please contact us at telephone: (86-755) 8307 1443, or email: CN.Doccheck@sgs.com**

South of No. 6 Plant, No. 1, Runsheng Road, Suzhou Industrial Park, Suzhou Area, China (Jiangsu) Pilot Free Trade Zone 215000  
 中国·苏州·中国(江苏)自由贸易试验区苏州片区苏州工业园区润胜路1号的6号厂房南楼 邮编: 215000

t (86-512) 62992980 www.sgs.com.cn  
 t (86-512) 62992980 sgs.china@sgs.com

## 6 Equipment List

| RF Test Equipment                   |                |                              |               |                       |                           |
|-------------------------------------|----------------|------------------------------|---------------|-----------------------|---------------------------|
| Equipment                           | Manufacturer   | Model No.                    | Inventory No. | Cal Date (yyyy/mm/dd) | Cal Due Date (yyyy/mm/dd) |
| Shielding Room                      | Brilliant-emc  | N/A                          | SUWI-04-01-06 | 2021/05/08            | 2024/05/07                |
| Temperature and humidity meter      | MingGao        | TH101B                       | SUWI-01-01-07 | 2022/02/16            | 2023/02/15                |
| Signal Analyzer                     | ROHDE &SCHWARZ | FSV3030                      | SUWI-01-02-02 | 2022/05/17            | 2023/05/16                |
| Measurement Software                | Tonscend       | JS1120-3 Test System V3.1.55 | SUWI-02-09-09 | NCR                   | NCR                       |
| DC Power Supply                     | HYELEC         | HY3005B                      | SUWI-01-18-01 | 2022/02/15            | 2023/02/14                |
| Signal Analyzer                     | ROHDE &SCHWARZ | FSW43                        | SUWI-01-02-04 | 2022/05/28            | 2023/05/27                |
| Power meter                         | Anritsu        | ML2495A                      | SUWI-01-31-01 | 2021/12/04            | 2022/12/03                |
|                                     |                |                              |               | 2022/11/23            | 2023/11/22                |
| Pulse power sensor                  | Anritsu        | MA2411B                      | SUWI-01-32-01 | 2021/12/04            | 2022/12/03                |
|                                     |                |                              |               | 2022/11/23            | 2023/11/22                |
| MXG Vector signal genitor           | KEYSIGHT       | N5182B                       | SUWI-01-38-01 | 2022/02/14            | 2023/02/13                |
| Temperature Chamber                 | ESPEC          | SU-242                       | SUWI-01-13-01 | 2022/02/15            | 2023/02/14                |
| Wideband Radio Communication Tester | ROHDE &SCHWARZ | CMW500                       | SUWI-01-16-05 | 2022/02/14            | 2023/02/13                |

| CE Test System                 |               |                  |               |                       |                           |
|--------------------------------|---------------|------------------|---------------|-----------------------|---------------------------|
| Equipment                      | Manufacturer  | Model No.        | Inventory No. | Cal Date (yyyy/mm/dd) | Cal Due Date (yyyy/mm/dd) |
| Shielding Room                 | Brilliant-emc | N/A              | SUWI-04-03-01 | 2021/05/08            | 2024/05/07                |
| Artificial network             | ROHDE&SCHWARZ | ENV216           | SUWI-01-19-01 | 2022/02/19            | 2023/02/18                |
| Artificial network             | ROHDE&SCHWARZ | ENV216           | SUWI-01-19-02 | 2022/02/19            | 2023/02/18                |
| Measurement Software           | Tonscend      | JS32-CE V4.0.0.2 | SUWI-02-09-05 | NCR                   | NCR                       |
| Test receiver                  | ROHDE&SCHWARZ | ESR7             | SUWI-01-10-01 | 2022/02/19            | 2023/02/18                |
| Temperature and humidity meter | MingGao       | TH101B           | SUWI-01-01-06 | 2022/02/16            | 2023/02/15                |



Unless otherwise agreed in writing, this document is issued by the Company subject to its General Conditions of Service printed overleaf, available on request or accessible at <http://www.sgs.com/en/Terms-and-Conditions.aspx> and, for electronic format documents, subject to Terms and Conditions for Electronic Documents at <http://www.sgs.com/en/Terms-and-Conditions/Terms-e-Documents.aspx>. Attention is drawn to the limitation of liability, indemnification and jurisdiction issues defined therein. Any holder of this document is advised that information contained hereon reflects the Company's findings at the time of its intervention only and within the limits of Client's instructions, if any. The Company's sole responsibility is to its Client and this document does not exonerate parties to a transaction from exercising all their rights and obligations under the transaction documents. This document cannot be reproduced except in full, without prior written approval of the Company. Any unauthorized alteration, forgery or falsification of the content or appearance of this document is unlawful and offenders may be prosecuted to the fullest extent of the law. Unless otherwise stated the results shown in this test report refer only to the sample(s) tested and such sample(s) are retained for 30 days only.

Attention: To check the authenticity of testing/inspection report & certificate, please contact us at telephone: (86-755) 8307 1443, or email: [CN.Doccheck@sgs.com](mailto:CN.Doccheck@sgs.com)

South of No. 6 Plant, No. 1, Runsheng Road, Suzhou Industrial Park, Suzhou Area, China (Jiangsu) Pilot Free Trade Zone 215000  
 中国·苏州·中国(江苏)自由贸易试验区苏州片区苏州工业园区润胜路1号的6号厂房南楼 邮编: 215000

t (86-512) 62992980 www.sgs.com.cn  
 t (86-512) 62992980 sgs.china@sgs.com

| RSE Test System                |                            |                  |               |                        |                           |
|--------------------------------|----------------------------|------------------|---------------|------------------------|---------------------------|
| Test Equipment                 | Manufacturer               | Model No.        | Inventory No. | Cal. date (yyyy/mm/dd) | Cal.Due date (yyyy/mm/dd) |
| Semi-Anechoic Chamber          | Brilliant-emc              | N/A              | SUWI-04-02-02 | 2021/11/25             | 2024/11/24                |
| Temperature and humidity meter | MingGao                    | TH101B           | SUWI-01-01-15 | 2022/02/16             | 2023/02/15                |
| Signal Analyzer                | ROHDE&SCHWARZ              | FSW43            | SUWI-01-02-04 | 2022/05/28             | 2023/05/27                |
| Signal Analyzer                | KEYSIGHT                   | N9020A           | SUWI-01-02-06 | 2021/12/04             | 2022/12/03                |
|                                |                            |                  |               | 2022/11/23             | 2023/11/22                |
| Test receiver                  | ROHDE&SCHWARZ              | ESR7             | SUWI-01-10-01 | 2022/02/19             | 2023/02/18                |
| DC Power Supply                | HYELEC                     | HY3005B          | SUWI-01-18-01 | 2022/02/15             | 2023/02/14                |
| Receiving antenna              | SCHWRZBECK MESS-ELEKTRONIK | VULB 9163        | SUWI-01-11-04 | 2021/12/05             | 2023/12/04                |
| Receiving antenna              | SCHWRZBECK MESS-ELEKTRONIK | BBHA 9120D       | SUWI-01-11-05 | 2021/12/05             | 2023/12/04                |
| Receiving antenna              | SCHWRZBECK MESS-ELEKTRONIK | BBHA 9170        | SUWI-01-11-03 | 2021/05/14             | 2023/05/13                |
| Active Loop Antenna            | SCHWRZBECK MESS-ELEKTRONIK | FMZB 1519B       | SUWI-01-21-01 | 2021/06/10             | 2023/06/09                |
| Amplifier                      | Tonscend                   | TAP9K3G32        | SUWI-01-14-06 | 2021/12/04             | 2022/12/03                |
|                                |                            |                  |               | 2022/11/23             | 2023/11/22                |
| Amplifier                      | Tonscend                   | TAP01018050      | SUWI-01-14-04 | 2021/12/04             | 2022/12/03                |
|                                |                            |                  |               | 2022/11/23             | 2023/11/22                |
| Amplifier                      | Tonscend                   | TAP30M7G30       | SUWI-01-14-05 | 2021/12/04             | 2022/12/03                |
|                                |                            |                  |               | 2022/11/23             | 2023/11/22                |
| Measurement Software           | Tonscend                   | JS32-RE V4.0.0.0 | SUWI-02-09-04 | NCR                    | NCR                       |



Unless otherwise agreed in writing, this document is issued by the Company subject to its General Conditions of Service printed overleaf, available on request or accessible at <http://www.sgs.com/en/Terms-and-Conditions.aspx> and, for electronic format documents, subject to Terms and Conditions for Electronic Documents at <http://www.sgs.com/en/Terms-and-Conditions/Terms-e-Documents.aspx>. Attention is drawn to the limitation of liability, indemnification and jurisdiction issues defined therein. Any holder of this document is advised that information contained hereon reflects the Company's findings at the time of its intervention only and within the limits of Client's instructions, if any. The Company's sole responsibility is to its Client and this document does not exonerate parties to a transaction from exercising all their rights and obligations under the transaction documents. This document cannot be reproduced except in full, without prior written approval of the Company. Any unauthorized alteration, forgery or falsification of the content or appearance of this document is unlawful and offenders may be prosecuted to the fullest extent of the law. Unless otherwise stated the results shown in this test report refer only to the sample(s) tested and such sample(s) are retained for 30 days only.

Attention: To check the authenticity of testing/inspection report & certificate, please contact us at telephone: (86-755) 8307 1443, or email: [CN.Doccheck@sgs.com](mailto:CN.Doccheck@sgs.com)

South of No. 6 Plant, No. 1, Runsheng Road, Suzhou Industrial Park, Suzhou Area, China (Jiangsu) Pilot Free Trade Zone 215000 t (86-512) 62992980 www.sgsgroup.com.cn  
 中国·苏州·中国(江苏)自由贸易试验区苏州片区苏州工业园区润胜路1号的6号厂房南楼 邮编: 215000 t (86-512) 62992980 sgs.china@sgs.com

Report No.: SEWM2210000221RG04

Rev.: 01

Page: 30 of 79

## 7 Photographs - Setup Photos

Refer to Appendix A.2 WLAN Setup Photos.



Unless otherwise agreed in writing, this document is issued by the Company subject to its General Conditions of Service printed overleaf, available on request or accessible at <http://www.sgs.com/en/Terms-and-Conditions.aspx> and, for electronic format documents, subject to Terms and Conditions for Electronic Documents at <http://www.sgs.com/en/Terms-and-Conditions/Terms-e-Documents.aspx>. Attention is drawn to the limitation of liability, indemnification and jurisdiction issues defined therein. Any holder of this document is advised that information contained hereon reflects the Company's findings at the time of its intervention only and within the limits of Client's instructions, if any. The Company's sole responsibility is to its Client and this document does not exonerate parties to a transaction from exercising all their rights and obligations under the transaction documents. This document cannot be reproduced except in full, without prior written approval of the Company. Any unauthorized alteration, forgery or falsification of the content or appearance of this document is unlawful and offenders may be prosecuted to the fullest extent of the law. Unless otherwise stated the results shown in this test report refer only to the sample(s) tested and such sample(s) are retained for 30 days only.  
**Attention: To check the authenticity of testing/inspection report & certificate, please contact us at telephone: (86-755) 8307 1443, or email: [CN.Doccheck@sgs.com](mailto:CN.Doccheck@sgs.com)**

South of No. 6 Plant, No. 1, Runsheng Road, Suzhou Industrial Park, Suzhou Area, China (Jiangsu) Pilot Free Trade Zone 215000  
中国·苏州·中国(江苏)自由贸易试验区苏州片区苏州工业园区润胜路1号的6号厂房南楼 邮编: 215000

t (86-512) 62992980 www.sgs.com.cn  
t (86-512) 62992980 sgs.china@sgs.com

Report No.: SEWM2210000221RG04

Rev.: 01

Page: 31 of 79

# Appendix



Unless otherwise agreed in writing, this document is issued by the Company subject to its General Conditions of Service printed overleaf, available on request or accessible at <http://www.sgs.com/en/Terms-and-Conditions.aspx> and, for electronic format documents, subject to Terms and Conditions for Electronic Documents at <http://www.sgs.com/en/Terms-and-Conditions/Terms-e-Document.aspx>. Attention is drawn to the limitation of liability, indemnification and jurisdiction issues defined therein. Any holder of this document is advised that information contained hereon reflects the Company's findings at the time of its intervention only and within the limits of Client's instructions, if any. The Company's sole responsibility is to its Client and this document does not exonerate parties to a transaction from exercising all their rights and obligations under the transaction documents. This document cannot be reproduced except in full, without prior written approval of the Company. Any unauthorized alteration, forgery or falsification of the content or appearance of this document is unlawful and offenders may be prosecuted to the fullest extent of the law. Unless otherwise stated the results shown in this test report refer only to the sample(s) tested and such sample(s) are retained for 30 days only.  
**Attention: To check the authenticity of testing/inspection report & certificate, please contact us at telephone: (86-755) 8307 1443, or email: [CN.Doccheck@sgs.com](mailto:CN.Doccheck@sgs.com)**

South of No. 6 Plant, No. 1, Runsheng Road, Suzhou Industrial Park, Suzhou Area, China (Jiangsu) Pilot Free Trade Zone 215000  
中国·苏州·中国(江苏)自由贸易试验区苏州片区苏州工业园区润胜路1号的6号厂房南楼 邮编: 215000

t (86-512) 62992980 www.sgs.com.cn  
t (86-512) 62992980 sgs.china@sgs.com

Report No.: SEWM2210000221RG04

Rev.: 01

Page: 32 of 79

### DTS Bandwidth Test Result

| TestMode | Antenna | Frequency[MHz] | DTS BW [MHz] | FL[MHz] | FH[MHz] | Limit[MHz] | Verdict |
|----------|---------|----------------|--------------|---------|---------|------------|---------|
| BLE_1M   | Ant1    | 2402           | 0.71         | 2401.64 | 2402.35 | ≥0.5       | PASS    |
|          |         | 2440           | 0.70         | 2439.65 | 2440.35 | ≥0.5       | PASS    |
|          |         | 2480           | 0.70         | 2479.65 | 2480.35 | ≥0.5       | PASS    |
| BLE_2M   | Ant1    | 2402           | 1.19         | 2401.40 | 2402.59 | ≥0.5       | PASS    |
|          |         | 2440           | 1.18         | 2439.41 | 2440.59 | ≥0.5       | PASS    |
|          |         | 2480           | 1.18         | 2479.41 | 2480.59 | ≥0.5       | PASS    |



Unless otherwise agreed in writing, this document is issued by the Company subject to its General Conditions of Service printed overleaf, available on request or accessible at <http://www.sgs.com/en/Terms-and-Conditions.aspx> and, for electronic format documents, subject to Terms and Conditions for Electronic Documents at <http://www.sgs.com/en/Terms-and-Conditions/Terms-e-Document.aspx>. Attention is drawn to the limitation of liability, indemnification and jurisdiction issues defined therein. Any holder of this document is advised that information contained hereon reflects the Company's findings at the time of its intervention only and within the limits of Client's instructions, if any. The Company's sole responsibility is to its Client and this document does not exonerate parties to a transaction from exercising all their rights and obligations under the transaction documents. This document cannot be reproduced except in full, without prior written approval of the Company. Any unauthorized alteration, forgery or falsification of the content or appearance of this document is unlawful and offenders may be prosecuted to the fullest extent of the law. Unless otherwise stated the results shown in this test report refer only to the sample(s) tested and such sample(s) are retained for 30 days only.  
**Attention: To check the authenticity of testing/inspection report & certificate, please contact us at telephone: (86-755) 8307 1443, or email: CN.Doccheck@sgs.com**

South of No. 6 Plant, No. 1, Runsheng Road, Suzhou Industrial Park, Suzhou Area, China (Jiangsu) Pilot Free Trade Zone 215000  
 中国·苏州·中国(江苏)自由贸易试验区苏州片区苏州工业园区润胜路1号的6号厂房南部 邮编: 215000

t (86-512) 62992980 www.sgsgroup.com.cn  
 t (86-512) 62992980 sgs.china@sgs.com



Test Graphs



Unless otherwise agreed in writing, this document is issued by the Company subject to its General Conditions of Service printed overleaf, available on request or accessible at <http://www.sgs.com/en/Terms-and-Conditions.aspx> and, for electronic format documents, subject to Terms and Conditions for Electronic Documents at <http://www.sgs.com/en/Terms-and-Conditions/Terms-e-Document.aspx>. Attention is drawn to the limitation of liability, indemnification and jurisdiction issues defined therein. Any holder of this document is advised that information contained hereon reflects the Company's findings at the time of its intervention only and within the limits of Client's instructions, if any. The Company's sole responsibility is to its Client and this document does not exonerate parties to a transaction from exercising all their rights and obligations under the transaction documents. This document cannot be reproduced except in full, without prior written approval of the Company. Any unauthorized alteration, forgery or falsification of the content or appearance of this document is unlawful and offenders may be prosecuted to the fullest extent of the law. Unless otherwise stated the results shown in this test report refer only to the sample(s) tested and such sample(s) are retained for 30 days only.

Attention: To check the authenticity of testing/inspection report & certificate, please contact us at telephone: (86-755) 83071443, or email: [CN.Doccheck@sgs.com](mailto:CN.Doccheck@sgs.com)

South of No. 6 Plant, No. 1, Runsheng Road, Suzhou Industrial Park, Suzhou Area, China (Jiangsu) Pilot Free Trade Zone 215000 t (86-512) 62992980 www.sgs.com.cn  
 中国·苏州·中国(江苏)自由贸易试验区苏州片区工业园区润胜路1号的6号厂房南楼 邮编: 215000 t (86-512) 62992980 sgs.china@sgs.com

BLE\_1M\_Ant1\_2480



BLE\_2M\_Ant1\_2402

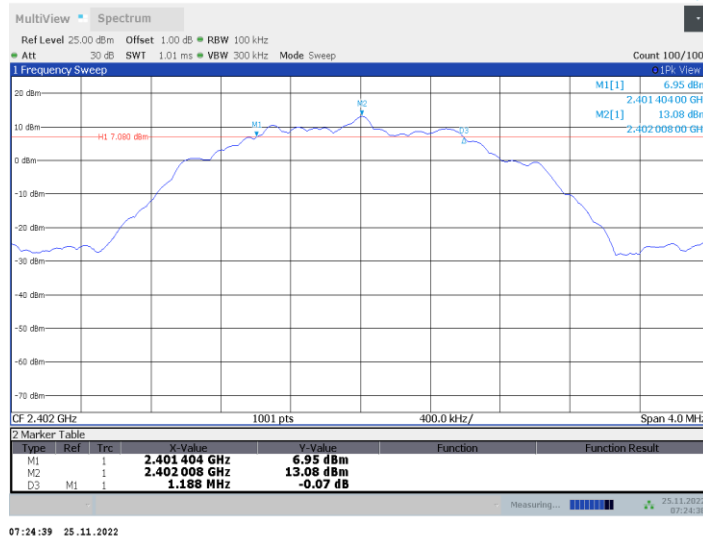

Unless otherwise agreed in writing, this document is issued by the Company subject to its General Conditions of Service printed overleaf, available on request or accessible at <http://www.sgs.com/en/Terms-and-Conditions.aspx> and, for electronic format documents, subject to Terms and Conditions for Electronic Documents at <http://www.sgs.com/en/Terms-and-Conditions/Terms-e-Documents.aspx>. Attention is drawn to the limitation of liability, indemnification and jurisdiction issues defined therein. Any holder of this document is advised that information contained hereon reflects the Company's findings at the time of its intervention only and within the limits of Client's instructions, if any. The Company's sole responsibility is to its Client and this document does not exonerate parties to a transaction from exercising all their rights and obligations under the transaction documents. This document cannot be reproduced except in full, without prior written approval of the Company. Any unauthorized alteration, forgery or falsification of the content or appearance of this document is unlawful and offenders may be prosecuted to the fullest extent of the law. Unless otherwise stated the results shown in this test report refer only to the sample(s) tested and such sample(s) are retained for 30 days only.

Attention: To check the authenticity of testing/inspection report & certificate, please contact us at telephone: (86-755) 8307 1443, or email: [CN.Doccheck@sgs.com](mailto:CN.Doccheck@sgs.com)

South of No. 6 Plant, No. 1, Runsheng Road, Suzhou Industrial Park, Suzhou Area, China (Jiangsu) Pilot Free Trade Zone 215000  
 中国·苏州·中国(江苏)自由贸易试验区苏州片区苏州工业园区润胜路1号的6号厂房南楼 邮编: 215000

t (86-512) 62992980 www.sgs.com.cn  
 t (86-512) 62992980 sgs.china@sgs.com

BLE\_2M\_Ant1\_2440

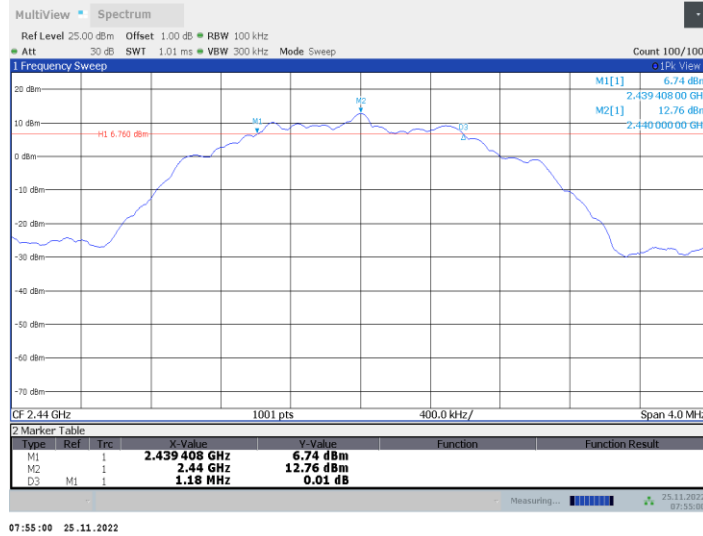

BLE\_2M\_Ant1\_2480

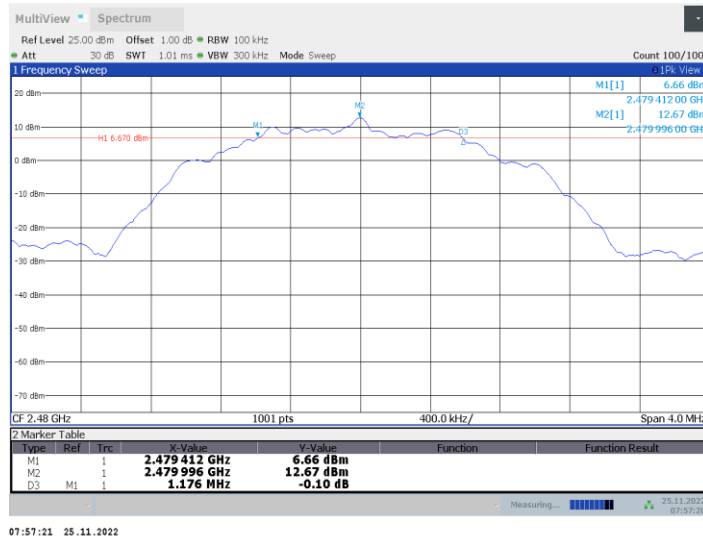

Unless otherwise agreed in writing, this document is issued by the Company subject to its General Conditions of Service printed overleaf, available on request or accessible at <http://www.sgs.com/en/Terms-and-Conditions.aspx> and, for electronic format documents, subject to Terms and Conditions for Electronic Documents at <http://www.sgs.com/en/Terms-and-Conditions/Terms-e-Documents.aspx>. Attention is drawn to the limitation of liability, indemnification and jurisdiction issues defined therein. Any holder of this document is advised that information contained hereon reflects the Company's findings at the time of its intervention only and within the limits of Client's instructions, if any. The Company's sole responsibility is to its Client and this document does not exonerate parties to a transaction from exercising all their rights and obligations under the transaction documents. This document cannot be reproduced except in full, without prior written approval of the Company. Any unauthorized alteration, forgery or falsification of the content or appearance of this document is unlawful and offenders may be prosecuted to the fullest extent of the law. Unless otherwise stated the results shown in this test report refer only to the sample(s) tested and such sample(s) are retained for 30 days only.

Attention: To check the authenticity of testing/inspection report & certificate, please contact us at telephone: (86-755) 83071443, or email: [CN.Doccheck@sgs.com](mailto:CN.Doccheck@sgs.com)

South of No. 6 Plant, No. 1, Runsheng Road, Suzhou Industrial Park, Suzhou Area, China (Jiangsu) Pilot Free Trade Zone 215000 t (86-512) 62992980 www.sgs.com.cn  
 中国·苏州·中国(江苏)自由贸易试验区苏州片区苏州工业园区润胜路1号的6号厂房南楼 邮编: 215000 t (86-512) 62992980 sgs.china@sgs.com

Report No.: SEWM2210000221RG04

Rev.: 01

Page: 36 of 79

### Occupied Channel Bandwidth Test Result

| TestMode | Antenna | Frequency[MHz] | OCB [MHz] | FL[MHz]  | FH[MHz]  | Verdict        |
|----------|---------|----------------|-----------|----------|----------|----------------|
| BLE_1M   | Ant1    | 2402           | 1.032     | 2401.493 | 2402.524 | Reporting only |
|          |         | 2440           | 1.023     | 2439.492 | 2440.515 |                |
|          |         | 2480           | 1.018     | 2479.494 | 2480.513 |                |
| BLE_2M   | Ant1    | 2402           | 2.029     | 2400.997 | 2403.026 |                |
|          |         | 2440           | 2.029     | 2438.995 | 2441.024 |                |
|          |         | 2480           | 2.026     | 2478.995 | 2481.021 |                |



Unless otherwise agreed in writing, this document is issued by the Company subject to its General Conditions of Service printed overleaf, available on request or accessible at <http://www.sgs.com/en/Terms-and-Conditions.aspx> and, for electronic format documents, subject to Terms and Conditions for Electronic Documents at <http://www.sgs.com/en/Terms-and-Conditions/Terms-e-Document.aspx>. Attention is drawn to the limitation of liability, indemnification and jurisdiction issues defined therein. Any holder of this document is advised that information contained hereon reflects the Company's findings at the time of its intervention only and within the limits of Client's instructions, if any. The Company's sole responsibility is to its Client and this document does not exonerate parties to a transaction from exercising all their rights and obligations under the transaction documents. This document cannot be reproduced except in full, without prior written approval of the Company. Any unauthorized alteration, forgery or falsification of the content or appearance of this document is unlawful and offenders may be prosecuted to the fullest extent of the law. Unless otherwise stated the results shown in this test report refer only to the sample(s) tested and such sample(s) are retained for 30 days only.  
Attention: To check the authenticity of testing/inspection report & certificate, please contact us at telephone: (86-755) 8307 1443, or email: [CN.Doccheck@sgs.com](mailto:CN.Doccheck@sgs.com)

South of No. 6 Plant, No. 1, Runsheng Road, Suzhou Industrial Park, Suzhou Area, China (Jiangsu) Pilot Free Trade Zone 215000  
中国·苏州·中国(江苏)自由贸易试验区苏州片区苏州工业园区润胜路1号的6号厂房南楼 邮编: 215000

t (86-512) 62992980 www.sgs.com.cn  
t (86-512) 62992980 sgs.china@sgs.com

Test Graphs



Unless otherwise agreed in writing, this document is issued by the Company subject to its General Conditions of Service printed overleaf, available on request or accessible at <http://www.sgs.com/en/Terms-and-Conditions.aspx> and, for electronic format documents, subject to Terms and Conditions for Electronic Documents at <http://www.sgs.com/en/Terms-and-Conditions/Terms-e-Documents.aspx>. Attention is drawn to the limitation of liability, indemnification and jurisdiction issues defined therein. Any holder of this document is advised that information contained hereon reflects the Company's findings at the time of its intervention only and within the limits of Client's instructions, if any. The Company's sole responsibility is to its Client and this document does not exonerate parties to a transaction from exercising all their rights and obligations under the transaction documents. This document cannot be reproduced except in full, without prior written approval of the Company. Any unauthorized alteration, forgery or falsification of the content or appearance of this document is unlawful and offenders may be prosecuted to the fullest extent of the law. Unless otherwise stated the results shown in this test report refer only to the sample(s) tested and such sample(s) are retained for 30 days only.

Attention: To check the authenticity of testing/inspection report & certificate, please contact us at telephone: (86-755) 8307 1443, or email: [CN.Doccheck@sgs.com](mailto:CN.Doccheck@sgs.com)

South of No. 6 Plant, No. 1, Runsheng Road, Suzhou Industrial Park, Suzhou Area, China (Jiangsu) Pilot Free Trade Zone 215000 t (86-512) 62992980 www.sgs.com.cn  
 中国·苏州·中国 (江苏) 自由贸易试验区苏州片区工业园区润胜路1号的6号厂房南楼 邮编: 215000 t (86-512) 62992980 sgs.china@sgs.com

BLE\_1M\_Ant1\_2480

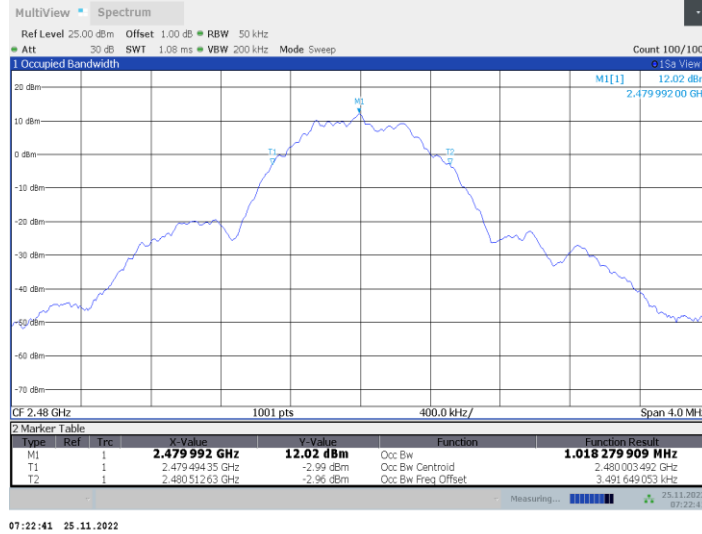

BLE\_2M\_Ant1\_2402



Unless otherwise agreed in writing, this document is issued by the Company subject to its General Conditions of Service printed overleaf, available on request or accessible at <http://www.sgs.com/en/Terms-and-Conditions.aspx> and, for electronic format documents, subject to Terms and Conditions for Electronic Documents at <http://www.sgs.com/en/Terms-and-Conditions/Terms-e-Documents.aspx>. Attention is drawn to the limitation of liability, indemnification and jurisdiction issues defined therein. Any holder of this document is advised that information contained hereon reflects the Company's findings at the time of its intervention only and within the limits of Client's instructions, if any. The Company's sole responsibility is to its Client and this document does not exonerate parties to a transaction from exercising all their rights and obligations under the transaction documents. This document cannot be reproduced except in full, without prior written approval of the Company. Any unauthorized alteration, forgery or falsification of the content or appearance of this document is unlawful and offenders may be prosecuted to the fullest extent of the law. Unless otherwise stated the results shown in this test report refer only to the sample(s) tested and such sample(s) are retained for 30 days only.  
**Attention: To check the authenticity of testing/inspection report & certificate, please contact us at telephone: (86-755) 8307 1443, or email: CN.Doccheck@sgs.com**

South of No. 6 Plant, No. 1, Runsheng Road, Suzhou Industrial Park, Suzhou Area, China (Jiangsu) Pilot Free Trade Zone 215000 t (86-512) 62992980 www.sgs.com.cn  
 中国·苏州·中国(江苏)自由贸易试验区苏州片区苏州工业园区润胜路1号的6号厂房南楼 邮编: 215000 t (86-512) 62992980 sgs.china@sgs.com

BLE\_2M\_Ant1\_2440

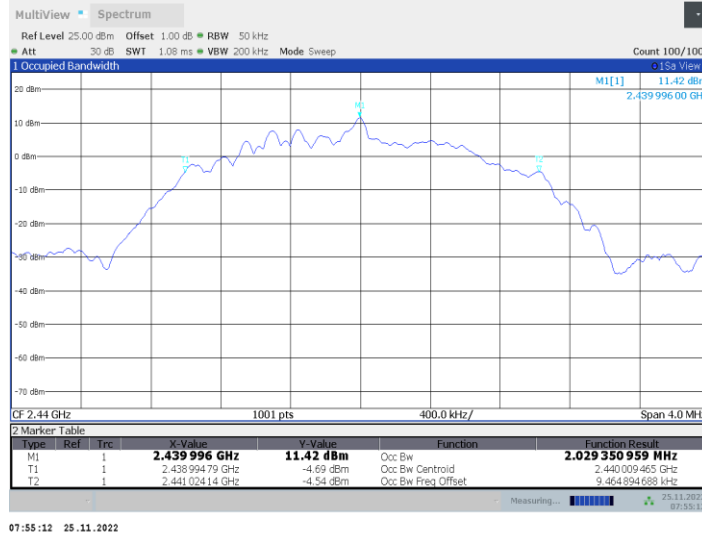

BLE\_2M\_Ant1\_2480



Unless otherwise agreed in writing, this document is issued by the Company subject to its General Conditions of Service printed overleaf, available on request or accessible at <http://www.sgs.com/en/Terms-and-Conditions.aspx> and, for electronic format documents, subject to Terms and Conditions for Electronic Documents at <http://www.sgs.com/en/Terms-and-Conditions/Terms-e-Document.aspx>. Attention is drawn to the limitation of liability, indemnification and jurisdiction issues defined therein. Any holder of this document is advised that information contained hereon reflects the Company's findings at the time of its intervention only and within the limits of Client's instructions, if any. The Company's sole responsibility is to its Client and this document does not exonerate parties to a transaction from exercising all their rights and obligations under the transaction documents. This document cannot be reproduced except in full, without prior written approval of the Company. Any unauthorized alteration, forgery or falsification of the content or appearance of this document is unlawful and offenders may be prosecuted to the fullest extent of the law. Unless otherwise stated the results shown in this test report refer only to the sample(s) tested and such sample(s) are retained for 30 days only.

Attention: To check the authenticity of testing/inspection report & certificate, please contact us at telephone: (86-755) 8307 1443, or email: [CN.Doccheck@sgs.com](mailto:CN.Doccheck@sgs.com)

South of No. 6 Plant, No. 1, Runsheng Road, Suzhou Industrial Park, Suzhou Area, China (Jiangsu) Pilot Free Trade Zone 215000 t (86-512) 62992980 www.sgs.com.cn  
 中国·苏州·中国(江苏)自由贸易试验区苏州片区苏州工业园区润胜路1号的6号厂房南楼 邮编: 215000 t (86-512) 62992980 sgs.china@sgs.com

Report No.: SEWM2210000221RG04

Rev.: 01

Page: 40 of 79

### Maximum conducted output power Test Result Peak

| TestMode | Antenna | Frequency[MHz] | Conducted Peak Power[dBm] | Conducted Limit[dBm] | Verdict |
|----------|---------|----------------|---------------------------|----------------------|---------|
| BLE_1M   | Ant1    | 2402           | 13.82                     | ≤30                  | PASS    |
|          |         | 2440           | 13.52                     | ≤30                  | PASS    |
|          |         | 2480           | 13.62                     | ≤30                  | PASS    |
| BLE_2M   | Ant1    | 2402           | 13.68                     | ≤30                  | PASS    |
|          |         | 2440           | 13.69                     | ≤30                  | PASS    |
|          |         | 2480           | 13.66                     | ≤30                  | PASS    |



Unless otherwise agreed in writing, this document is issued by the Company subject to its General Conditions of Service printed overleaf, available on request or accessible at <http://www.sgs.com/en/Terms-and-Conditions.aspx> and, for electronic format documents, subject to Terms and Conditions for Electronic Documents at <http://www.sgs.com/en/Terms-and-Conditions/Terms-e-Documents.aspx>. Attention is drawn to the limitation of liability, indemnification and jurisdiction issues defined therein. Any holder of this document is advised that information contained hereon reflects the Company's findings at the time of its intervention only and within the limits of Client's instructions, if any. The Company's sole responsibility is to its Client and this document does not exonerate parties to a transaction from exercising all their rights and obligations under the transaction documents. This document cannot be reproduced except in full, without prior written approval of the Company. Any unauthorized alteration, forgery or falsification of the content or appearance of this document is unlawful and offenders may be prosecuted to the fullest extent of the law. Unless otherwise stated the results shown in this test report refer only to the sample(s) tested and such sample(s) are retained for 30 days only.  
Attention: To check the authenticity of testing/inspection report & certificate, please contact us at telephone: (86-755) 8307 1443, or email: [CN.Doccheck@sgs.com](mailto:CN.Doccheck@sgs.com)

South of No. 6 Plant, No. 1, Runsheng Road, Suzhou Industrial Park, Suzhou Area, China (Jiangsu) Pilot Free Trade Zone 215000  
中国·苏州·中国(江苏)自由贸易试验区苏州片区苏州工业园区润胜路1号的6号厂房南楼 邮编: 215000

t (86-512) 62992980 www.sgs.com.cn  
t (86-512) 62992980 sgs.china@sgs.com



Report No.: SEWM2210000221RG04

Rev.: 01

Page: 41 of 79

### Maximum power spectral density Test Result

| TestMode | Antenna | Frequency[MHz] | Result[dBm/3kHz] | Limit[dBm/3kHz] | Verdict |
|----------|---------|----------------|------------------|-----------------|---------|
| BLE_1M   | Ant1    | 2402           | -1.39            | ≤8.00           | PASS    |
|          |         | 2440           | -1.42            | ≤8.00           | PASS    |
|          |         | 2480           | -1.51            | ≤8.00           | PASS    |
| BLE_2M   | Ant1    | 2402           | -4.18            | ≤8.00           | PASS    |
|          |         | 2440           | -4.3             | ≤8.00           | PASS    |
|          |         | 2480           | -4.11            | ≤8.00           | PASS    |



Unless otherwise agreed in writing, this document is issued by the Company subject to its General Conditions of Service printed overleaf, available on request or accessible at <http://www.sgs.com/en/Terms-and-Conditions.aspx> and, for electronic format documents, subject to Terms and Conditions for Electronic Documents at <http://www.sgs.com/en/Terms-and-Conditions/Terms-e-Documents.aspx>. Attention is drawn to the limitation of liability, indemnification and jurisdiction issues defined therein. Any holder of this document is advised that information contained hereon reflects the Company's findings at the time of its intervention only and within the limits of Client's instructions, if any. The Company's sole responsibility is to its Client and this document does not exonerate parties to a transaction from exercising all their rights and obligations under the transaction documents. This document cannot be reproduced except in full, without prior written approval of the Company. Any unauthorized alteration, forgery or falsification of the content or appearance of this document is unlawful and offenders may be prosecuted to the fullest extent of the law. Unless otherwise stated the results shown in this test report refer only to the sample(s) tested and such sample(s) are retained for 30 days only.  
Attention: To check the authenticity of testing/inspection report & certificate, please contact us at telephone: (86-755) 8307 1443, or email: [CN.Doccheck@sgs.com](mailto:CN.Doccheck@sgs.com)

South of No. 6 Plant, No. 1, Runsheng Road, Suzhou Industrial Park, Suzhou Area, China (Jiangsu) Pilot Free Trade Zone 215000  
中国·苏州·中国(江苏)自由贸易试验区苏州片区苏州工业园区润胜路1号的6号厂房南楼 邮编: 215000

t (86-512) 62992980 www.sgs.com.cn  
t (86-512) 62992980 sgs.china@sgs.com

Test Graphs

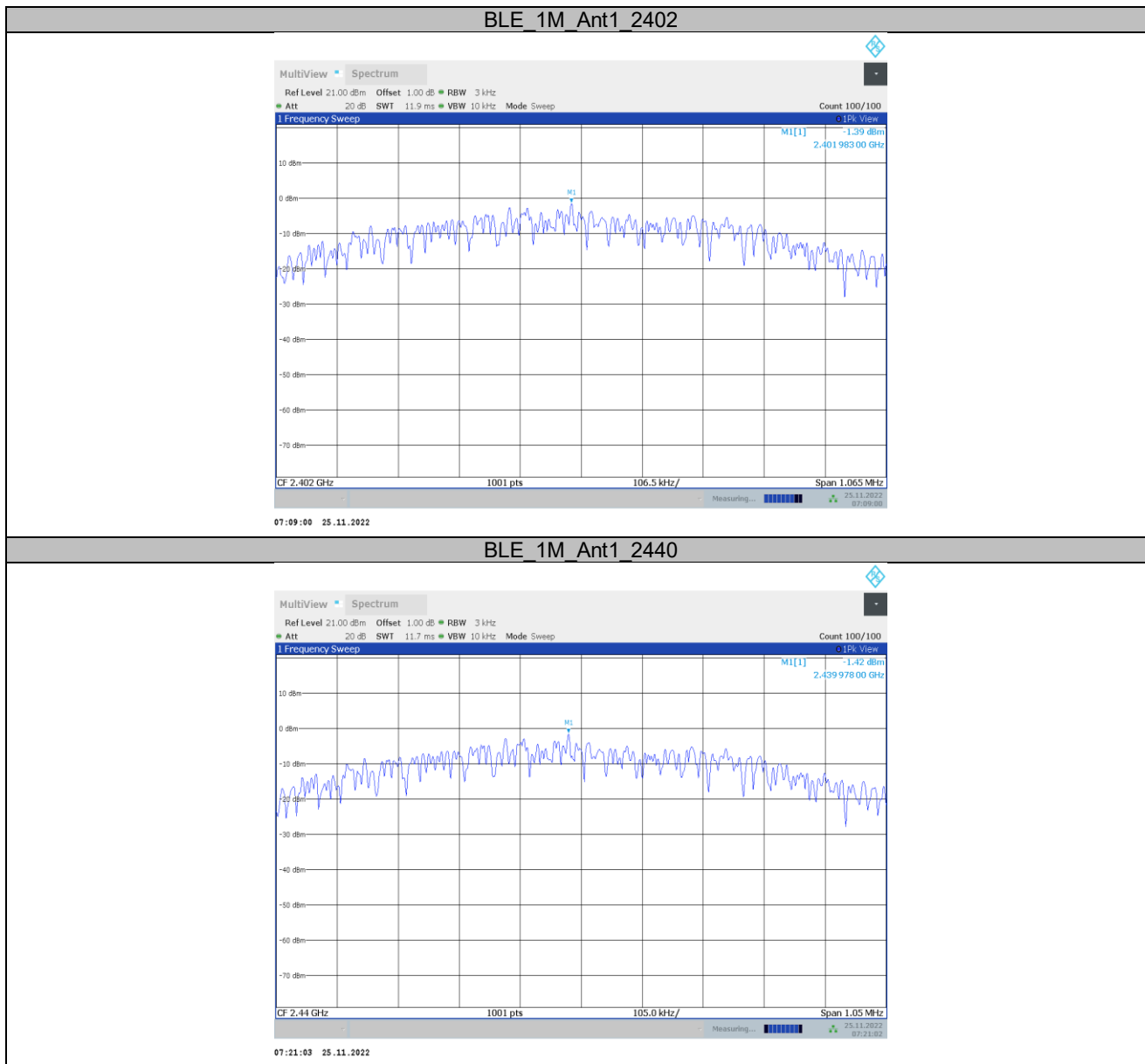

Unless otherwise agreed in writing, this document is issued by the Company subject to its General Conditions of Service printed overleaf, available on request or accessible at <http://www.sgs.com/en/Terms-and-Conditions.aspx> and, for electronic format documents, subject to Terms and Conditions for Electronic Documents at <http://www.sgs.com/en/Terms-and-Conditions/Terms-e-Documents.aspx>. Attention is drawn to the limitation of liability, indemnification and jurisdiction issues defined therein. Any holder of this document is advised that information contained hereon reflects the Company's findings at the time of its intervention only and within the limits of Client's instructions, if any. The Company's sole responsibility is to its Client and this document does not exonerate parties to a transaction from exercising all their rights and obligations under the transaction documents. This document cannot be reproduced except in full, without prior written approval of the Company. Any unauthorized alteration, forgery or falsification of the content or appearance of this document is unlawful and offenders may be prosecuted to the fullest extent of the law. Unless otherwise stated the results shown in this test report refer only to the sample(s) tested and such sample(s) are retained for 30 days only.  
 Attention: To check the authenticity of testing/inspection report & certificate, please contact us at telephone: (86-755) 8307 1443, or email: [CN.Doccheck@sgs.com](mailto:CN.Doccheck@sgs.com)  
 South of No. 6 Plant, No. 1, Runsheng Road, Suzhou Industrial Park, Suzhou Area, China (Jiangsu) Pilot Free Trade Zone 215000 t (86-512) 62992980 www.sgs.com.cn  
 中国·苏州·中国(江苏)自由贸易试验区苏州片区苏州工业园区润胜路1号的6号厂房南楼 邮编: 215000 t (86-512) 62992980 sgs.china@sgs.com

BLE\_1M\_Ant1\_2480

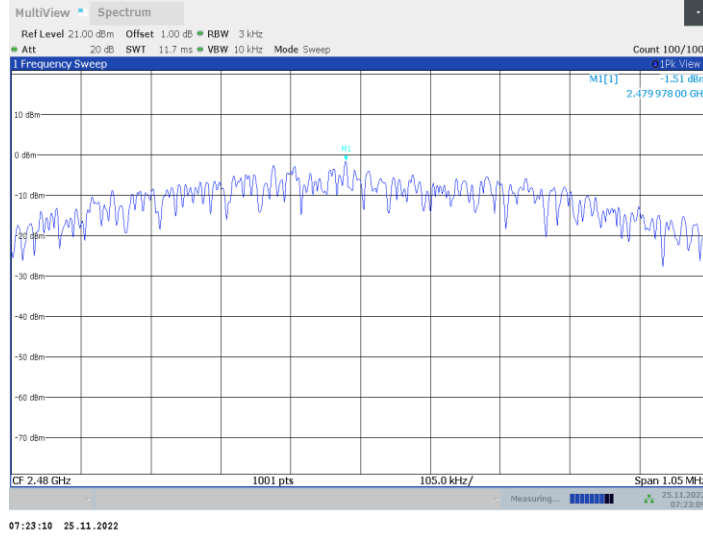

BLE\_2M\_Ant1\_2402

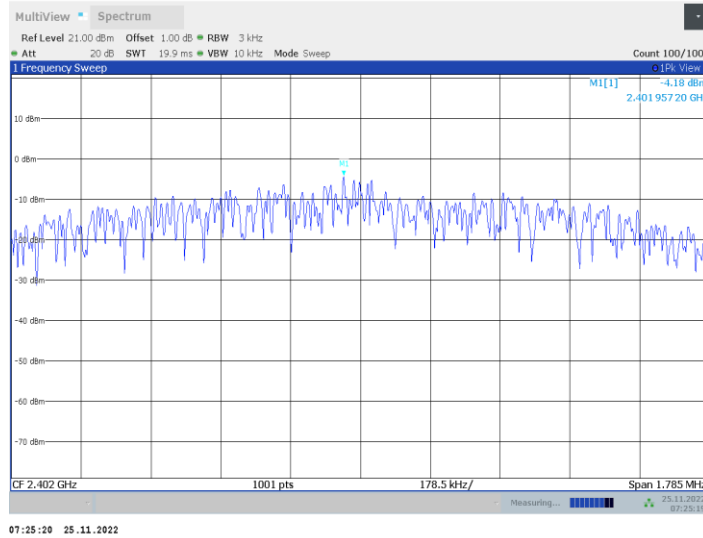

Unless otherwise agreed in writing, this document is issued by the Company subject to its General Conditions of Service printed overleaf, available on request or accessible at <http://www.sgs.com/en/Terms-and-Conditions.aspx> and, for electronic format documents, subject to Terms and Conditions for Electronic Documents at <http://www.sgs.com/en/Terms-and-Conditions/Terms-e-Documents.aspx>. Attention is drawn to the limitation of liability, indemnification and jurisdiction issues defined therein. Any holder of this document is advised that information contained hereon reflects the Company's findings at the time of its intervention only and within the limits of Client's instructions, if any. The Company's sole responsibility is to its Client and this document does not exonerate parties to a transaction from exercising all their rights and obligations under the transaction documents. This document cannot be reproduced except in full, without prior written approval of the Company. Any unauthorized alteration, forgery or falsification of the content or appearance of this document is unlawful and offenders may be prosecuted to the fullest extent of the law. Unless otherwise stated the results shown in this test report refer only to the sample(s) tested and such sample(s) are retained for 30 days only.

Attention: To check the authenticity of testing/inspection report & certificate, please contact us at telephone: (86-755) 8307 1443, or email: [CN.Doccheck@sgs.com](mailto:CN.Doccheck@sgs.com)

South of No. 6 Plant, No. 1, Runsheng Road, Suzhou Industrial Park, Suzhou Area, China (Jiangsu) Pilot Free Trade Zone 215000 t (86-512) 62992980 www.sgs.com.cn  
 中国·苏州·中国(江苏)自由贸易试验区苏州片区苏州工业园区润胜路1号的6号厂房南楼 邮编: 215000 t (86-512) 62992980 sgs.china@sgs.com

BLE\_2M\_Ant1\_2440

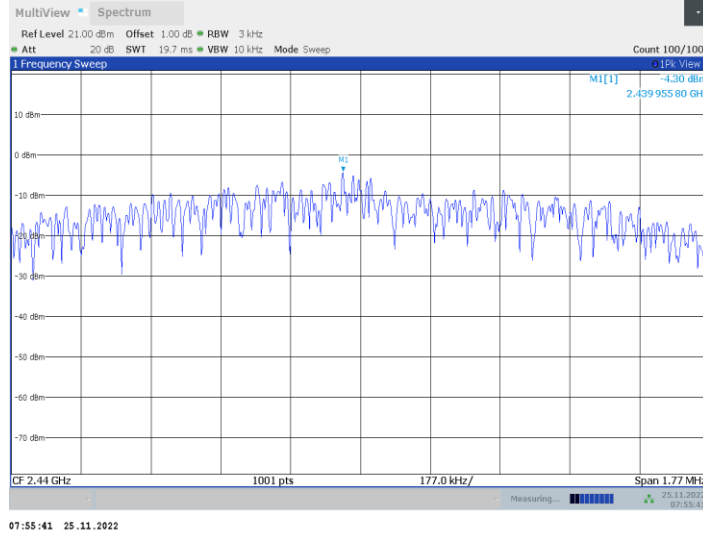

BLE\_2M\_Ant1\_2480

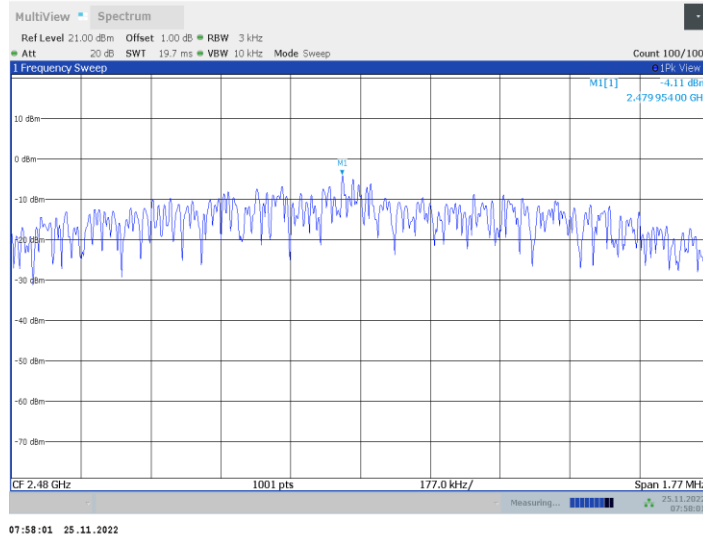

Unless otherwise agreed in writing, this document is issued by the Company subject to its General Conditions of Service printed overleaf, available on request or accessible at <http://www.sgs.com/en/Terms-and-Conditions.aspx> and, for electronic format documents, subject to Terms and Conditions for Electronic Documents at <http://www.sgs.com/en/Terms-and-Conditions/Terms-e-Documents.aspx>. Attention is drawn to the limitation of liability, indemnification and jurisdiction issues defined therein. Any holder of this document is advised that information contained hereon reflects the Company's findings at the time of its intervention only and within the limits of Client's instructions, if any. The Company's sole responsibility is to its Client and this document does not exonerate parties to a transaction from exercising all their rights and obligations under the transaction documents. This document cannot be reproduced except in full, without prior written approval of the Company. Any unauthorized alteration, forgery or falsification of the content or appearance of this document is unlawful and offenders may be prosecuted to the fullest extent of the law. Unless otherwise stated the results shown in this test report refer only to the sample(s) tested and such sample(s) are retained for 30 days only.

Attention: To check the authenticity of testing/inspection report & certificate, please contact us at telephone: (86-755) 8307 1443, or email: [CN.Doccheck@sgs.com](mailto:CN.Doccheck@sgs.com)

South of No. 6 Plant, No. 1, Runsheng Road, Suzhou Industrial Park, Suzhou Area, China (Jiangsu) Pilot Free Trade Zone 215000 t (86-512) 62992980 www.sgs.com.cn  
 中国·苏州·中国(江苏)自由贸易试验区苏州片区苏州工业园区润胜路1号的6号厂房南楼 邮编: 215000 t (86-512) 62992980 sgs.china@sgs.com

### Band edge measurements Test Graphs

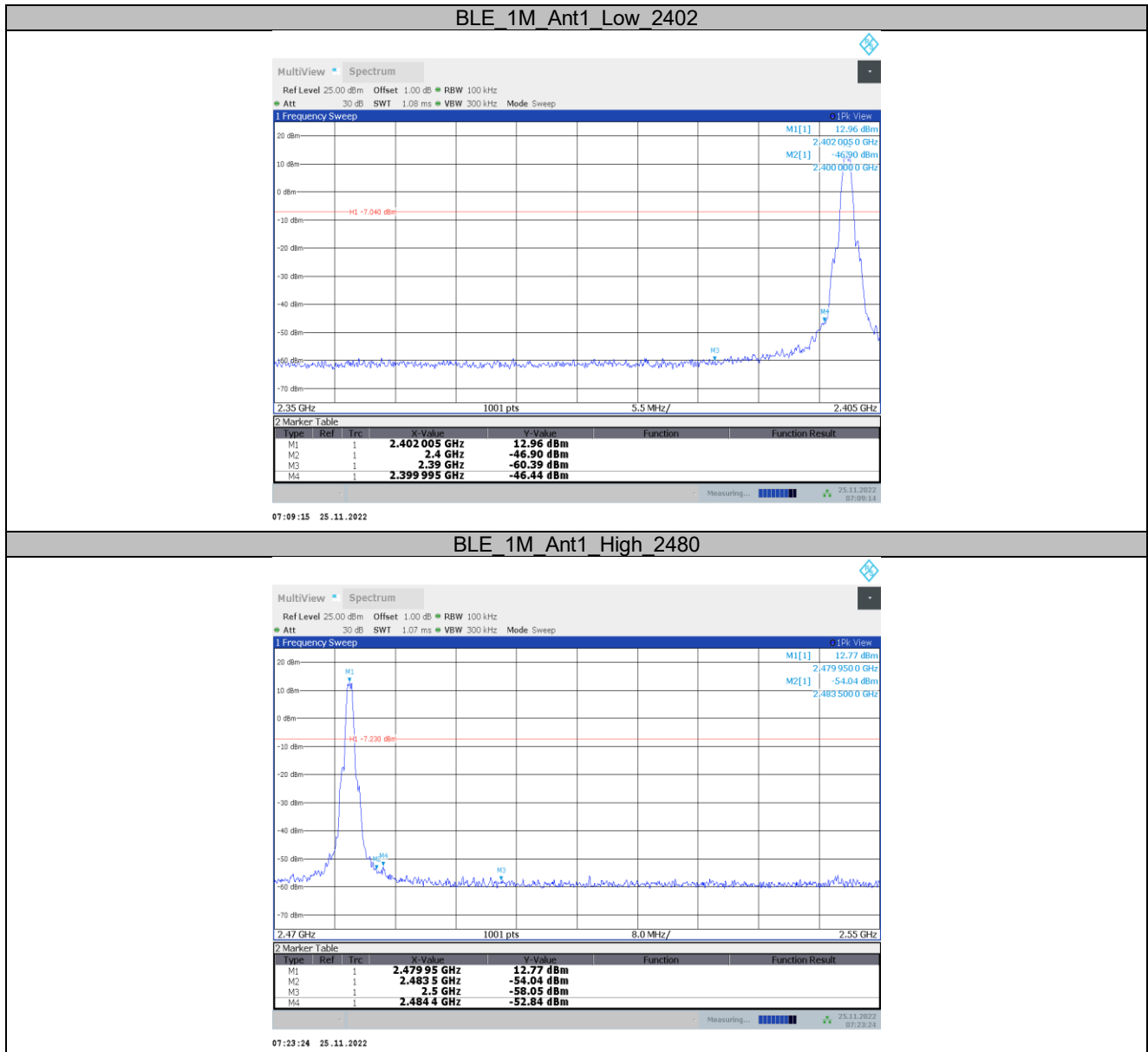

Unless otherwise agreed in writing, this document is issued by the Company subject to its General Conditions of Service printed overleaf, available on request or accessible at <http://www.sgs.com/en/Terms-and-Conditions.aspx> and, for electronic format documents, subject to Terms and Conditions for Electronic Documents at <http://www.sgs.com/en/Terms-and-Conditions/Terms-e-Documents.aspx>. Attention is drawn to the limitation of liability, indemnification and jurisdiction issues defined therein. Any holder of this document is advised that information contained hereon reflects the Company's findings at the time of its intervention only and within the limits of Client's instructions, if any. The Company's sole responsibility is to its Client and this document does not exonerate parties to a transaction from exercising all their rights and obligations under the transaction documents. This document cannot be reproduced except in full, without prior written approval of the Company. Any unauthorized alteration, forgery or falsification of the content or appearance of this document is unlawful and offenders may be prosecuted to the fullest extent of the law. Unless otherwise stated the results shown in this test report refer only to the sample(s) tested and such sample(s) are retained for 30 days only.

**Attention: To check the authenticity of testing/inspection report & certificate, please contact us at telephone: (86-755) 8307 1443, or email: CN.Doccheck@sgs.com**

South of No. 6 Plant, No. 1, Runsheng Road, Suzhou Industrial Park, Suzhou Area, China (Jiangsu) Pilot Free Trade Zone 215000 t (86-512) 62992980 www.sgs.com.cn  
 中国·苏州·中国(江苏)自由贸易试验区苏州片区苏州工业园区润胜路1号的6号厂房南楼 邮编: 215000 t (86-512) 62992980 sgs.china@sgs.com

BLE 2M Ant1 Low 2402

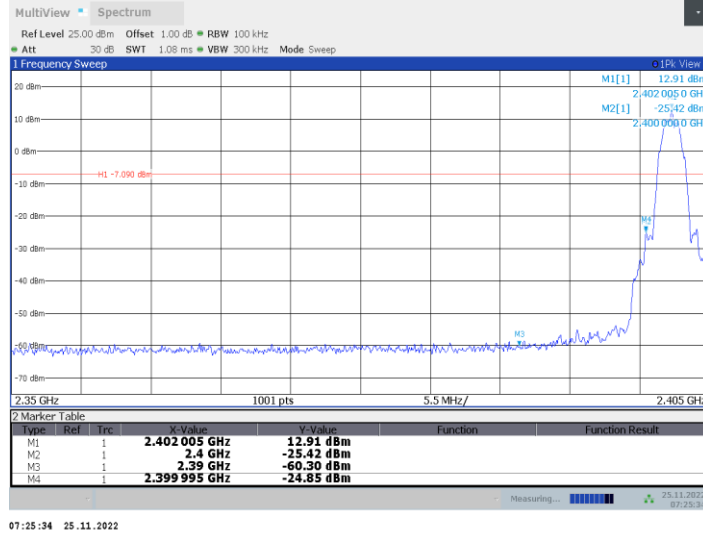

BLE 2M Ant1 High 2480

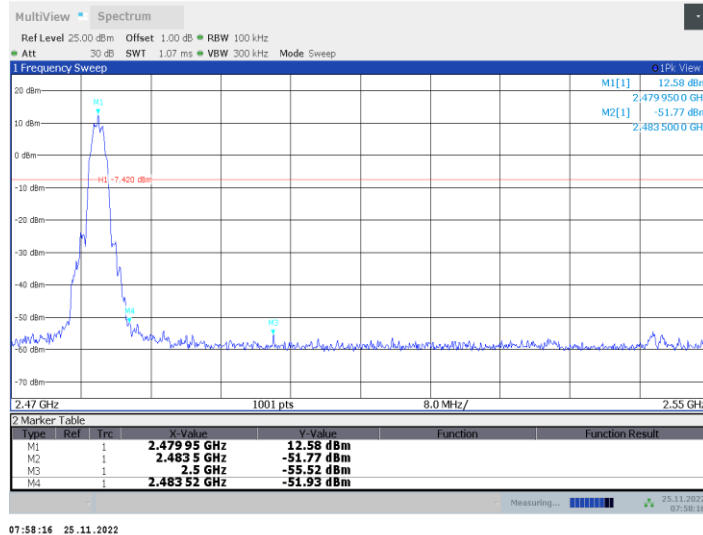

Unless otherwise agreed in writing, this document is issued by the Company subject to its General Conditions of Service printed overleaf, available on request or accessible at <http://www.sgs.com/en/Terms-and-Conditions.aspx> and, for electronic format documents, subject to Terms and Conditions for Electronic Documents at <http://www.sgs.com/en/Terms-and-Conditions/Terms-e-Documents.aspx>. Attention is drawn to the limitation of liability, indemnification and jurisdiction issues defined therein. Any holder of this document is advised that information contained hereon reflects the Company's findings at the time of its intervention only and within the limits of Client's instructions, if any. The Company's sole responsibility is to its Client and this document does not exonerate parties to a transaction from exercising all their rights and obligations under the transaction documents. This document cannot be reproduced except in full, without prior written approval of the Company. Any unauthorized alteration, forgery or falsification of the content or appearance of this document is unlawful and offenders may be prosecuted to the fullest extent of the law. Unless otherwise stated the results shown in this test report refer only to the sample(s) tested and such sample(s) are retained for 30 days only.

Attention: To check the authenticity of testing/inspection report & certificate, please contact us at telephone: (86-755) 8307 1443, or email: [CN.Doccheck@sgs.com](mailto:CN.Doccheck@sgs.com)

South of No. 6 Plant, No. 1, Runsheng Road, Suzhou Industrial Park, Suzhou Area, China (Jiangsu) Pilot Free Trade Zone 215000  
 中国·苏州·中国(江苏)自由贸易试验区苏州片区苏州工业园区润胜路1号的6号厂房南楼 邮编: 215000

t (86-512) 62992980 www.sgs.com.cn  
 t (86-512) 62992980 sgs.china@sgs.com

## Conducted Spurious Emission Test Graphs

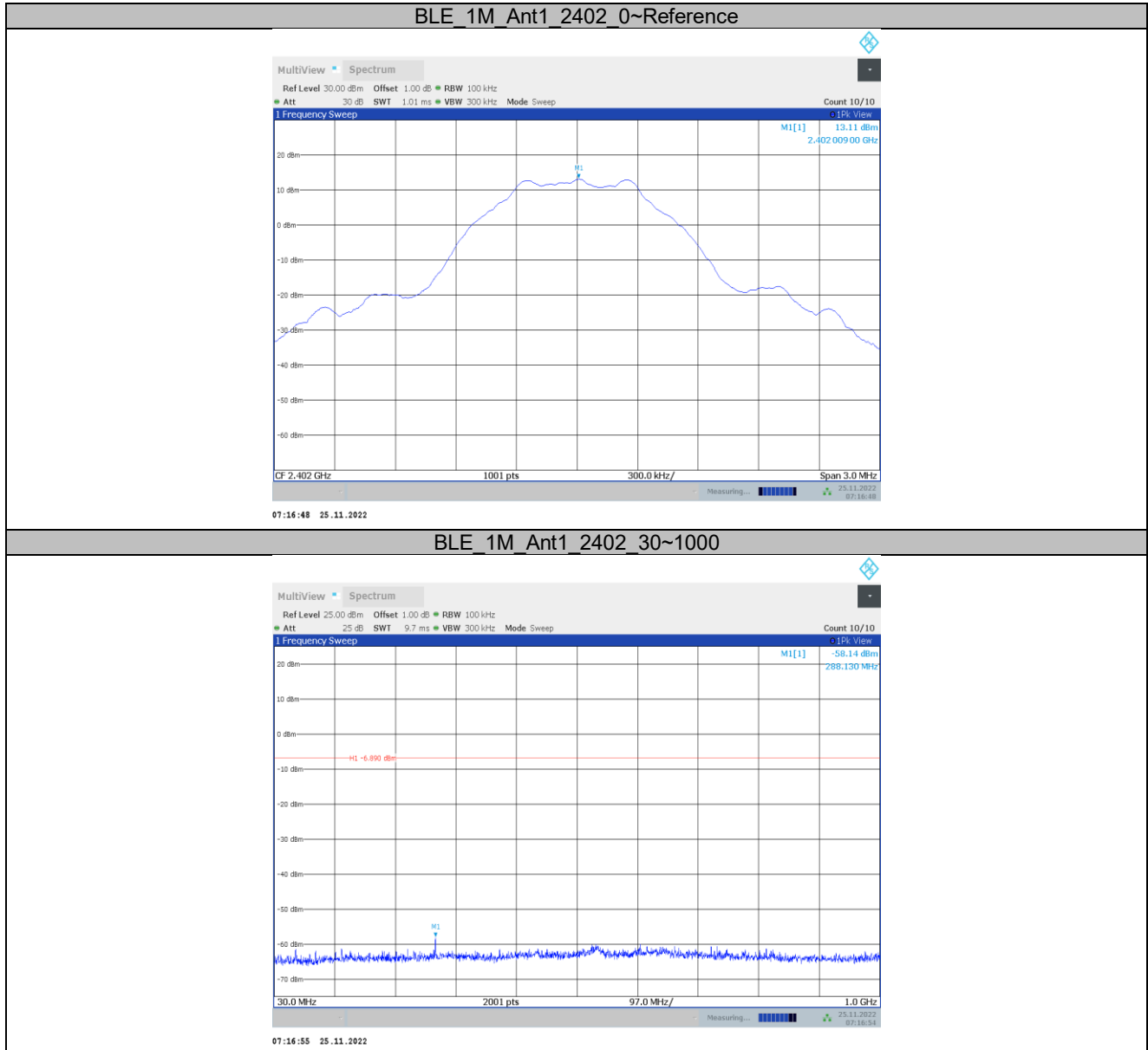

Unless otherwise agreed in writing, this document is issued by the Company subject to its General Conditions of Service printed overleaf, available on request or accessible at <http://www.sgs.com/en/Terms-and-Conditions.aspx> and, for electronic format documents, subject to Terms and Conditions for Electronic Documents at <http://www.sgs.com/en/Terms-and-Conditions/Terms-e-Documents.aspx>. Attention is drawn to the limitation of liability, indemnification and jurisdiction issues defined therein. Any holder of this document is advised that information contained hereon reflects the Company's findings at the time of its intervention only and within the limits of Client's instructions, if any. The Company's sole responsibility is to its Client and this document does not exonerate parties to a transaction from exercising all their rights and obligations under the transaction documents. This document cannot be reproduced except in full, without prior written approval of the Company. Any unauthorized alteration, forgery or falsification of the content or appearance of this document is unlawful and offenders may be prosecuted to the fullest extent of the law. Unless otherwise stated the results shown in this test report refer only to the sample(s) tested and such sample(s) are retained for 30 days only.

Attention: To check the authenticity of testing/inspection report & certificate, please contact us at telephone: (86-755) 8307 1443, or email: [CN.Doccheck@sgs.com](mailto:CN.Doccheck@sgs.com)

BLE\_1M\_Ant1\_2402\_1000~26500

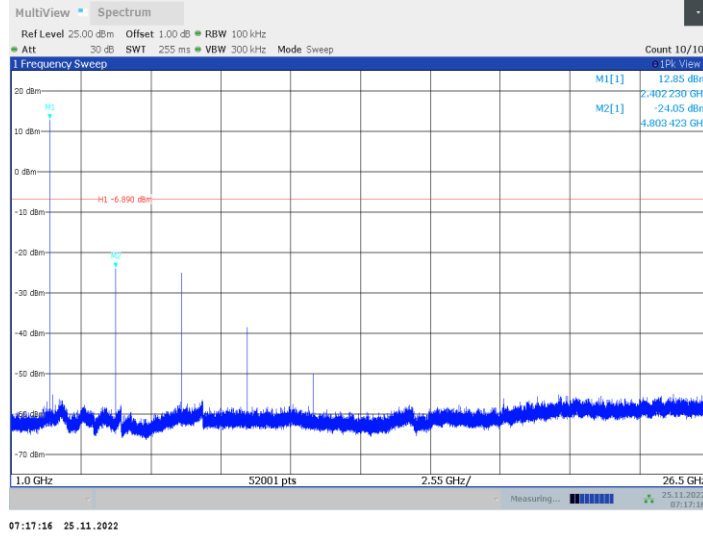

BLE\_1M\_Ant1\_2440\_0~Reference



Unless otherwise agreed in writing, this document is issued by the Company subject to its General Conditions of Service printed overleaf, available on request or accessible at <http://www.sgs.com/en/Terms-and-Conditions.aspx> and, for electronic format documents, subject to Terms and Conditions for Electronic Documents at <http://www.sgs.com/en/Terms-and-Conditions/Terms-e-Document.aspx>. Attention is drawn to the limitation of liability, indemnification and jurisdiction issues defined therein. Any holder of this document is advised that information contained hereon reflects the Company's findings at the time of its intervention only and within the limits of Client's instructions, if any. The Company's sole responsibility is to its Client and this document does not exonerate parties to a transaction from exercising all their rights and obligations under the transaction documents. This document cannot be reproduced except in full, without prior written approval of the Company. Any unauthorized alteration, forgery or falsification of the content or appearance of this document is unlawful and offenders may be prosecuted to the fullest extent of the law. Unless otherwise stated the results shown in this test report refer only to the sample(s) tested and such sample(s) are retained for 30 days only.

Attention: To check the authenticity of testing/inspection report & certificate, please contact us at telephone: (86-755) 83071443, or email: [CN.Doccheck@sgs.com](mailto:CN.Doccheck@sgs.com)

South of No. 6 Plant, No. 1, Runsheng Road, Suzhou Industrial Park, Suzhou Area, China (Jiangsu) Pilot Free Trade Zone 215000 t (86-512) 62992980 www.sgs.com.cn  
 中国·苏州·中国(江苏)自由贸易试验区苏州片区苏州工业园区润胜路1号的6号厂房南楼 邮编: 215000 t (86-512) 62992980 sgs.china@sgs.com



BLE\_1M\_Ant1\_2440\_30~1000

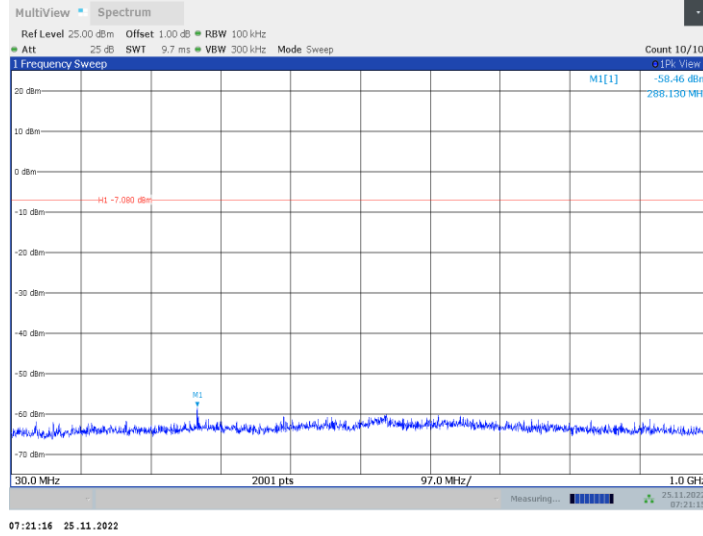

BLE\_1M\_Ant1\_2440\_1000~26500

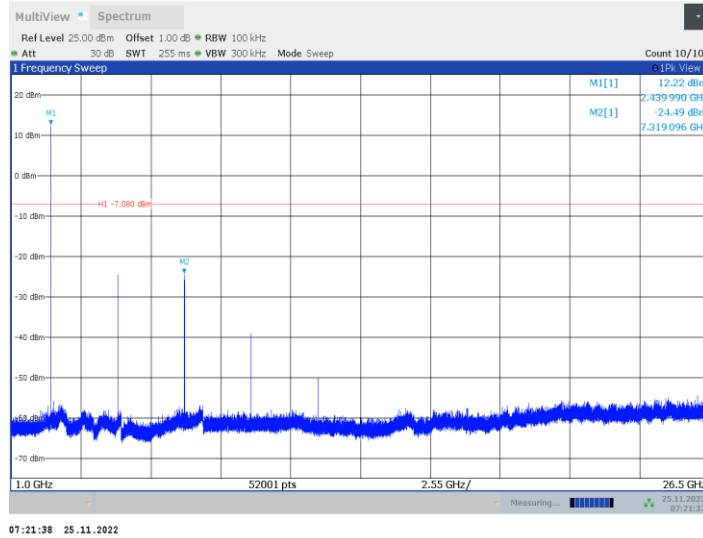

Unless otherwise agreed in writing, this document is issued by the Company subject to its General Conditions of Service printed overleaf, available on request or accessible at <http://www.sgs.com/en/Terms-and-Conditions.aspx> and, for electronic format documents, subject to Terms and Conditions for Electronic Documents at <http://www.sgs.com/en/Terms-and-Conditions/Terms-e-Documents.aspx>. Attention is drawn to the limitation of liability, indemnification and jurisdiction issues defined therein. Any holder of this document is advised that information contained hereon reflects the Company's findings at the time of its intervention only and within the limits of Client's instructions, if any. The Company's sole responsibility is to its Client and this document does not exonerate parties to a transaction from exercising all their rights and obligations under the transaction documents. This document cannot be reproduced except in full, without prior written approval of the Company. Any unauthorized alteration, forgery or falsification of the content or appearance of this document is unlawful and offenders may be prosecuted to the fullest extent of the law. Unless otherwise stated the results shown in this test report refer only to the sample(s) tested and such sample(s) are retained for 30 days only.

Attention: To check the authenticity of testing/inspection report & certificate, please contact us at telephone: (86-755) 8307 1443, or email: [CN.Doccheck@sgs.com](mailto:CN.Doccheck@sgs.com)

South of No. 6 Plant, No. 1, Runsheng Road, Suzhou Industrial Park, Suzhou Area, China (Jiangsu) Pilot Free Trade Zone 215000  
 中国·苏州·中国(江苏)自由贸易试验区苏州片区工业园区润胜路1号的6号厂房南楼 邮编: 215000

t (86-512) 62992980 www.sgs.com.cn  
 t (86-512) 62992980 sgs.china@sgs.com

BLE 1M Ant1 2480 0~Reference

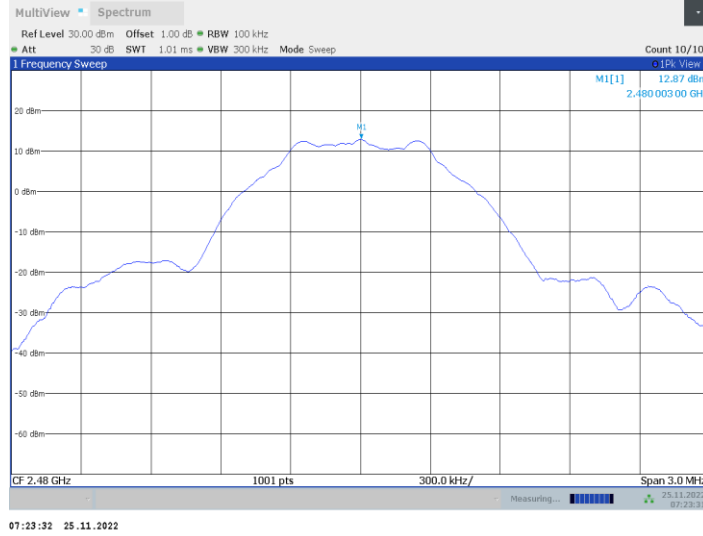

BLE 1M Ant1 2480 30~1000

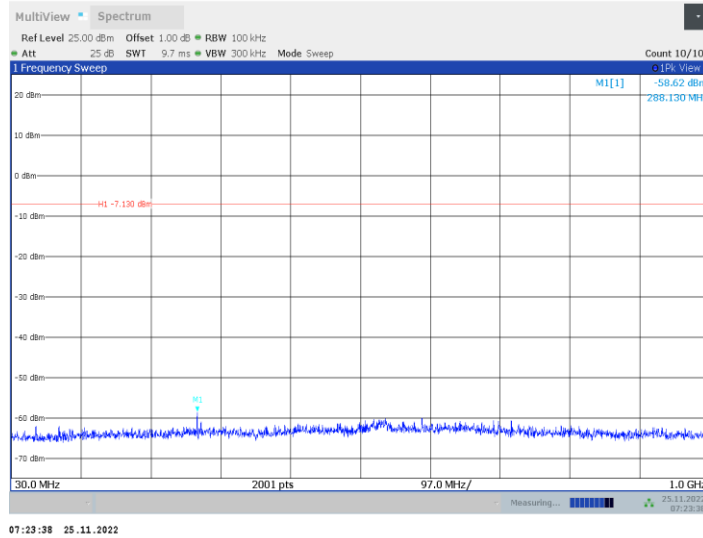

Unless otherwise agreed in writing, this document is issued by the Company subject to its General Conditions of Service printed overleaf, available on request or accessible at <http://www.sgs.com/en/Terms-and-Conditions.aspx> and, for electronic format documents, subject to Terms and Conditions for Electronic Documents at <http://www.sgs.com/en/Terms-and-Conditions/Terms-e-Documents.aspx>. Attention is drawn to the limitation of liability, indemnification and jurisdiction issues defined therein. Any holder of this document is advised that information contained hereon reflects the Company's findings at the time of its intervention only and within the limits of Client's instructions, if any. The Company's sole responsibility is to its Client and this document does not exonerate parties to a transaction from exercising all their rights and obligations under the transaction documents. This document cannot be reproduced except in full, without prior written approval of the Company. Any unauthorized alteration, forgery or falsification of the content or appearance of this document is unlawful and offenders may be prosecuted to the fullest extent of the law. Unless otherwise stated the results shown in this test report refer only to the sample(s) tested and such sample(s) are retained for 30 days only.

Attention: To check the authenticity of testing/inspection report & certificate, please contact us at telephone: (86-755) 8307 1443, or email: [CN.Doccheck@sgs.com](mailto:CN.Doccheck@sgs.com)

South of No. 6 Plant, No. 1, Runsheng Road, Suzhou Industrial Park, Suzhou Area, China (Jiangsu) Pilot Free Trade Zone 215000 t (86-512) 62992980 www.sgs.com.cn  
 中国·苏州·中国 (江苏) 自由贸易试验区苏州片区苏州工业园区润胜路1号的6号厂房南楼 邮编: 215000 t (86-512) 62992980 sgs.china@sgs.com

BLE\_1M\_Ant1\_2480\_1000~26500

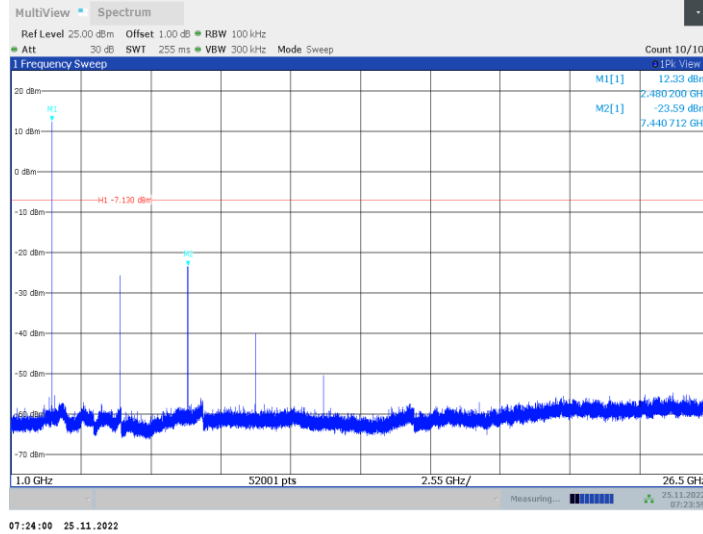

BLE\_2M\_Ant1\_2402\_0~Reference

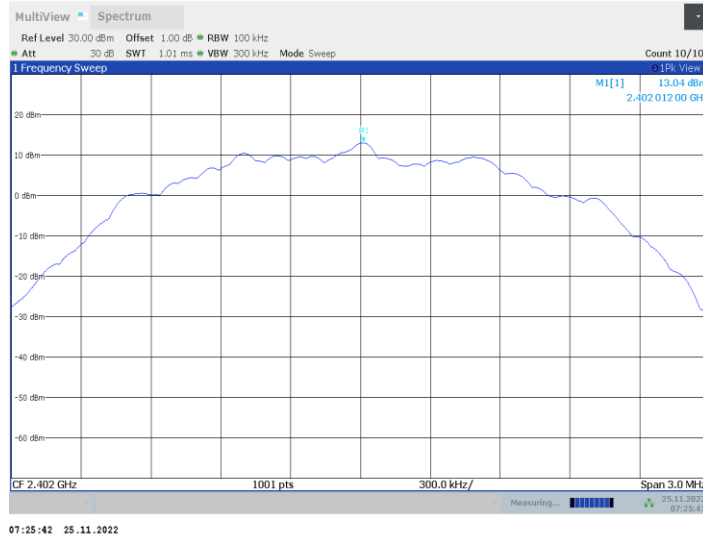

Unless otherwise agreed in writing, this document is issued by the Company subject to its General Conditions of Service printed overleaf, available on request or accessible at <http://www.sgs.com/en/Terms-and-Conditions.aspx> and, for electronic format documents, subject to Terms and Conditions for Electronic Documents at <http://www.sgs.com/en/Terms-and-Conditions/Terms-e-Documents.aspx>. Attention is drawn to the limitation of liability, indemnification and jurisdiction issues defined therein. Any holder of this document is advised that information contained hereon reflects the Company's findings at the time of its intervention only and within the limits of Client's instructions, if any. The Company's sole responsibility is to its Client and this document does not exonerate parties to a transaction from exercising all their rights and obligations under the transaction documents. This document cannot be reproduced except in full, without prior written approval of the Company. Any unauthorized alteration, forgery or falsification of the content or appearance of this document is unlawful and offenders may be prosecuted to the fullest extent of the law. Unless otherwise stated the results shown in this test report refer only to the sample(s) tested and such sample(s) are retained for 30 days only.

Attention: To check the authenticity of testing/inspection report & certificate, please contact us at telephone: (86-755) 8307 1443, or email: [CN.Doccheck@sgs.com](mailto:CN.Doccheck@sgs.com)

South of No. 6 Plant, No. 1, Runsheng Road, Suzhou Industrial Park, Suzhou Area, China (Jiangsu) Pilot Free Trade Zone 215000 t (86-512) 62992980 www.sgs.com.cn  
 中国·苏州·中国(江苏)自由贸易试验区苏州片区苏州工业园区润胜路1号的6号厂房南楼 邮编: 215000 t (86-512) 62992980 sgs.china@sgs.com

BLE\_2M\_Ant1\_2402\_30~1000

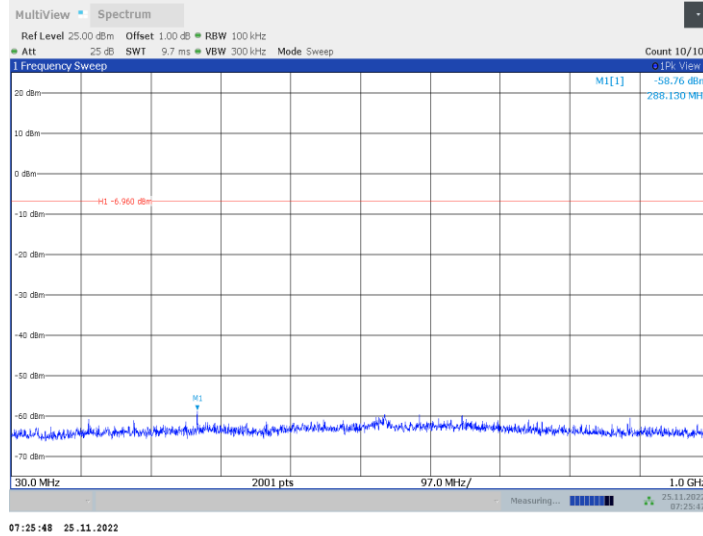

BLE\_2M\_Ant1\_2402\_1000~26500

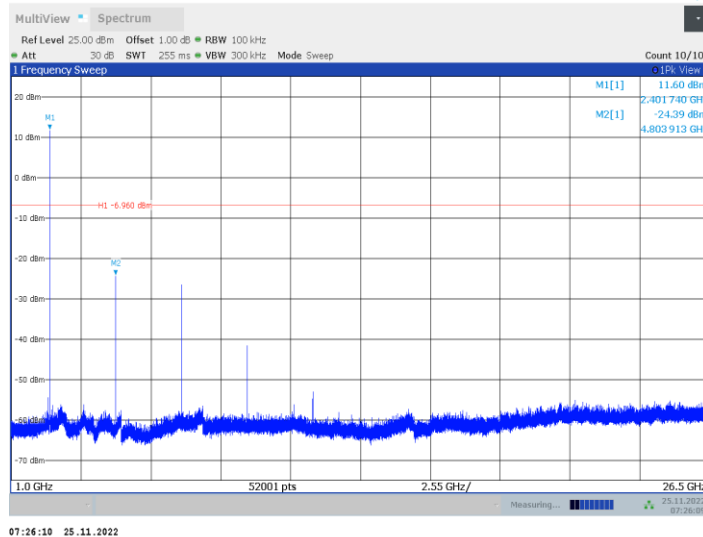

Unless otherwise agreed in writing, this document is issued by the Company subject to its General Conditions of Service printed overleaf, available on request or accessible at <http://www.sgs.com/en/Terms-and-Conditions.aspx> and, for electronic format documents, subject to Terms and Conditions for Electronic Documents at <http://www.sgs.com/en/Terms-and-Conditions/Terms-e-Documents.aspx>. Attention is drawn to the limitation of liability, indemnification and jurisdiction issues defined therein. Any holder of this document is advised that information contained hereon reflects the Company's findings at the time of its intervention only and within the limits of Client's instructions, if any. The Company's sole responsibility is to its Client and this document does not exonerate parties to a transaction from exercising all their rights and obligations under the transaction documents. This document cannot be reproduced except in full, without prior written approval of the Company. Any unauthorized alteration, forgery or falsification of the content or appearance of this document is unlawful and offenders may be prosecuted to the fullest extent of the law. Unless otherwise stated the results shown in this test report refer only to the sample(s) tested and such sample(s) are retained for 30 days only.

Attention: To check the authenticity of testing/inspection report & certificate, please contact us at telephone: (86-755) 83071443, or email: [CN.Doccheck@sgs.com](mailto:CN.Doccheck@sgs.com)

South of No. 6 Plant, No. 1, Runsheng Road, Suzhou Industrial Park, Suzhou Area, China (Jiangsu) Pilot Free Trade Zone 215000 t (86-512) 62992980 www.sgs.com.cn  
 中国·苏州·中国(江苏)自由贸易试验区苏州片区工业园区润胜路1号的6号厂房南楼 邮编: 215000 t (86-512) 62992980 sgs.china@sgs.com

BLE 2M Ant1 2440\_0~Reference

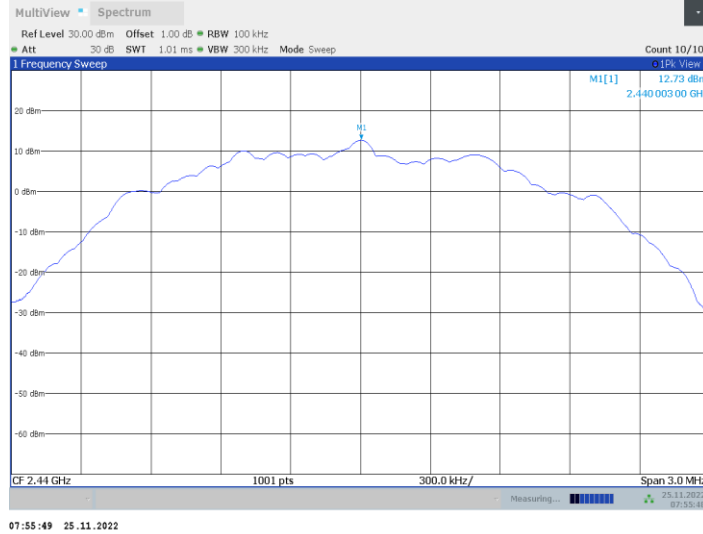

BLE 2M Ant1 2440\_30~1000

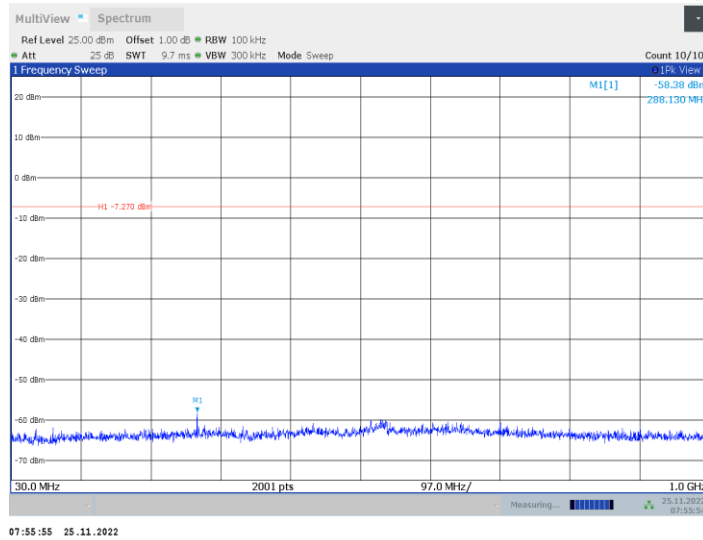

Unless otherwise agreed in writing, this document is issued by the Company subject to its General Conditions of Service printed overleaf, available on request or accessible at <http://www.sgs.com/en/Terms-and-Conditions.aspx> and, for electronic format documents, subject to Terms and Conditions for Electronic Documents at <http://www.sgs.com/en/Terms-and-Conditions/Terms-e-Documents.aspx>. Attention is drawn to the limitation of liability, indemnification and jurisdiction issues defined therein. Any holder of this document is advised that information contained hereon reflects the Company's findings at the time of its intervention only and within the limits of Client's instructions, if any. The Company's sole responsibility is to its Client and this document does not exonerate parties to a transaction from exercising all their rights and obligations under the transaction documents. This document cannot be reproduced except in full, without prior written approval of the Company. Any unauthorized alteration, forgery or falsification of the content or appearance of this document is unlawful and offenders may be prosecuted to the fullest extent of the law. Unless otherwise stated the results shown in this test report refer only to the sample(s) tested and such sample(s) are retained for 30 days only.

Attention: To check the authenticity of testing/inspection report & certificate, please contact us at telephone: (86-755) 8307 1443, or email: [CN.Doccheck@sgs.com](mailto:CN.Doccheck@sgs.com)

South of No. 6 Plant, No. 1, Runsheng Road, Suzhou Industrial Park, Suzhou Area, China (Jiangsu) Pilot Free Trade Zone 215000 t (86-512) 62992980 www.sgs.com.cn  
 中国·苏州·中国(江苏)自由贸易试验区苏州片区苏州工业园区润胜路1号的6号厂房南楼 邮编: 215000 t (86-512) 62992980 sgs.china@sgs.com

BLE 2M Ant1 2440 1000~26500

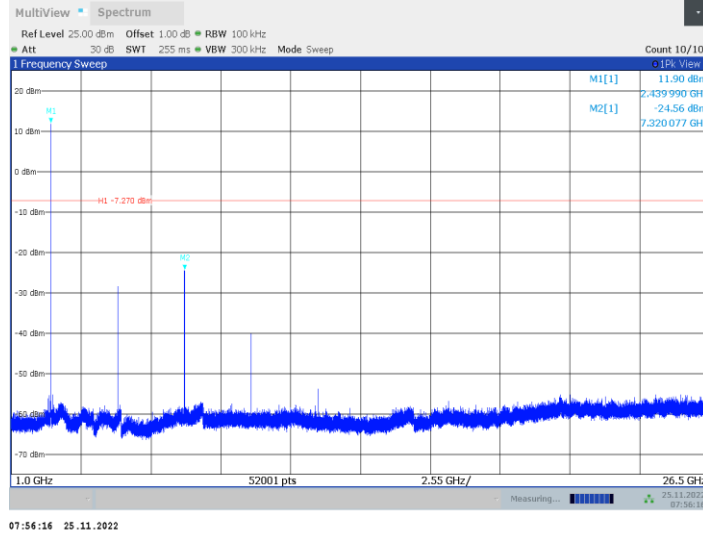

BLE 2M Ant1 2480 0~Reference

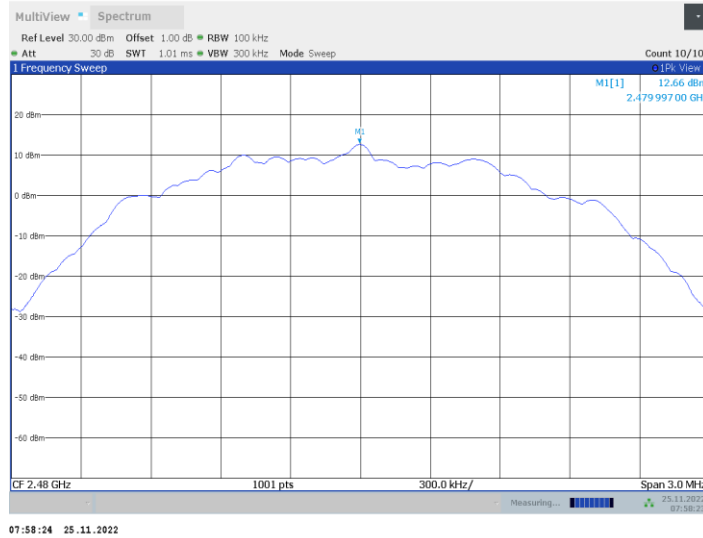

Unless otherwise agreed in writing, this document is issued by the Company subject to its General Conditions of Service printed overleaf, available on request or accessible at <http://www.sgs.com/en/Terms-and-Conditions.aspx> and, for electronic format documents, subject to Terms and Conditions for Electronic Documents at <http://www.sgs.com/en/Terms-and-Conditions/Terms-e-Documents.aspx>. Attention is drawn to the limitation of liability, indemnification and jurisdiction issues defined therein. Any holder of this document is advised that information contained hereon reflects the Company's findings at the time of its intervention only and within the limits of Client's instructions, if any. The Company's sole responsibility is to its Client and this document does not exonerate parties to a transaction from exercising all their rights and obligations under the transaction documents. This document cannot be reproduced except in full, without prior written approval of the Company. Any unauthorized alteration, forgery or falsification of the content or appearance of this document is unlawful and offenders may be prosecuted to the fullest extent of the law. Unless otherwise stated the results shown in this test report refer only to the sample(s) tested and such sample(s) are retained for 30 days only.  
**Attention: To check the authenticity of testing/inspection report & certificate, please contact us at telephone: (86-755) 8307 1443, or email: CN.Doccheck@sgs.com**  
 South of No. 6 Plant, No. 1, Runsheng Road, Suzhou Industrial Park, Suzhou Area, China (Jiangsu) Pilot Free Trade Zone 215000 t (86-512) 62992980 www.sgs.com.cn  
 中国·苏州·中国(江苏)自由贸易试验区苏州片区苏州工业园区润胜路1号的6号厂房南楼 邮编: 215000 t (86-512) 62992980 sgs.china@sgs.com

BLE\_2M\_Ant1\_2480\_30~1000

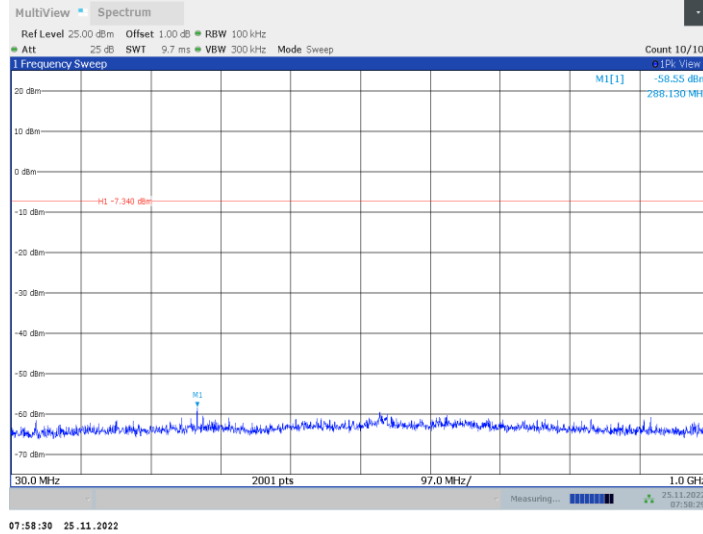

BLE\_2M\_Ant1\_2480\_1000~26500

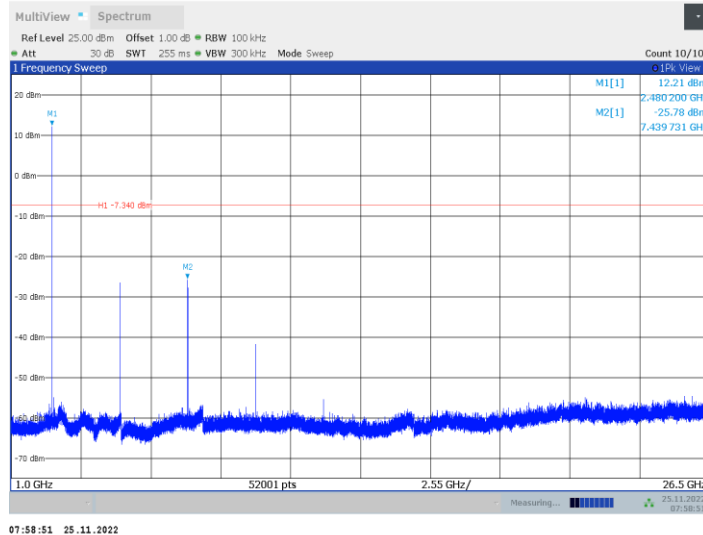

Unless otherwise agreed in writing, this document is issued by the Company subject to its General Conditions of Service printed overleaf, available on request or accessible at <http://www.sgs.com/en/Terms-and-Conditions.aspx> and, for electronic format documents, subject to Terms and Conditions for Electronic Documents at <http://www.sgs.com/en/Terms-and-Conditions/Terms-e-Documents.aspx>. Attention is drawn to the limitation of liability, indemnification and jurisdiction issues defined therein. Any holder of this document is advised that information contained hereon reflects the Company's findings at the time of its intervention only and within the limits of Client's instructions, if any. The Company's sole responsibility is to its Client and this document does not exonerate parties to a transaction from exercising all their rights and obligations under the transaction documents. This document cannot be reproduced except in full, without prior written approval of the Company. Any unauthorized alteration, forgery or falsification of the content or appearance of this document is unlawful and offenders may be prosecuted to the fullest extent of the law. Unless otherwise stated the results shown in this test report refer only to the sample(s) tested and such sample(s) are retained for 30 days only.

Attention: To check the authenticity of testing/inspection report & certificate, please contact us at telephone: (86-755) 8307 1443, or email: [CN.Doccheck@sgs.com](mailto:CN.Doccheck@sgs.com)

South of No. 6 Plant, No. 1, Runsheng Road, Suzhou Industrial Park, Suzhou Area, China (Jiangsu) Pilot Free Trade Zone 215000 t (86-512) 62992980 www.sgs.com.cn  
 中国·苏州·中国(江苏)自由贸易试验区苏州片区工业园区润胜路1号的6号厂房南部 邮编: 215000 t (86-512) 62992980 sgs.china@sgs.com

Report No.: SEWM2210000221RG04

Rev.: 01

Page: 56 of 79

### Duty Cycle Test Result

| TestMode | Antenna | Frequency[MHz] | ON Time [ms] | Period [ms] | Duty Cycle [%] | Duty Cycle Factor[dB] |
|----------|---------|----------------|--------------|-------------|----------------|-----------------------|
| BLE_1M   | Ant1    | 2402           | 0.39         | 0.63        | 61.90          | 2.08                  |
| BLE_2M   | Ant1    | 2402           | 0.20         | 0.62        | 32.26          | 4.91                  |



Unless otherwise agreed in writing, this document is issued by the Company subject to its General Conditions of Service printed overleaf, available on request or accessible at <http://www.sgs.com/en/Terms-and-Conditions.aspx> and, for electronic format documents, subject to Terms and Conditions for Electronic Documents at <http://www.sgs.com/en/Terms-and-Conditions/Terms-e-Documents.aspx>. Attention is drawn to the limitation of liability, indemnification and jurisdiction issues defined therein. Any holder of this document is advised that information contained hereon reflects the Company's findings at the time of its intervention only and within the limits of Client's instructions, if any. The Company's sole responsibility is to its Client and this document does not exonerate parties to a transaction from exercising all their rights and obligations under the transaction documents. This document cannot be reproduced except in full, without prior written approval of the Company. Any unauthorized alteration, forgery or falsification of the content or appearance of this document is unlawful and offenders may be prosecuted to the fullest extent of the law. Unless otherwise stated the results shown in this test report refer only to the sample(s) tested and such sample(s) are retained for 30 days only.  
**Attention: To check the authenticity of testing/inspection report & certificate, please contact us at telephone: (86-755) 8307 1443, or email: CN.Doccheck@sgs.com**

South of No. 6 Plant, No. 1, Runsheng Road, Suzhou Industrial Park, Suzhou Area, China (Jiangsu) Pilot Free Trade Zone 215000  
 中国·苏州·中国(江苏)自由贸易试验区苏州片区苏州工业园区润胜路1号的6号厂房南楼 邮编: 215000

t (86-512) 62992980 www.sgs.com.cn  
 t (86-512) 62992980 sgs.china@sgs.com



Test Graphs



Unless otherwise agreed in writing, this document is issued by the Company subject to its General Conditions of Service printed overleaf, available on request or accessible at <http://www.sgs.com/en/Terms-and-Conditions.aspx> and, for electronic format documents, subject to Terms and Conditions for Electronic Documents at <http://www.sgs.com/en/Terms-and-Conditions/Terms-e-Documents.aspx>. Attention is drawn to the limitation of liability, indemnification and jurisdiction issues defined therein. Any holder of this document is advised that information contained hereon reflects the Company's findings at the time of its intervention only and within the limits of Client's instructions, if any. The Company's sole responsibility is to its Client and this document does not exonerate parties to a transaction from exercising all their rights and obligations under the transaction documents. This document cannot be reproduced except in full, without prior written approval of the Company. Any unauthorized alteration, forgery or falsification of the content or appearance of this document is unlawful and offenders may be prosecuted to the fullest extent of the law. Unless otherwise stated the results shown in this test report refer only to the sample(s) tested and such sample(s) are retained for 30 days only.

Attention: To check the authenticity of testing/inspection report & certificate, please contact us at telephone: (86-755) 8307 1443, or email: [CN.Doccheck@sgs.com](mailto:CN.Doccheck@sgs.com)

South of No. 6 Plant, No. 1, Runsheng Road, Suzhou Industrial Park, Suzhou Area, China (Jiangsu) Pilot Free Trade Zone 215000 t (86-512) 62992980 www.sgs.com.cn  
 中国·苏州·中国(江苏)自由贸易试验区苏州片区工业园区润胜路1号的6号厂房南楼 邮编: 215000 t (86-512) 62992980 sgs.china@sgs.com

## Radiated Spurious Emissions

### Radiated emission below 1GHz

Worst case Mode: BLE 1M\_Channel 00

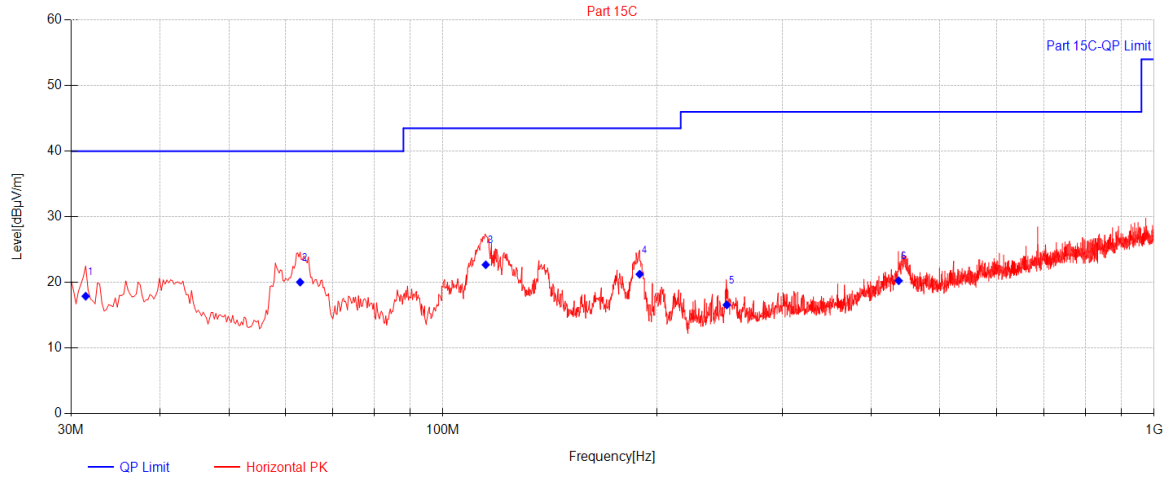

| Final Data List |                 |                |             |           |                   |                   |                |             |           |            |
|-----------------|-----------------|----------------|-------------|-----------|-------------------|-------------------|----------------|-------------|-----------|------------|
| NO.             | Frequency [MHz] | Reading [dBμV] | Factor [dB] | AF [dB/m] | QP Value [dBμV/m] | QP Limit [dBμV/m] | QP Margin [dB] | Height [cm] | Angle [°] | Polarity   |
| 1               | 31.455          | 41.25          | -36.64      | 13.27     | 17.88             | 40.00             | 22.12          | 213         | 1         | Horizontal |
| 2               | 62.98           | 44.29          | -36.44      | 12.17     | 20.03             | 40.00             | 19.97          | 254         | 287       | Horizontal |
| 3               | 114.875         | 47.16          | -36.15      | 11.67     | 22.68             | 43.50             | 20.82          | 169         | 91        | Horizontal |
| 4               | 189.08          | 44.13          | -35.40      | 12.51     | 21.24             | 43.50             | 22.26          | 158         | 245       | Horizontal |
| 5               | 250.675         | 39.23          | -34.27      | 11.59     | 16.55             | 46.00             | 29.45          | 153         | 91        | Horizontal |
| 6               | 437.4           | 38.11          | -33.53      | 15.66     | 20.24             | 46.00             | 25.76          | 199         | 214       | Horizontal |



Unless otherwise agreed in writing, this document is issued by the Company subject to its General Conditions of Service printed overleaf, available on request or accessible at <http://www.sgs.com/en/Terms-and-Conditions.aspx> and, for electronic format documents, subject to Terms and Conditions for Electronic Documents at <http://www.sgs.com/en/Terms-and-Conditions/Terms-e-Documents.aspx>. Attention is drawn to the limitation of liability, indemnification and jurisdiction issues defined therein. Any holder of this document is advised that information contained hereon reflects the Company's findings at the time of its intervention only and within the limits of Client's instructions, if any. The Company's sole responsibility is to its Client and this document does not exonerate parties to a transaction from exercising all their rights and obligations under the transaction documents. This document cannot be reproduced except in full, without prior written approval of the Company. Any unauthorized alteration, forgery or falsification of the content or appearance of this document is unlawful and offenders may be prosecuted to the fullest extent of the law. Unless otherwise stated the results shown in this test report refer only to the sample(s) tested and such sample(s) are retained for 30 days only.

Attention: To check the authenticity of testing/inspection report & certificate, please contact us at telephone: (86-755) 8307 1443, or email: [CN.Doccheck@sgs.com](mailto:CN.Doccheck@sgs.com)

South of No. 6 Plant, No. 1, Runsheng Road, Suzhou Industrial Park, Suzhou Area, China (Jiangsu) Pilot Free Trade Zone 215000  
 中国·苏州·中国(江苏)自由贸易试验区苏州片区苏州工业园区润胜路1号的6号厂房南楼 邮编: 215000

t (86-512) 62992980 www.sgsgroup.com.cn  
 t (86-512) 62992980 sgs.china@sgs.com

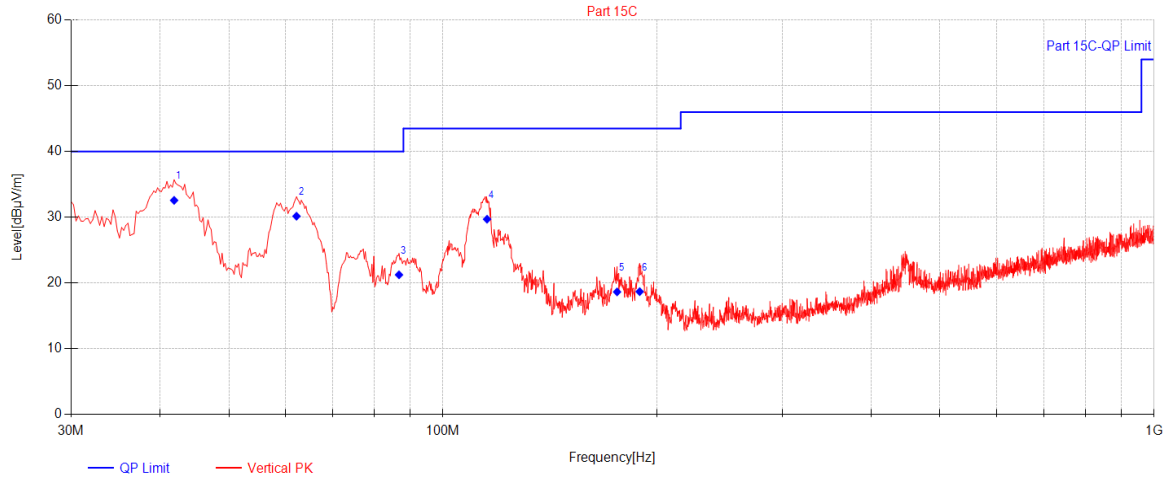

| Final Data List |                 |                |             |           |                   |                   |                |             |           |          |
|-----------------|-----------------|----------------|-------------|-----------|-------------------|-------------------|----------------|-------------|-----------|----------|
| NO.             | Frequency [MHz] | Reading [dBµV] | Factor [dB] | AF [dB/m] | QP Value [dBµV/m] | QP Limit [dBµV/m] | QP Margin [dB] | Height [cm] | Angle [°] | Polarity |
| 1               | 41.8825         | 54.89          | -36.25      | 13.91     | 32.56             | 40.00             | 7.44           | 245         | 237       | Vertical |
| 2               | 62.2525         | 54.26          | -36.43      | 12.32     | 30.15             | 40.00             | 9.85           | 184         | 268       | Vertical |
| 3               | 86.745          | 48.01          | -36.17      | 9.39      | 21.23             | 40.00             | 18.77          | 175         | 10        | Vertical |
| 4               | 115.36          | 54.13          | -36.15      | 11.72     | 29.70             | 43.50             | 13.80          | 135         | 338       | Vertical |
| 5               | 175.7425        | 39.26          | -35.19      | 14.57     | 18.63             | 43.50             | 24.87          | 199         | 144       | Vertical |
| 6               | 189.08          | 41.56          | -35.40      | 12.51     | 18.67             | 43.50             | 24.83          | 165         | 174       | Vertical |

Remark:

- The field strength is calculated by adding the Antenna Factor, Cable Factor & Preamplifier gain. The basic equation with a sample calculation is as follows:  
 Value = Reading(dBµV) + AF(dB/m) + Factor(dB)  
 AF = Antenna Factor(dB/m)  
 Factor = Cable Factor(dB) - Preamplifier gain(dB)  
 Margin = Limit(dBµV/m) – Value(dBµV/m)
- All channels have been tested, but only the worst case data displayed in this report.



Unless otherwise agreed in writing, this document is issued by the Company subject to its General Conditions of Service printed overleaf, available on request or accessible at <http://www.sgs.com/en/Terms-and-Conditions.aspx> and, for electronic format documents, subject to Terms and Conditions for Electronic Documents at <http://www.sgs.com/en/Terms-and-Conditions/Terms-e-Documents.aspx>. Attention is drawn to the limitation of liability, indemnification and jurisdiction issues defined therein. Any holder of this document is advised that information contained hereon reflects the Company's findings at the time of its intervention only and within the limits of Client's instructions, if any. The Company's sole responsibility is to its Client and this document does not exonerate parties to a transaction from exercising all their rights and obligations under the transaction documents. This document cannot be reproduced except in full, without prior written approval of the Company. Any unauthorized alteration, forgery or falsification of the content or appearance of this document is unlawful and offenders may be prosecuted to the fullest extent of the law. Unless otherwise stated the results shown in this test report refer only to the sample(s) tested and such sample(s) are retained for 30 days only.  
**Attention: To check the authenticity of testing/inspection report & certificate, please contact us at telephone: (86-755) 8307 1443, or email: CN.Doccheck@sgs.com**

South of No. 6 Plant, No. 1, Runsheng Road, Suzhou Industrial Park, Suzhou Area, China (Jiangsu) Pilot Free Trade Zone 215000 t (86-512) 62992980 www.sgs.com.cn  
 中国·苏州·中国(江苏)自由贸易试验区苏州片区苏州工业园区润胜路1号的6号厂房南楼 邮编: 215000 t (86-512) 62992980 sgs.china@sgs.com

### Transmitter emission Above 1GHz

#### BLE 1M\_Channel 00

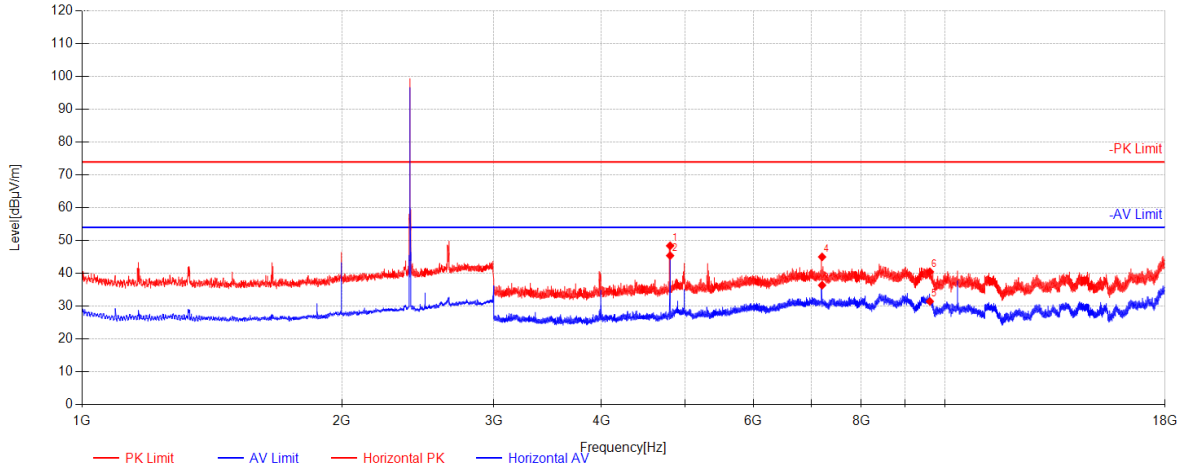

| Data List |                 |                |           |             |                |                |             |             |           |            |
|-----------|-----------------|----------------|-----------|-------------|----------------|----------------|-------------|-------------|-----------|------------|
| NO.       | Frequency [MHz] | Reading [dBµV] | AF [dB/m] | Factor [dB] | Level [dBµV/m] | Limit [dBµV/m] | Margin [dB] | Height [cm] | Angle [°] | Polarity   |
| 1         | 4804.0000       | 61.61          | 32.33     | -45.54      | 48.40          | 74.00          | 25.60       | 245         | 306       | Horizontal |
| 2         | 4804            | 58.62          | 32.33     | -45.54      | 45.41          | 54.00          | 8.59        | 165         | 55        | Horizontal |
| 3         | 7206.0000       | 43.21          | 36.60     | -43.44      | 36.37          | 54.00          | 17.63       | 125         | 28        | Horizontal |
| 4         | 7206.5          | 51.86          | 36.60     | -43.44      | 45.01          | 74.00          | 28.99       | 186         | 29        | Horizontal |
| 5         | 9608.0000       | 32.65          | 38.43     | -39.65      | 31.43          | 54.00          | 22.57       | 196         | 56        | Horizontal |
| 6         | 9608.0000       | 41.69          | 38.43     | -39.65      | 40.47          | 74.00          | 33.53       | 135         | 139       | Horizontal |



Unless otherwise agreed in writing, this document is issued by the Company subject to its General Conditions of Service printed overleaf, available on request or accessible at <http://www.sgs.com/en/Terms-and-Conditions.aspx> and, for electronic format documents, subject to Terms and Conditions for Electronic Documents at <http://www.sgs.com/en/Terms-and-Conditions/Terms-e-Documents.aspx>. Attention is drawn to the limitation of liability, indemnification and jurisdiction issues defined therein. Any holder of this document is advised that information contained hereon reflects the Company's findings at the time of its intervention only and within the limits of Client's instructions, if any. The Company's sole responsibility is to its Client and this document does not exonerate parties to a transaction from exercising all their rights and obligations under the transaction documents. This document cannot be reproduced except in full, without prior written approval of the Company. Any unauthorized alteration, forgery or falsification of the content or appearance of this document is unlawful and offenders may be prosecuted to the fullest extent of the law. Unless otherwise stated the results shown in this test report refer only to the sample(s) tested and such sample(s) are retained for 30 days only.

Attention: To check the authenticity of testing/inspection report & certificate, please contact us at telephone: (86-755) 8307 1443, or email: [CN.Doccheck@sgs.com](mailto:CN.Doccheck@sgs.com)

South of No. 6 Plant, No. 1, Runsheng Road, Suzhou Industrial Park, Suzhou Area, China (Jiangsu) Pilot Free Trade Zone 215000 t (86-512) 62992980 www.sgs.com.cn  
 中国·苏州·中国(江苏)自由贸易试验区苏州片区苏州工业园区润胜路1号的6号厂房南楼 邮编: 215000 t (86-512) 62992980 sgs.china@sgs.com

BLE 1M\_Channel 00

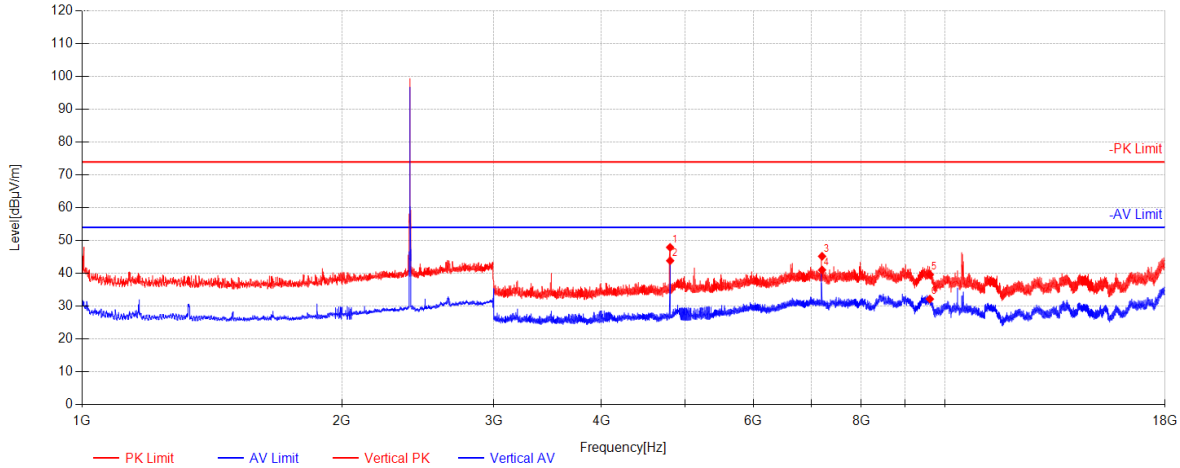

| Data List |                 |                |           |             |                |                |             |             |           |          |
|-----------|-----------------|----------------|-----------|-------------|----------------|----------------|-------------|-------------|-----------|----------|
| NO.       | Frequency [MHz] | Reading [dBµV] | AF [dB/m] | Factor [dB] | Level [dBµV/m] | Limit [dBµV/m] | Margin [dB] | Height [cm] | Angle [°] | Polarity |
| 1         | 4803.5          | 61.12          | 32.33     | -45.54      | 47.91          | 74.00          | 26.09       | 145         | 112       | Vertical |
| 2         | 4804.5          | 57.05          | 32.33     | -45.54      | 43.84          | 54.00          | 10.16       | 126         | 84        | Vertical |
| 3         | 7206.0000       | 52.03          | 36.60     | -43.44      | 45.19          | 74.00          | 28.81       | 185         | 84        | Vertical |
| 4         | 7206            | 47.87          | 36.60     | -43.44      | 41.03          | 54.00          | 12.97       | 174         | 168       | Vertical |
| 5         | 9608.0000       | 40.82          | 38.43     | -39.65      | 39.60          | 74.00          | 34.40       | 136         | 360       | Vertical |
| 6         | 9608.0000       | 33.37          | 38.43     | -39.65      | 32.15          | 54.00          | 21.85       | 259         | 167       | Vertical |



Unless otherwise agreed in writing, this document is issued by the Company subject to its General Conditions of Service printed overleaf, available on request or accessible at <http://www.sgs.com/en/Terms-and-Conditions.aspx> and, for electronic format documents, subject to Terms and Conditions for Electronic Documents at <http://www.sgs.com/en/Terms-and-Conditions/Terms-e-Documents.aspx>. Attention is drawn to the limitation of liability, indemnification and jurisdiction issues defined therein. Any holder of this document is advised that information contained hereon reflects the Company's findings at the time of its intervention only and within the limits of Client's instructions, if any. The Company's sole responsibility is to its Client and this document does not exonerate parties to a transaction from exercising all their rights and obligations under the transaction documents. This document cannot be reproduced except in full, without prior written approval of the Company. Any unauthorized alteration, forgery or falsification of the content or appearance of this document is unlawful and offenders may be prosecuted to the fullest extent of the law. Unless otherwise stated the results shown in this test report refer only to the sample(s) tested and such sample(s) are retained for 30 days only.  
**Attention: To check the authenticity of testing/inspection report & certificate, please contact us at telephone: (86-755) 83071443, or email: CN.Doccheck@sgs.com**

South of No. 6 Plant, No. 1, Runsheng Road, Suzhou Industrial Park, Suzhou Area, China (Jiangsu) Pilot Free Trade Zone 215000  
 中国·苏州·中国(江苏)自由贸易试验区苏州片区苏州工业园区润胜路1号的6号厂房南楼 邮编: 215000

t (86-512) 62992980 www.sgs.com.cn  
 t (86-512) 62992980 sgs.china@sgs.com

BLE 1M\_Channel 19

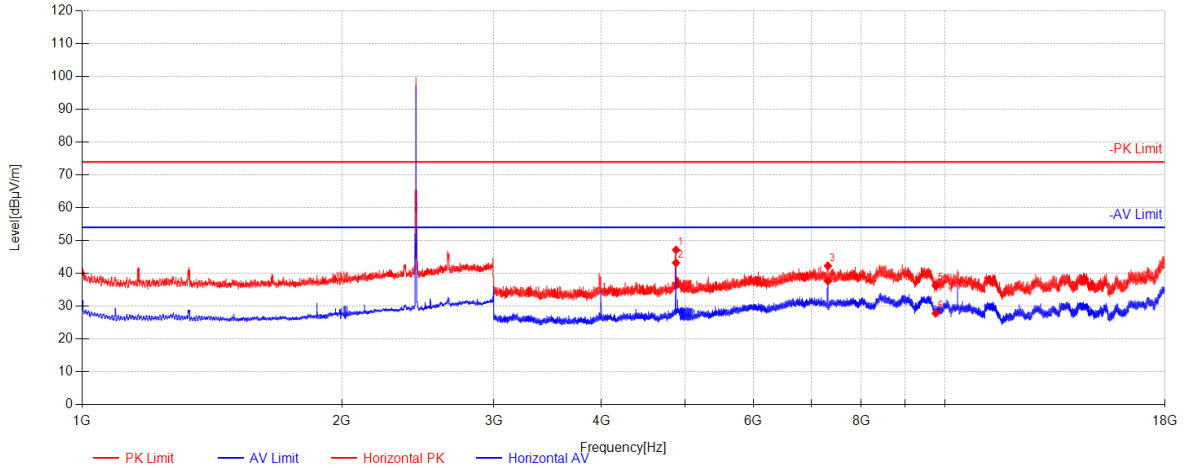

| Data List |                 |                |           |             |                |                |             |             |           |            |
|-----------|-----------------|----------------|-----------|-------------|----------------|----------------|-------------|-------------|-----------|------------|
| NO.       | Frequency [MHz] | Reading [dBµV] | AF [dB/m] | Factor [dB] | Level [dBµV/m] | Limit [dBµV/m] | Margin [dB] | Height [cm] | Angle [°] | Polarity   |
| 1         | 4880.0000       | 60.13          | 32.54     | -45.53      | 47.14          | 74.00          | 26.86       | 245         | 194       | Horizontal |
| 2         | 4880            | 56.21          | 32.54     | -45.53      | 43.22          | 54.00          | 10.78       | 186         | 29        | Horizontal |
| 3         | 7320.0000       | 49.42          | 36.53     | -43.68      | 42.27          | 74.00          | 31.73       | 136         | 281       | Horizontal |
| 4         | 7320.5          | 44.81          | 36.53     | -43.68      | 37.66          | 54.00          | 16.34       | 256         | 255       | Horizontal |
| 5         | 9760.0000       | 37.43          | 38.26     | -39.46      | 36.23          | 74.00          | 37.77       | 291         | 141       | Horizontal |
| 6         | 9760.0000       | 29.00          | 38.26     | -39.46      | 27.80          | 54.00          | 26.20       | 174         | 111       | Horizontal |



Unless otherwise agreed in writing, this document is issued by the Company subject to its General Conditions of Service printed overleaf, available on request or accessible at <http://www.sgs.com/en/Terms-and-Conditions.aspx> and, for electronic format documents, subject to Terms and Conditions for Electronic Documents at <http://www.sgs.com/en/Terms-and-Conditions/Terms-e-Documents.aspx>. Attention is drawn to the limitation of liability, indemnification and jurisdiction issues defined therein. Any holder of this document is advised that information contained hereon reflects the Company's findings at the time of its intervention only and within the limits of Client's instructions, if any. The Company's sole responsibility is to its Client and this document does not exonerate parties to a transaction from exercising all their rights and obligations under the transaction documents. This document cannot be reproduced except in full, without prior written approval of the Company. Any unauthorized alteration, forgery or falsification of the content or appearance of this document is unlawful and offenders may be prosecuted to the fullest extent of the law. Unless otherwise stated the results shown in this test report refer only to the sample(s) tested and such sample(s) are retained for 30 days only.  
**Attention: To check the authenticity of testing/inspection report & certificate, please contact us at telephone: (86-755) 8307 1443, or email: CN.Doccheck@sgs.com**

South of No. 6 Plant, No. 1, Runsheng Road, Suzhou Industrial Park, Suzhou Area, China (Jiangsu) Pilot Free Trade Zone 215000 t (86-512) 62992980 www.sgs.com.cn  
 中国·苏州·中国(江苏)自由贸易试验区苏州片区苏州工业园区润胜路1号的6号厂房南楼 邮编: 215000 t (86-512) 62992980 sgs.china@sgs.com

BLE 1M\_Channel 19

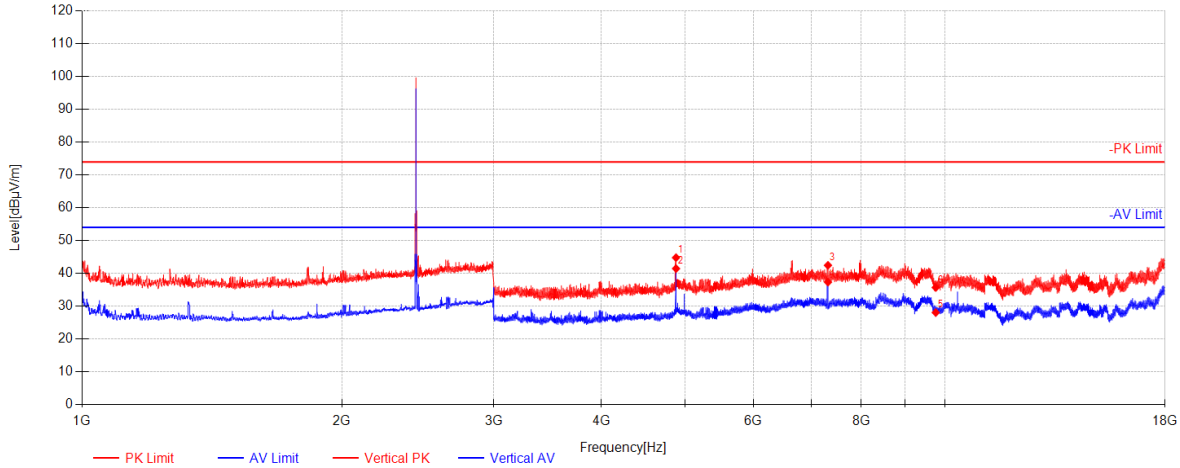

| Data List |                 |                |           |             |                |                |             |             |           |          |
|-----------|-----------------|----------------|-----------|-------------|----------------|----------------|-------------|-------------|-----------|----------|
| NO.       | Frequency [MHz] | Reading [dBµV] | AF [dB/m] | Factor [dB] | Level [dBµV/m] | Limit [dBµV/m] | Margin [dB] | Height [cm] | Angle [°] | Polarity |
| 1         | 4880.0000       | 57.78          | 32.54     | -45.53      | 44.79          | 74.00          | 29.21       | 145         | 335       | Vertical |
| 2         | 4880.5          | 54.44          | 32.55     | -45.53      | 41.45          | 54.00          | 12.55       | 185         | 335       | Vertical |
| 3         | 7320.0000       | 49.60          | 36.53     | -43.68      | 42.45          | 74.00          | 31.55       | 169         | 83        | Vertical |
| 4         | 7320.0000       | 44.48          | 36.53     | -43.68      | 37.33          | 54.00          | 16.67       | 192         | 254       | Vertical |
| 5         | 9760.0000       | 29.25          | 38.26     | -39.46      | 28.05          | 54.00          | 25.95       | 135         | 359       | Vertical |
| 6         | 9760.0000       | 36.88          | 38.26     | -39.46      | 35.68          | 74.00          | 38.32       | 175         | 83        | Vertical |



Unless otherwise agreed in writing, this document is issued by the Company subject to its General Conditions of Service printed overleaf, available on request or accessible at <http://www.sgs.com/en/Terms-and-Conditions.aspx> and, for electronic format documents, subject to Terms and Conditions for Electronic Documents at <http://www.sgs.com/en/Terms-and-Conditions/Terms-e-Documents.aspx>. Attention is drawn to the limitation of liability, indemnification and jurisdiction issues defined therein. Any holder of this document is advised that information contained hereon reflects the Company's findings at the time of its intervention only and within the limits of Client's instructions, if any. The Company's sole responsibility is to its Client and this document does not exonerate parties to a transaction from exercising all their rights and obligations under the transaction documents. This document cannot be reproduced except in full, without prior written approval of the Company. Any unauthorized alteration, forgery or falsification of the content or appearance of this document is unlawful and offenders may be prosecuted to the fullest extent of the law. Unless otherwise stated the results shown in this test report refer only to the sample(s) tested and such sample(s) are retained for 30 days only.  
**Attention: To check the authenticity of testing/inspection report & certificate, please contact us at telephone: (86-755) 8307 1443, or email: CN.Doccheck@sgs.com**

South of No. 6 Plant, No. 1, Runsheng Road, Suzhou Industrial Park, Suzhou Area, China (Jiangsu) Pilot Free Trade Zone 215000 t (86-512) 62992980 www.sgsgroup.com.cn  
 中国·苏州·中国(江苏)自由贸易试验区苏州片区苏州工业园区润胜路1号的6号厂房南楼 邮编: 215000 t (86-512) 62992980 sgs.china@sgs.com

BLE 1M\_Channel 39

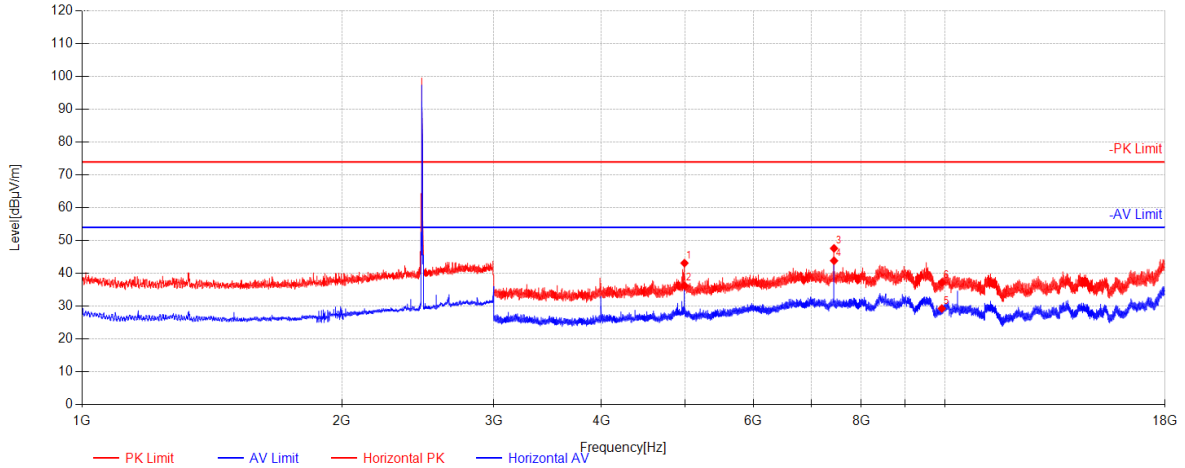

| Data List |                 |                |           |             |                |                |             |             |           |            |
|-----------|-----------------|----------------|-----------|-------------|----------------|----------------|-------------|-------------|-----------|------------|
| NO.       | Frequency [MHz] | Reading [dBµV] | AF [dB/m] | Factor [dB] | Level [dBµV/m] | Limit [dBµV/m] | Margin [dB] | Height [cm] | Angle [°] | Polarity   |
| 1         | 4991.5          | 55.89          | 32.86     | -45.63      | 43.12          | 74.00          | 30.88       | 245         | 249       | Horizontal |
| 2         | 4992.5          | 49.01          | 32.86     | -45.63      | 36.24          | 54.00          | 17.76       | 156         | 249       | Horizontal |
| 3         | 7440.0000       | 54.44          | 36.47     | -43.30      | 47.61          | 74.00          | 26.39       | 132         | 359       | Horizontal |
| 4         | 7440.5          | 50.67          | 36.47     | -43.30      | 43.84          | 54.00          | 10.16       | 158         | 359       | Horizontal |
| 5         | 9920.0000       | 30.20          | 38.38     | -39.31      | 29.27          | 54.00          | 24.73       | 196         | 222       | Horizontal |
| 6         | 9920.0000       | 38.14          | 38.38     | -39.31      | 37.21          | 74.00          | 36.79       | 187         | 277       | Horizontal |



Unless otherwise agreed in writing, this document is issued by the Company subject to its General Conditions of Service printed overleaf, available on request or accessible at <http://www.sgs.com/en/Terms-and-Conditions.aspx> and, for electronic format documents, subject to Terms and Conditions for Electronic Documents at <http://www.sgs.com/en/Terms-and-Conditions/Terms-e-Documents.aspx>. Attention is drawn to the limitation of liability, indemnification and jurisdiction issues defined therein. Any holder of this document is advised that information contained hereon reflects the Company's findings at the time of its intervention only and within the limits of Client's instructions, if any. The Company's sole responsibility is to its Client and this document does not exonerate parties to a transaction from exercising all their rights and obligations under the transaction documents. This document cannot be reproduced except in full, without prior written approval of the Company. Any unauthorized alteration, forgery or falsification of the content or appearance of this document is unlawful and offenders may be prosecuted to the fullest extent of the law. Unless otherwise stated the results shown in this test report refer only to the sample(s) tested and such sample(s) are retained for 30 days only.

Attention: To check the authenticity of testing/inspection report & certificate, please contact us at telephone: (86-755) 8307 1443, or email: [CN.Doccheck@sgs.com](mailto:CN.Doccheck@sgs.com)

South of No. 6 Plant, No. 1, Runsheng Road, Suzhou Industrial Park, Suzhou Area, China (Jiangsu) Pilot Free Trade Zone 215000 t (86-512) 62992980 www.sgs.com.cn  
 中国·苏州·中国(江苏)自由贸易试验区苏州片区苏州工业园区润胜路1号的6号厂房南楼 邮编: 215000 t (86-512) 62992980 sgs.china@sgs.com



BLE 1M\_Channel 39

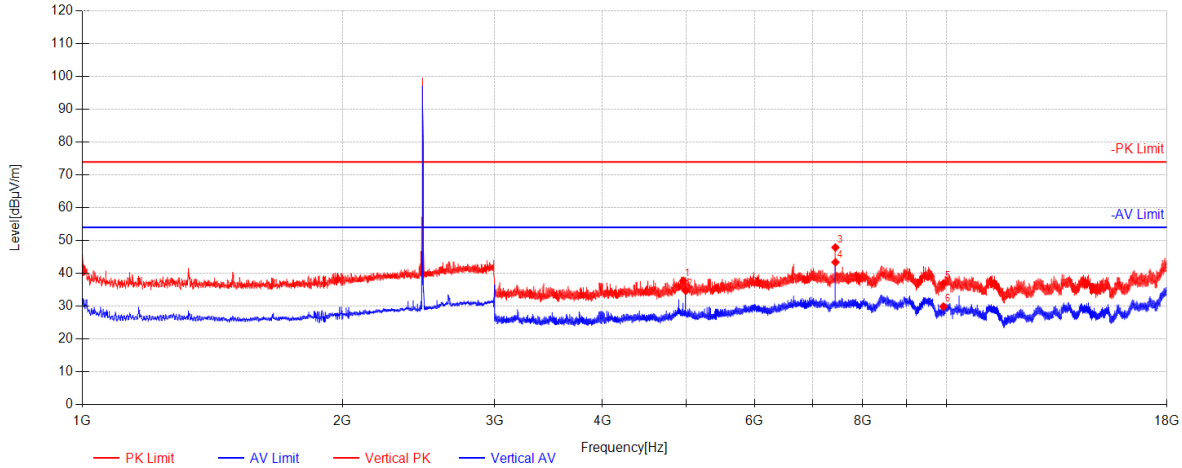

| Data List |                 |                |           |             |                |                |             |             |           |          |
|-----------|-----------------|----------------|-----------|-------------|----------------|----------------|-------------|-------------|-----------|----------|
| NO.       | Frequency [MHz] | Reading [dBµV] | AF [dB/m] | Factor [dB] | Level [dBµV/m] | Limit [dBµV/m] | Margin [dB] | Height [cm] | Angle [°] | Polarity |
| 1         | 4960.0000       | 50.57          | 32.77     | -45.60      | 37.74          | 74.00          | 36.26       | 245         | 359       | Vertical |
| 2         | 4992.5          | 47.44          | 32.86     | -45.63      | 34.67          | 54.00          | 19.33       | 123         | 280       | Vertical |
| 3         | 7440.0000       | 54.72          | 36.47     | -43.30      | 47.89          | 74.00          | 26.11       | 265         | 85        | Vertical |
| 4         | 7441            | 50.21          | 36.47     | -43.30      | 43.38          | 54.00          | 10.62       | 222         | 56        | Vertical |
| 5         | 9920.0000       | 37.83          | 38.38     | -39.31      | 36.90          | 74.00          | 37.10       | 124         | 196       | Vertical |
| 6         | 9920.0000       | 30.80          | 38.38     | -39.31      | 29.87          | 54.00          | 24.13       | 196         | 251       | Vertical |

Remark:

- The field strength is calculated by adding the Antenna Factor, Cable Factor & Preamplifier gain. The basic equation with a sample calculation is as follows:  
 $Level = Reading(dB\mu V) + AF(dB/m) + Factor(dB)$   
 $AF = Antenna\ Factor(dB/m)$   
 $Factor = Cable\ Factor(dB) - Preamplifier\ gain(dB)$   
 $Margin = Limit(dB\mu V/m) - Level(dB\mu V/m)$
- All channels have been tested, but only the worst case data displayed in this report.



Unless otherwise agreed in writing, this document is issued by the Company subject to its General Conditions of Service printed overleaf, available on request or accessible at <http://www.sgs.com/en/Terms-and-Conditions.aspx> and, for electronic format documents, subject to Terms and Conditions for Electronic Documents at <http://www.sgs.com/en/Terms-and-Conditions/Terms-e-Documents.aspx>. Attention is drawn to the limitation of liability, indemnification and jurisdiction issues defined therein. Any holder of this document is advised that information contained hereon reflects the Company's findings at the time of its intervention only and within the limits of Client's instructions, if any. The Company's sole responsibility is to its Client and this document does not exonerate parties to a transaction from exercising all their rights and obligations under the transaction documents. This document cannot be reproduced except in full, without prior written approval of the Company. Any unauthorized alteration, forgery or falsification of the content or appearance of this document is unlawful and offenders may be prosecuted to the fullest extent of the law. Unless otherwise stated the results shown in this test report refer only to the sample(s) tested and such sample(s) are retained for 30 days only.  
**Attention: To check the authenticity of testing/inspection report & certificate, please contact us at telephone: (86-755) 8307 1443, or email: CN.Doccheck@sgs.com**

South of No. 6 Plant, No. 1, Runsheng Road, Suzhou Industrial Park, Suzhou Area, China (Jiangsu) Pilot Free Trade Zone 215000 t (86-512) 62992980 www.sgsgroup.com.cn  
 中国·苏州·中国(江苏)自由贸易试验区苏州片区苏州工业园区润胜路1号的6号厂房南楼 邮编: 215000 t (86-512) 62992980 sgs.china@sgs.com

BLE 2M\_Channel 00

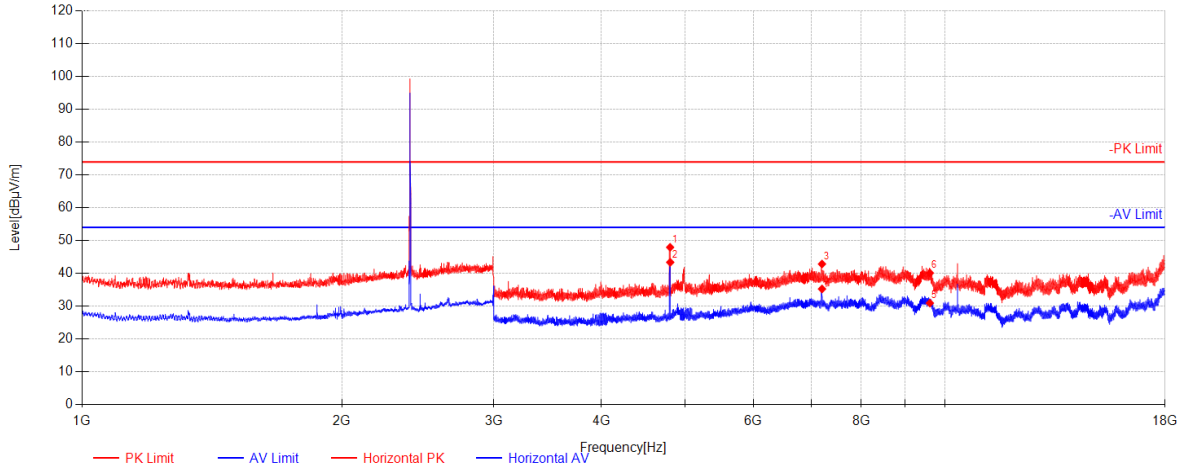

| Data List |                 |                |           |             |                |                |             |             |           |            |
|-----------|-----------------|----------------|-----------|-------------|----------------|----------------|-------------|-------------|-----------|------------|
| NO.       | Frequency [MHz] | Reading [dBµV] | AF [dB/m] | Factor [dB] | Level [dBµV/m] | Limit [dBµV/m] | Margin [dB] | Height [cm] | Angle [°] | Polarity   |
| 1         | 4804.0000       | 61.14          | 32.33     | -45.54      | 47.93          | 74.00          | 26.07       | 245         | 307       | Horizontal |
| 2         | 4805            | 56.58          | 32.33     | -45.54      | 43.37          | 54.00          | 10.63       | 126         | 307       | Horizontal |
| 3         | 7204.5          | 49.69          | 36.60     | -43.43      | 42.85          | 74.00          | 31.15       | 152         | 278       | Horizontal |
| 4         | 7205            | 42.07          | 36.60     | -43.44      | 35.23          | 54.00          | 18.77       | 136         | 28        | Horizontal |
| 5         | 9608.0000       | 32.14          | 38.43     | -39.65      | 30.92          | 54.00          | 23.08       | 258         | 28        | Horizontal |
| 6         | 9608.0000       | 41.32          | 38.43     | -39.65      | 40.10          | 74.00          | 33.90       | 196         | 252       | Horizontal |



Unless otherwise agreed in writing, this document is issued by the Company subject to its General Conditions of Service printed overleaf, available on request or accessible at <http://www.sgs.com/en/Terms-and-Conditions.aspx> and, for electronic format documents, subject to Terms and Conditions for Electronic Documents at <http://www.sgs.com/en/Terms-and-Conditions/Terms-e-Documents.aspx>. Attention is drawn to the limitation of liability, indemnification and jurisdiction issues defined therein. Any holder of this document is advised that information contained hereon reflects the Company's findings at the time of its intervention only and within the limits of Client's instructions, if any. The Company's sole responsibility is to its Client and this document does not exonerate parties to a transaction from exercising all their rights and obligations under the transaction documents. This document cannot be reproduced except in full, without prior written approval of the Company. Any unauthorized alteration, forgery or falsification of the content or appearance of this document is unlawful and offenders may be prosecuted to the fullest extent of the law. Unless otherwise stated the results shown in this test report refer only to the sample(s) tested and such sample(s) are retained for 30 days only.

Attention: To check the authenticity of testing/inspection report & certificate, please contact us at telephone: (86-755) 8307 1443, or email: [CN.Doccheck@sgs.com](mailto:CN.Doccheck@sgs.com)

South of No. 6 Plant, No. 1, Runsheng Road, Suzhou Industrial Park, Suzhou Area, China (Jiangsu) Pilot Free Trade Zone 215000 t (86-512) 62992980 www.sgs.com.cn  
 中国·苏州·中国(江苏)自由贸易试验区苏州片区苏州工业园区润胜路1号的6号厂房南楼 邮编: 215000 t (86-512) 62992980 sgs.china@sgs.com

BLE 2M\_Channel 00

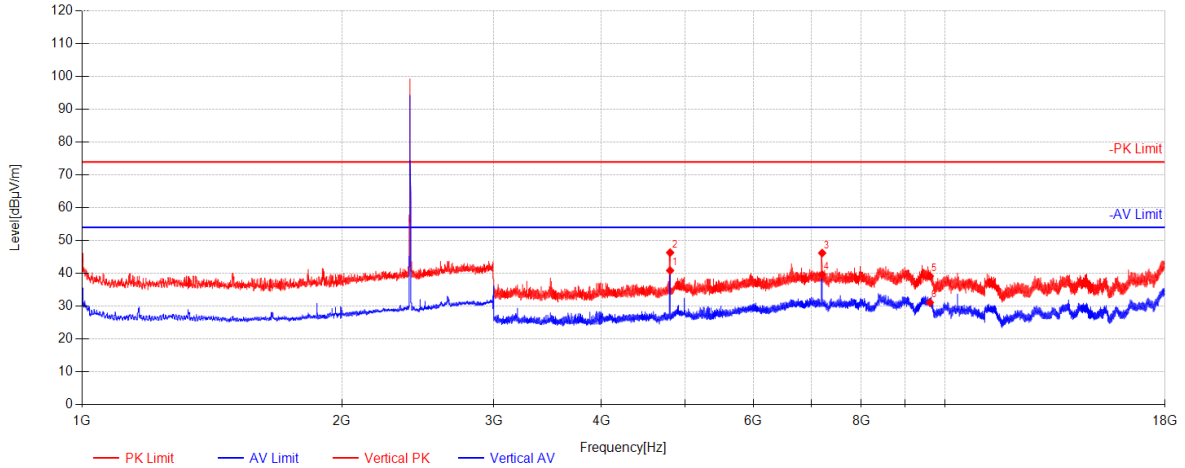

| Data List |                 |                |           |             |                |                |             |             |           |          |
|-----------|-----------------|----------------|-----------|-------------|----------------|----------------|-------------|-------------|-----------|----------|
| NO.       | Frequency [MHz] | Reading [dBµV] | AF [dB/m] | Factor [dB] | Level [dBµV/m] | Limit [dBµV/m] | Margin [dB] | Height [cm] | Angle [°] | Polarity |
| 1         | 4803.5          | 54.07          | 32.33     | -45.54      | 40.86          | 54.00          | 13.14       | 215         | 336       | Vertical |
| 2         | 4804.0000       | 59.53          | 32.33     | -45.54      | 46.32          | 74.00          | 27.68       | 136         | 112       | Vertical |
| 3         | 7207.5          | 53.04          | 36.60     | -43.44      | 46.19          | 74.00          | 27.81       | 258         | 81        | Vertical |
| 4         | 7207.5          | 46.44          | 36.60     | -43.44      | 39.59          | 54.00          | 14.41       | 174         | 55        | Vertical |
| 5         | 9608.0000       | 40.39          | 38.43     | -39.65      | 39.17          | 74.00          | 34.83       | 159         | 55        | Vertical |
| 6         | 9608.0000       | 32.32          | 38.43     | -39.65      | 31.10          | 54.00          | 22.90       | 136         | 359       | Vertical |



Unless otherwise agreed in writing, this document is issued by the Company subject to its General Conditions of Service printed overleaf, available on request or accessible at <http://www.sgs.com/en/Terms-and-Conditions.aspx> and, for electronic format documents, subject to Terms and Conditions for Electronic Documents at <http://www.sgs.com/en/Terms-and-Conditions/Terms-e-Documents.aspx>. Attention is drawn to the limitation of liability, indemnification and jurisdiction issues defined therein. Any holder of this document is advised that information contained hereon reflects the Company's findings at the time of its intervention only and within the limits of Client's instructions, if any. The Company's sole responsibility is to its Client and this document does not exonerate parties to a transaction from exercising all their rights and obligations under the transaction documents. This document cannot be reproduced except in full, without prior written approval of the Company. Any unauthorized alteration, forgery or falsification of the content or appearance of this document is unlawful and offenders may be prosecuted to the fullest extent of the law. Unless otherwise stated the results shown in this test report refer only to the sample(s) tested and such sample(s) are retained for 30 days only.

Attention: To check the authenticity of testing/inspection report & certificate, please contact us at telephone: (86-755) 8307 1443, or email: [CN.Doccheck@sgs.com](mailto:CN.Doccheck@sgs.com)

South of No. 6 Plant, No. 1, Runsheng Road, Suzhou Industrial Park, Suzhou Area, China (Jiangsu) Pilot Free Trade Zone 215000 t (86-512) 62992980 www.sgs.com.cn  
 中国·苏州·中国(江苏)自由贸易试验区苏州片区苏州工业园区润胜路1号的6号厂房南楼 邮编: 215000 t (86-512) 62992980 sgs.china@sgs.com

BLE 2M\_Channel 19

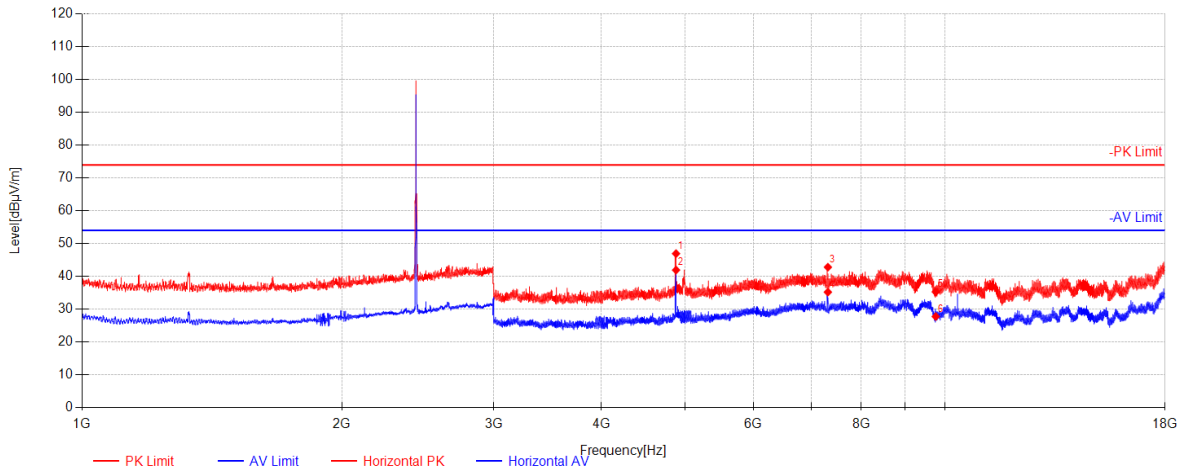

| Data List |                 |                |           |             |                |                |             |             |           |            |
|-----------|-----------------|----------------|-----------|-------------|----------------|----------------|-------------|-------------|-----------|------------|
| NO.       | Frequency [MHz] | Reading [dBµV] | AF [dB/m] | Factor [dB] | Level [dBµV/m] | Limit [dBµV/m] | Margin [dB] | Height [cm] | Angle [°] | Polarity   |
| 1         | 4880.0000       | 59.92          | 32.54     | -45.53      | 46.93          | 74.00          | 27.07       | 245         | 305       | Horizontal |
| 2         | 4880.5          | 54.91          | 32.55     | -45.53      | 41.92          | 54.00          | 12.08       | 136         | 305       | Horizontal |
| 3         | 7319            | 49.95          | 36.53     | -43.69      | 42.80          | 74.00          | 31.20       | 256         | 353       | Horizontal |
| 4         | 7319            | 42.34          | 36.53     | -43.69      | 35.19          | 54.00          | 18.81       | 199         | 4         | Horizontal |
| 5         | 9760.0000       | 36.46          | 38.26     | -39.46      | 35.26          | 74.00          | 38.74       | 184         | 279       | Horizontal |
| 6         | 9760.0000       | 28.94          | 38.26     | -39.46      | 27.74          | 54.00          | 26.26       | 175         | 360       | Horizontal |



Unless otherwise agreed in writing, this document is issued by the Company subject to its General Conditions of Service printed overleaf, available on request or accessible at <http://www.sgs.com/en/Terms-and-Conditions.aspx> and, for electronic format documents, subject to Terms and Conditions for Electronic Documents at <http://www.sgs.com/en/Terms-and-Conditions/Terms-e-Documents.aspx>. Attention is drawn to the limitation of liability, indemnification and jurisdiction issues defined therein. Any holder of this document is advised that information contained hereon reflects the Company's findings at the time of its intervention only and within the limits of Client's instructions, if any. The Company's sole responsibility is to its Client and this document does not exonerate parties to a transaction from exercising all their rights and obligations under the transaction documents. This document cannot be reproduced except in full, without prior written approval of the Company. Any unauthorized alteration, forgery or falsification of the content or appearance of this document is unlawful and offenders may be prosecuted to the fullest extent of the law. Unless otherwise stated the results shown in this test report refer only to the sample(s) tested and such sample(s) are retained for 30 days only.

Attention: To check the authenticity of testing/inspection report & certificate, please contact us at telephone: (86-755) 8307 1443, or email: [CN.Doccheck@sgs.com](mailto:CN.Doccheck@sgs.com)

South of No. 6 Plant, No. 1, Runsheng Road, Suzhou Industrial Park, Suzhou Area, China (Jiangsu) Pilot Free Trade Zone 215000  
 中国·苏州·中国(江苏)自由贸易试验区苏州片区苏州工业园区润胜路1号的6号厂房南楼 邮编: 215000

t (86-512) 62992980 www.sgs.com.cn  
 t (86-512) 62992980 sgs.china@sgs.com

BLE 2M\_Channel 19

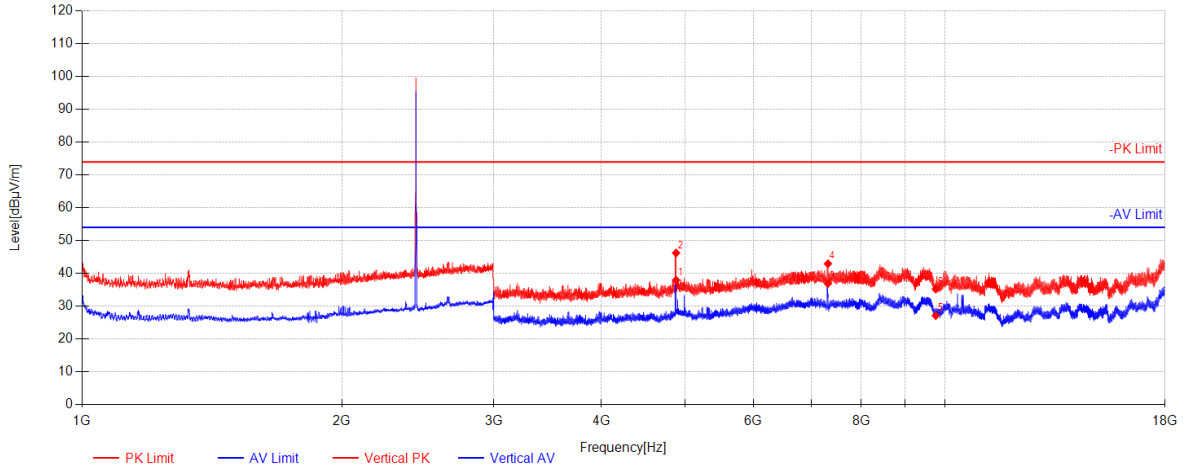

| Data List |                 |                |           |             |                |                |             |             |           |          |
|-----------|-----------------|----------------|-----------|-------------|----------------|----------------|-------------|-------------|-----------|----------|
| NO.       | Frequency [MHz] | Reading [dBµV] | AF [dB/m] | Factor [dB] | Level [dBµV/m] | Limit [dBµV/m] | Margin [dB] | Height [cm] | Angle [°] | Polarity |
| 1         | 4880.0000       | 50.90          | 32.54     | -45.53      | 37.91          | 54.00          | 16.09       | 248         | 84        | Vertical |
| 2         | 4881            | 59.19          | 32.55     | -45.53      | 46.20          | 74.00          | 27.80       | 153         | 84        | Vertical |
| 3         | 7319            | 44.03          | 36.53     | -43.69      | 36.88          | 54.00          | 17.12       | 133         | 84        | Vertical |
| 4         | 7320.0000       | 50.08          | 36.53     | -43.68      | 42.93          | 74.00          | 31.07       | 265         | 307       | Vertical |
| 5         | 9760.0000       | 28.32          | 38.26     | -39.46      | 27.12          | 54.00          | 26.88       | 145         | 112       | Vertical |
| 6         | 9760.0000       | 36.38          | 38.26     | -39.46      | 35.18          | 74.00          | 38.82       | 199         | 307       | Vertical |



Unless otherwise agreed in writing, this document is issued by the Company subject to its General Conditions of Service printed overleaf, available on request or accessible at <http://www.sgs.com/en/Terms-and-Conditions.aspx> and, for electronic format documents, subject to Terms and Conditions for Electronic Documents at <http://www.sgs.com/en/Terms-and-Conditions/Terms-e-Documents.aspx>. Attention is drawn to the limitation of liability, indemnification and jurisdiction issues defined therein. Any holder of this document is advised that information contained hereon reflects the Company's findings at the time of its intervention only and within the limits of Client's instructions, if any. The Company's sole responsibility is to its Client and this document does not exonerate parties to a transaction from exercising all their rights and obligations under the transaction documents. This document cannot be reproduced except in full, without prior written approval of the Company. Any unauthorized alteration, forgery or falsification of the content or appearance of this document is unlawful and offenders may be prosecuted to the fullest extent of the law. Unless otherwise stated the results shown in this test report refer only to the sample(s) tested and such sample(s) are retained for 30 days only.

Attention: To check the authenticity of testing/inspection report & certificate, please contact us at telephone: (86-755) 8307 1443, or email: [CN.Doccheck@sgs.com](mailto:CN.Doccheck@sgs.com)

South of No. 6 Plant, No. 1, Runsheng Road, Suzhou Industrial Park, Suzhou Area, China (Jiangsu) Pilot Free Trade Zone 215000 t (86-512) 62992980 www.sgs.com.cn  
 中国·苏州·中国(江苏)自由贸易试验区苏州片区苏州工业园区润胜路1号的6号厂房南楼 邮编: 215000 t (86-512) 62992980 sgs.china@sgs.com

BLE 2M\_Channel 39

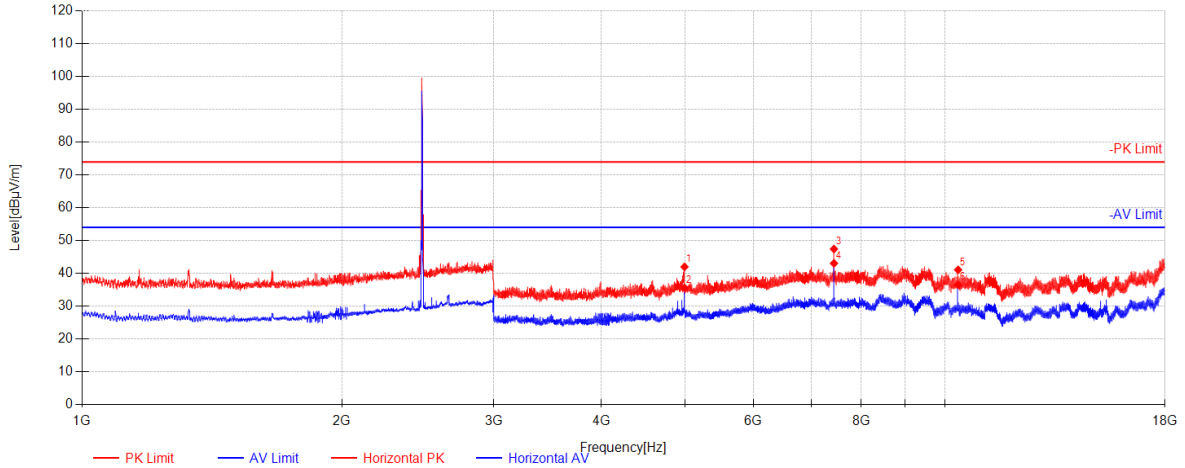

| Data List |                 |                |           |             |                |                |             |             |           |            |
|-----------|-----------------|----------------|-----------|-------------|----------------|----------------|-------------|-------------|-----------|------------|
| NO.       | Frequency [MHz] | Reading [dBµV] | AF [dB/m] | Factor [dB] | Level [dBµV/m] | Limit [dBµV/m] | Margin [dB] | Height [cm] | Angle [°] | Polarity   |
| 1         | 4992            | 54.75          | 32.86     | -45.63      | 41.98          | 74.00          | 32.02       | 245         | 251       | Horizontal |
| 2         | 4992.5          | 48.30          | 32.86     | -45.63      | 35.53          | 54.00          | 18.47       | 136         | 251       | Horizontal |
| 3         | 7438.5          | 54.26          | 36.47     | -43.31      | 47.42          | 74.00          | 26.58       | 258         | 359       | Horizontal |
| 4         | 7439            | 49.88          | 36.47     | -43.30      | 43.05          | 54.00          | 10.95       | 196         | 354       | Horizontal |
| 5         | 10360           | 41.26          | 38.85     | -39.04      | 41.07          | 74.00          | 32.93       | 174         | 55        | Horizontal |
| 6         | 10360.5         | 36.68          | 38.85     | -39.04      | 36.49          | 54.00          | 17.51       | 152         | 55        | Horizontal |



Unless otherwise agreed in writing, this document is issued by the Company subject to its General Conditions of Service printed overleaf, available on request or accessible at <http://www.sgs.com/en/Terms-and-Conditions.aspx> and, for electronic format documents, subject to Terms and Conditions for Electronic Documents at <http://www.sgs.com/en/Terms-and-Conditions/Terms-e-Documents.aspx>. Attention is drawn to the limitation of liability, indemnification and jurisdiction issues defined therein. Any holder of this document is advised that information contained hereon reflects the Company's findings at the time of its intervention only and within the limits of Client's instructions, if any. The Company's sole responsibility is to its Client and this document does not exonerate parties to a transaction from exercising all their rights and obligations under the transaction documents. This document cannot be reproduced except in full, without prior written approval of the Company. Any unauthorized alteration, forgery or falsification of the content or appearance of this document is unlawful and offenders may be prosecuted to the fullest extent of the law. Unless otherwise stated the results shown in this test report refer only to the sample(s) tested and such sample(s) are retained for 30 days only.

Attention: To check the authenticity of testing/inspection report & certificate, please contact us at telephone: (86-755) 8307 1443, or email: [CN.Doccheck@sgs.com](mailto:CN.Doccheck@sgs.com)

South of No. 6 Plant, No. 1, Runsheng Road, Suzhou Industrial Park, Suzhou Area, China (Jiangsu) Pilot Free Trade Zone 215000 t (86-512) 62992980 www.sgsgroup.com.cn  
 中国·苏州·中国(江苏)自由贸易试验区苏州片区苏州工业园区润胜路1号的6号厂房南楼 邮编: 215000 t (86-512) 62992980 sgs.china@sgs.com

BLE 2M\_Channel 39

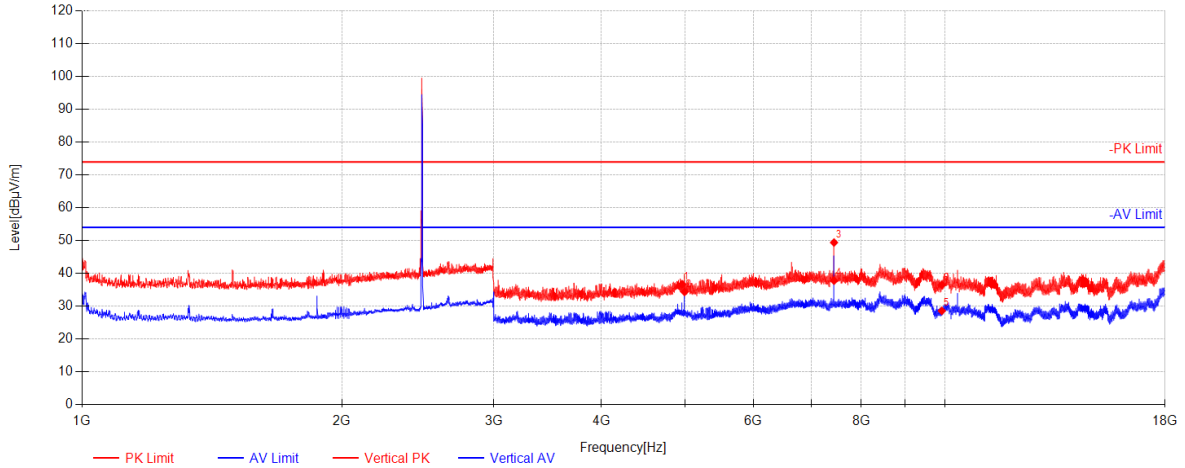

| Data List |                 |                |           |             |                |                |             |             |           |          |
|-----------|-----------------|----------------|-----------|-------------|----------------|----------------|-------------|-------------|-----------|----------|
| NO.       | Frequency [MHz] | Reading [dBµV] | AF [dB/m] | Factor [dB] | Level [dBµV/m] | Limit [dBµV/m] | Margin [dB] | Height [cm] | Angle [°] | Polarity |
| 1         | 4960.0000       | 49.51          | 32.77     | -45.60      | 36.68          | 74.00          | 37.32       | 245         | 360       | Vertical |
| 2         | 4992.5          | 47.11          | 32.86     | -45.63      | 34.34          | 54.00          | 19.66       | 136         | 281       | Vertical |
| 3         | 7440.0000       | 56.23          | 36.47     | -43.30      | 49.40          | 74.00          | 24.60       | 258         | 84        | Vertical |
| 4         | 7440.0000       | 44.60          | 36.47     | -43.30      | 37.77          | 54.00          | 16.23       | 196         | 252       | Vertical |
| 5         | 9920.0000       | 29.49          | 38.38     | -39.31      | 28.56          | 54.00          | 25.44       | 175         | 4         | Vertical |
| 6         | 9920.0000       | 37.39          | 38.38     | -39.31      | 36.46          | 74.00          | 37.54       | 142         | 197       | Vertical |



Unless otherwise agreed in writing, this document is issued by the Company subject to its General Conditions of Service printed overleaf, available on request or accessible at <http://www.sgs.com/en/Terms-and-Conditions.aspx> and, for electronic format documents, subject to Terms and Conditions for Electronic Documents at <http://www.sgs.com/en/Terms-and-Conditions/Terms-e-Documents.aspx>. Attention is drawn to the limitation of liability, indemnification and jurisdiction issues defined therein. Any holder of this document is advised that information contained hereon reflects the Company's findings at the time of its intervention only and within the limits of Client's instructions, if any. The Company's sole responsibility is to its Client and this document does not exonerate parties to a transaction from exercising all their rights and obligations under the transaction documents. This document cannot be reproduced except in full, without prior written approval of the Company. Any unauthorized alteration, forgery or falsification of the content or appearance of this document is unlawful and offenders may be prosecuted to the fullest extent of the law. Unless otherwise stated the results shown in this test report refer only to the sample(s) tested and such sample(s) are retained for 30 days only.  
**Attention: To check the authenticity of testing/inspection report & certificate, please contact us at telephone: (86-755) 83071443, or email: CN.Doccheck@sgs.com**

South of No. 6 Plant, No. 1, Runsheng Road, Suzhou Industrial Park, Suzhou Area, China (Jiangsu) Pilot Free Trade Zone 215000 t (86-512) 62992980 www.sgs.com.cn  
 中国·苏州·中国(江苏)自由贸易试验区苏州片区苏州工业园区润胜路1号的6号厂房南楼 邮编: 215000 t (86-512) 62992980 sgs.china@sgs.com

### Restricted bands around fundamental frequency

#### BLE 1M\_Channel 00

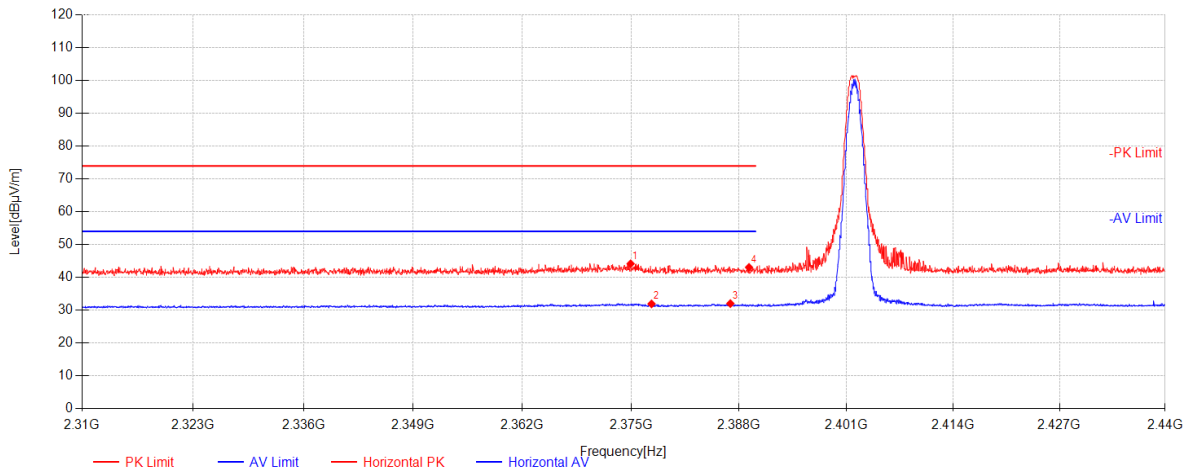

| Data List |                 |                |           |             |                |                |             |             |           |            |
|-----------|-----------------|----------------|-----------|-------------|----------------|----------------|-------------|-------------|-----------|------------|
| NO.       | Frequency [MHz] | Reading [dBµV] | AF [dB/m] | Factor [dB] | Level [dBµV/m] | Limit [dBµV/m] | Margin [dB] | Height [cm] | Angle [°] | Polarity   |
| 1         | 2374.9567       | 40.30          | 27.43     | -23.57      | 44.15          | 74.00          | 29.85       | 145         | 226       | Horizontal |
| 2         | 2377.47         | 28.04          | 27.43     | -23.57      | 31.90          | 54.00          | 22.10       | 145         | 226       | Horizontal |
| 3         | 2386.96         | 28.14          | 27.43     | -23.57      | 32.00          | 54.00          | 22.00       | 145         | 226       | Horizontal |
| 4         | 2389.2133       | 39.18          | 27.43     | -23.57      | 43.04          | 74.00          | 30.96       | 145         | 226       | Horizontal |



Unless otherwise agreed in writing, this document is issued by the Company subject to its General Conditions of Service printed overleaf, available on request or accessible at <http://www.sgs.com/en/Terms-and-Conditions.aspx> and, for electronic format documents, subject to Terms and Conditions for Electronic Documents at <http://www.sgs.com/en/Terms-and-Conditions/Terms-e-Documents.aspx>. Attention is drawn to the limitation of liability, indemnification and jurisdiction issues defined therein. Any holder of this document is advised that information contained hereon reflects the Company's findings at the time of its intervention only and within the limits of Client's instructions, if any. The Company's sole responsibility is to its Client and this document does not exonerate parties to a transaction from exercising all their rights and obligations under the transaction documents. This document cannot be reproduced except in full, without prior written approval of the Company. Any unauthorized alteration, forgery or falsification of the content or appearance of this document is unlawful and offenders may be prosecuted to the fullest extent of the law. Unless otherwise stated the results shown in this test report refer only to the sample(s) tested and such sample(s) are retained for 30 days only.

Attention: To check the authenticity of testing/inspection report & certificate, please contact us at telephone: (86-755) 8307 1443, or email: [CN.Doccheck@sgs.com](mailto:CN.Doccheck@sgs.com)

South of No. 6 Plant, No. 1, Runsheng Road, Suzhou Industrial Park, Suzhou Area, China (Jiangsu) Pilot Free Trade Zone 215000  
 中国·苏州·中国(江苏)自由贸易试验区苏州片区苏州工业园区润胜路1号的6号厂房南楼 邮编: 215000

t (86-512) 62992980 www.sgsgroup.com.cn  
 t (86-512) 62992980 sgs.china@sgs.com



BLE 1M\_Channel 00

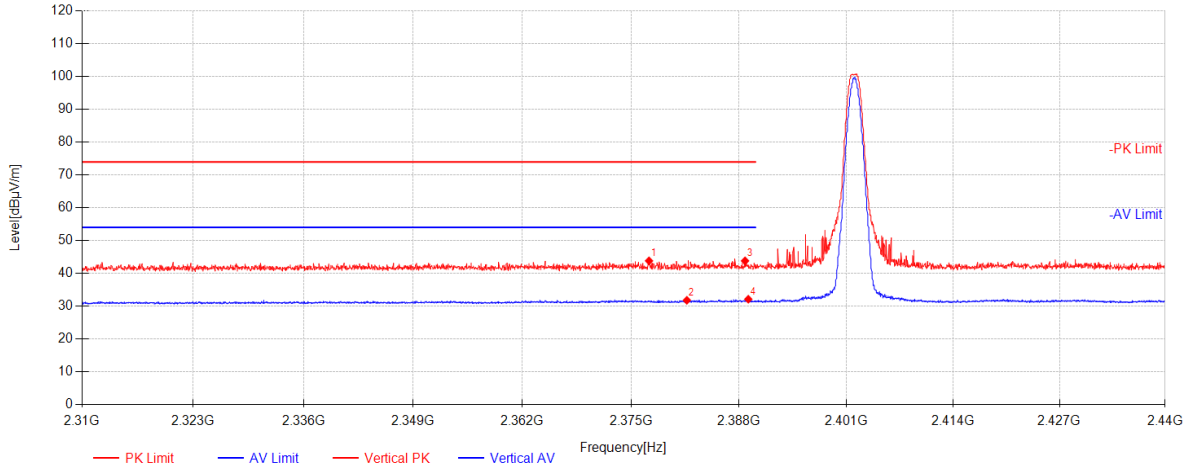

| Data List |                 |                |           |             |                |                |             |             |           |          |
|-----------|-----------------|----------------|-----------|-------------|----------------|----------------|-------------|-------------|-----------|----------|
| NO.       | Frequency [MHz] | Reading [dBµV] | AF [dB/m] | Factor [dB] | Level [dBµV/m] | Limit [dBµV/m] | Margin [dB] | Height [cm] | Angle [°] | Polarity |
| 1         | 2377.1667       | 39.95          | 27.43     | -23.57      | 43.81          | 74.00          | 30.19       | 178         | 281       | Vertical |
| 2         | 2381.7167       | 27.92          | 27.43     | -23.57      | 31.78          | 54.00          | 22.22       | 178         | 281       | Vertical |
| 3         | 2388.7367       | 39.94          | 27.43     | -23.57      | 43.80          | 74.00          | 30.20       | 178         | 281       | Vertical |
| 4         | 2389.1267       | 28.25          | 27.43     | -23.57      | 32.11          | 54.00          | 21.89       | 178         | 281       | Vertical |



Unless otherwise agreed in writing, this document is issued by the Company subject to its General Conditions of Service printed overleaf, available on request or accessible at <http://www.sgs.com/en/Terms-and-Conditions.aspx> and, for electronic format documents, subject to Terms and Conditions for Electronic Documents at <http://www.sgs.com/en/Terms-and-Conditions/Terms-e-Documents.aspx>. Attention is drawn to the limitation of liability, indemnification and jurisdiction issues defined therein. Any holder of this document is advised that information contained hereon reflects the Company's findings at the time of its intervention only and within the limits of Client's instructions, if any. The Company's sole responsibility is to its Client and this document does not exonerate parties to a transaction from exercising all their rights and obligations under the transaction documents. This document cannot be reproduced except in full, without prior written approval of the Company. Any unauthorized alteration, forgery or falsification of the content or appearance of this document is unlawful and offenders may be prosecuted to the fullest extent of the law. Unless otherwise stated the results shown in this test report refer only to the sample(s) tested and such sample(s) are retained for 30 days only.

Attention: To check the authenticity of testing/inspection report & certificate, please contact us at telephone: (86-755) 8307 1443, or email: [CN.Doccheck@sgs.com](mailto:CN.Doccheck@sgs.com)

South of No. 6 Plant, No. 1, Runsheng Road, Suzhou Industrial Park, Suzhou Area, China (Jiangsu) Pilot Free Trade Zone 215000 t (86-512) 62992980 www.sgs.com.cn  
 中国·苏州·中国(江苏)自由贸易试验区苏州片区苏州工业园区润胜路1号的6号厂房南楼 邮编: 215000 t (86-512) 62992980 sgs.china@sgs.com

BLE 1M\_Channel 39

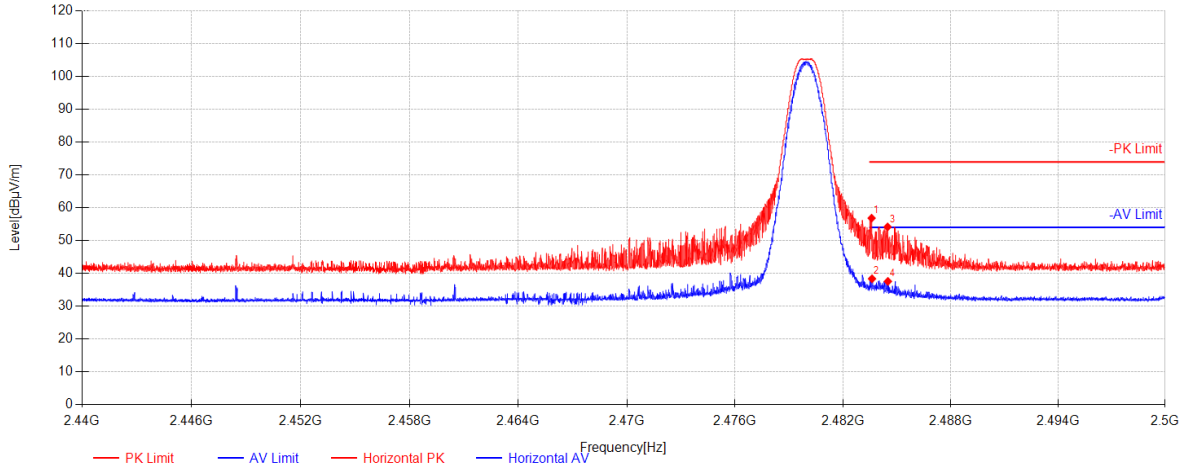

| Data List |                 |                |           |             |                |                |             |             |           |            |
|-----------|-----------------|----------------|-----------|-------------|----------------|----------------|-------------|-------------|-----------|------------|
| NO.       | Frequency [MHz] | Reading [dBµV] | AF [dB/m] | Factor [dB] | Level [dBµV/m] | Limit [dBµV/m] | Margin [dB] | Height [cm] | Angle [°] | Polarity   |
| 1         | 2483.5975       | 52.66          | 27.72     | -23.54      | 56.83          | 74.00          | 17.17       | 225         | 191       | Horizontal |
| 2         | 2483.62         | 34.18          | 27.72     | -23.54      | 38.35          | 54.00          | 15.65       | 225         | 191       | Horizontal |
| 3         | 2484.49         | 49.99          | 27.72     | -23.54      | 54.16          | 74.00          | 19.84       | 225         | 191       | Horizontal |
| 4         | 2484.505        | 33.38          | 27.72     | -23.54      | 37.55          | 54.00          | 16.45       | 225         | 191       | Horizontal |



Unless otherwise agreed in writing, this document is issued by the Company subject to its General Conditions of Service printed overleaf, available on request or accessible at <http://www.sgs.com/en/Terms-and-Conditions.aspx> and, for electronic format documents, subject to Terms and Conditions for Electronic Documents at <http://www.sgs.com/en/Terms-and-Conditions/Terms-e-Documents.aspx>. Attention is drawn to the limitation of liability, indemnification and jurisdiction issues defined therein. Any holder of this document is advised that information contained hereon reflects the Company's findings at the time of its intervention only and within the limits of Client's instructions, if any. The Company's sole responsibility is to its Client and this document does not exonerate parties to a transaction from exercising all their rights and obligations under the transaction documents. This document cannot be reproduced except in full, without prior written approval of the Company. Any unauthorized alteration, forgery or falsification of the content or appearance of this document is unlawful and offenders may be prosecuted to the fullest extent of the law. Unless otherwise stated the results shown in this test report refer only to the sample(s) tested and such sample(s) are retained for 30 days only.

Attention: To check the authenticity of testing/inspection report & certificate, please contact us at telephone: (86-755) 8307 1443, or email: [CN.Doccheck@sgs.com](mailto:CN.Doccheck@sgs.com)

South of No. 6 Plant, No. 1, Runsheng Road, Suzhou Industrial Park, Suzhou Area, China (Jiangsu) Pilot Free Trade Zone 215000 t (86-512) 62992980 www.sgsgroup.com.cn  
 中国·苏州·中国(江苏)自由贸易试验区苏州片区苏州工业园区润胜路1号的6号厂房南楼 邮编: 215000 t (86-512) 62992980 sgs.china@sgs.com

BLE 1M\_Channel 39

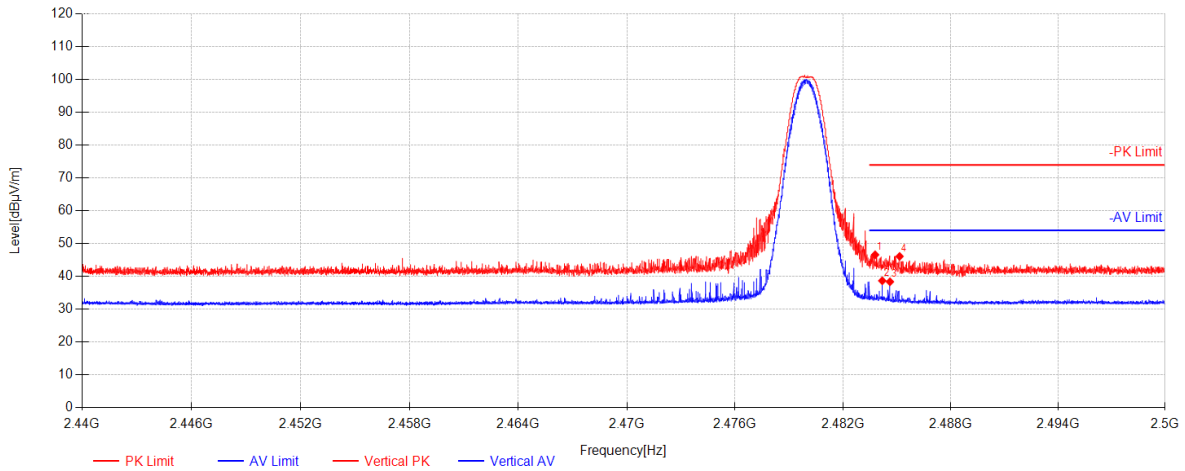

| Data List |                 |                |           |             |                |                |             |             |           |          |
|-----------|-----------------|----------------|-----------|-------------|----------------|----------------|-------------|-------------|-----------|----------|
| NO.       | Frequency [MHz] | Reading [dBµV] | AF [dB/m] | Factor [dB] | Level [dBµV/m] | Limit [dBµV/m] | Margin [dB] | Height [cm] | Angle [°] | Polarity |
| 1         | 2483.7925       | 42.40          | 27.72     | -23.54      | 46.57          | 74.00          | 27.43       | 236         | 43        | Vertical |
| 2         | 2484.19         | 34.48          | 27.72     | -23.54      | 38.65          | 54.00          | 15.35       | 236         | 43        | Vertical |
| 3         | 2484.6175       | 34.18          | 27.72     | -23.54      | 38.35          | 54.00          | 15.65       | 236         | 43        | Vertical |
| 4         | 2485.1575       | 41.91          | 27.72     | -23.54      | 46.09          | 74.00          | 27.91       | 236         | 43        | Vertical |



Unless otherwise agreed in writing, this document is issued by the Company subject to its General Conditions of Service printed overleaf, available on request or accessible at <http://www.sgs.com/en/Terms-and-Conditions.aspx> and, for electronic format documents, subject to Terms and Conditions for Electronic Documents at <http://www.sgs.com/en/Terms-and-Conditions/Terms-e-Documents.aspx>. Attention is drawn to the limitation of liability, indemnification and jurisdiction issues defined therein. Any holder of this document is advised that information contained hereon reflects the Company's findings at the time of its intervention only and within the limits of Client's instructions, if any. The Company's sole responsibility is to its Client and this document does not exonerate parties to a transaction from exercising all their rights and obligations under the transaction documents. This document cannot be reproduced except in full, without prior written approval of the Company. Any unauthorized alteration, forgery or falsification of the content or appearance of this document is unlawful and offenders may be prosecuted to the fullest extent of the law. Unless otherwise stated the results shown in this test report refer only to the sample(s) tested and such sample(s) are retained for 30 days only.

Attention: To check the authenticity of testing/inspection report & certificate, please contact us at telephone: (86-755) 8307 1443, or email: [CN.Doccheck@sgs.com](mailto:CN.Doccheck@sgs.com)

South of No. 6 Plant, No. 1, Runsheng Road, Suzhou Industrial Park, Suzhou Area, China (Jiangsu) Pilot Free Trade Zone 215000  
 中国·苏州·中国(江苏)自由贸易试验区苏州片区苏州工业园区润胜路1号的6号厂房南楼 邮编: 215000

t (86-512) 62992980 www.sgsgroup.com.cn  
 t (86-512) 62992980 sgs.china@sgs.com

BLE 2M\_Channel 00

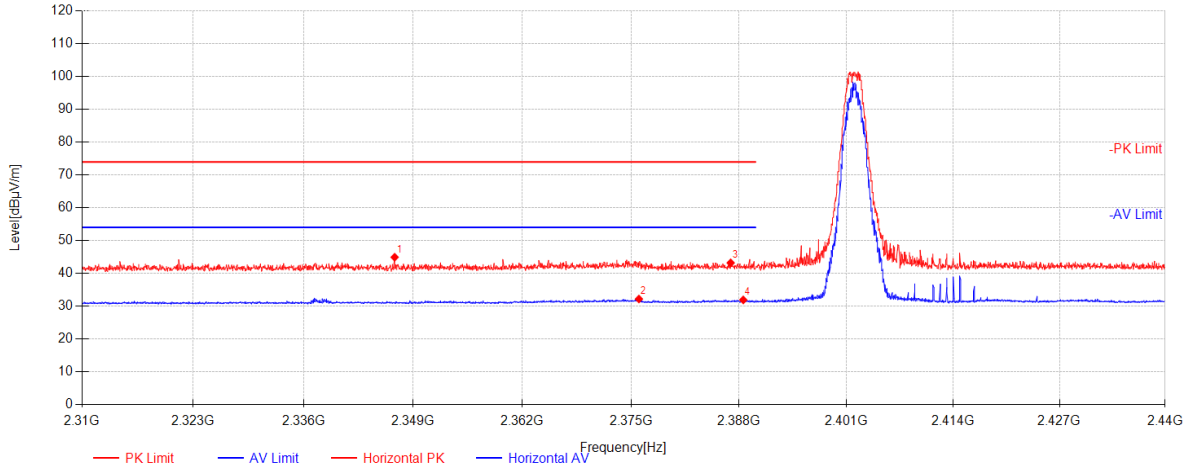

| Data List |                 |                |           |             |                |                |             |             |           |            |
|-----------|-----------------|----------------|-----------|-------------|----------------|----------------|-------------|-------------|-----------|------------|
| NO.       | Frequency [MHz] | Reading [dBµV] | AF [dB/m] | Factor [dB] | Level [dBµV/m] | Limit [dBµV/m] | Margin [dB] | Height [cm] | Angle [°] | Polarity   |
| 1         | 2346.79         | 41.07          | 27.41     | -23.58      | 44.91          | 74.00          | 29.09       | 169         | 213       | Horizontal |
| 2         | 2375.9533       | 28.32          | 27.43     | -23.57      | 32.18          | 54.00          | 21.82       | 169         | 213       | Horizontal |
| 3         | 2387.0033       | 39.33          | 27.43     | -23.57      | 43.19          | 74.00          | 30.81       | 169         | 213       | Horizontal |
| 4         | 2388.52         | 28.03          | 27.43     | -23.57      | 31.89          | 54.00          | 22.11       | 169         | 213       | Horizontal |



Unless otherwise agreed in writing, this document is issued by the Company subject to its General Conditions of Service printed overleaf, available on request or accessible at <http://www.sgs.com/en/Terms-and-Conditions.aspx> and, for electronic format documents, subject to Terms and Conditions for Electronic Documents at <http://www.sgs.com/en/Terms-and-Conditions/Terms-e-Documents.aspx>. Attention is drawn to the limitation of liability, indemnification and jurisdiction issues defined therein. Any holder of this document is advised that information contained hereon reflects the Company's findings at the time of its intervention only and within the limits of Client's instructions, if any. The Company's sole responsibility is to its Client and this document does not exonerate parties to a transaction from exercising all their rights and obligations under the transaction documents. This document cannot be reproduced except in full, without prior written approval of the Company. Any unauthorized alteration, forgery or falsification of the content or appearance of this document is unlawful and offenders may be prosecuted to the fullest extent of the law. Unless otherwise stated the results shown in this test report refer only to the sample(s) tested and such sample(s) are retained for 30 days only.

Attention: To check the authenticity of testing/inspection report & certificate, please contact us at telephone: (86-755) 8307 1443, or email: [CN.Doccheck@sgs.com](mailto:CN.Doccheck@sgs.com)

South of No. 6 Plant, No. 1, Runsheng Road, Suzhou Industrial Park, Suzhou Area, China (Jiangsu) Pilot Free Trade Zone 215000 t (86-512) 62992980 www.sgs.com.cn  
 中国·苏州·中国(江苏)自由贸易试验区苏州片区苏州工业园区润胜路1号的6号厂房南楼 邮编: 215000 t (86-512) 62992980 sgs.china@sgs.com

BLE 2M\_Channel 00

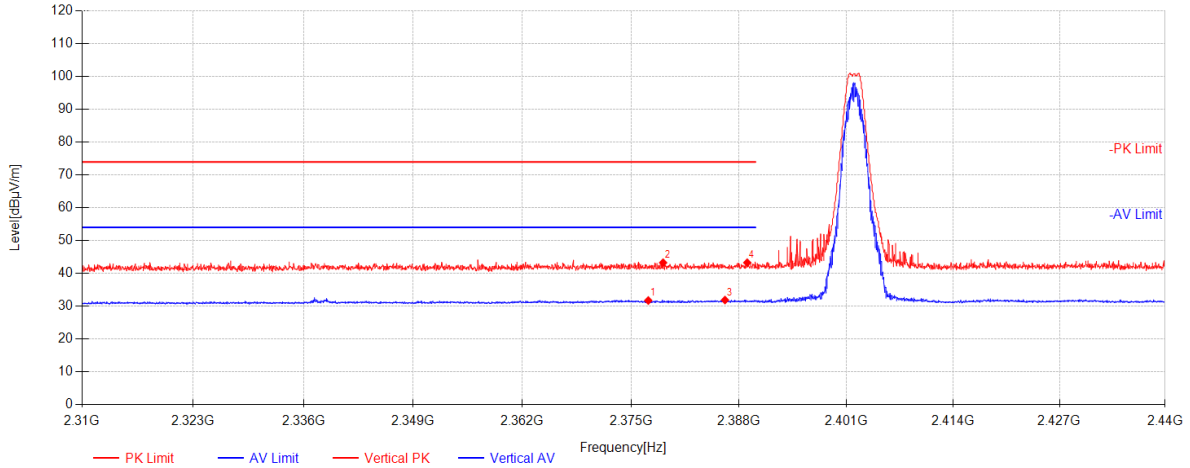

| Data List |                 |                |           |             |                |                |             |             |           |          |
|-----------|-----------------|----------------|-----------|-------------|----------------|----------------|-------------|-------------|-----------|----------|
| NO.       | Frequency [MHz] | Reading [dBµV] | AF [dB/m] | Factor [dB] | Level [dBµV/m] | Limit [dBµV/m] | Margin [dB] | Height [cm] | Angle [°] | Polarity |
| 1         | 2377.08         | 27.85          | 27.43     | -23.57      | 31.71          | 54.00          | 22.29       | 152         | 34        | Vertical |
| 2         | 2378.8567       | 39.38          | 27.43     | -23.57      | 43.24          | 74.00          | 30.76       | 152         | 34        | Vertical |
| 3         | 2386.31         | 28.00          | 27.43     | -23.57      | 31.86          | 54.00          | 22.14       | 152         | 34        | Vertical |
| 4         | 2388.9967       | 39.40          | 27.43     | -23.57      | 43.26          | 74.00          | 30.74       | 152         | 34        | Vertical |



Unless otherwise agreed in writing, this document is issued by the Company subject to its General Conditions of Service printed overleaf, available on request or accessible at <http://www.sgs.com/en/Terms-and-Conditions.aspx> and, for electronic format documents, subject to Terms and Conditions for Electronic Documents at <http://www.sgs.com/en/Terms-and-Conditions/Terms-e-Documents.aspx>. Attention is drawn to the limitation of liability, indemnification and jurisdiction issues defined therein. Any holder of this document is advised that information contained hereon reflects the Company's findings at the time of its intervention only and within the limits of Client's instructions, if any. The Company's sole responsibility is to its Client and this document does not exonerate parties to a transaction from exercising all their rights and obligations under the transaction documents. This document cannot be reproduced except in full, without prior written approval of the Company. Any unauthorized alteration, forgery or falsification of the content or appearance of this document is unlawful and offenders may be prosecuted to the fullest extent of the law. Unless otherwise stated the results shown in this test report refer only to the sample(s) tested and such sample(s) are retained for 30 days only.

Attention: To check the authenticity of testing/inspection report & certificate, please contact us at telephone: (86-755) 8307 1443, or email: [CN.Doccheck@sgs.com](mailto:CN.Doccheck@sgs.com)

South of No. 6 Plant, No. 1, Runsheng Road, Suzhou Industrial Park, Suzhou Area, China (Jiangsu) Pilot Free Trade Zone 215000 t (86-512) 62992980 www.sgs.com.cn  
 中国·苏州·中国(江苏)自由贸易试验区苏州片区苏州工业园区润胜路1号的6号厂房南楼 邮编: 215000 t (86-512) 62992980 sgs.china@sgs.com

BLE 2M\_Channel 39

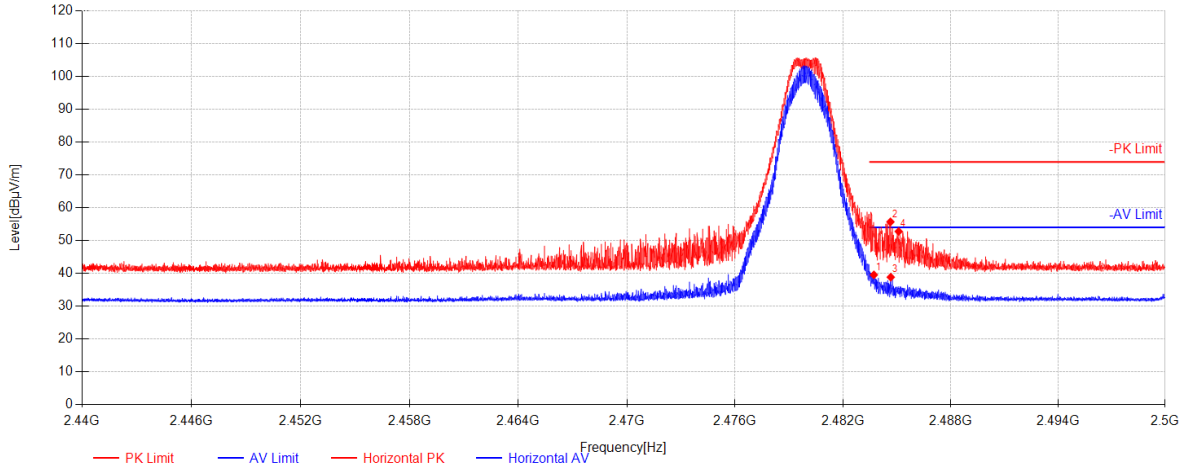

| Data List |                 |                |           |             |                |                |             |             |           |            |
|-----------|-----------------|----------------|-----------|-------------|----------------|----------------|-------------|-------------|-----------|------------|
| NO.       | Frequency [MHz] | Reading [dBµV] | AF [dB/m] | Factor [dB] | Level [dBµV/m] | Limit [dBµV/m] | Margin [dB] | Height [cm] | Angle [°] | Polarity   |
| 1         | 2483.725        | 35.37          | 27.72     | -23.54      | 39.54          | 54.00          | 14.46       | 211         | 189       | Horizontal |
| 2         | 2484.6475       | 51.53          | 27.72     | -23.54      | 55.70          | 74.00          | 18.30       | 211         | 189       | Horizontal |
| 3         | 2484.6625       | 34.66          | 27.72     | -23.54      | 38.83          | 54.00          | 15.17       | 211         | 189       | Horizontal |
| 4         | 2485.105        | 48.59          | 27.72     | -23.54      | 52.77          | 74.00          | 21.23       | 211         | 189       | Horizontal |



Unless otherwise agreed in writing, this document is issued by the Company subject to its General Conditions of Service printed overleaf, available on request or accessible at <http://www.sgs.com/en/Terms-and-Conditions.aspx> and, for electronic format documents, subject to Terms and Conditions for Electronic Documents at <http://www.sgs.com/en/Terms-and-Conditions/Terms-e-Documents.aspx>. Attention is drawn to the limitation of liability, indemnification and jurisdiction issues defined therein. Any holder of this document is advised that information contained hereon reflects the Company's findings at the time of its intervention only and within the limits of Client's instructions, if any. The Company's sole responsibility is to its Client and this document does not exonerate parties to a transaction from exercising all their rights and obligations under the transaction documents. This document cannot be reproduced except in full, without prior written approval of the Company. Any unauthorized alteration, forgery or falsification of the content or appearance of this document is unlawful and offenders may be prosecuted to the fullest extent of the law. Unless otherwise stated the results shown in this test report refer only to the sample(s) tested and such sample(s) are retained for 30 days only.

Attention: To check the authenticity of testing/inspection report & certificate, please contact us at telephone: (86-755) 8307 1443, or email: [CN.Doccheck@sgs.com](mailto:CN.Doccheck@sgs.com)

South of No. 6 Plant, No. 1, Runsheng Road, Suzhou Industrial Park, Suzhou Area, China (Jiangsu) Pilot Free Trade Zone 215000 t (86-512) 62992980 www.sgsgroup.com.cn  
 中国·苏州·中国(江苏)自由贸易试验区苏州片区苏州工业园区润胜路1号的6号厂房南楼 邮编: 215000 t (86-512) 62992980 sgs.china@sgs.com

BLE 2M\_Channel 39

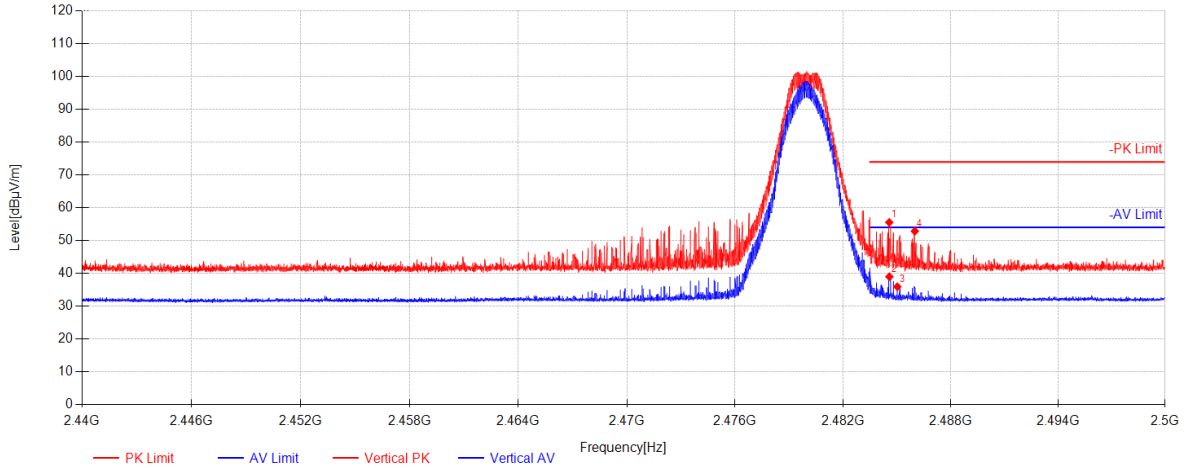

| Data List |                 |                |           |             |                |                |             |             |           |          |
|-----------|-----------------|----------------|-----------|-------------|----------------|----------------|-------------|-------------|-----------|----------|
| NO.       | Frequency [MHz] | Reading [dBµV] | AF [dB/m] | Factor [dB] | Level [dBµV/m] | Limit [dBµV/m] | Margin [dB] | Height [cm] | Angle [°] | Polarity |
| 1         | 2484.58         | 51.38          | 27.72     | -23.54      | 55.55          | 74.00          | 18.45       | 236         | 43        | Vertical |
| 2         | 2484.5875       | 34.81          | 27.72     | -23.54      | 38.98          | 54.00          | 15.02       | 236         | 43        | Vertical |
| 3         | 2485.03         | 31.75          | 27.72     | -23.54      | 35.93          | 54.00          | 18.07       | 236         | 43        | Vertical |
| 4         | 2486.005        | 48.68          | 27.72     | -23.54      | 52.86          | 74.00          | 21.14       | 236         | 43        | Vertical |

Remark:

1) The field strength is calculated by adding the Antenna Factor, Cable Factor & Preamplifier gain. The basic equation with a sample calculation is as follows:

$$\text{Level} = \text{Reading}(\text{dB}\mu\text{V}) + \text{AF}(\text{dB}/\text{m}) + \text{Factor}(\text{dB});$$

$$\text{AF} = \text{Antenna Factor}(\text{dB}/\text{m})$$

$$\text{Factor} = \text{Cable Factor}(\text{dB}) - \text{Preamplifier gain}(\text{dB})$$

$$\text{Margin} = \text{Limit}(\text{dB}\mu\text{V}/\text{m}) - \text{Level}(\text{dB}\mu\text{V}/\text{m})$$

---End of Report---



Unless otherwise agreed in writing, this document is issued by the Company subject to its General Conditions of Service printed overleaf, available on request or accessible at <http://www.sgs.com/en/Terms-and-Conditions.aspx> and, for electronic format documents, subject to Terms and Conditions for Electronic Documents at <http://www.sgs.com/en/Terms-and-Conditions/Terms-e-Documents.aspx>. Attention is drawn to the limitation of liability, indemnification and jurisdiction issues defined therein. Any holder of this document is advised that information contained hereon reflects the Company's findings at the time of its intervention only and within the limits of Client's instructions, if any. The Company's sole responsibility is to its Client and this document does not exonerate parties to a transaction from exercising all their rights and obligations under the transaction documents. This document cannot be reproduced except in full, without prior written approval of the Company. Any unauthorized alteration, forgery or falsification of the content or appearance of this document is unlawful and offenders may be prosecuted to the fullest extent of the law. Unless otherwise stated the results shown in this test report refer only to the sample(s) tested and such sample(s) are retained for 30 days.  
**Attention: To check the authenticity of testing/inspection report & certificate, please contact us at telephone: (86-755) 8307 1443, or email: CN.Doccheck@sgs.com**

South of No. 6 Plant, No. 1, Runsheng Road, Suzhou Industrial Park, Suzhou Area, China (Jiangsu) Pilot Free Trade Zone 215000  
 中国·苏州·中国(江苏)自由贸易试验区苏州片区苏州工业园区润胜路1号的6号厂房南楼 邮编: 215000

t (86-512) 62992980 www.sgs.com.cn  
 t (86-512) 62992980 sgs.china@sgs.com