



NFC TEST REPORT

No.I22Z60821-IOT07

for

GOOSEA GROUP (HK) COMPANY LIMITED

Smart Phone

Model Name: SN304AE

FCC ID: 2A28USN304AE

with

Hardware Version: V1.0

Software Version: SN304AEC10102

Issued Date: 2022-07-04

Note:

The test results in this test report relate only to the devices specified in this report. This report shall not be reproduced except in full without the written approval of CTTL.

The report must not be used by the client to claim product certification, approval, or endorsement by NVLAP, NIST, or any agency of the U.S.Government.

Test Laboratory:

CTTL-Telecommunication Technology Labs, CAICT

No. 52, Huayuan North Road, Haidian District, Beijing, P. R. China 100191.

Tel:+86(0)10-62304633-2512, Fax:+86(0)10-62304633-2504

Email: ctl_terminals@caict.ac.cn, website: www.caict.ac.cn



REPORT HISTORY

Report Number	Revision	Description	Issue Date
I22Z60821-IOT07	Rev.0	1 st edition	2022-06-17
I22Z60821-IOT07	Rev.1	Identified the field strength of fundamental frequency in page 15.	2022-07-04

Note: the latest revision of the test report supersedes all previous version.



CONTENTS

1. TEST LABORATORY	4
1.1. INTRODUCTION & ACCREDITATION.....	4
1.2. TESTING LOCATION	4
1.3. TESTING ENVIRONMENT	5
1.4. PROJECT DATA	5
1.5. SIGNATURE.....	5
2. CLIENT INFORMATION.....	6
2.1. APPLICANT INFORMATION.....	6
2.2. MANUFACTURER INFORMATION.....	6
3. EQUIPMENT UNDER TEST (EUT) AND ANCILLARY EQUIPMENT (AE)	7
3.1. ABOUT EUT	7
3.2. INTERNAL IDENTIFICATION OF EUT	7
3.3. INTERNAL IDENTIFICATION OF AE	7
3.4. EUT SET-UPS.....	8
4. REFERENCE DOCUMENTS	9
4.1. DOCUMENTS SUPPLIED BY APPLICANT	9
4.2. REFERENCE DOCUMENTS FOR TESTING.....	9
5. TEST RESULTS	10
5.1. SUMMARY OF TEST RESULTS	10
5.2. STATEMENTS.....	10
6. TEST FACILITIES UTILIZED	11
7. MEASUREMENT UNCERTAINTY	12
ANNEX A: EUT PARAMETERS.....	13
ANNEX B: DETAILED TEST RESULTS.....	14
ANNEX C: PERSONS INVOLVED IN THIS TESTING	26
ANNEX D: ACCREDITATION CERTIFICATE	27



1. Test Laboratory

1.1. Introduction & Accreditation

Telecommunication Technology Labs, CAICT is an ISO/IEC 17025:2017 accredited test laboratory under NATIONAL VOLUNTARY LABORATORY ACCREDITATION PROGRAM (NVLAP) with lab code 600118-0, and is also an FCC accredited test laboratory (CN5017), and ISED accredited test laboratory (ISED#: 24849). The detail accreditation scope can be found on NVLAP website.

1.2. Testing Location

Location 1: CTTL(huayuan North Road)

Address: No. 52, Huayuan North Road, Haidian District, Beijing,
P. R. China 100191

1.3. Testing Environment

Normal Temperature: 15-35°C
Extreme Temperature: -20/+55°C
Normal Relative Humidity: 20-75%
Normal Air Pressure 86Kpa-106Kpa

1.4. Project data

Testing Start Date: 2022-05-20
Testing End Date: 2022-06-17

1.5. Signature



Zhou Bin

(Prepared this test report)



Zhang Qiang

(Reviewed this test report)



Zhu Liang

(Approved this test report)



2. Client Information

2.1. Applicant Information

Company Name: COOSEA GROUP (HK) COMPANY LIMITED
Address: UNIT 5-6 16/F MULTIFIELD PLAZA 3-7A PRAT AVENUE TSIM
SHA TSUI KL
Contact: zhaojiandong
Telephone: 13759849661
Email: zhaojiandong@cooseagroup.com

2.2. Manufacturer Information

Company Name: COOSEA GROUP (HK) COMPANY LIMITED
Address: UNIT 5-6 16/F MULTIFIELD PLAZA 3-7A PRAT AVENUE TSIM
SHA TSUI KL
Contact: zhaojiandong
Telephone: 13759849661
Email: zhaojiandong@cooseagroup.com

3. Equipment Under Test (EUT) and Ancillary Equipment (AE)

3.1. About EUT

Description	Smart Phone
Model Name	SN304AE
FCC ID	2A28USN304AE
UMTS Frequency bands	FDD II/IV/V
E-UTRA Frequency bands	FDD 2/4/5/12/14/29/30/66 TDD 48
5G NR Frequency bands	NSA n2/n5/n30/n66/n77
Operating temperature	-10/+55°C
Extreme low voltage	3.5 V
Normal voltage	3.85 V
Extreme high voltage	4.4 V

3.2. Internal Identification of EUT

EUT ID*	SN or IMEI	HW Version	SW Version
UT45a	354266480006484	V1.0	SN304AEC10102
UT04a	354266480006617	V1.0	SN304AEC10102

*EUT ID: is used to identify the test sample in the lab internally.

3.3. Internal Identification of AE

AE ID*	Description	SN	Remarks
AE1	Battery	/	/
AE2	USB Cable	/	/
AE3	Charger	/	/

AE1

Model	JU001
Manufacturer	Jiade Energy Technology (Zhuhai) Co.,Ltd.
Capacity	4000mAh
Nominal Voltage	3.85V

AE2

Model	TPA-46B050100UU
Manufacturer	SHENZHEN TIANYIN ELECTRONICS CO.,LTD
Length of cable	/

AE3

Model	USB TYPE A to C 2.0 Cable
Manufacturer	Huizhou Washin Electronics Co.,Ltd
Length of cable	/

*AE ID: is used to identify the ancillary equipment in the lab internally.



3.4. EUT Set-ups

EUT set-up No.	Combination of EUT and AE	Remarks
Set.NFC01	UT04a + AE1 + AE2 + AE3 + NFC Card	Charge
Set.NFC02	UT04a + AE1+ NFC card	NFC
Set.NFC03	UT45a	---

The Transmit State of NFC: the NFC function is on. The EUT will transmit the NFC data and command continuously during the test.

The Transmit state without modulation: The EUT will transmit the CW signal at the operating frequency.

4. Reference Documents

4.1. Documents supplied by applicant

EUT parameters, referring to Annex A for detailed information, are supplied by the client or manufacturer, which are the bases of testing.

4.2. Reference Documents for testing

The following documents listed in this section are referred for testing.

Reference	Title	Version
CFR 47 Part 2	Part 2 — Frequency Allocations and Radio Treaty Matters; General Rules and Regulations.	2019
CFR 47 Part 15	Part 15 — Radio Frequency Devices. Subpart C — Intentional Radiators. § 15.35 Measurement detector functions and bandwidths. § 15.207 Conducted limits. § 15.209 Radiated emission limits, general requirements. § 15.215 Additional provisions to the general radiated emission limitations. § 15.225 Operation within the band 13.110–14.010 MHz.	2019
ANSI C63.10	American National Standard of Procedures for Compliance Testing of Unlicensed Wireless Devices	2013

5. Test Results

5.1. Summary of Test Results

No	Test Cases	Clause in Regulation	Section in This Report	Verdict
1	Electric Field Strength of Fundamental Emissions	CFR 47 § 15.225(a)	B.1	P(Set. NFC02)
2	Electric Field Strength of Outside the Allocated Bands	CFR 47 § 15.225(b) CFR 47 § 15.225(c)		P(Set. NFC02)
3	Electric Field Radiated Emissions	CFR 47 § 15.209	B.2	P(Set. NFC01)
		CFR 47 § 15.225(d)	B.3	P(Set. NFC01)
4	Frequency Tolerance	CFR 47 § 15.225(e)	B.4	P(Set. NFC03)
5	20dB Bandwidth	CFR 47 § 15.215(c)	B.5	P(Set. NFC03)
6	Conducted Emissions	CFR 47 § 15.207	B.6	P(Set. NFC01)
The measurement is carried out according to ANSI C63.10. See ANNEX B for details.				

Test Conditions:

For this report, all the test cases listed above were tested under normal Temperature, Voltage, humidity and Air Pressure except the Frequency Tolerance test case. The specific conditions of Frequency Tolerance test case are listed in section B.4.3

See **Table 3** for terms for result verdict:

Table 1 Terms for result verdict

P	Pass, The EUT complies with the essential requirements in the standard.
NP	Not Perform, The test was not performed by CTTL
NA	Not Applicable, The test was not applicable
F	Fail, The EUT does not comply with the essential requirements in the standard

5.2. Statements

The test cases listed in Section 5.1 of this report for the EUT specified in Section 3 were performed by CTTL according to the reference documents in Section 4.

The EUT meets all applicable requirements of the regulations and standards in Section 4.2.

6. Test Facilities Utilized

NO.	NAME	TYPE	SERIES NUMBER	PRODUCER	CAL. DUE DATE	CAL. INTERVAL
1.	Spectrum Analyzer	RSA3408A	B010277	Tektronix	2022-10-28	1 Year
2.	Climatic chamber	SH242	93008658	ESPEC	2023-02-21	2 Year
3.	Test Receiver	ESW44	103023	R&S	2022-10-28	1 Year
4.	H-field Antenna	HFH2-Z2	829324/007	R&S	2022-12-23	1 Year
5.	EMI Antenna	VULB 9163	302	SCHWARZBEC K	2022-12-28	1 Year
6.	Test Receiver	ESCI	100344	R&S	2023-03-21	1 Year
7.	LISN	ENV216	101200	R&S	2022-06-29	1 Year

7. Measurement Uncertainty

Item	Uncertainty
Frequency Tolerance	$U = 77 \text{ Hz}, k=2$
20dB Bandwidth	$U = 77 \text{ Hz}, k=2$
Radiated Emissions(9kHz-30MHz)	$U = 4.92 \text{ dB}, k=2$
Radiated Emissions (30MHz-1GHz)	$U = 5.15 \text{ dB}, k=2$
Radiated Emissions (>1GHz)	$U = 5.54 \text{ dB}, k=2$
Conducted emission	$U = 3.08 \text{ dB}, k=2$



ANNEX A: EUT parameters

/

ANNEX B: Detailed Test Results

B.1. Electric Field Strength of Fundamental and Outside the Allocated bands

B.1.1. Reference

See Clause 4, Clause 5 of ANSI C63.10-2013 generally.

B.1.2. Measurement Methods

The transmitter carrier output levels (E-Field) from the EUT are measured in a semi-anechoic chamber. The EUT is placed on a non-conductive stand of 80cm high, and at a measurement distance of 3m from the receiving antenna. The center of the receiving loop antenna is 1.0 meter above the ground. The E-field is measured with a shielded loop antenna connected to a measurement receiver. Detected E-field was maximized by rotating the EUT through 360° and adjusting the receiving antenna polarizations. The maximization processes were repeated with the EUT positioned respectively in its three orthogonal axes. The measurements were performed with the peak detector and if required, the quasi-peak detector.

The measurement bandwidth is:

Table B-1: Measurement bandwidth

Frequency of Emission (MHz)	RBW/VBW
12.56-14.56	10/30 kHz

The E-field measured at 3m is calculated as:

$$\text{E-field (dB}\mu\text{V/m)} = \text{Rx (dB}\mu\text{V)} + \text{Cable Loss (dB)} + \text{AF@3m (dB/m)}$$

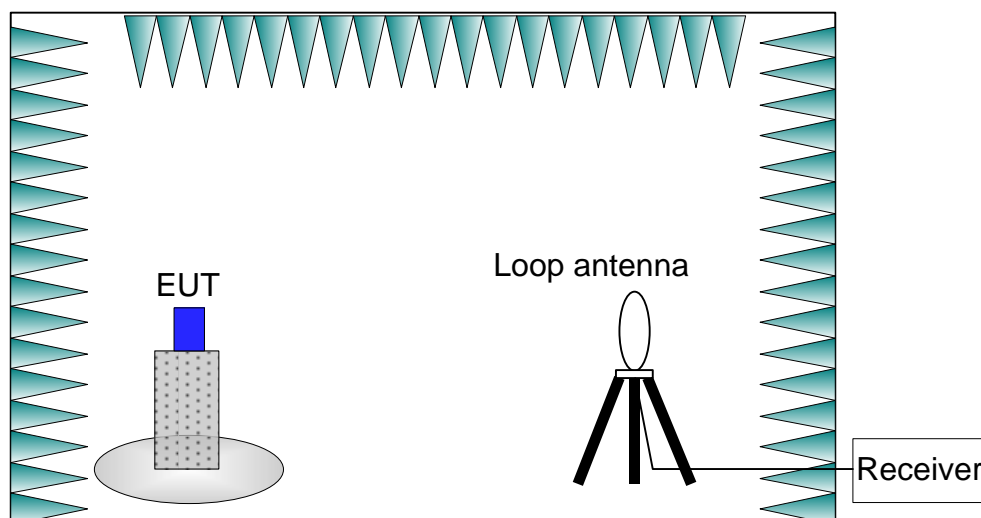

Figure B-1: Measurement Setup

B.1.3. EUT Operating Mode and Test Conditions

The measurement of EUT is carried out under the transmit state of NFC(See 3.4).

The EUT is powered by a travel adapter.

During the measurements, the ambient temperature of the electromagnetic anechoic chamber is in the range of 15 ~ 25 °C.

B.1.4. Limits

Table B-2: Limits

Frequency Range (MHz)	E-field Strength Limit @ 30 m (μV/m)	E-field Strength Limit @ 3 m (dBμV/m)
13.560 ± 0.007	+15,848	124
13.410 to 13.553 13.567 to 13.710	+334	90
13.110 to 13.410 13.710 to 14.010	+106	81

Note: Where the limits have been defined at one distance, and a signal level measured at another, the limits have been extrapolated using the following formula:

$$\text{Extrapolation(dB)} = 40\log_{10}(\text{Measurement Distance}/\text{Specification Distance})$$

B.1.5. Measurement Results

Measurement results of normal conditions see Figure B-2 for different set-ups of EUT. The results displayed take into account applicable antenna factors and cable losses.

Conclusions: Set.NFC02, **PASS**.

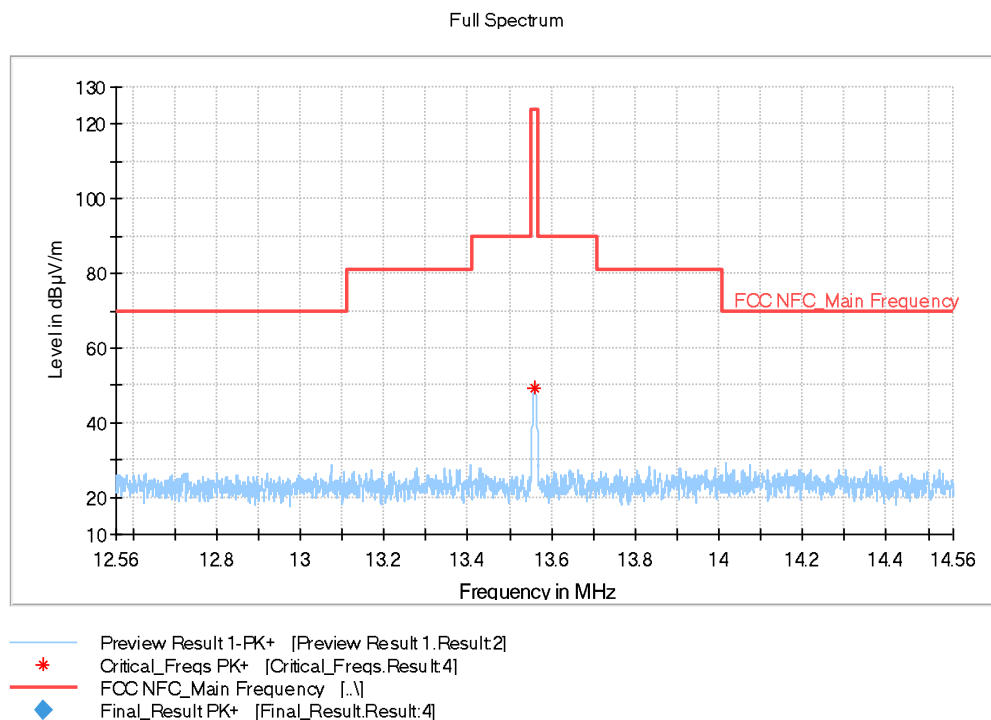

Figure B-2: Measurement results for Electric Field Strength of Fundamental and Outside the Allocated bands

Frequency (MHz)	MaxPeak (dBμV/m)	Limit (dBμV/m)	Margin (dB)	Meas. Time (ms)	Bandwidth (kHz)	Pol	Azimuth (deg)	Corr. (dB/m)
13.560000	49.10	124.00	74.90	---	---	V	0.0	17.9

B.2. Electric Field Radiated Emissions (< 30MHz)

B.2.1. Reference

See Clause 6.4 of ANSI C63.10-2013 specifically.

See Clause 4 and Clause 5 of ANSI C63.10-2013 generally.

B.2.2. Measurement Methods

The transmitter carrier output levels (E-Field) from the EUT are measured in a semi-anechoic chamber. The EUT is placed on a non-conductive stand of 80cm high, and at a measurement distance of 3m from the receiving antenna. The center of the receiving loop antenna is 1.0 meter above the ground. The E-field is measured with a shielded loop antenna connected to a measurement receiver. Detected E-field was maximized by rotating the EUT through 360° and adjusting the receiving antenna polarizations. The maximization processes were repeated with the EUT positioned respectively in its three orthogonal axes. The measurements were performed with the peak detector and if required, the quasi-peak detector.

The measurement bandwidth is:

Frequency of Emission (MHz)	RBW/VBW
0.009-0.15	100/300 Hz
0.15-30	10/30 kHz

The E-field measured at 3m is calculated as:

$$\text{E-field (dB}\mu\text{V/m)} = \text{Rx (dB}\mu\text{V)} + \text{Cable Loss (dB)} + \text{AF@3m (dB/m)}$$

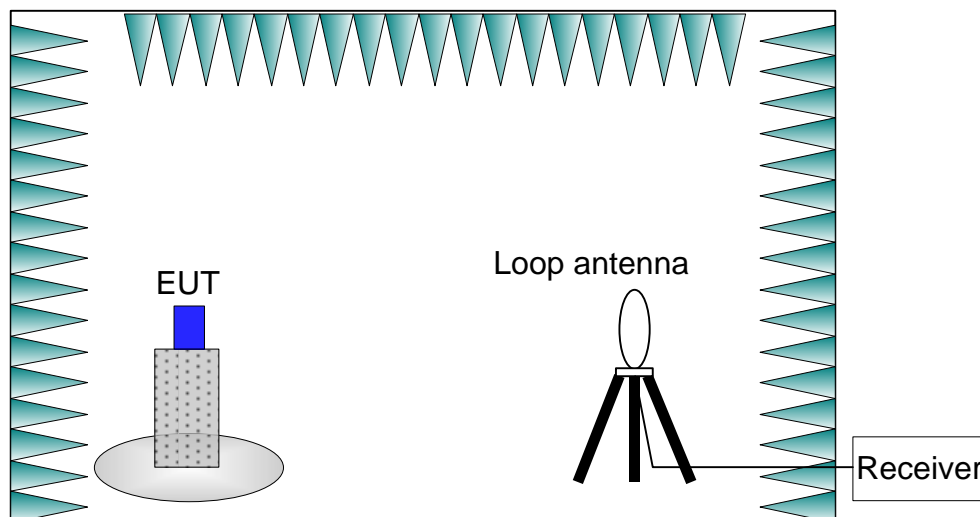

Figure B-3: Measurement Setup

B.2.3. EUT Operating Mode and Test Conditions

The measurement of EUT is carried out under the transmit state of NFC(See 3.4).

The EUT is powered by a travel adapter.

During the measurements, the ambient temperature of the electromagnetic anechoic chamber is in the range of 15 ~ 25 °C.

B.2.4. Limits

Frequency Range (MHz)	E-field Strength Limit @ 30m (mV/m)	E-field Strength Limit @ 3m (dBµV/m)
0.009-0.490	2400/F(kHz)	129-94
0.490-1.705	24000/F(kHz)	74-63
1.705-30	30	70

Note: Where the limits have been defined at one distance, and a signal level measured at another, the limits have been extrapolated using the following formula:
 Extrapolation(dB) = 40log₁₀(Measurement Distance/Specification Distance)

B.2.5. Measurement Results

Measurement results of normal conditions see Figure B-4 for different set-ups of EUT. The results displayed take into account applicable antenna factors and cable losses.

Conclusions: Set.NFC01, **PASS**.

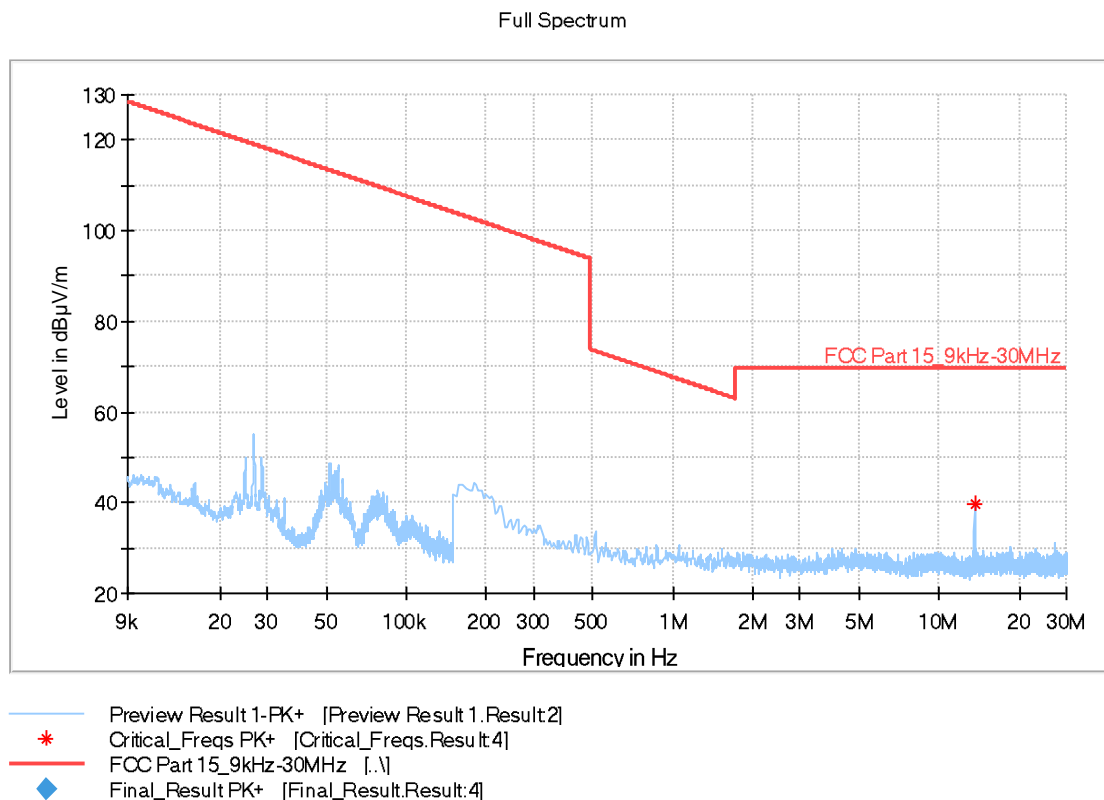

Figure B-4: Measurement results for Electric Field Radiated Emissions (< 30MHz)

B.3. Electric Field Radiated Emissions ($\geq 30\text{MHz}$)

B.3.1. Reference

See Clause 6.5 of ANSI C63.10-2013 specifically.

See Clause 4 and Clause 5 of ANSI C63.10-2013 generally.

B.3.2. Measurement Methods

The electric field radiated emissions from the EUT are measured in a semi-anechoic chamber. The EUT is placed on a non-conductive stand of 80cm high, and at a measurement distance of 10m from the receiving antenna. The receiving antennas connected to a measurement receiver. In order to search for maximum field strength emitted from the EUT, the receiving antenna can be moved between the height of 1.0 m to 4.0 m. Detected E-field was maximized at each frequency by rotating the EUT through 360° and adjusting the receiving antenna positions for both vertical and horizontal antenna polarizations. The maximization processes were repeated with the EUT positioned respectively in its three orthogonal axes. The measurements were performed with the peak detector and if required, the quasi-peak detector.

The measurement bandwidth is:

Frequency of Emission (MHz)	RBW/VBW
30-1000	120kHz

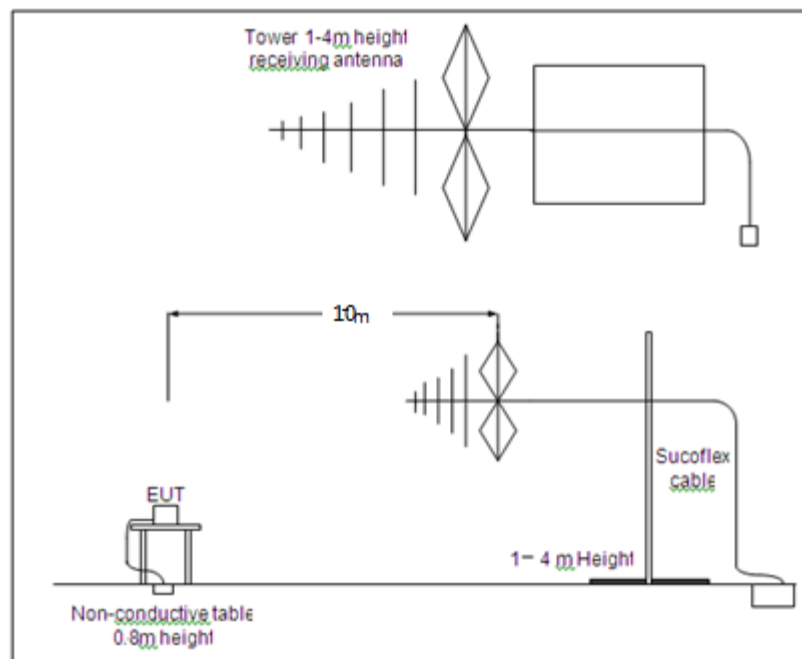

Figure B-5: Measurement Setup

B.3.3. EUT Operating Mode and Test Conditions

The measurement of EUT is carried out under the transmit state of NFC(See 3.4).

The EUT had been connected to a travel adapter.

During the measurements, the ambient temperature of the electromagnetic anechoic chamber is

in the range of 15 ~ 25 °C.

B.3.4. Limits

Frequency Range (MHz)	E-field Strength Limit @ 3m (mV/m)	E-field Strength Limit @ 3m (dB μ V/m)	E-field Strength Limit @ 10m (dB μ V/m)
30-88	100	40	30
88-216	150	43.5	33.5
216-960	200	46	36
960-1000	500	54	44

B.3.5. Measurement Results

Measurement results of normal conditions see Figure B-6 for different set-ups of EUT. The results displayed take into account applicable antenna factors and cable losses.

Conclusions: Set.NFC01, **PASS**.

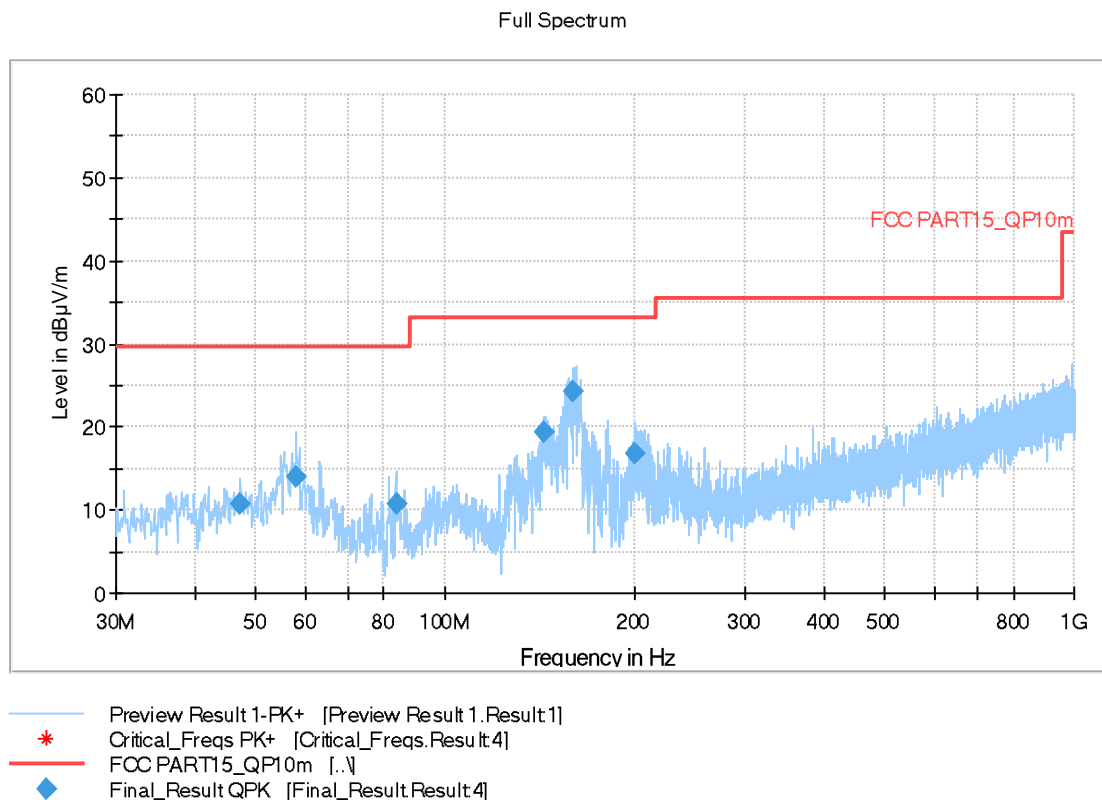

Figure B-6: Measurement results for Electric Field Radiated Emissions (≥ 30 MHz)

Frequency	QuasiPeak	Limit	Margin	Meas. Time	Bandwidth	Height	Pol	Azimuth
47.266000	10.73	29.54	18.81	2000.0	120.000	325.0	V	2.0
58.033000	14.04	29.54	15.50	2000.0	120.000	325.0	V	277.0
83.641000	10.83	29.54	18.71	2000.0	120.000	275.0	V	315.0
143.975000	19.42	33.06	13.64	2000.0	120.000	98.0	V	96.0
159.592000	24.24	33.06	8.82	2000.0	120.000	175.0	V	0.0
200.914000	16.72	33.06	16.34	2000.0	120.000	125.0	V	47.0

B.4. Frequency Tolerance

B.4.1. Reference

See Clause 6.8 of ANSI C63.10-2013 specifically.

See Clause 4 and Clause 5 of ANSI C63.10-2013 generally.

B.4.2. Measurement Methods

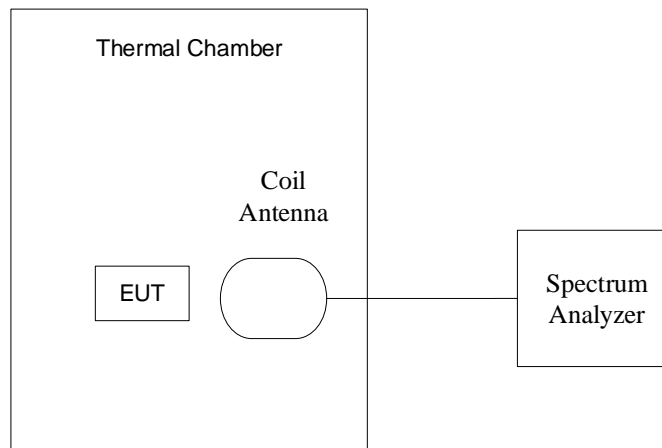

Figure B-7: Measurement Setup

The transmitter output signal was picked up by coil antenna connected to the spectrum analyzer. The center frequency was measured with 30Hz RBW and 1kHz span.

During the test, the EUT was placed in a thermal chamber until thermal balance and lasting appropriate time.

B.4.3. EUT Operating Mode and Test Conditions

The measurement of EUT was carried out under the transmit state of without modulation(See 3.4). EUT had not been connected to a travel adapter. The frequency stability was measured with the different voltage and temperature combinations:

- a) The nominal voltage 3.85V(See 3.1)was used and the temperature was varied from -20°C to +50°C in 10°C increments using an environmental chamber.
- b) The 20°C was used and the voltages were 3.6V, 3.85V and 4.4V (The extreme low voltage ,the normal voltage and the extreme high voltage defined in section 3.1).

The details were as following:

Table B-3: Combinations of Voltage and Temperature

Test items	Voltage	Temperature
Frequency stability with respect to ambient temperature	3.85V	-20°C
		-10°C
		0°C
		10°C
		20°C
		30°C
		40°C

		50°C
Frequency stability when varying supply voltage	3.6 V	20°C
	3.85V	
	4.4V	

B.4.4. Test Layouts

See B.4.2.

B.4.5. Limits

The frequency tolerance of the carrier signal shall be maintained within +/- 0.01% of the operating frequency.

B.4.6. Measurement Results

Measurement results see Table B-4 for different test conditions.

Conclusions: Set.NFC03, **PASS**.

Table B-4: Measurement results for Frequency Tolerance

Temperature	Voltage	Frequency (MHz)			
		Startup	2 Min Later	5 Min Later	10 Min Later
-20°C	3.85V	13.560028125	13.560028125	13.560028125	13.560025000
-10°C	3.85V	13.560053125	13.560053125	13.560053125	13.560053125
0°C	3.85V	13.560053125	13.560053125	13.560056250	13.560056250
10°C	3.85V	13.560034375	13.560037500	13.560040625	13.560043750
20°C	3.85V	13.560009375	13.560015625	13.560018750	13.560018750
30°C	3.85V	13.560009375	13.560003125	13.559996875	13.559993750
40°C	3.85V	13.559971875	13.559968750	13.559968750	13.559965625
50°C	3.85V	13.559959375	13.559953125	13.559946875	13.559946875
20°C	3.6V	13.559993750	13.560006250	13.560015625	13.560018750
20°C	4.4V	13.560006250	13.560012500	13.560018750	13.560018750

Temperature	Voltage	Frequency Error (%)			
		Startup	2 Min Later	5 Min Later	10 Min Later
-20°C	3.85V	0.000	0.000	0.000	0.000
-10°C	3.85V	0.000	0.000	0.000	0.000
0°C	3.85V	0.000	0.000	0.000	0.000
10°C	3.85V	0.000	0.000	0.000	0.000
20°C	3.85V	0.000	0.000	0.000	0.000
30°C	3.85V	0.000	0.000	0.000	0.000
40°C	3.85V	0.000	0.000	0.000	0.000
50°C	3.85V	0.000	0.000	0.000	0.000
20°C	3.5V	0.000	0.000	0.000	0.000
20°C	4.4V	0.000	0.000	0.000	0.000

B.4.7. Measurement Uncertainty

Measurement uncertainty: $U = 77 \text{ Hz}$, $k=2$

B.5. 20dB Bandwidth

B.5.1. Reference

See Clause 6.9 of ANSI C63.10-2013 specifically.

See Clause 4 and Clause 5 of ANSI C63.10-2013 generally.

B.5.2. Measurement Methods

The transmitter output signal was picked up by coil antenna connected to the spectrum analyzer. The bandwidth of the center frequency was measured with 140Hz RBW, 420Hz VBW and 14kHz span.

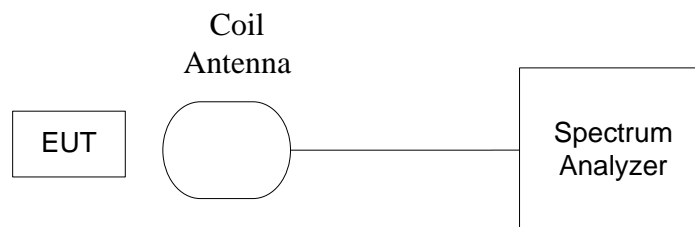

Figure B-8: Measurement Setup

B.5.3. EUT Operating Mode and Test Conditions

The measurement of EUT was carried out under the transmit state of NFC (See 3.4).

EUT had not been connected to a travel adapter.

During the measurements, the ambient temperature was in the range of 15 ~ 25 °C.

B.5.4. Test Layouts

See B.5.2.

B.5.5. Limits

The 20dB bandwidth shall be less than 80% of the permitted frequency band. For 13.56 MHz NFC, the permitted frequency band is 14kHz, so the limit is 11.2 kHz.

B.5.6. Measurement Results

Measurement results see Figure B-9.

Conclusions: Set.NFC03, **PASS**.

B.6. Conducted emission

B.6.1. Reference

See Clause 6.2 of ANSI C63.10-2013 specifically.

See Clause 4 and Clause 5 of ANSI C63.10-2013 generally.

B.6.2. Measurement Methods

The conducted emissions from the AC port of the EUT are measured in a shielding room. The EUT is connected to a Line Impedance Stabilization Network (LISN). An overview sweep with peak detection was performed. The measurements were performed with a quasi-peak detector and if required, an average detector.

The conducted emission measurements were made with the following detector of the test receiver: Quasi-Peak / Average Detector.

The measurement bandwidth is:

Table B-5: Measurement Bandwidth

Frequency of Emission (MHz)	RBW/VBW
0.15-30	9kHz

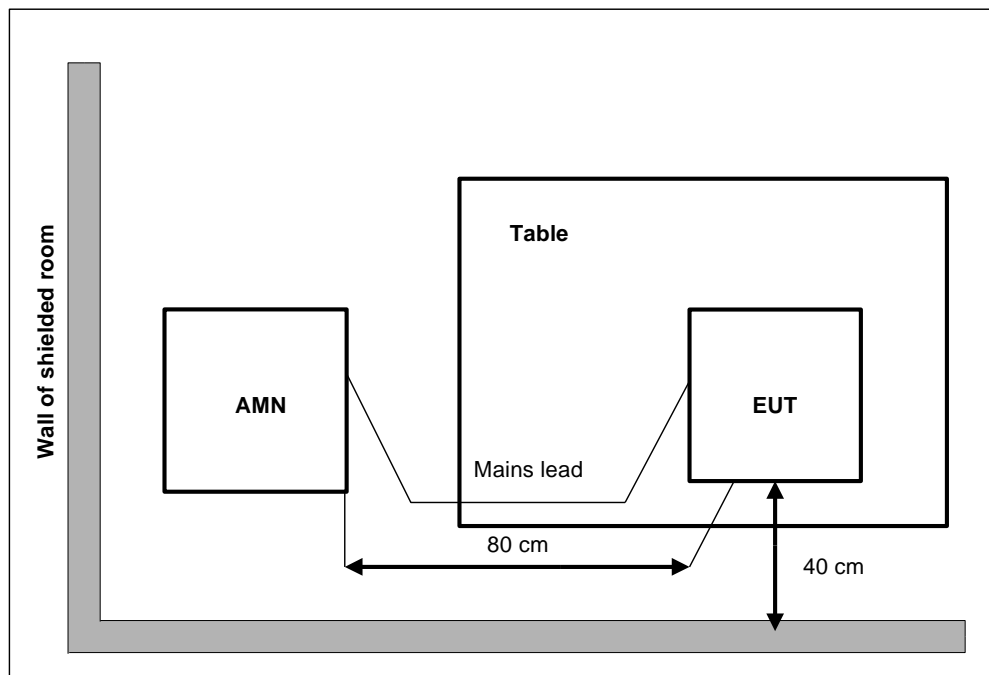

Figure B-10: Measurement Setup

B.6.3. EUT Operating Mode and Test Conditions

The measurement of EUT is carried out under the transmit state of NFC(See 3.4).

The EUT is powered by a travel adapter.

During the measurements, the ambient temperature is in the range of 15 ~ 25 °C.

B.6.4. Limits

Frequency range (MHz)	Quasi-peak Limit (dB μ V)	Average Limit (dB μ V)
0.15 to 0.5	66 to 56	56 to 46
0.5 to 5	56	46
5 to 30	60	50

B.6.5. Measurement Results

Measurement results see Figure B-11.

Conclusions: Set.NFC01, PASS.

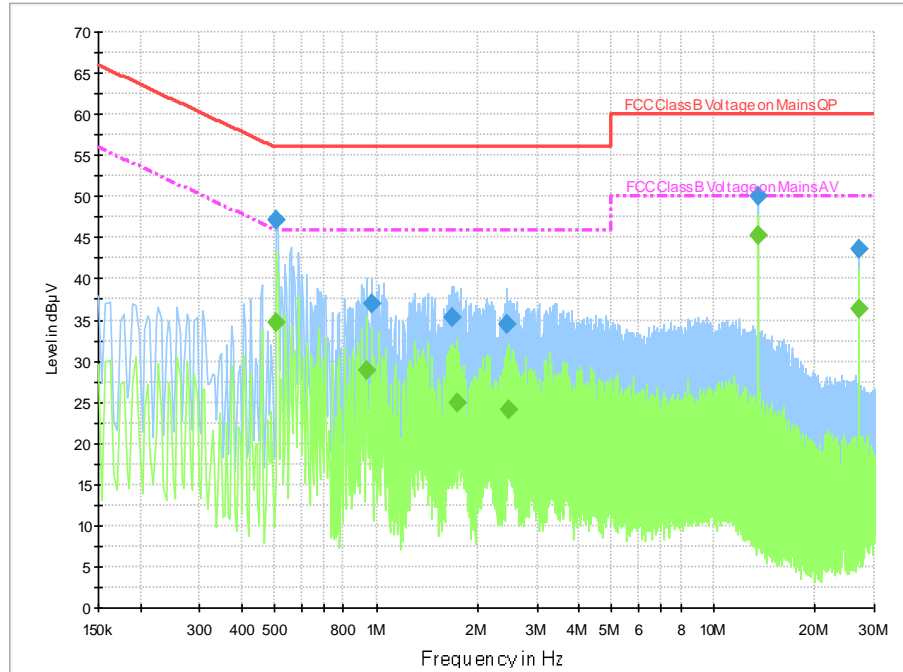

Figure B-11: Measurement results for Conducted Emission

Final Result 1

Frequency (MHz)	QuasiPeak (dBuV)	Meas. Time	Bandwidth (kHz)	Filter	Line	Corr. (dB)	Margin (dB)	Limit (dBuV)
0.506000	47.1	5000.0	9.000	On	L1	19.7	8.9	56.0
0.974000	37.0	5000.0	9.000	On	L1	19.8	19.0	56.0
1.682000	35.4	5000.0	9.000	On	L1	19.6	20.6	56.0
2.438000	34.6	5000.0	9.000	On	L1	19.6	21.4	56.0
13.558000	50.1	5000.0	9.000	On	L1	19.6	9.9	60.0
27.118000	43.6	5000.0	9.000	On	L1	20.1	16.4	60.0

Final Result 2

Frequency (MHz)	QuasiPeak (dBuV)	Meas. Time	Bandwidth (kHz)	Filter	Line	Corr. (dB)	Margin (dB)	Limit (dBuV)
0.506000	34.6	5000.0	9.000	On	L1	19.7	11.4	46.0
0.938000	29.0	5000.0	9.000	On	L1	19.7	17.0	46.0
1.730000	24.9	5000.0	9.000	On	L1	19.6	21.1	46.0
2.482000	24.1	5000.0	9.000	On	L1	19.6	21.9	46.0
13.558000	45.3	5000.0	9.000	On	L1	19.6	4.7	50.0
27.122000	36.4	5000.0	9.000	On	L1	20.1	13.6	50.0

ANNEX C: Persons involved in this testing

Test Item	Tester
20dB Bandwidth	Zhou Bin
Frequency Tolerance	Zhou Bin
Electric Field Strength of Fundamental and Outside the Allocated bands	Ding Zai
Electric Field Radiated Emissions (< 30MHz)	Ding Zai
Electric Field Radiated Emissions (≥ 30 MHz)	Ding Zai
Conducted Emissions	Chen Tianwei

ANNEX D: Accreditation Certificate

<p>United States Department of Commerce National Institute of Standards and Technology</p> <p>NVLAP[®] </p> <hr/> <p>Certificate of Accreditation to ISO/IEC 17025:2017</p> <hr/> <p>NVLAP LAB CODE: 600118-0</p> <p>Telecommunication Technology Labs, CAICT Beijing China</p> <p><i>is accredited by the National Voluntary Laboratory Accreditation Program for specific services, listed on the Scope of Accreditation, for:</i></p> <p>Electromagnetic Compatibility & Telecommunications</p> <p><i>This laboratory is accredited in accordance with the recognized International Standard ISO/IEC 17025:2017. This accreditation demonstrates technical competence for a defined scope and the operation of a laboratory quality management system (refer to joint ISO-ILAC-IAF Communique dated January 2009).</i></p> <hr/> <p>2021-09-29 through 2022-09-30 <i>Effective Dates</i></p> <p style="text-align: center;"></p> <p style="text-align: right;"> <i>For the National Voluntary Laboratory Accreditation Program</i></p>	
---	--

*****END OF REPORT*****