



Test Report No.: W7L-220503W001RF07



VARIANT FCC TEST REPORT

(PART 90)



| | |
|------------|--|
| Applicant: | COOSEA GROUP (HK) COMPANY LIMITED |
| Address: | UNIT 5-6 16/F MULTIFIELD PLAZA 3-7A PRAT AVENUE TSIMSHATSUI KL, HONG KONG, CHINA |

| | |
|--------------------------|--|
| Manufacturer or Supplier | COOSEA GROUP (HK) COMPANY LIMITED |
| Address | UNIT 5-6 16/F MULTIFIELD PLAZA 3-7A PRAT AVENUE TSIMSHATSUI KL, HONG KONG, CHINA |
| Product | LTE Smartphone |
| Brand Name | Cricket |
| Model Name | SL100EA |
| FCC ID | 2A28USL100EA |
| Date of tests | Oct. 27, 2021 ~ Jun. 08, 2022 |

The tests have been carried out according to the requirements of the following standard:

- FCC Part 90, Subpart R, S ANSI/TIA/EIA-603- D
- FCC Part 2 ANSI/TIA/EIA-603-E ANSI C63.26-2015

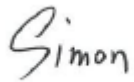
CONCLUSION: The submitted sample was found to COMPLY with the test requirement

| | |
|---|---|
| Prepared by Simon Wang Engineer / Mobile Department | Approved by Luke Lu Manager / Mobile Department |
|  |  |
| Date: Jun. 08, 2022 | Date: Jun. 08, 2022 |

This report is governed by, and incorporates by reference, the Conditions of Testing as posted at the date of issuance of this report at <http://www.bureauveritas.com/home/about-us/our-business/cps/about-us/terms-conditions> and is intended for your exclusive use. Any copying or replication of this report to or for any other person or entity, or use of our name or trademark, is permitted only with our prior written permission. This report sets forth our findings solely with respect to the test samples identified herein. The results set forth in this report are not indicative or representative of the quality or characteristics of the lot from which a test sample was taken or any similar or identical product unless specifically and expressly noted. Our report includes all of the tests requested by you and the results thereof based upon the information that you provided to us. Measurement uncertainty is only provided upon request for accredited tests. Statements of conformity are based on simple acceptance criteria without taking measurement uncertainty into account, unless otherwise requested in writing. You have 60 days from date of issuance of this report to notify us of any material error or omission caused by our negligence or if you require measurement uncertainty; provided, however, that such notice shall be in writing and shall specifically address the issue you wish to raise. A failure to raise such issue within the prescribed time shall constitute your unqualified acceptance of the completeness of this report, the tests conducted and the correctness of the report contents.



TABLE OF CONTENTS

RELEASE CONTROL RECORD 4

1 SUMMARY OF TEST RESULTS 5

1.1 MEASUREMENT UNCERTAINTY 5

1.2 TEST SITE AND INSTRUMENTS 6

2 GENERAL INFORMATION..... 8

2.1 GENERAL DESCRIPTION OF EUT 8

2.2 CONFIGURATION OF SYSTEM UNDER TEST 10

2.3 DESCRIPTION OF SUPPORT UNITS11

2.4 DESCRIPTION OF TEST MODES.....11

2.5 GENERAL DESCRIPTION OF APPLIED STANDARDS 13

3 TEST TYPES AND RESULTS 14

3.1 OUTPUT POWER MEASUREMENT 14

3.1.1 LIMITS OF OUTPUT POWER MEASUREMENT 14

3.1.2 TEST PROCEDURES 14

3.1.3 TEST SETUP 16

3.1.4 TEST RESULTS 17

3.2 FREQUENCY STABILITY MEASUREMENT 21

3.2.1 LIMITS OF FREQUENCY STABILIIITY MEASUREMENT 21

3.2.2 TEST PROCEDURE 21

3.2.3 TEST SETUP 21

3.2.4 TEST RESULTS 22

3.3 OCCUPIED BANDWIDTH MEASUREMENT 23

3.3.1 LIMITS OF OCCUPIED BANDWIDTH MEASUREMENT 23

3.3.2 TEST SETUP 23

3.3.3 TEST PROCEDURES 23

3.3.4 TEST RESULTS 24

3.4 EMISSION MASK MEASUREMENT..... 25

3.4.1 LIMITS OF EMISSION MASK MEASUREMENT 25

3.4.2 TEST SETUP 25

3.4.3 TEST PROCEDURES 26

3.4.4 TEST RESULTS 27

3.5 CONDUCTED SPURIOUS EMISSIONS..... 28

3.5.1 LIMITS OF CONDUCTED SPURIOUS EMISSIONS MEASUREMENT 28

3.5.2 TEST PROCEDURE 28

3.5.3 TEST SETUP 28

3.5.4 TEST RESULTS 29

3.6 RADIATED EMISSION MEASUREMENT 30

3.6.1 LIMITS OF RADIATED EMISSION MEASUREMENT 30

3.6.2 TEST PROCEDURES 30

3.6.3 DEVIATION FROM TEST STANDARD 30

3.6.4 TEST SETUP 31

3.6.5 TEST RESULTS 33

3.7 PEAK TO AVERAGE RATIO 43

3.7.1 LIMITS OF PEAK TO AVERAGE RATIO MEASUREMENT 43

3.7.2 TEST SETUP 43

3.7.3 TEST PROCEDURES 43

3.7.4 TEST RESULTS 44



Test Report No.: W7L-220503W001RF07

| | | |
|---|---|----|
| 4 | INFORMATION ON THE TESTING LABORATORIES | 45 |
| 5 | MODIFICATIONS RECORDERS FOR ENGINEERING CHANGES TO THE EUT BY THE LAB | 46 |
| | APPENDIX A..... | 47 |



Test Report No.: W7L-220503W001RF07

RELEASE CONTROL RECORD

| ISSUE NO. | REASON FOR CHANGE | DATE ISSUED |
|--------------------|--|---------------|
| W7L-P21100025RF07 | Original release | Dec. 24, 2021 |
| W7L-220503W001RF07 | Based on the original report W7L-P21100025RF07 changing SW version and adding 3G function. Verify the RSE, Power worst case. | Jun. 08, 2022 |

1 SUMMARY OF TEST RESULTS

The EUT has been tested according to the following specifications:

| APPLIED STANDARD: FCC Part 90 & Part 2 | | | |
|--|------------------------------|--------|--------------------------------|
| STANDARD SECTION | TEST TYPE AND LIMIT | RESULT | REMARK |
| §2.1046 | Conducted Output Power | PASS | Meet the requirement of limit. |
| §90.635(b) | Maximum Peak Output Power | PASS | Meet the requirement of limit. |
| §2.1055 §90.213 | Frequency Stability | PASS | Meet the requirement of limit. |
| §2.1049 | Occupied Bandwidth | PASS | Meet the requirement of limit. |
| §2.1051 §90.691 | Emission Masks | PASS | Meet the requirement of limit. |
| §2.1051 §90.691 | Conducted Spurious Emissions | PASS | Meet the requirement of limit. |
| §2.1053 §90.691 | Radiated Spurious Emissions | PASS | Meet the requirement of limit. |

Note: Except the data of RSE and power, other data please refer to APPENDIX A

1.1 MEASUREMENT UNCERTAINTY

Where relevant, the following measurement uncertainty levels have been estimated for tests performed on the EUT as specified in CISPR 16-4-2:

| MEASUREMENT | FREQUENCY | UNCERTAINTY |
|---------------------|---------------|-------------|
| Conducted emissions | 9kHz~30MHz | 2.66dB |
| Radiated emissions | 9KHz ~ 30MHz | 2.68dB |
| | 30MHz ~ 1GMHz | 3.26dB |
| | 1GHz ~ 18GHz | 4.48dB |
| | 18GHz ~ 40GHz | 4.12dB |

This uncertainty represents an expanded uncertainty expressed at approximately the 95% confidence level using a coverage factor of k=2.



Test Report No.: W7L-220503W001RF07

1.2 TEST SITE AND INSTRUMENTS

| Equipment | Manufacturer | Model No. | Serial No. | Last Cal. | Next Cal. |
|---------------------------------------|--------------|-----------------------------|------------------------------|-------------|-------------|
| MXE EMI Receiver | KEYSIGHT | N9038A-544 | MY54450026 | Apr. 22,21 | Apr. 21,22 |
| MXE EMI Receiver | KEYSIGHT | N9038A-544 | MY54450026 | Apr. 21,22 | Apr. 20,23 |
| EXA Signal Analyzer | KEYSIGHT | N9010A-544 | MY54510355 | Jun. 03,21 | Jun. 02,22 |
| EXA Signal Analyzer | KEYSIGHT | N9010A-544 | MY54510355 | Jun. 02,22 | Jun. 01,23 |
| Loop Antenna | Schwarzbeck | FMZB 1519B | 1519B-051 | Feb. 14,20 | Feb. 13,23 |
| Bilog Antenna | ETS-LINDGREN | 3143B | 00161965 | Mar. 05,21 | Mar. 04,22 |
| Bilog Antenna | ETS-LINDGREN | 3143B | 00161965 | Mar. 04,22 | Mar. 03,23 |
| Horn Antenna | ETS-LINDGREN | 3117 | 00168692 | Apr. 02,21 | Apr. 01,22 |
| Horn Antenna | ETS-LINDGREN | 3117 | 00168692 | Apr. 01,22 | Mar. 31,23 |
| Horn Antenna (18GHz-40GHz) | N/A | QWH-SL-18-40-K-SG/QMS-00361 | 15433 | Aug. 25, 21 | Aug. 24, 22 |
| Radio Communication Analyzer | ANRITSU | MT8820C | 6201465426 | Feb. 25,21 | Feb. 24,22 |
| Radio Communication Analyzer | ANRITSU | MT8820C | 6201465426 | Feb. 24,22 | Feb. 23,23 |
| Signal Pre-Amplifier | EMSI | EMC 9135 | 980249 | Jun. 02,21 | Jun. 01,22 |
| Signal Pre-Amplifier | EMSI | EMC 9135 | 980249 | Jun. 01,22 | May. 31,23 |
| Signal Pre-Amplifier | EMSI | EMC 012645B | 980257 | Jun. 03,21 | Jun. 02,22 |
| Signal Pre-Amplifier | EMSI | EMC 012645B | 980257 | Jun. 02,22 | Jun. 01,23 |
| Signal Pre-Amplifier | EMSI | EMC 184045B | 980259 | Apr. 22,21 | Apr. 21,22 |
| Signal Pre-Amplifier | EMSI | EMC 184045B | 980259 | Apr. 21,22 | Apr. 20,23 |
| 3m Semi-anechoic Chamber | ETS-LINDGREN | 9m*6m*6m | Euroshieldpn-C T0001143-1216 | May. 19,20 | May. 18,23 |
| Test Software | E3 | V 9.160323 | N/A | N/A | N/A |
| Test Software | ADT | ADT_Radiated_V 7.6.15.9.2 | N/A | N/A | N/A |
| 10dB Attenuator | JFW/USA | 50HF-010-SMA | 1505 | Jun. 03,21 | Jun. 02,22 |
| 10dB Attenuator | JFW/USA | 50HF-010-SMA | 1505 | Jun. 02,22 | Jun. 01,23 |
| Power Meter | Anritsu | ML2495A | 1506002 | Apr. 07,21 | Apr. 06,22 |
| Power Meter | Anritsu | ML2495A | 1506002 | Apr. 06,22 | Apr. 05,23 |
| Power Sensor | Anritsu | MA2411B | 1339352 | May. 07,21 | May. 06,22 |
| Power Sensor | Anritsu | MA2411B | 1339352 | May. 06,22 | May. 05,23 |
| Temperature Chamber | ESPEC | SH-242 | 93000855 | Jun. 02,21 | Jun. 01,22 |
| Temperature Chamber | ESPEC | SH-242 | 93000855 | Jun. 01,22 | May. 31,23 |
| MXG Analog Microwave Signal Generator | KEYSIGHT | N5183A | MY50143024 | Mar. 05,21 | Mar. 04,22 |
| MXG Analog Microwave Signal Generator | KEYSIGHT | N5183A | MY50143024 | Mar. 04,22 | Mar. 03,23 |
| Power Divider | MCLI/USA | PS2-15 | 24880 | N/A | N/A |



Test Report No.: W7L-220503W001RF07

- NOTE:**
1. The calibration interval of the above test instruments is 12 months or 36 months and the calibrations are traceable to CEPREI/CHINA, GRGT/CHINA and NIM/CHINA.
 2. The test was performed in 3m Semi-anechoic Chamber and RF Oven Room.
 3. The horn antenna is used only for the measurement of emission frequency above 1GHz if tested.
 4. The FCC Site Registration No. is 525120.

2 GENERAL INFORMATION

2.1 GENERAL DESCRIPTION OF EUT

| | | |
|------------------------------|--|---------------------|
| PRODUCT | LTE Smartphone | |
| BRAND NAME | Cricket | |
| MODEL NAME | SL100EA | |
| NOMINAL VOLTAGE | 5.0Vdc(adapter or host equipment) 3.85Vdc (Li-ion, battery) | |
| MODULATION TECHNOLOGY | LTE | QPSK, 16QAM, 64QAM |
| FREQUENCY RANGE | LTE Band 14 Channel Bandwidth: 5MHz | 790.5MHz ~ 795.5MHz |
| | LTE Band 14 Channel Bandwidth: 10MHz | 793MHz |
| EMISSION DESIGNATOR | LTE Band 14 Channel Bandwidth: 5MHz | QPSK: 4M59G7D |
| | | 16QAM: 4M60W7D |
| | | 64QAM: 4M58W7D |
| | LTE Band 14 Channel Bandwidth: 10MHz | QPSK: 9M10G7D |
| | | 16QAM: 9M08W7D |
| | | 64QAM: 9M09W7D |
| MAX. EIRP POWER | LTE Band 14 Channel Bandwidth: 5MHz | 95.06mW |
| | LTE Band 14 Channel Bandwidth: 10MHz | 95.28mW |
| ANTENNA TYPE | PIFA Antenna with -1.9dBi gain for LTE B14 | |
| HW VERSION | 1.0 | |
| SW VERSION | SL100EAC20101 | |
| I/O PORTS | Refer to user's manual | |
| CABLE SUPPLIED | USB cable: unshielded without ferrite, 1.0meter | |
| EXTREME TEMPERATURE | -10-55 °C | |
| EXTREME VOLTAGE | 3.6V - 4.4V | |

NOTE:

- For a more detailed features description, please refer to the manufacturer's specifications or the user's manual.
- For the test results, the EUT had been tested with all conditions. But only the worst case was shown in test report.



Test Report No.: W7L-220503W001RF07

List of Accessory:

| ACCESSORIES | BRAND | MANUFACTURER | MODEL | SPECIFICATION |
|-------------|--------|---|-------------------|---|
| Battery | COOSEA | ZHONGSHAN TIANMAO BATTERY CO., LTD | BL-A32CT | Capacity : 3.85 Vdc, 3450mAh |
| AC Adapter | COOSEA | Guangdong Beicom Electronics Co., Ltd. | U312E0A05020 0 | I/P:100-240V,50/60Hz,0.35A, O/P: 5.0V,2.0A 10.0W |
| USB Cable | COOSEA | Wivtak | TP-C0028-B3 | Signal Line, 1.0meter |

2.2 CONFIGURATION OF SYSTEM UNDER TEST

FOR RADIATION EMISSION TEST

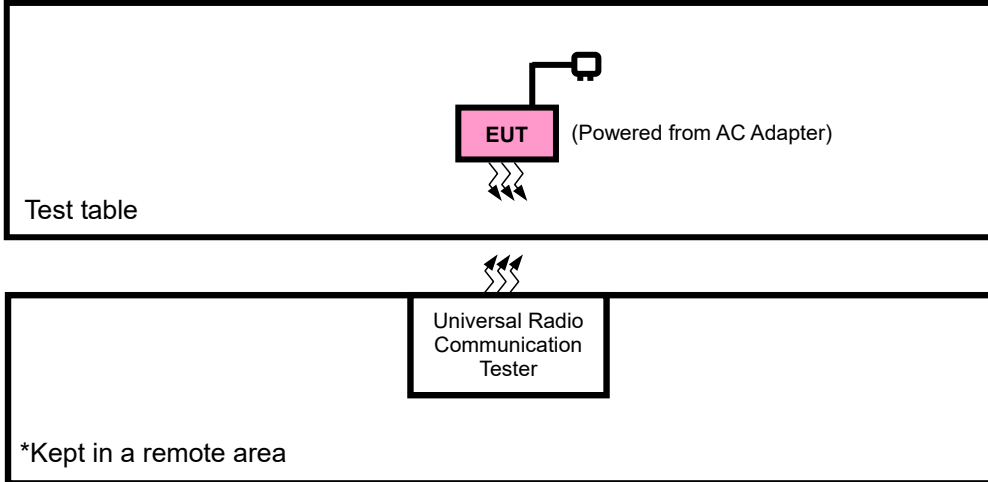

FOR CONDUCTED & E.R.P./E.I.R.P TEST

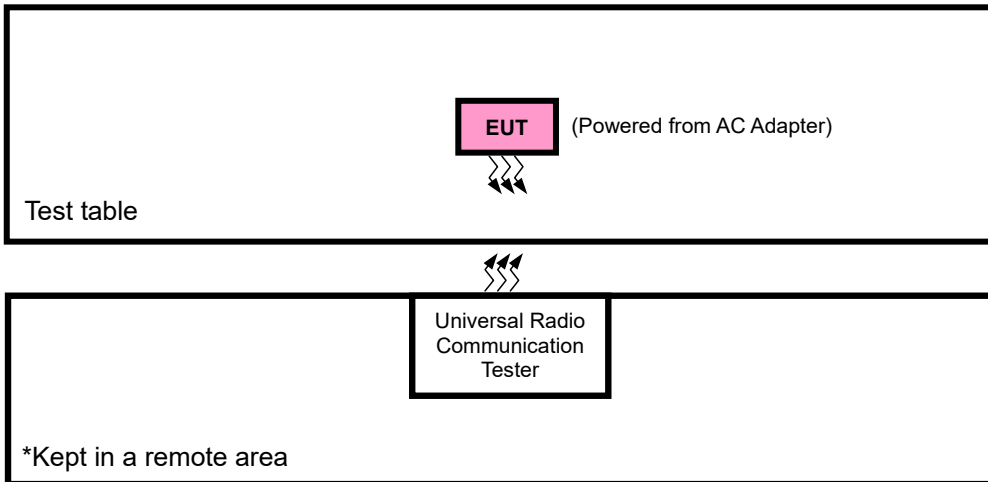



2.3 DESCRIPTION OF SUPPORT UNITS

The EUT has been tested as an independent unit together with other necessary accessories or support units. The following support units or accessories were used to form a representative test configuration during the tests.

| NO. | PRODUCT | BRAND | MODEL NO. | SERIAL NO. | FCC ID |
|-----|-----------|----------|-----------|------------|--------|
| 1 | DC source | LONG WEI | PS-6403D | 010934269 | N/A |

| NO. | SIGNAL CABLE DESCRIPTION OF THE ABOVE SUPPORT UNITS |
|-----|---|
| 1 | DC Line: Unshielded, Detachable 1.0m |

2.4 DESCRIPTION OF TEST MODES

Pre-Scan has been conducted to determine the worst-case mode from all possible combinations between available modulations, data rates, XYZ axis and antenna ports. The worst case in ERP/EIRP and radiated emission was found when positioned on X-plane for LTE. Following channel(s) was (were) selected for the final test as listed below:

| DESCRIPTION |
|---|
| EUT + Adapter + USB Cable + with LTE link |



Test Report No.: W7L-220503W001RF07

LTE BAND 14 MODE

| TEST ITEM | AVAILABLE CHANNEL | TESTED CHANNEL | CHANNEL BANDWIDTH | MODULATION | MODE | |
|---------------------|--------------------|---------------------|---------------------|--------------------|--|--------------------|
| ERP | 23305 to 23355 | 23305, 23330, 23355 | 5MHz | QPSK, 16QAM, 64QAM | 1 RB / 0 RB Offset | |
| | 23330 | 23330 | 10MHz | QPSK, 16QAM, 64QAM | 1 RB / 0 RB Offset | |
| FREQUENCY STABILITY | 23305 to 23355 | 23305, 23355 | 5MHz | QPSK, 16QAM, 64QAM | 1 RB / 0 RB Offset | |
| | 23330 | 23330 | 10MHz | QPSK, 16QAM, 64QAM | 1 RB / 0 RB Offset | |
| OCCUPIED BANDWIDTH | 23305 to 23355 | 23305, 23330, 23355 | 5MHz | QPSK, 16QAM, 64QAM | 25 RB / 0 RB Offset | |
| | 23330 | 23330 | 10MHz | QPSK, 16QAM, 64QAM | 50 RB / 0 RB Offset | |
| BAND EDGE | 23305 to 23355 | 23305 | 5MHz | QPSK, 16QAM, 64QAM | 1 RB / 0 RB Offset 25 RB / 0 RB Offset | |
| | | 23355 | 5MHz | QPSK, 16QAM, 64QAM | 1 RB / 24 RB Offset 25 RB / 0 RB Offset | |
| | 23300 | 23330 | 10MHz | QPSK, 16QAM, 64QAM | 1 RB / 0 RB Offset 50 RB / 0 RB Offset | |
| | | / | 10MHz | QPSK, 16QAM, 64QAM | 1 RB / 49 RB Offset 50 RB / 0 RB Offset | |
| | CONDCUDED EMISSION | 23305 to 23355 | 23305, 23330, 23355 | 5MHz | QPSK, 16QAM, 64QAM | 1 RB / 0 RB Offset |
| | | 23330 | 23330 | 10MHz | QPSK, 16QAM, 64QAM | 1 RB / 0 RB Offset |
| RADIATED EMISSION | 23305 to 23355 | 23305, 23330, 23355 | 5MHz | QPSK | 1 RB / 0 RB Offset | |
| | 23330 | 23330 | 10MHz | QPSK | 1 RB / 0 RB Offset | |

Note: This device was tested under all bandwidths, RB configurations and modulations. The worst case was found in QPSK modulation.



Test Report No.: W7L-220503W001RF07

TEST CONDITION:

| TEST ITEM | ENVIRONMENTAL CONDITIONS | INPUT POWER | TESTED BY |
|---------------------|--------------------------|--------------------------|-----------|
| EIRP(ERP) | 24deg. C, 60%RH | DC 5V By Adapter | Star Le |
| FREQUENCY STABILITY | 24deg. C, 61%RH | 3.5/3.85/4.4V By Battery | Jaems Fu |
| OCCUPIED BANDWIDTH | 24deg. C, 61%RH | DC5V By Adapter | Jaems Fu |
| BAND EDGE | 24deg. C, 61%RH | DC 5V By Adapter | Jaems Fu |
| CONDCUDED EMISSION | 24deg. C, 61%RH | DC5V By Adapter | Jaems Fu |
| RADIATED EMISSION | 23deg. C, 70%RH | DC5V By Adapter | Star Le |

2.5 GENERAL DESCRIPTION OF APPLIED STANDARDS

The EUT is a RF product. According to the specifications of the manufacturer, it must comply with the requirements of the following standards:

FCC 47 CFR Part 2

FCC 47 CFR Part 90

ANSI/TIA/EIA-603-D

ANSI/TIA/EIA-603-E

ANSI C63.26-2015

NOTE: All test items have been performed and recorded as per the above standards.



3 TEST TYPES AND RESULTS

3.1 OUTPUT POWER MEASUREMENT

3.1.1 LIMITS OF OUTPUT POWER MEASUREMENT

Per FCC Part 90.635(a)(b)

The maximum output power of the transmitter for mobile stations is 100 watts (20 dBw).

3.1.2 TEST PROCEDURES

EIRP / ERP MEASUREMENT:

- a. The EUT was set up for the maximum power with LTE link data modulation. The power was measured with R&S Spectrum Analyzer. All measurements were done at 3 channels (low, middle and high operational frequency range). RBW and VBW is 10MHz for LTE.
- b. E.I.R.P power measurement. In the semi-anechoic chamber, EUT placed on the 0.8m height of Turn Table, rotated the table around 360 degrees to search the maximum radiation power and receiver antenna shall be rotated vertical and horizontal polarization and moved height from 1m to 4m to find the maximum polar radiated power. The "Read Value" is the spectrum reading the maximum power value.
- c. The substitution horn antenna is substituted for EUT at the same position and signals generator export the CW signal to the substitution antenna via a TX cable. Rotated the Turn Table and moved receiving antenna to find the maximum radiation power. Adjust output power level of S.G to get a Value of spectrum reading equal to "Read Value" of step a. Record the power level of S.G



Test Report No.: W7L-220503W001RF07

- d. EIRP = Output power level of S.G – TX cable loss + Antenna gain of substitution horn

Per KDB 971168 D01 Power Meas License Digital Systems v03r01 or subclause 5.2.5.5 of ANSI C63.26-2015, the relevant equation for determining the ERP or EIRP from the conducted RF output power measured using the guidance provided above is:

$$\text{ERP or EIRP} = P_{\text{Meas}} + G_{\text{T}} - L_{\text{C}}$$

Where:

ERP or EIRP = effective radiated power or equivalent isotropically radiated power, respectively
(expressed in the same units as P_{Meas} , typically dBW or dBm);

P_{Meas} = measured transmitter output power or PSD, in dBm or dBW;

G_{T} = gain of the transmitting antenna, in dBd (ERP) or dBi (EIRP);

L_{C} = signal attenuation in the connecting cable between the transmitter and antenna, in dB.

- e. E.R.P = E.I.R.P- 2.15 dB

CONDUCTED POWER MEASUREMENT:

- The EUT was set up for the maximum power with LTE link data modulation and link up with simulator.
- Set the EUT to transmit under low, middle and high channel and record the power level shown on simulator.

3.1.3 TEST SETUP

ERP MEASUREMENT:

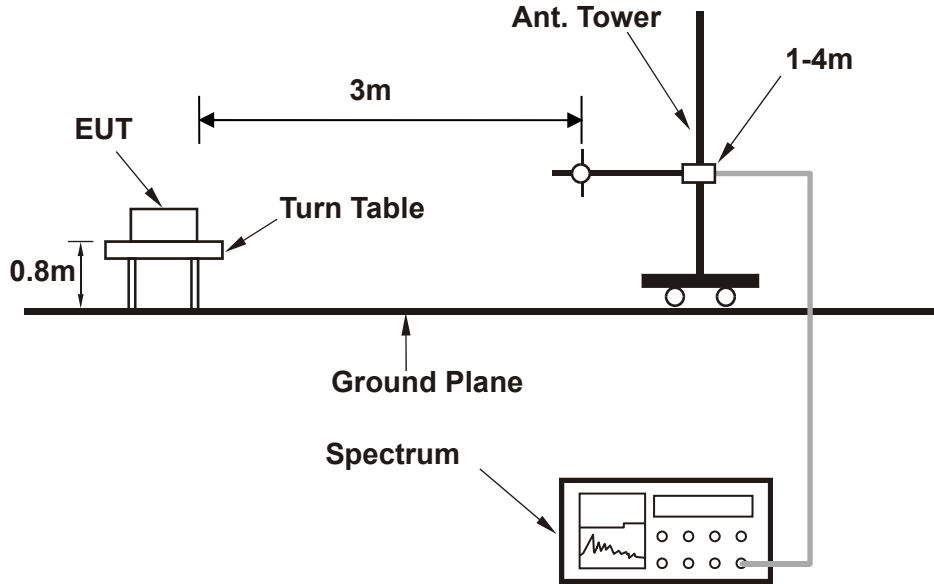

EIRP MEASUREMENT:

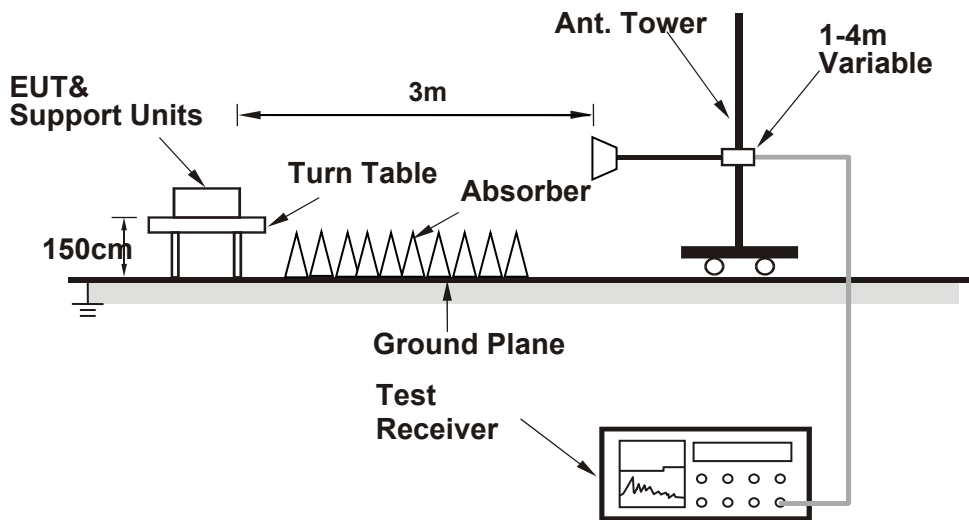

For the actual test configuration, please refer to the attached file (Test Setup Photo).

CONDUCTED POWER MEASUREMENT:

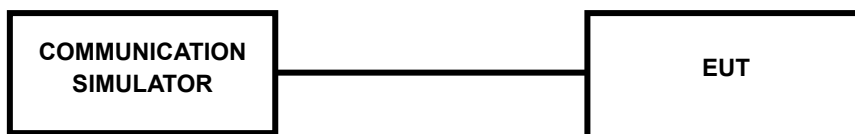

For the actual test configuration, please refer to the attached file (Test Setup Photo).



**BUREAU
VERITAS**

Test Report No.: W7L-220503W001RF07

3.1.4 TEST RESULTS

AVERAGE CONDUCTED OUTPUT POWER (dBm)

LTE Band 14

| Band/BW | Modulation | RB Size | RB Offset | Low CH 23305 | Mid CH 23330 | High CH 23355 | MPR |
|---------|------------|---------|-----------|------------------------|----------------------|------------------------|-----|
| | | | | Frequency 790.5 MHz | Frequency 793 MHz | Frequency 795.5 MHz | |
| 14/ 5 | QPSK | 1 | 0 | 23.54 | 23.61 | 23.57 | 0 |
| | | 1 | 12 | 23.80 | 23.79 | 23.83 | 0 |
| | | 1 | 24 | 23.61 | 23.65 | 23.62 | 0 |
| | | 12 | 0 | 22.58 | 22.60 | 22.63 | 1 |
| | | 12 | 6 | 22.53 | 22.59 | 22.56 | 1 |
| | | 12 | 13 | 22.56 | 22.50 | 22.56 | 1 |
| | | 25 | 0 | 22.55 | 22.57 | 22.55 | 1 |
| | 16QAM | 1 | 0 | 22.52 | 22.56 | 22.52 | 1 |
| | | 1 | 12 | 22.72 | 22.74 | 22.77 | 1 |
| | | 1 | 24 | 23.58 | 23.57 | 23.59 | 1 |
| | | 12 | 0 | 21.69 | 21.71 | 21.74 | 2 |
| | | 12 | 6 | 21.62 | 21.68 | 21.64 | 2 |
| | | 12 | 13 | 21.59 | 21.66 | 21.65 | 2 |
| | | 25 | 0 | 21.67 | 21.66 | 21.63 | 2 |
| | 64QAM | 1 | 0 | 21.35 | 21.42 | 21.41 | 2 |
| | | 1 | 12 | 21.64 | 21.63 | 21.60 | 2 |
| | | 1 | 24 | 21.49 | 21.53 | 21.52 | 2 |
| | | 12 | 0 | 20.68 | 20.70 | 20.73 | 3 |
| | | 12 | 6 | 20.60 | 20.66 | 20.63 | 3 |
| | | 12 | 13 | 20.69 | 20.63 | 20.69 | 3 |
| | | 25 | 0 | 20.73 | 20.75 | 20.73 | 3 |



Test Report No.: W7L-220503W001RF07

| Band/BW | Modulation | RB Size | RB Offset | | Mid CH 23330 | | MPR |
|---------|------------|---------|-----------|--|-------------------|--|-----|
| | | | | | Frequency 793 MHz | | |
| 14/ 10 | QPSK | 1 | 0 | | 23.62 | | 0 |
| | | 1 | 24 | | 23.84 | | 0 |
| | | 1 | 49 | | 23.67 | | 0 |
| | | 25 | 0 | | 22.65 | | 1 |
| | | 25 | 12 | | 22.61 | | 1 |
| | | 25 | 25 | | 22.58 | | 1 |
| | | 50 | 0 | | 22.63 | | 1 |
| | 16QAM | 1 | 0 | | 22.58 | | 1 |
| | | 1 | 24 | | 22.79 | | 1 |
| | | 1 | 49 | | 23.64 | | 1 |
| | | 25 | 0 | | 21.76 | | 2 |
| | | 25 | 12 | | 21.70 | | 2 |
| | | 25 | 25 | | 21.67 | | 2 |
| | | 50 | 0 | | 21.71 | | 2 |
| | 64QAM | 1 | 0 | | 21.43 | | 2 |
| | | 1 | 24 | | 21.68 | | 2 |
| | | 1 | 49 | | 21.55 | | 2 |
| | | 25 | 0 | | 20.75 | | 3 |
| | | 25 | 12 | | 20.68 | | 3 |
| | | 25 | 25 | | 20.71 | | 3 |
| | | 50 | 0 | | 20.81 | | 3 |

ERP

LTE BAND 14

CHANNEL BANDWIDTH: 5MHz QPSK

| Channel | Frequency (MHz) | Conducted Power (dBm) | G _T -L _c (dB) | ERP (dBm) | ERP (mW) | Limit (W) |
|---------|-----------------|-----------------------|-------------------------------------|-----------|----------|-----------|
| 23305 | 790.5 | 23.8 | -1.9 | 19.75 | 94.41 | 3 |
| 23330 | 793 | 23.79 | -1.9 | 19.74 | 94.19 | 3 |
| 23355 | 795.5 | 23.83 | -1.9 | 19.78 | 95.06 | 3 |

CHANNEL BANDWIDTH: 5MHz 16QAM

| Channel | Frequency (MHz) | Conducted Power (dBm) | G _T -L _c (dB) | ERP (dBm) | ERP (mW) | Limit (W) |
|---------|-----------------|-----------------------|-------------------------------------|-----------|----------|-----------|
| 23305 | 790.5 | 23.58 | -1.9 | 19.53 | 89.74 | 3 |
| 23330 | 793 | 23.57 | -1.9 | 19.52 | 89.54 | 3 |
| 23355 | 795.5 | 23.59 | -1.9 | 19.54 | 89.95 | 3 |

CHANNEL BANDWIDTH: 5MHz 64QAM

| Channel | Frequency (MHz) | Conducted Power (dBm) | G _T -L _c (dB) | ERP (dBm) | ERP (mW) | Limit (W) |
|---------|-----------------|-----------------------|-------------------------------------|-----------|----------|-----------|
| 23305 | 790.5 | 21.64 | -1.9 | 17.59 | 57.41 | 3 |
| 23330 | 793 | 21.63 | -1.9 | 17.58 | 57.28 | 3 |
| 23355 | 795.5 | 21.6 | -1.9 | 17.55 | 56.89 | 3 |

CHANNEL BANDWIDTH: 10MHz QPSK

| Channel | Frequency (MHz) | Conducted Power (dBm) | G _T -L _c (dB) | ERP (dBm) | ERP (mW) | Limit (W) |
|---------|-----------------|-----------------------|-------------------------------------|-----------|----------|-----------|
| - | - | - | - | - | - | - |
| 23330 | 793 | 23.84 | -1.9 | 19.79 | 95.28 | 3 |
| - | - | - | - | - | - | - |

CHANNEL BANDWIDTH: 10MHz 16QAM

| Channel | Frequency (MHz) | Conducted Power (dBm) | G _T -L _c (dB) | ERP (dBm) | ERP (mW) | Limit (W) |
|---------|-----------------|-----------------------|-------------------------------------|-----------|----------|-----------|
| - | - | - | - | - | - | - |
| 23330 | 793 | 23.64 | -1.9 | 19.59 | 90.99 | 3 |
| - | - | - | - | - | - | - |



Test Report No.: W7L-220503W001RF07

CHANNEL BANDWIDTH: 10MHz 64QAM

| Channel | Frequency (MHz) | Conducted Power (dBm) | G _T -L _c (dB) | ERP (dBm) | ERP (mW) | Limit (W) |
|---------|-----------------|-----------------------|-------------------------------------|-----------|----------|-----------|
| - | - | - | - | - | - | - |
| 23330 | 793 | 21.68 | -1.9 | 17.63 | 57.94 | 3 |
| - | - | - | - | - | - | - |

REMARKS: ERP Output Power (dBm) = ERP (dBm) -2.15(dB).

3.2 FREQUENCY STABILITY MEASUREMENT

3.2.1 LIMITS OF FREQUENCY STABILITY MEASUREMENT

The frequency stability of mobile, portable and control transmitters operating in the wideband segment must be 1.25 parts per million or better when AFC is locked to a base station, and 5 parts per million or better when AFC is not locked

3.2.2 TEST PROCEDURE

- a. Device is placed at the oven room. The oven room could control the temperatures and humidity. Power warm up is at least 15 min and power applied should perform before recording frequency error.
- b. EUT is connected the external power supply to control the DC input power. The test voltage range is from minimum to maximum working voltage. Each step shall be record the frequency error rate.
- c. The temperature range step is 10 degrees in this test items. All temperature levels shall be hold the $\pm 0.5^{\circ}\text{C}$ during the measurement testing. The each temperature step shall be at least 0.5 hours, consider the EUT could be test under the stability condition.

NOTE: The frequency error was recorded frequency error from the communication simulator.

3.2.3 TEST SETUP

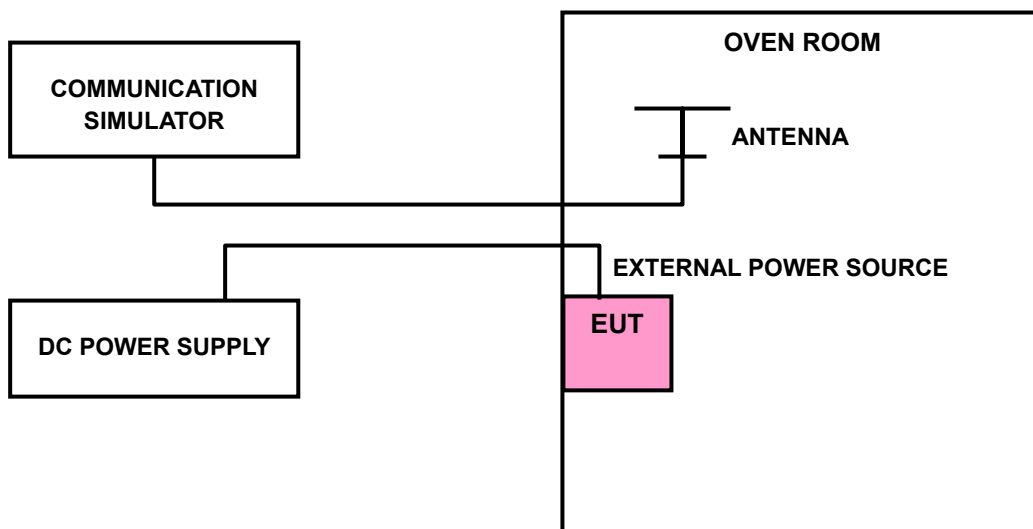



Test Report No.: W7L-220503W001RF07

3.2.4 TEST RESULTS

Please Refer to Appendix A Of this test report.

3.3 OCCUPIED BANDWIDTH MEASUREMENT

3.3.1 LIMITS OF OCCUPIED BANDWIDTH MEASUREMENT

The width of a frequency band such that, below the lower and above the upper frequency limits, the mean powers emitted are each equal to a specified percentage 0.5 %of the total mean power of a given emission.

3.3.2 TEST SETUP

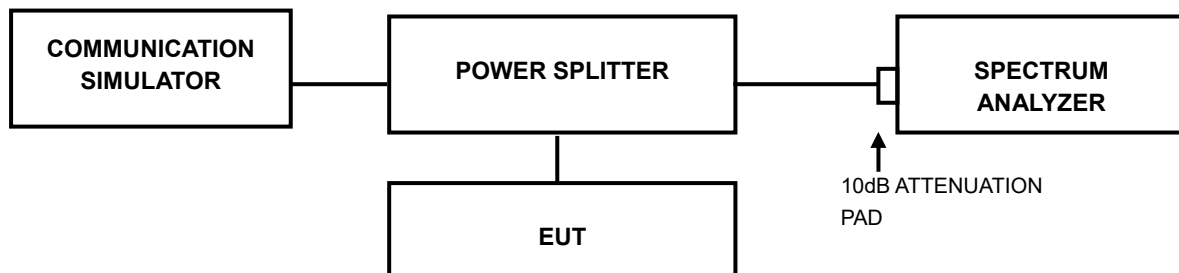

3.3.3 TEST PROCEDURES

- a. The conducted occupied bandwidth used the power splitter via EUT RF power connector between simulation base station and spectrum analyzer.
- b. Use OBW measurement function of Spectrum analyzer to measure 99 % occupied bandwidth.



Test Report No.: W7L-220503W001RF07

3.3.4 TEST RESULTS

Please Refer to Appendix A Of this test report.

3.4 EMISSION MASK MEASUREMENT

3.4.1 LIMITS OF EMISSION MASK MEASUREMENT

According to FCC part 90.691 shall be tested the emission mask. For any frequency removed from the EA licensee's frequency block by up to and including 37.5 kHz, the power of any emission shall be attenuated below the transmitter power (P) in watts by at least $116 \log_{10}(f/6.1)$ decibels or $50 + 10 \log_{10}(P)$ decibels or 80 decibels, whichever is the lesser attenuation, where f is the frequency removed from the center of the outer channel in the block in kilohertz and where f is greater than 12.5 kHz.

3.4.2 TEST SETUP

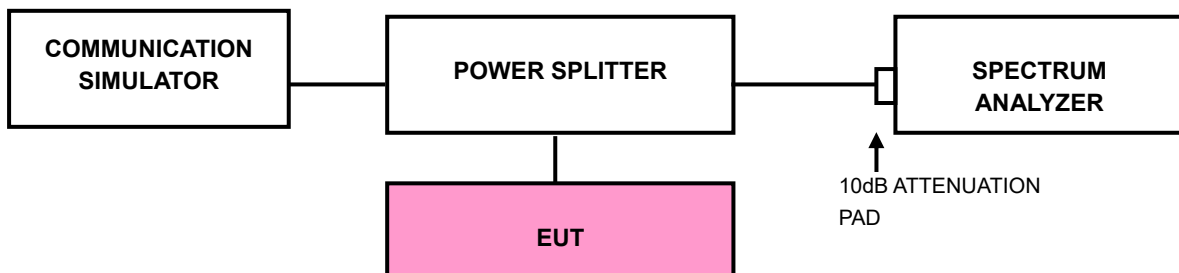



Test Report No.: W7L-220503W001RF07

3.4.3 TEST PROCEDURES

- a. All measurements were done at low and high operational frequency range.
- b. The center frequency of spectrum is the band edge frequency and span is 1~5 MHz.
- c. RBW of the spectrum is 10kHz and VBW of the spectrum is 30kHz (GSM/GPRS/EDGE/LTE bandwidth for (1.4M/3M/5M/10M/15M/20M)1RB/0RB&1RB/MAXRB).
- d. The center frequency of spectrum is the band edge frequency and span is 10MHz. RBW of the spectrum is 100kHz and VBW of the spectrum is 300kHz (WCDMA).
- e. The center frequency of spectrum is the band edge frequency and span is 1~5 MHz. RBW of the spectrum is $\geq 1\% \cdot \text{EBW}$ kHz and VBW of the spectrum is $3 \cdot \text{RBW}$ kHz. (LTE bandwidth 1.4M/3M/5M/10M/15M/20MHz).
- f. Record the max trace plot into the test report.



Test Report No.: W7L-220503W001RF07

3.4.4 TEST RESULTS

Please Refer to Appendix A Of this test report.

3.5 CONDUCTED SPURIOUS EMISSIONS

3.5.1 LIMITS OF CONDUCTED SPURIOUS EMISSIONS MEASUREMENT

The power of any emission outside a licensee's frequency block shall be attenuated below the transmitter power (P) by at least $43 + 10 \log_{10}(P)$ dB. The limit of emission equal to -13dBm

3.5.2 TEST PROCEDURE

- a. The EUT makes a phone call to the communication simulator. All measurements were done at middle operational frequency range.
- b. Measuring frequency range is from 9kHz up to a frequency including its 10th harmonic. 10dB attenuation pad is connected with spectrum. RBW=1MHz and VBW=3MHz are used for conducted emission measurement.

3.5.3 TEST SETUP

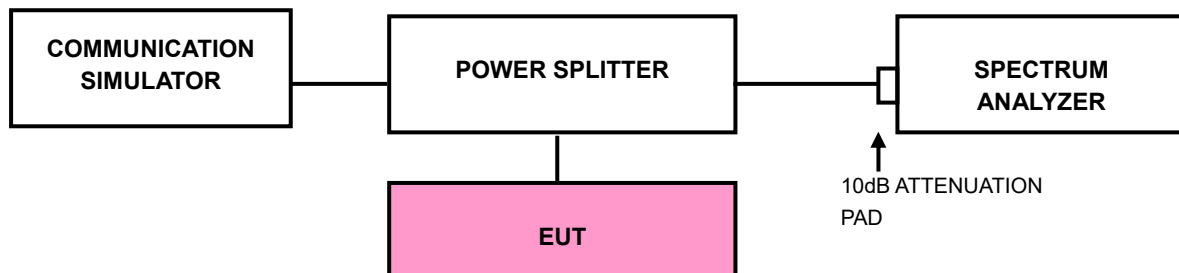



Test Report No.: W7L-220503W001RF07

3.5.4 TEST RESULTS

NOTE : The 9K~30MHz amplitude of spurious emissions attenuated more than 20 dB below the permissible value is not required in the report.

Please Refer to Appendix A Of this test report.



3.6 RADIATED EMISSION MEASUREMENT

3.6.1 LIMITS OF RADIATED EMISSION MEASUREMENT

(1) The power of any emission outside a licensee's frequency block shall be attenuated below the transmitter power (P) by at least $43 + 10 \log_{10}(P)$ dB. The limit of emission equal to -13dBm

(2) For operations in the 763–775 MHz and 793–805 MHz bands, all emissions including harmonics in the band 1559–1610 MHz shall be limited to -70 dBW/MHz equivalent isotropically radiated power (EIRP) for wideband signals, and -80 dBW EIRP for discrete emissions of less than 700 Hz bandwidth. For the purpose of equipment authorization, a transmitter shall be tested with an antenna that is representative of the type that will be used with the equipment in normal operation.

3.6.2 TEST PROCEDURES

- a. Substitution method is used for E.I.R.P measurement. In the semi-anechoic chamber, EUT placed on the 0.8m height of Turn Table, rotated the table around 360 degrees to search the maximum radiation power and receiver antenna shall be rotated vertical and horizontal polarization and moved height from 1m to 4m to find the maximum polar radiated power. The “Read Value” is the spectrum reading the maximum power value.
- b. The substitution horn antenna is substituted for EUT at the same position and signals generator export the CW signal to the substitution antenna via a TX cable. Rotated the Turn Table and moved receiving antenna to find the maximum radiation power. Adjust output power level of S.G to get a Value of spectrum reading equal to “Read Value” of step a. Record the power level of S.G
- c. $\text{EIRP} = \text{Output power level of S.G} - \text{TX cable loss} + \text{Antenna gain of substitution horn.}$
- d. E.R.P power can be calculated form E.I.R.P power by subtracting the gain of dipole, $\text{E.R.P power} = \text{E.I.P.R power} - 2.15\text{dBi.}$

NOTE: The resolution bandwidth of spectrum analyzer is 1 MHz and the video bandwidth is 3 MHz.

3.6.3 DEVIATION FROM TEST STANDARD

No deviation

3.6.4 TEST SETUP

<Below 30MHz>

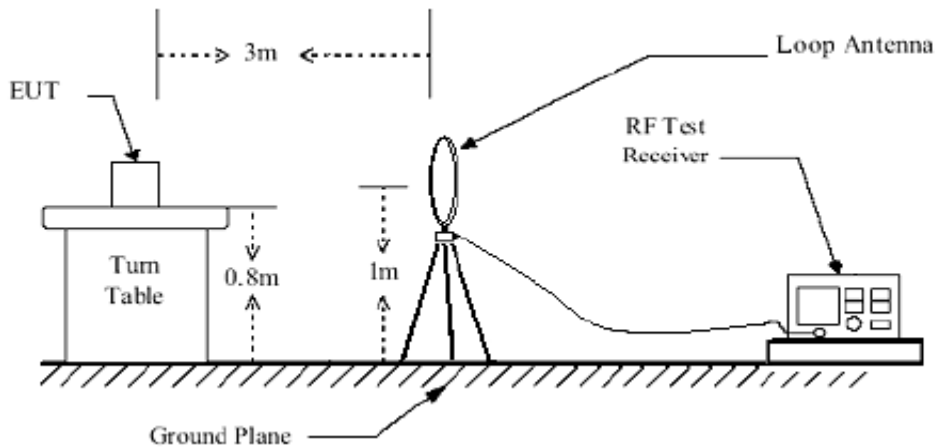

< Frequency Range 30MHz~1GHz >

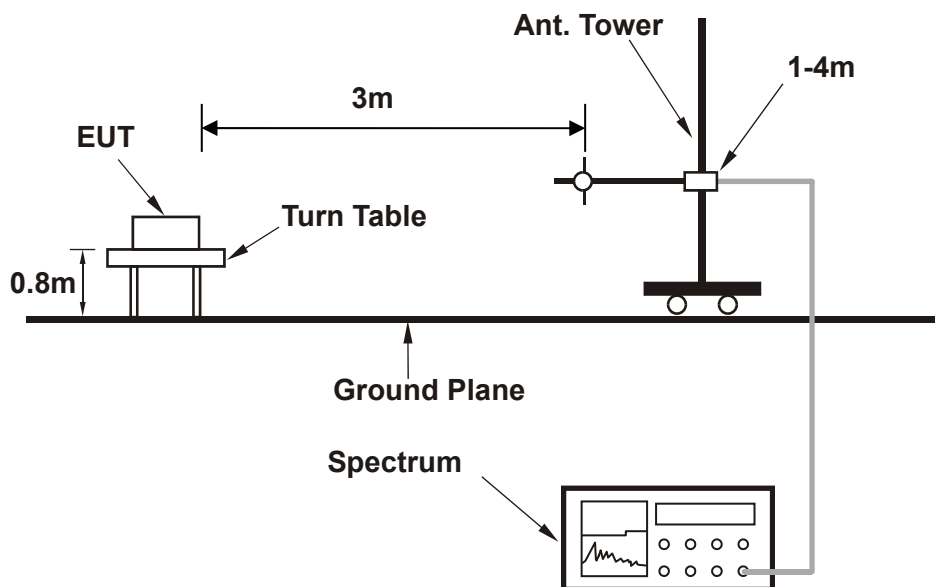

< Frequency Range above 1GHz >

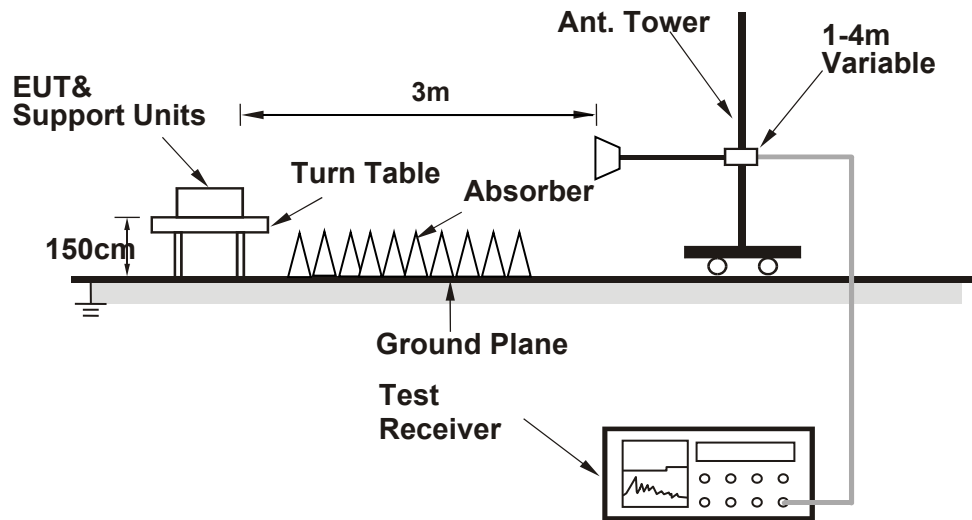

For the actual test configuration, please refer to the attached file (Test Setup Photo).



Test Report No.: W7L-220503W001RF07

3.6.5 TEST RESULTS

NOTE : The 9K~30MHz amplitude of spurious emissions attenuated more than 20 dB below the permissible value is not required in the report.

BELOW 1GHz WORST-CASE DATA

30 MHz – 1GHz data:

LTE Band 14:

CHANNEL BANDWIDTH: 5MHz / QPSK

| | | | |
|--|------------------|-----------------|---------------|
| MODE | TX channel 23330 | FREQUENCY RANGE | Below 1000MHz |
| ENVIRONMENTAL CONDITIONS | 23deg. C, 70%RH | INPUT POWER | AC120V/60Hz |
| TESTED BY | Jace HU | | |
| ANTENNA POLARITY & TEST DISTANCE: HORIZONTAL AT 3 M | | | |

| | Freq | Level | Read Level | Limit Line | Over Limit | Factor | Remark | PoI/Phase |
|---|---------|--------|------------|------------|------------|--------|--------|------------|
| | MHz | dBm/m | dBm | dBm/m | dB | dB/m | | |
| 1 | 63.950 | -33.23 | -41.84 | -13.00 | -20.23 | 8.61 | Peak | Horizontal |
| 2 | 164.830 | -26.81 | -37.83 | -13.00 | -13.81 | 11.02 | Peak | Horizontal |
| 3 | 263.770 | -34.72 | -48.36 | -13.00 | -21.72 | 13.64 | Peak | Horizontal |
| 4 | 352.040 | -41.41 | -56.55 | -13.00 | -28.41 | 15.14 | Peak | Horizontal |
| 5 | 422.850 | -44.67 | -61.30 | -13.00 | -31.67 | 16.63 | Peak | Horizontal |
| 6 | 547.010 | -42.37 | -61.22 | -13.00 | -29.37 | 18.85 | Peak | Horizontal |

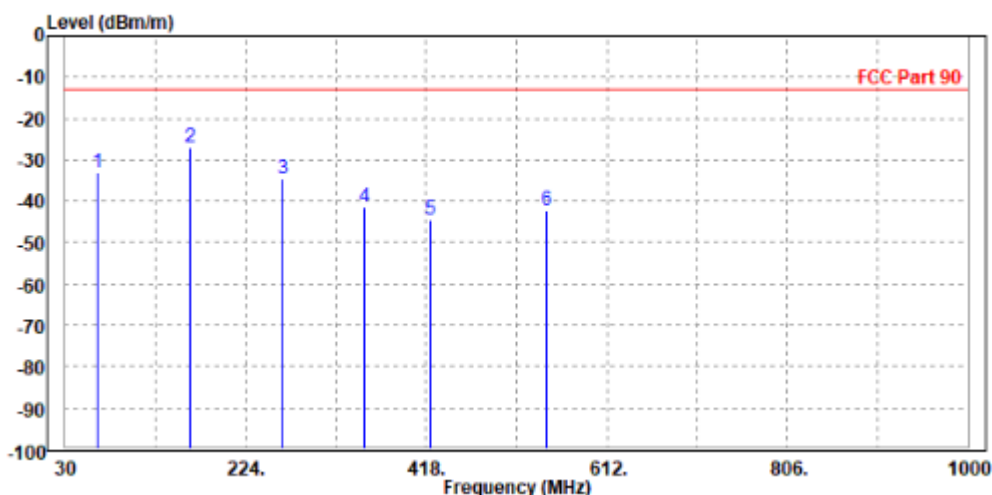

C



Test Report No.: W7L-220503W001RF07

| | | | |
|--|------------------|------------------------|---------------|
| MODE | TX channel 23330 | FREQUENCY RANGE | Below 1000MHz |
| ENVIRONMENTAL CONDITIONS | 23deg. C, 70%RH | INPUT POWER | AC120V/60Hz |
| TESTED BY | Jace HU | | |
| ANTENNA POLARITY & TEST DISTANCE: VERTICAL AT 3 M | | | |

| | Freq | Level | Read Level | Limit Line | Over Limit | Factor | Remark | Pol/Phase |
|------|---------|--------|------------|------------|------------|--------|--------|-----------|
| | MHz | dBm/m | dBm | dBm/m | dB | dB/m | | |
| 1 | 33.880 | -29.85 | -48.21 | -13.00 | -16.85 | 18.36 | Peak | Vertical |
| 2 | 70.740 | -30.38 | -38.44 | -13.00 | -17.38 | 8.06 | Peak | Vertical |
| 3 PP | 159.980 | -29.19 | -40.09 | -13.00 | -16.19 | 10.90 | Peak | Vertical |
| 4 | 264.740 | -39.47 | -52.48 | -13.00 | -26.47 | 13.01 | Peak | Vertical |
| 5 | 352.040 | -43.97 | -59.17 | -13.00 | -30.97 | 15.20 | Peak | Vertical |
| 6 | 547.010 | -43.06 | -61.60 | -13.00 | -30.06 | 18.54 | Peak | Vertical |

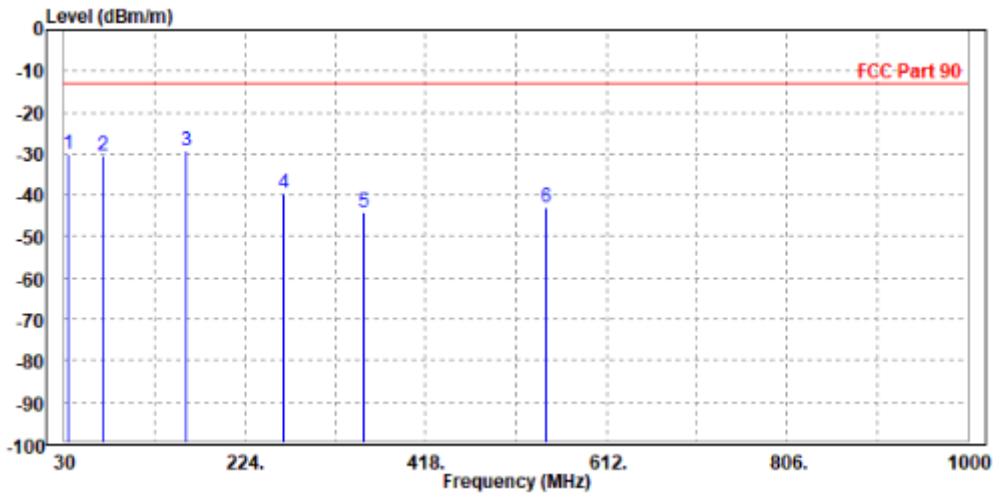



Test Report No.: W7L-220503W001RF07

ABOVE 1GHz

Note: For higher frequency, the emission is too low to be detected.

LTE B14

CHANNEL BANDWIDTH: 5MHz / QPSK

CH23305

| | | | |
|--|------------------|------------------------|---------------|
| MODE | TX channel 23305 | FREQUENCY RANGE | Above 1000MHz |
| ENVIRONMENTAL CONDITIONS | 23deg. C, 70%RH | INPUT POWER | AC120V/60Hz |
| TESTED BY | Star Le | | |
| ANTENNA POLARITY & TEST DISTANCE: HORIZONTAL AT 3 M | | | |

| | Freq | Level | Read Level | Limit Line | Over Limit | Factor | Remark | Pol/Phase |
|---|-------------|--------|------------|------------|------------|--------|--------|------------|
| | MHz | dBm/m | dBm | dBm/m | dB | dB/m | | |
| 1 | PP 1578.000 | -39.26 | -41.66 | -13.00 | -26.26 | 2.40 | Peak | Horizontal |
| 2 | 2371.500 | -45.63 | -53.55 | -13.00 | -32.63 | 7.92 | Peak | Horizontal |

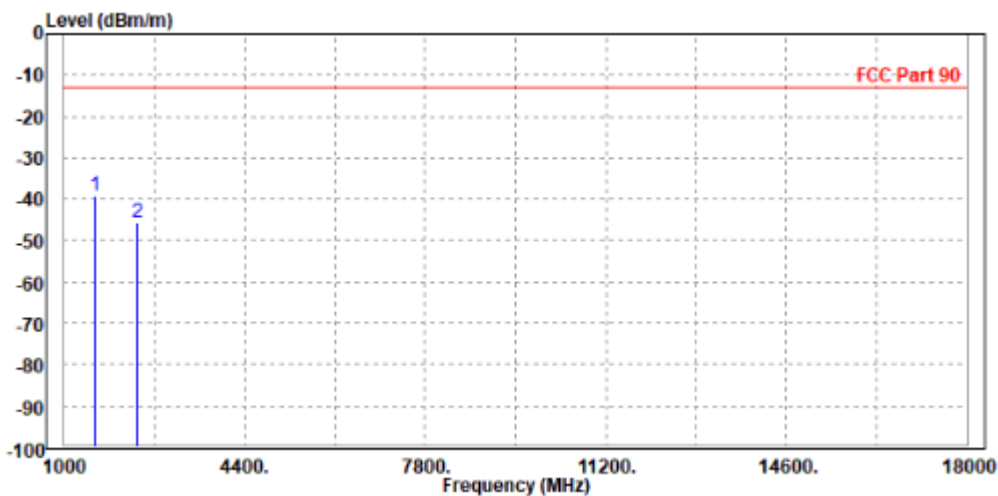



Test Report No.: W7L-220503W001RF07

| | | | |
|--|------------------|------------------------|---------------|
| MODE | TX channel 23305 | FREQUENCY RANGE | Above 1000MHz |
| ENVIRONMENTAL CONDITIONS | 23deg. C, 70%RH | INPUT POWER | AC120V/60Hz |
| TESTED BY | Star Le | | |
| ANTENNA POLARITY & TEST DISTANCE: VERTICAL AT 3 M | | | |

| | Freq | Level | Read Level | Limit Line | Over Limit | Factor | Remark | Pol/Phase |
|---|-------------|--------|------------|------------|------------|--------|--------|-----------|
| | MHz | dBm/m | dBm | dBm/m | dB | dB/m | | |
| 1 | PP 1578.000 | -45.01 | -47.76 | -13.00 | -32.01 | 2.75 | Peak | Vertical |
| 2 | 2371.500 | -48.92 | -55.86 | -13.00 | -35.92 | 6.94 | Peak | Vertical |

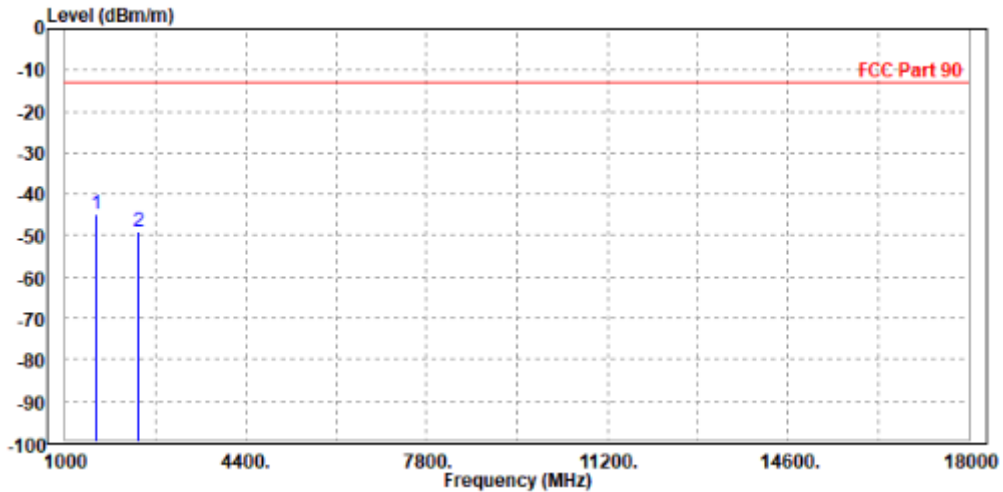



Test Report No.: W7L-220503W001RF07

CH23330

| | | | |
|--|------------------|------------------------|---------------|
| MODE | TX channel 23330 | FREQUENCY RANGE | Above 1000MHz |
| ENVIRONMENTAL CONDITIONS | 23deg. C, 70%RH | INPUT POWER | AC120V/60Hz |
| TESTED BY | Star Le | | |
| ANTENNA POLARITY & TEST DISTANCE: HORIZONTAL AT 3 M | | | |

| | Freq | Level | Read Level | Limit Line | Over Limit | Factor | Remark | Pol/Phase |
|---|-------------|--------|------------|------------|------------|--------|--------|------------|
| | MHz | dBm/m | dBm | dBm/m | dB | dB/m | | |
| 1 | PP 1578.000 | -44.48 | -46.88 | -13.00 | -31.48 | 2.40 | Peak | Horizontal |
| 2 | 2379.000 | -49.22 | -57.15 | -13.00 | -36.22 | 7.93 | Peak | Horizontal |

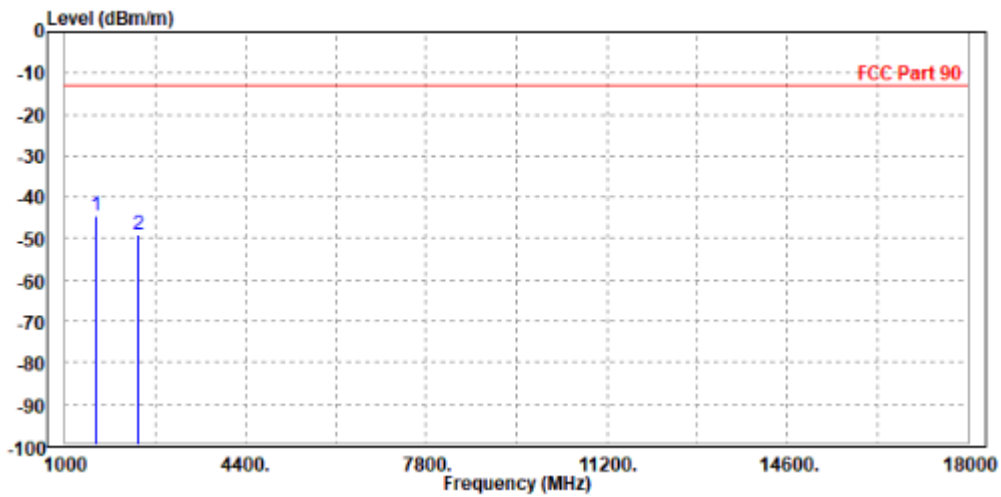



Test Report No.: W7L-220503W001RF07

| | | | |
|--|------------------|------------------------|---------------|
| MODE | TX channel 23330 | FREQUENCY RANGE | Above 1000MHz |
| ENVIRONMENTAL CONDITIONS | 23deg. C, 70%RH | INPUT POWER | AC120V/60Hz |
| TESTED BY | Star Le | | |
| ANTENNA POLARITY & TEST DISTANCE: VERTICAL AT 3 M | | | |

| | Freq | Level | Read Level | Limit Line | Over Limit | Factor | Remark | Pol/Phase |
|---|-------------|--------|------------|------------|------------|--------|--------|-----------|
| | MHz | dBm/m | dBm | dBm/m | dB | dB/m | | |
| 1 | 1578.000 | -54.22 | -56.97 | -13.00 | -41.22 | 2.75 | Peak | Vertical |
| 2 | PP 2379.000 | -49.58 | -56.52 | -13.00 | -36.58 | 6.94 | Peak | Vertical |

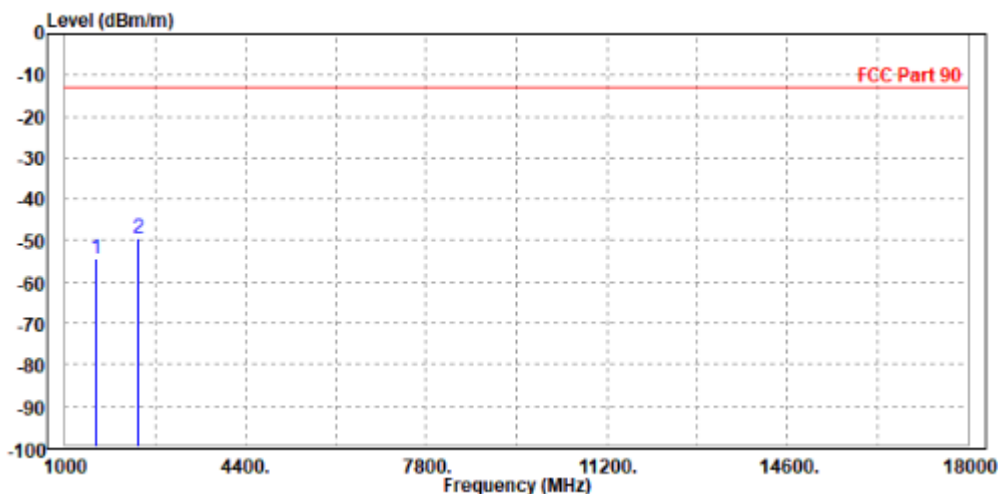



Test Report No.: W7L-220503W001RF07

CH23355

| | | | |
|--|------------------|-----------------|---------------|
| MODE | TX channel 23355 | FREQUENCY RANGE | Above 1000MHz |
| ENVIRONMENTAL CONDITIONS | 23deg. C, 70%RH | INPUT POWER | AC120V/60Hz |
| TESTED BY | Star Le | | |
| ANTENNA POLARITY & TEST DISTANCE: HORIZONTAL AT 3 M | | | |

| | Freq | Level | Read Level | Limit Line | Over Limit | Factor | Remark | Pol/Phase |
|------|----------|--------|------------|------------|------------|--------|--------|------------|
| | MHz | dBm/m | dBm | dBm/m | dB | dB/m | | |
| 1 | 1595.000 | -35.58 | -38.18 | -13.00 | -22.58 | 2.60 | Peak | Horizontal |
| 2 PP | 2386.500 | -19.94 | -27.88 | -13.00 | -6.94 | 7.94 | Peak | Horizontal |

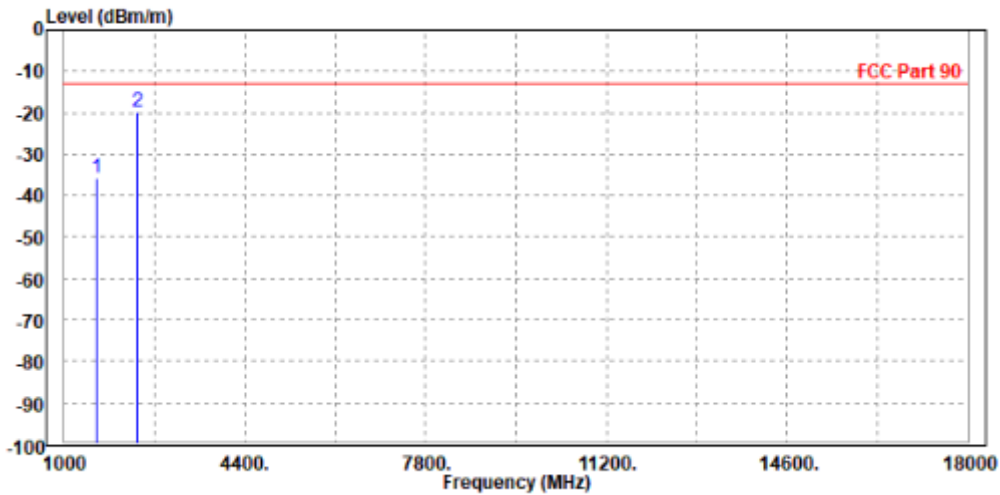



Test Report No.: W7L-220503W001RF07

| | | | |
|--|------------------|------------------------|---------------|
| MODE | TX channel 23355 | FREQUENCY RANGE | Above 1000MHz |
| ENVIRONMENTAL CONDITIONS | 23deg. C, 70%RH | INPUT POWER | AC120V/60Hz |
| TESTED BY | Star Le | | |
| ANTENNA POLARITY & TEST DISTANCE: VERTICAL AT 3 M | | | |

| | Freq | Level | Read Level | Limit Line | Over Limit | Factor | Remark | Pol/Phase |
|---|-------------|--------|------------|------------|------------|--------|--------|-----------|
| | MHz | dBm/m | dBm | dBm/m | dB | dB/m | | |
| 1 | 1591.000 | -43.19 | -46.06 | -13.00 | -30.19 | 2.87 | Peak | Vertical |
| 2 | PP 2386.500 | -27.28 | -34.23 | -13.00 | -14.28 | 6.95 | Peak | Vertical |

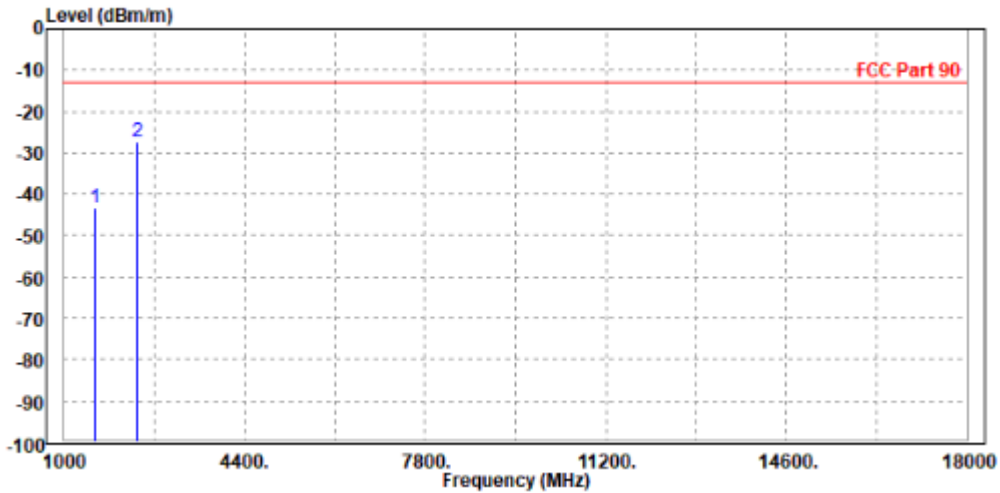



BUREAU VERITAS

Test Report No.: W7L-220503W001RF07

CHANNEL BANDWIDTH: 10MHz / QPSK

CH23330

| | | | |
|--|------------------|-----------------|---------------|
| MODE | TX channel 23330 | FREQUENCY RANGE | Above 1000MHz |
| ENVIRONMENTAL CONDITIONS | 23deg. C, 70%RH | INPUT POWER | AC120V/60Hz |
| TESTED BY | Star Le | | |
| ANTENNA POLARITY & TEST DISTANCE: HORIZONTAL AT 3 M | | | |

| | Freq | Level | Read Level | Limit Line | Over Limit | Factor | Remark | Pol/Phase |
|---|-------------|--------|------------|------------|------------|--------|--------|------------|
| | MHz | dBm/m | dBm | dBm/m | dB | dB/m | | |
| 1 | PP 1578.000 | -31.81 | -34.21 | -13.00 | -18.81 | 2.40 | Peak | Horizontal |
| 2 | 2379.000 | -49.69 | -57.62 | -13.00 | -36.69 | 7.93 | Peak | Horizontal |

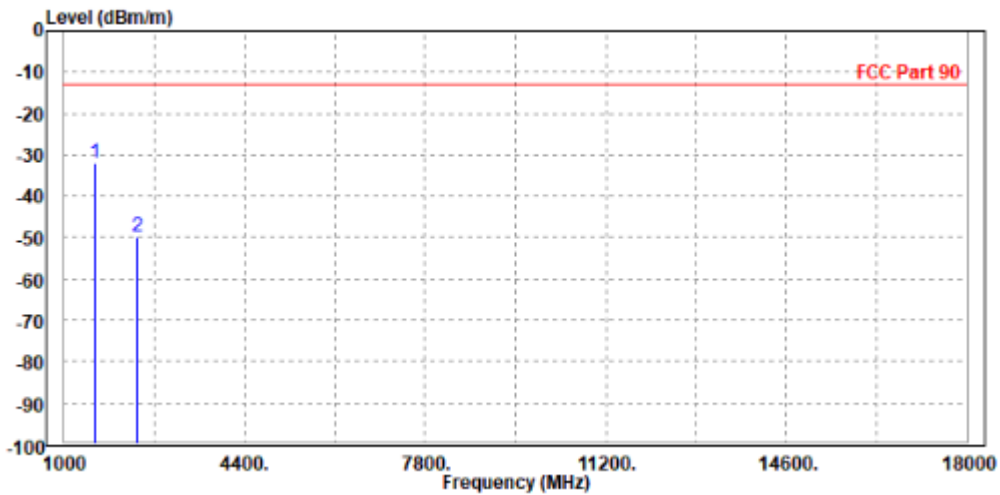



**BUREAU
VERITAS**

Test Report No.: W7L-220503W001RF07

| | | | |
|--|------------------|------------------------|---------------|
| MODE | TX channel 23330 | FREQUENCY RANGE | Above 1000MHz |
| ENVIRONMENTAL CONDITIONS | 23deg. C, 70%RH | INPUT POWER | AC120V/60Hz |
| TESTED BY | Star Le | | |
| ANTENNA POLARITY & TEST DISTANCE: VERTICAL AT 3 M | | | |

| | Freq | Level | Read Level | Limit Line | Over Limit | Factor | Remark | Pol/Phase |
|---|-------------|--------|------------|------------|------------|--------|--------|-----------|
| | MHz | dBm/m | dBm | dBm/m | dB | dB/m | | |
| 1 | PP 1578.000 | -38.92 | -41.67 | -13.00 | -25.92 | 2.75 | Peak | Vertical |
| 2 | 2379.000 | -49.83 | -56.77 | -13.00 | -36.83 | 6.94 | Peak | Vertical |

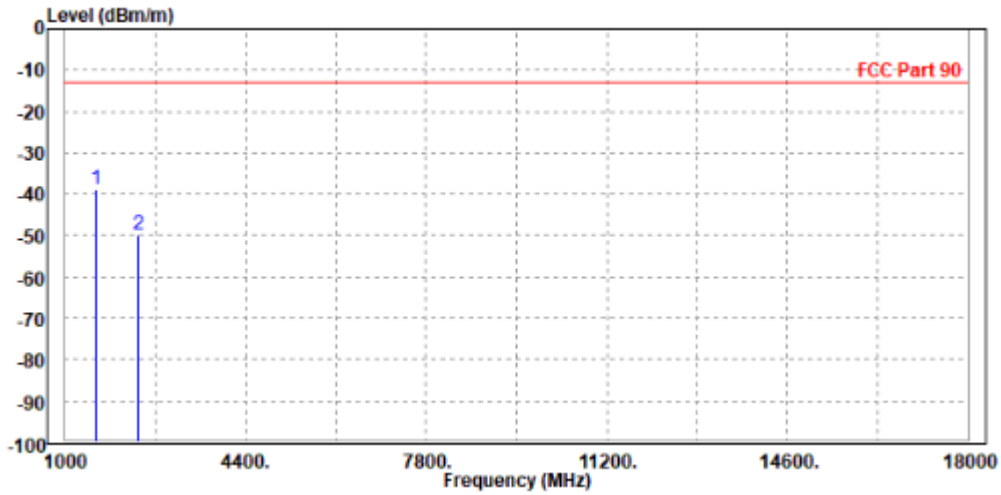

3.7 PEAK TO AVERAGE RATIO

3.7.1 LIMITS OF PEAK TO AVERAGE RATIO MEASUREMENT

In measuring transmissions in this band using an average power technique, the peak to-average ratio (PAR) of the transmission may not exceed 13 dB

3.7.2 TEST SETUP

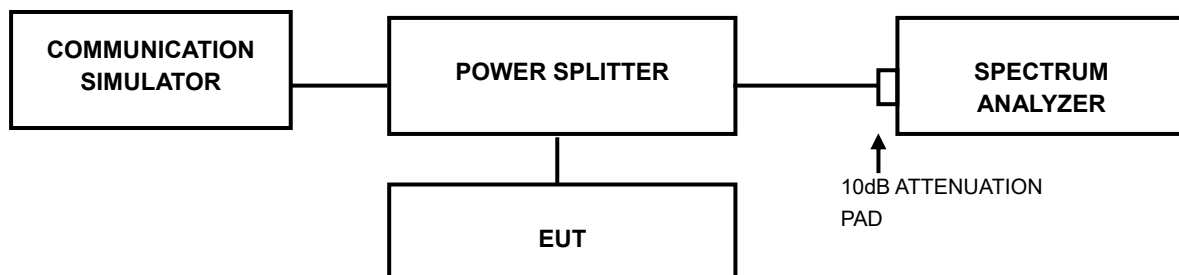

3.7.3 TEST PROCEDURES

1. Set resolution/measurement bandwidth \geq signal's occupied bandwidth;
2. Set the number of counts to a value that stabilizes the measured CCDF curve;
3. Record the maximum PAPR level associated with a probability of 0.1%.



Test Report No.: W7L-220503W001RF07

3.7.4 TEST RESULTS

Please Refer to Appendix A Of this test report.



Test Report No.: W7L-220503W001RF07

4 INFORMATION ON THE TESTING LABORATORIES

We, BV 7LAYERS COMMUNICATIONS TECHNOLOGY (SHENZHEN) CO. LTD., were founded in 2015 to provide our best service in EMC, Radio, Telecom and Safety consultation. Our laboratories are accredited and approved according to ISO/IEC 17025.

If you have any comments, please feel free to contact us at the following:

Shenzhen EMC/RF Lab:

Tel: +86-755-88696566

Fax: +86-755-88696577

Email: customerservice.sw@bureauveritas.com

Web Site: www.adt.com.tw

The address and road map of all our labs can be found in our web site also.



Test Report No.: W7L-220503W001RF07

5 MODIFICATIONS RECORDERS FOR ENGINEERING CHANGES TO THE EUT BY THE LAB

No modifications were made to the EUT by the lab during the test.



**BUREAU
VERITAS**

Test Report No.: W7L-220503W001RF07

APPENDIX A

LTE Band14

Frequency Stability

B14_5MHz

Test Result

| Band: 14 / Bandwidth: 5MHz | | | | | | | | | |
|----------------------------|-----------------|---------------|--------|-------------|---------------|------------------|-----------------------|-------------|---------|
| Modulation | Frequency (MHz) | RB Allocation | | Temp. (°C) | Voltage (VDC) | Freq. Error (Hz) | Freq. vs. Rated (ppm) | | Verdict |
| | | Size | Offset | | | | Result | Limit | |
| QPSK | 790.5 | 25 | 0 | 20 | 3.27 | -8.17 | -0.01 | -2.5 to 2.5 | Pass |
| | | | | | 3.85 | -9.21 | -0.01 | -2.5 to 2.5 | Pass |
| | | | | | 4.43 | -5.95 | -0.01 | -2.5 to 2.5 | Pass |
| | | | | -10 | 3.85 | -5.81 | -0.01 | -2.5 to 2.5 | Pass |
| | | | | 0 | 3.85 | -5.51 | -0.01 | -2.5 to 2.5 | Pass |
| | | | | 10 | 3.85 | -4.55 | -0.01 | -2.5 to 2.5 | Pass |
| | | | | 30 | 3.85 | -7.00 | -0.01 | -2.5 to 2.5 | Pass |
| | | | | 40 | 3.85 | -6.68 | -0.01 | -2.5 to 2.5 | Pass |
| | 50 | 3.85 | -6.94 | -0.01 | -2.5 to 2.5 | Pass | | | |
| | 793 | 25 | 0 | 20 | 3.27 | -4.86 | -0.01 | -2.5 to 2.5 | Pass |
| | | | | | 3.85 | -10.39 | -0.01 | -2.5 to 2.5 | Pass |
| | | | | | 4.43 | -8.00 | -0.01 | -2.5 to 2.5 | Pass |
| | | | | -10 | 3.85 | -5.46 | -0.01 | -2.5 to 2.5 | Pass |
| | | | | 0 | 3.85 | -4.22 | -0.01 | -2.5 to 2.5 | Pass |
| | | | | 10 | 3.85 | -3.45 | -0.00 | -2.5 to 2.5 | Pass |
| | | | | 30 | 3.85 | -2.69 | -0.00 | -2.5 to 2.5 | Pass |
| | | | | 40 | 3.85 | -4.39 | -0.01 | -2.5 to 2.5 | Pass |
| | 50 | 3.85 | -4.92 | -0.01 | -2.5 to 2.5 | Pass | | | |
| | 795.5 | 25 | 0 | 20 | 3.27 | -1.86 | -0.00 | -2.5 to 2.5 | Pass |
| | | | | | 3.85 | -6.39 | -0.01 | -2.5 to 2.5 | Pass |
| | | | | | 4.43 | -9.96 | -0.01 | -2.5 to 2.5 | Pass |
| | | | | -10 | 3.85 | -5.04 | -0.01 | -2.5 to 2.5 | Pass |
| | | | | 0 | 3.85 | -4.89 | -0.01 | -2.5 to 2.5 | Pass |
| | | | | 10 | 3.85 | -4.76 | -0.01 | -2.5 to 2.5 | Pass |
| 30 | | | | 3.85 | -3.03 | -0.00 | -2.5 to 2.5 | Pass | |
| 40 | | | | 3.85 | -3.12 | -0.00 | -2.5 to 2.5 | Pass | |
| 50 | 3.85 | -4.88 | -0.01 | -2.5 to 2.5 | Pass | | | | |
| 16QAM | 790.5 | 25 | 0 | 20 | 3.27 | -4.93 | -0.01 | -2.5 to 2.5 | Pass |
| | | | | | 3.85 | -5.78 | -0.01 | -2.5 to 2.5 | Pass |
| | | | | | 4.43 | -7.14 | -0.01 | -2.5 to 2.5 | Pass |
| | | | | -10 | 3.85 | -7.40 | -0.01 | -2.5 to 2.5 | Pass |
| | | | | 0 | 3.85 | -7.62 | -0.01 | -2.5 to 2.5 | Pass |
| | | | | 10 | 3.85 | -5.78 | -0.01 | -2.5 to 2.5 | Pass |
| | | | | 30 | 3.85 | -3.06 | -0.00 | -2.5 to 2.5 | Pass |
| | | | | 40 | 3.85 | -5.19 | -0.01 | -2.5 to 2.5 | Pass |
| | 50 | 3.85 | -3.19 | -0.00 | -2.5 to 2.5 | Pass | | | |
| | 793 | 25 | 0 | 20 | 3.27 | -5.54 | -0.01 | -2.5 to 2.5 | Pass |
| | | | | | 3.85 | -3.71 | -0.00 | -2.5 to 2.5 | Pass |



**BUREAU
VERITAS**

Test Report No.: W7L-220503W001RF07

| | | | | | | | | | | | | | | | | | | |
|-------|-------|------|-------|-------|-------------|-------|-------|-------------|-------------|-------|-------------|-------------|------|-------|-------|-------------|-------------|------|
| | | | | | 4.43 | -8.07 | -0.01 | -2.5 to 2.5 | Pass | | | | | | | | | |
| | | | | -10 | 3.85 | -4.03 | -0.01 | -2.5 to 2.5 | Pass | | | | | | | | | |
| | | | | 0 | 3.85 | -3.16 | -0.00 | -2.5 to 2.5 | Pass | | | | | | | | | |
| | | | | 10 | 3.85 | -4.39 | -0.01 | -2.5 to 2.5 | Pass | | | | | | | | | |
| | | | | 30 | 3.85 | -4.25 | -0.01 | -2.5 to 2.5 | Pass | | | | | | | | | |
| | | | | 40 | 3.85 | -9.46 | -0.01 | -2.5 to 2.5 | Pass | | | | | | | | | |
| | 50 | 3.85 | -2.69 | -0.00 | -2.5 to 2.5 | Pass | | | | | | | | | | | | |
| | 795.5 | 25 | 0 | 20 | | 3.27 | -5.15 | -0.01 | -2.5 to 2.5 | Pass | | | | | | | | |
| | | | | | | 3.85 | -6.28 | -0.01 | -2.5 to 2.5 | Pass | | | | | | | | |
| | | | | | | 4.43 | -7.62 | -0.01 | -2.5 to 2.5 | Pass | | | | | | | | |
| | | | | | | | | -10 | 3.85 | -6.25 | -0.01 | -2.5 to 2.5 | Pass | | | | | |
| | | | | | | | | 0 | 3.85 | -1.93 | -0.00 | -2.5 to 2.5 | Pass | | | | | |
| | | | | | | | | 10 | 3.85 | -4.22 | -0.01 | -2.5 to 2.5 | Pass | | | | | |
| | | | | | | | | 30 | 3.85 | -4.91 | -0.01 | -2.5 to 2.5 | Pass | | | | | |
| | | | | | | | | 40 | 3.85 | -3.83 | -0.00 | -2.5 to 2.5 | Pass | | | | | |
| | | | | | | | | 50 | 3.85 | -3.15 | -0.00 | -2.5 to 2.5 | Pass | | | | | |
| | | | | | | | | 64QAM | 790.5 | 25 | 0 | 20 | | 3.27 | -5.74 | -0.01 | -2.5 to 2.5 | Pass |
| | | | | | | | | | | | | | | 3.85 | -8.21 | -0.01 | -2.5 to 2.5 | Pass |
| | | | | | | | | | | | | | 4.43 | -6.05 | -0.01 | -2.5 to 2.5 | Pass | |
| | | | | -10 | 3.85 | -6.77 | -0.01 | | | | | -2.5 to 2.5 | Pass | | | | | |
| | | | | 0 | 3.85 | -5.49 | -0.01 | | | | | -2.5 to 2.5 | Pass | | | | | |
| | | | | 10 | 3.85 | -5.31 | -0.01 | | | | | -2.5 to 2.5 | Pass | | | | | |
| | | | | 30 | 3.85 | -1.56 | -0.00 | | | | | -2.5 to 2.5 | Pass | | | | | |
| | | | | 40 | 3.85 | -5.24 | -0.01 | | | | | -2.5 to 2.5 | Pass | | | | | |
| | | | | 50 | 3.85 | -7.24 | -0.01 | | | | | -2.5 to 2.5 | Pass | | | | | |
| 793 | 25 | 0 | 20 | | 3.27 | -6.01 | -0.01 | | -2.5 to 2.5 | Pass | | | | | | | | |
| | | | | | 3.85 | -4.35 | -0.01 | | -2.5 to 2.5 | Pass | | | | | | | | |
| | | | | | 4.43 | -5.19 | -0.01 | | -2.5 to 2.5 | Pass | | | | | | | | |
| | | | | | | | -10 | | 3.85 | -6.47 | -0.01 | -2.5 to 2.5 | Pass | | | | | |
| | | | | | | | 0 | | 3.85 | -6.92 | -0.01 | -2.5 to 2.5 | Pass | | | | | |
| | | | | | | | 10 | | 3.85 | -8.15 | -0.01 | -2.5 to 2.5 | Pass | | | | | |
| | | | | | | | 30 | | 3.85 | -6.39 | -0.01 | -2.5 to 2.5 | Pass | | | | | |
| | | | | | | | 40 | | 3.85 | -1.96 | -0.00 | -2.5 to 2.5 | Pass | | | | | |
| | | | | | | | 50 | | 3.85 | -6.48 | -0.01 | -2.5 to 2.5 | Pass | | | | | |
| 795.5 | 25 | 0 | 20 | | 3.27 | -5.87 | -0.01 | -2.5 to 2.5 | Pass | | | | | | | | | |
| | | | | | 3.85 | -5.46 | -0.01 | -2.5 to 2.5 | Pass | | | | | | | | | |
| | | | | | 4.43 | -6.05 | -0.01 | -2.5 to 2.5 | Pass | | | | | | | | | |
| | | | | | | | -10 | 3.85 | -8.55 | -0.01 | -2.5 to 2.5 | Pass | | | | | | |
| | | | | | | | 0 | 3.85 | -4.08 | -0.01 | -2.5 to 2.5 | Pass | | | | | | |
| | | | | | | | 10 | 3.85 | -4.29 | -0.01 | -2.5 to 2.5 | Pass | | | | | | |
| | | | | | | | 30 | 3.85 | -10.03 | -0.01 | -2.5 to 2.5 | Pass | | | | | | |
| | | | | | | | 40 | 3.85 | -3.50 | -0.00 | -2.5 to 2.5 | Pass | | | | | | |
| | | | | | | | 50 | 3.85 | -3.39 | -0.00 | -2.5 to 2.5 | Pass | | | | | | |

B14_10MHz

Test Result

| Band: 14 / Bandwidth: 10MHz | | | | | | | | | |
|-----------------------------|-----------------|---------------|--------|------------|---------------|------------------|-----------------------|-------------|---------|
| Modulation | Frequency (MHz) | RB Allocation | | Temp. (°C) | Voltage (VDC) | Freq. Error (Hz) | Freq. vs. Rated (ppm) | | Verdict |
| | | Size | Offset | | | | Result | Limit | |
| QPSK | 793 | 50 | 0 | 20 | 3.27 | -9.20 | -0.01 | -2.5 to 2.5 | Pass |



**BUREAU
VERITAS**

Test Report No.: W7L-220503W001RF07

| | | | | | | | | | | | | | |
|-------|-----|----|---|-----|------|-------|-------|-------------|------|--------|-------|-------------|------|
| | | | | | 3.85 | -6.07 | -0.01 | -2.5 to 2.5 | Pass | | | | |
| | | | | | 4.43 | -6.42 | -0.01 | -2.5 to 2.5 | Pass | | | | |
| | | | | -10 | 3.85 | -6.94 | -0.01 | -2.5 to 2.5 | Pass | | | | |
| | | | | 0 | 3.85 | -4.05 | -0.01 | -2.5 to 2.5 | Pass | | | | |
| | | | | 10 | 3.85 | -7.34 | -0.01 | -2.5 to 2.5 | Pass | | | | |
| | | | | 30 | 3.85 | -8.60 | -0.01 | -2.5 to 2.5 | Pass | | | | |
| | | | | 40 | 3.85 | -5.96 | -0.01 | -2.5 to 2.5 | Pass | | | | |
| | | | | 50 | 3.85 | -8.91 | -0.01 | -2.5 to 2.5 | Pass | | | | |
| 16QAM | 793 | 50 | 0 | 20 | 3.27 | -6.35 | -0.01 | -2.5 to 2.5 | Pass | | | | |
| | | | | | 3.85 | -8.27 | -0.01 | -2.5 to 2.5 | Pass | | | | |
| | | | | | 4.43 | -6.91 | -0.01 | -2.5 to 2.5 | Pass | | | | |
| | | | | | | | | -10 | 3.85 | -7.84 | -0.01 | -2.5 to 2.5 | Pass |
| | | | | | | | | 0 | 3.85 | -6.15 | -0.01 | -2.5 to 2.5 | Pass |
| | | | | | | | | 10 | 3.85 | -4.99 | -0.01 | -2.5 to 2.5 | Pass |
| | | | | | | | | 30 | 3.85 | -7.67 | -0.01 | -2.5 to 2.5 | Pass |
| | | | | | | | | 40 | 3.85 | -8.83 | -0.01 | -2.5 to 2.5 | Pass |
| | | | | 50 | 3.85 | -7.51 | -0.01 | -2.5 to 2.5 | Pass | | | | |
| 64QAM | 793 | 50 | 0 | 20 | 3.27 | -5.72 | -0.01 | -2.5 to 2.5 | Pass | | | | |
| | | | | | 3.85 | -7.47 | -0.01 | -2.5 to 2.5 | Pass | | | | |
| | | | | | 4.43 | -4.41 | -0.01 | -2.5 to 2.5 | Pass | | | | |
| | | | | | | | | -10 | 3.85 | -7.77 | -0.01 | -2.5 to 2.5 | Pass |
| | | | | | | | | 0 | 3.85 | -7.94 | -0.01 | -2.5 to 2.5 | Pass |
| | | | | | | | | 10 | 3.85 | -5.14 | -0.01 | -2.5 to 2.5 | Pass |
| | | | | | | | | 30 | 3.85 | -10.11 | -0.01 | -2.5 to 2.5 | Pass |
| | | | | | | | | 40 | 3.85 | -8.67 | -0.01 | -2.5 to 2.5 | Pass |
| | | | | 50 | 3.85 | -9.04 | -0.01 | -2.5 to 2.5 | Pass | | | | |



Test Report No.: W7L-220503W001RF07

99% & 26dB Bandwidth

99%_OBW

Test Result

| Band: 14 / NTNv | | | | | | |
|-----------------|------------|-----------------|---------------|--------|------------------------------|---------|
| Bandwidth (MHz) | Modulation | Frequency (MHz) | RB Allocation | | 99% Occupied Bandwidth (MHz) | Verdict |
| | | | Size | Offset | Result | |
| 5 | QPSK | 790.5 | 25 | 0 | 4.589 | Pass |
| | | 793 | 25 | 0 | 4.574 | Pass |
| | | 795.5 | 25 | 0 | 4.558 | Pass |
| | 16QAM | 790.5 | 25 | 0 | 4.560 | Pass |
| | | 793 | 25 | 0 | 4.589 | Pass |
| | | 795.5 | 25 | 0 | 4.598 | Pass |
| | 64QAM | 790.5 | 25 | 0 | 4.561 | Pass |
| | | 793 | 25 | 0 | 4.583 | Pass |
| | | 795.5 | 25 | 0 | 4.569 | Pass |
| 10 | QPSK | / | / | / | / | Pass |
| | | 793 | 50 | 0 | 9.101 | Pass |
| | | / | / | / | / | Pass |
| | 16QAM | / | / | / | / | Pass |
| | | 793 | 50 | 0 | 9.075 | Pass |
| | | / | / | / | / | Pass |
| | 64QAM | / | / | / | / | Pass |
| | | 793 | 50 | 0 | 9.089 | Pass |
| | | / | / | / | / | Pass |

Test Graph

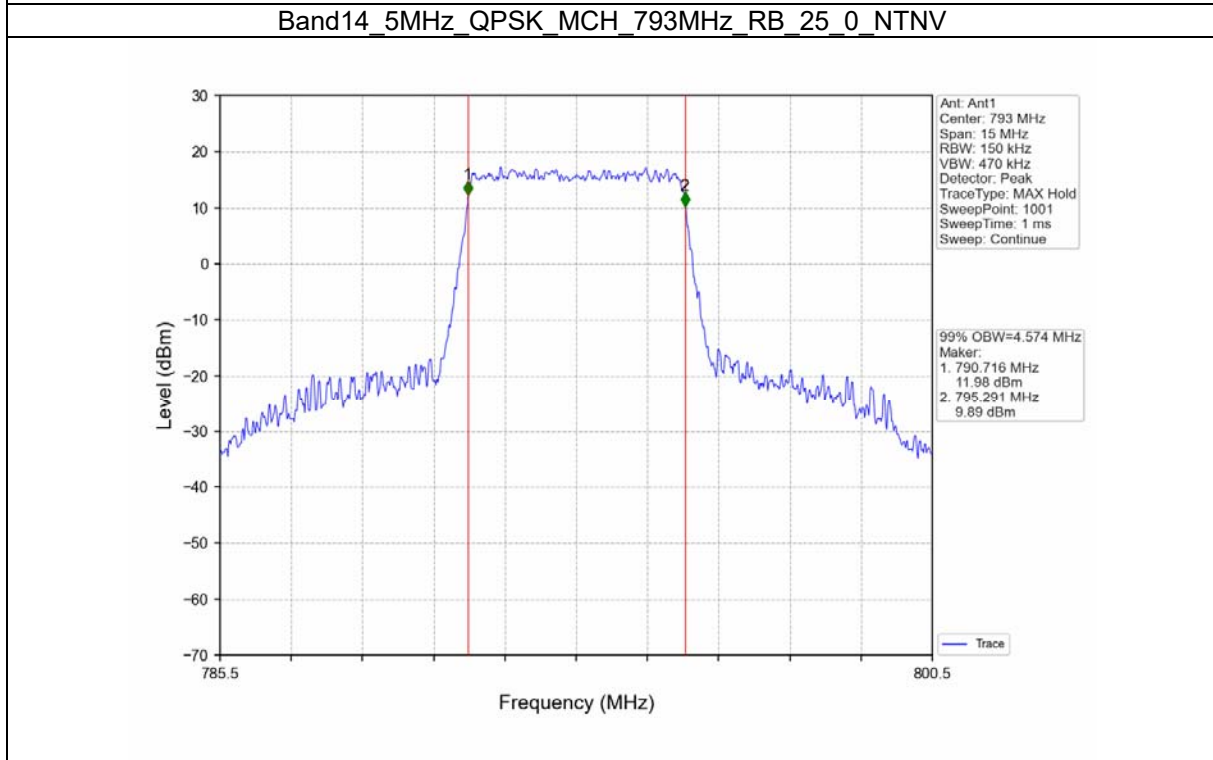
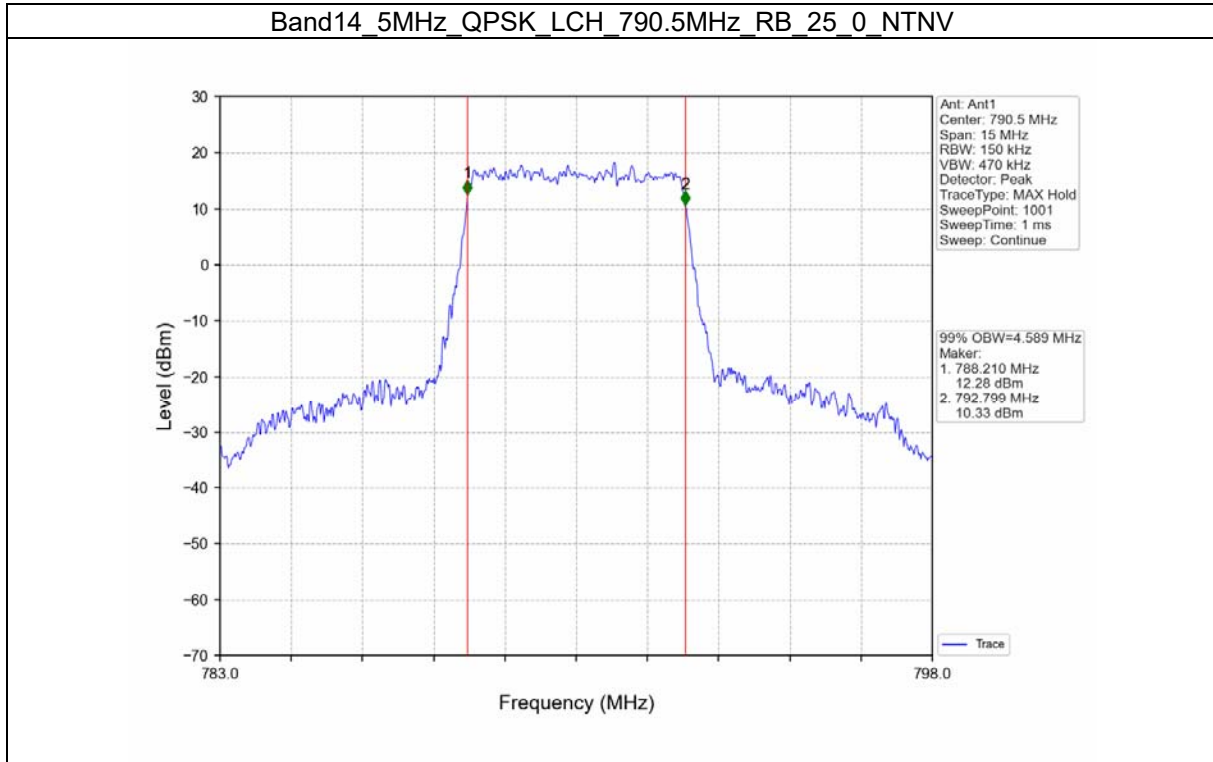

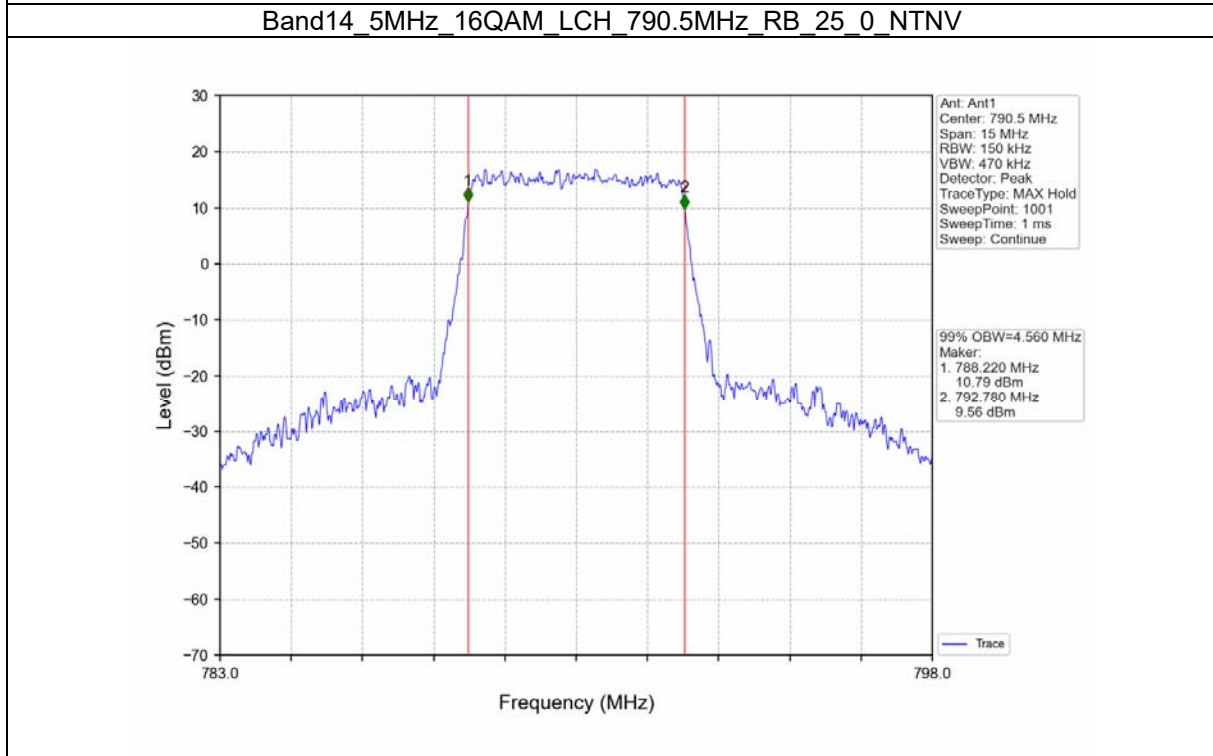
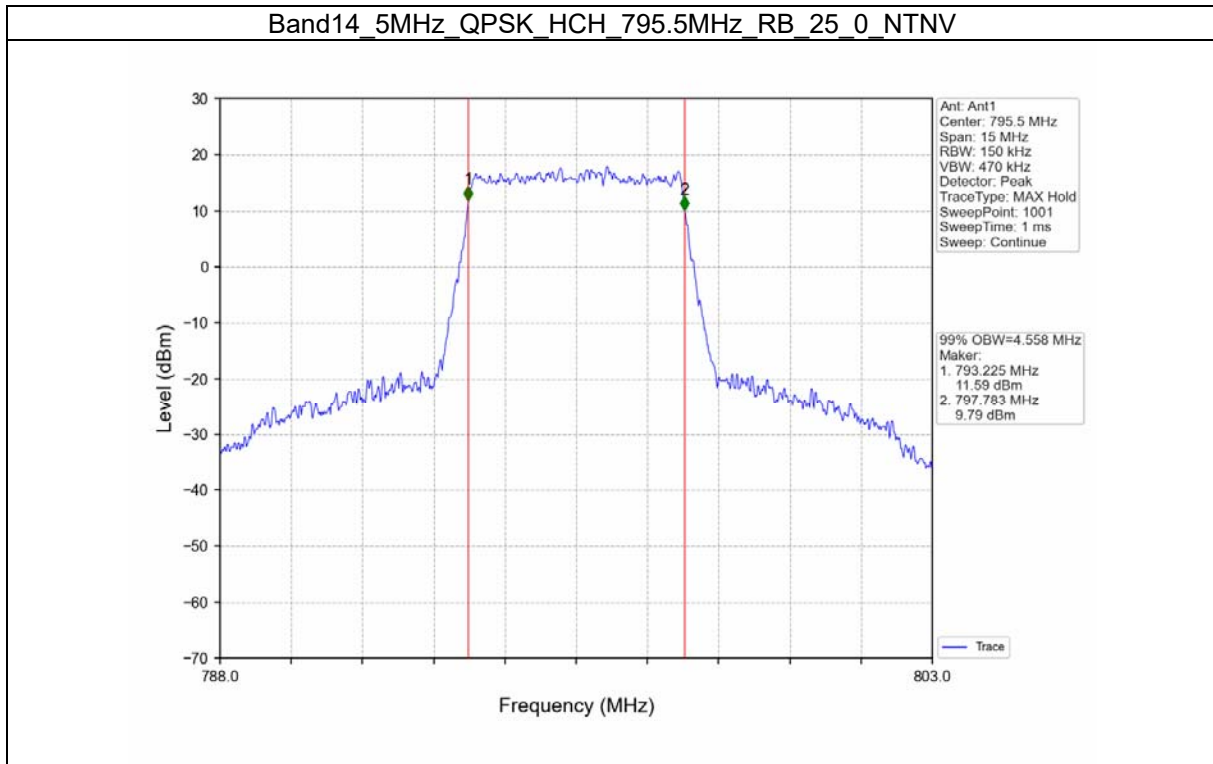

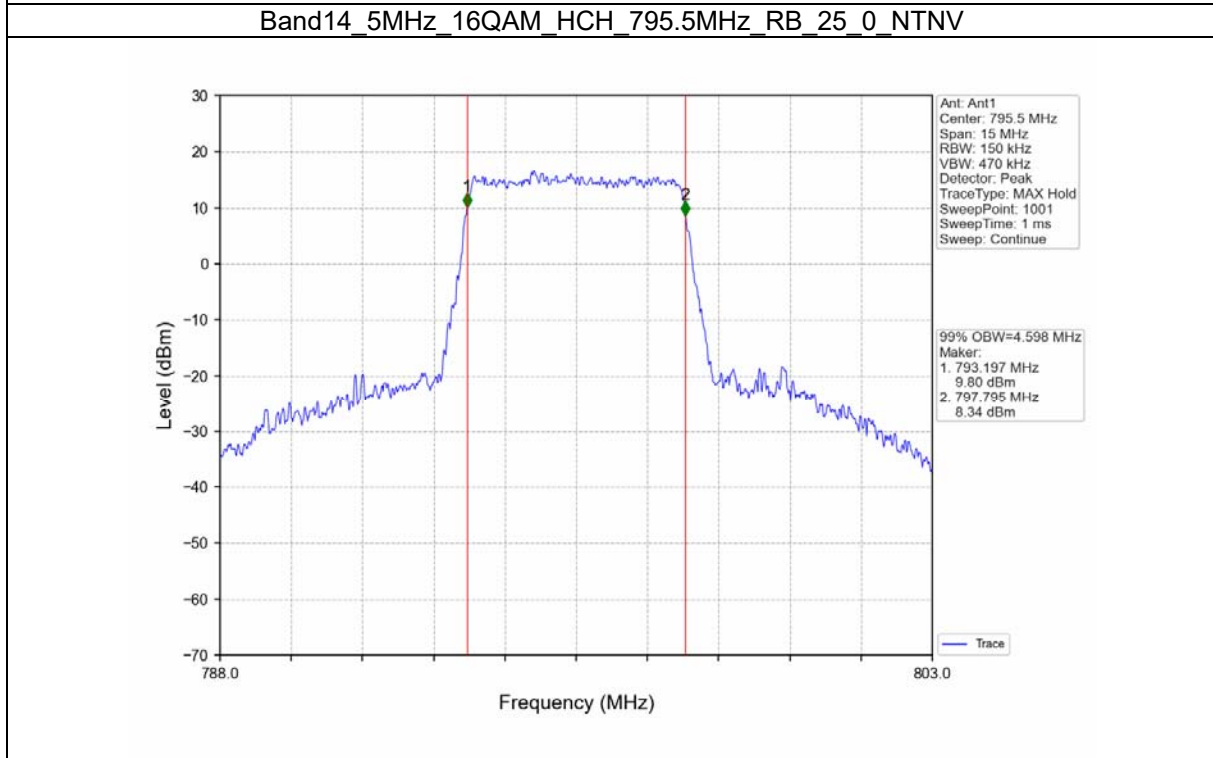
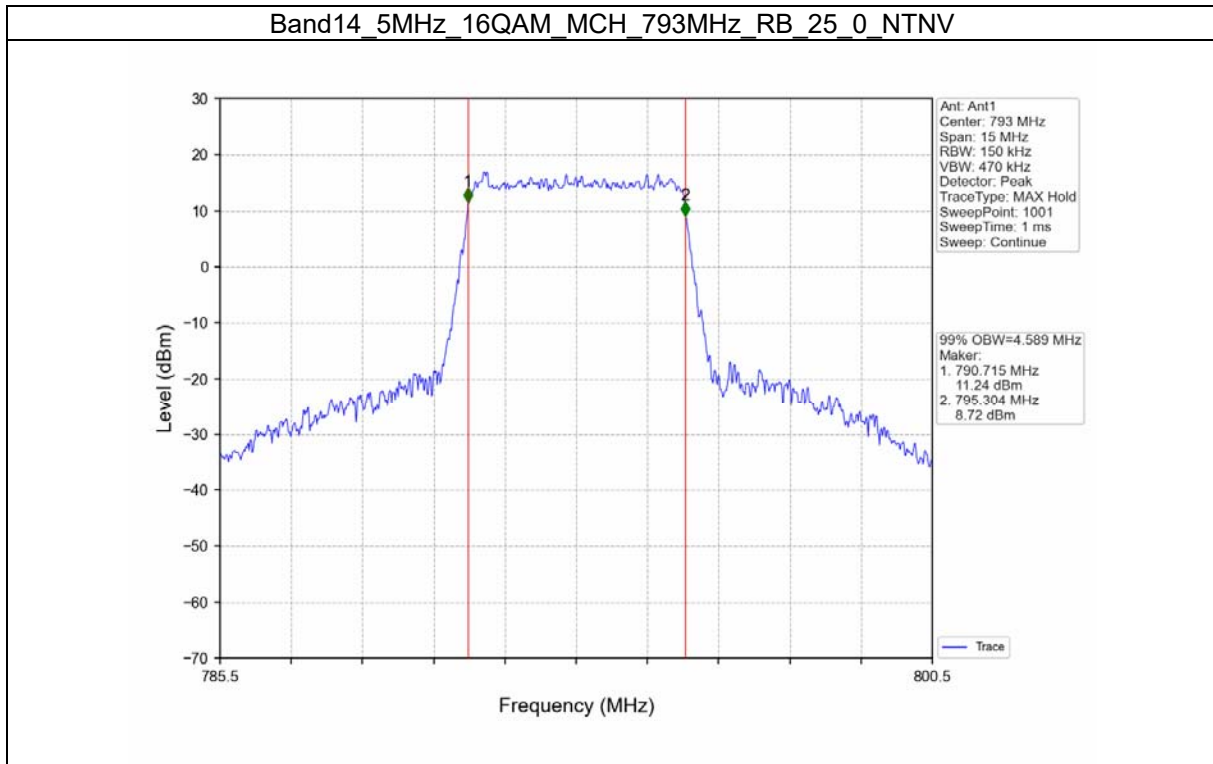

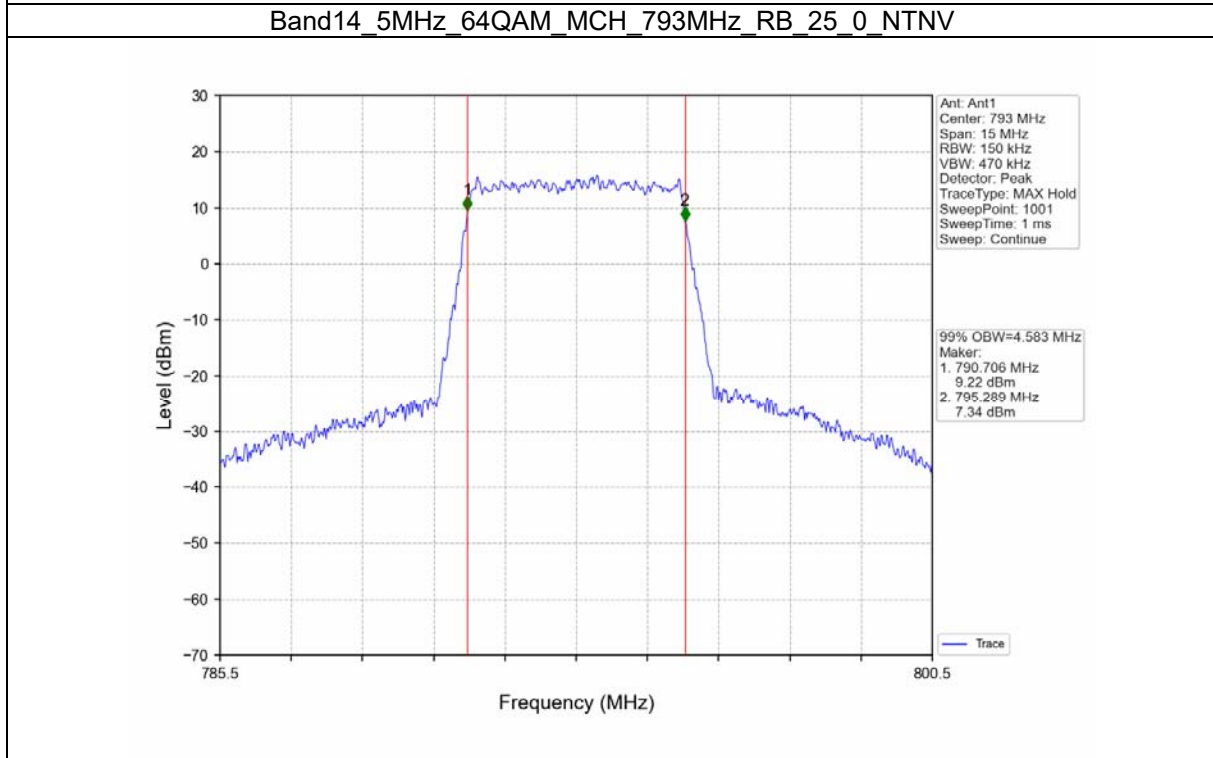
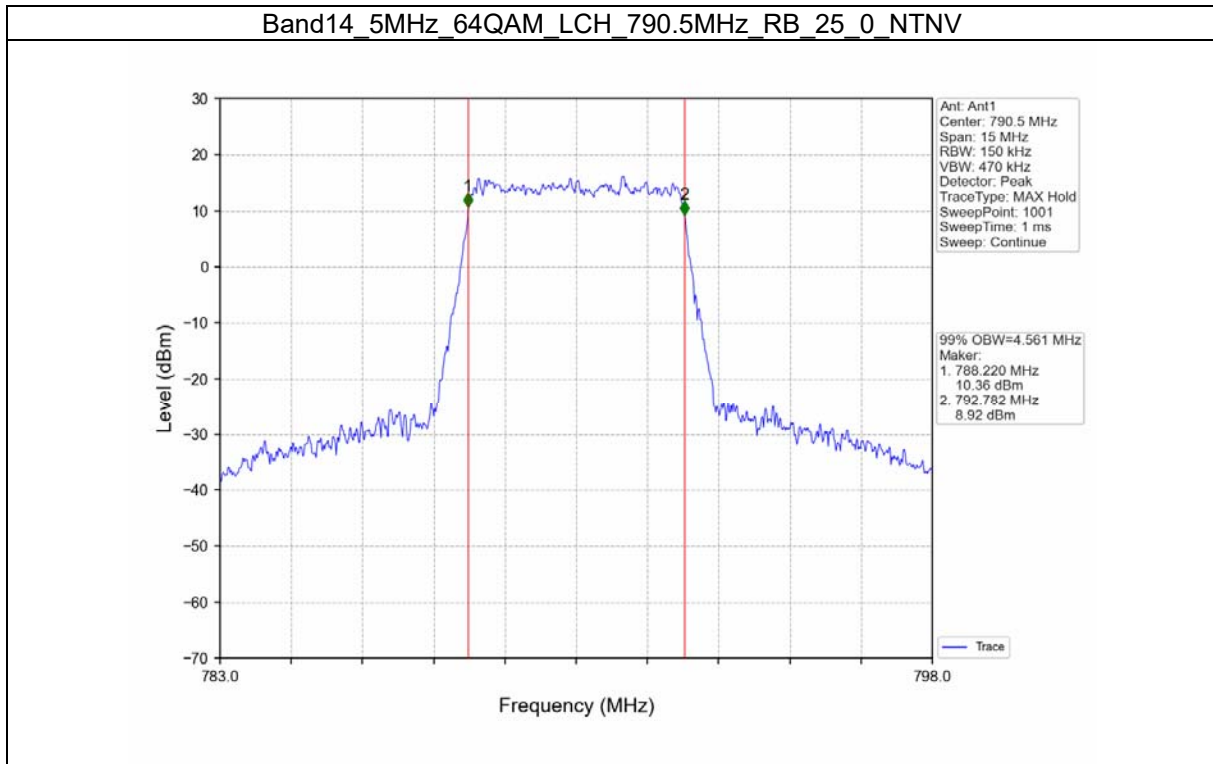

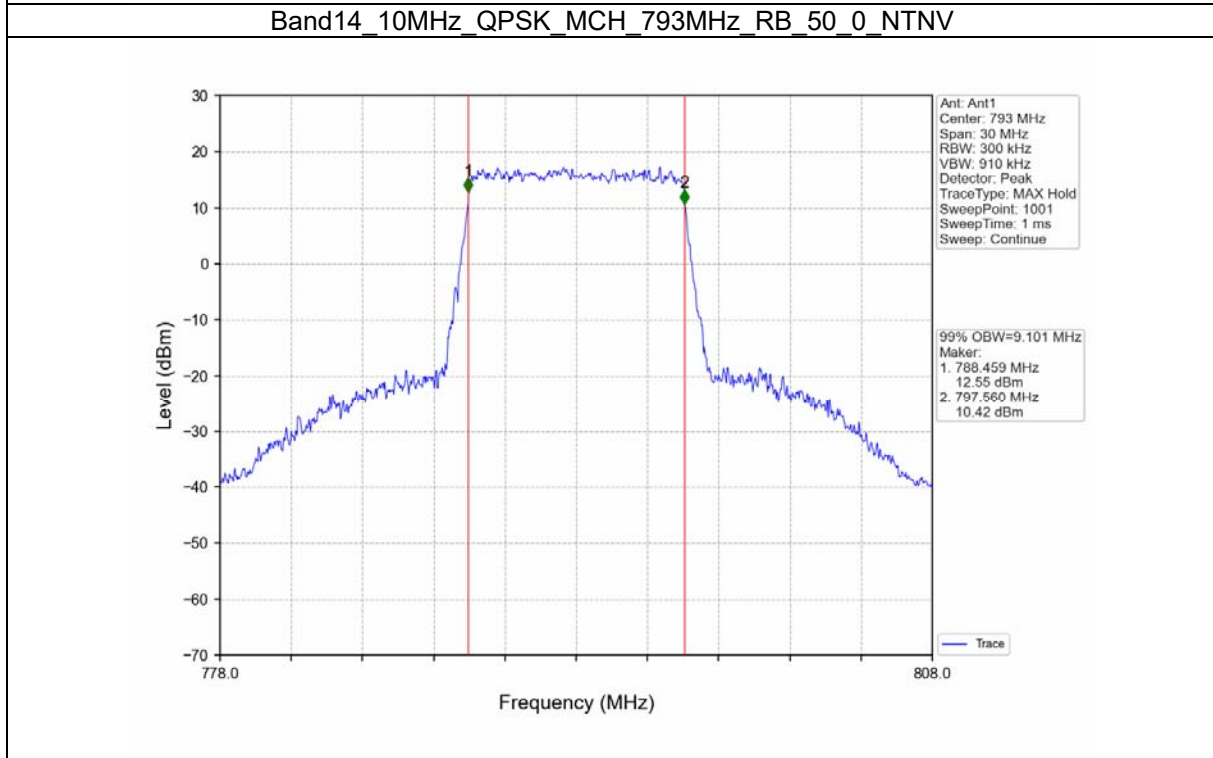
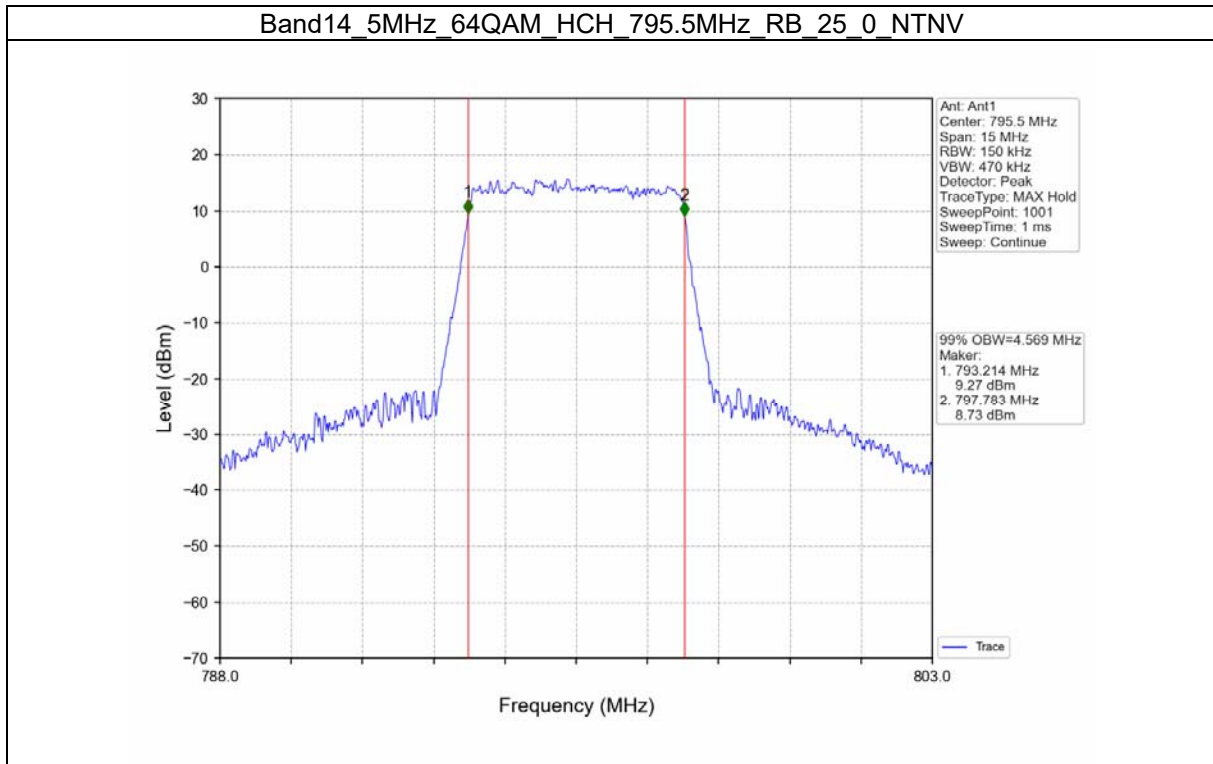

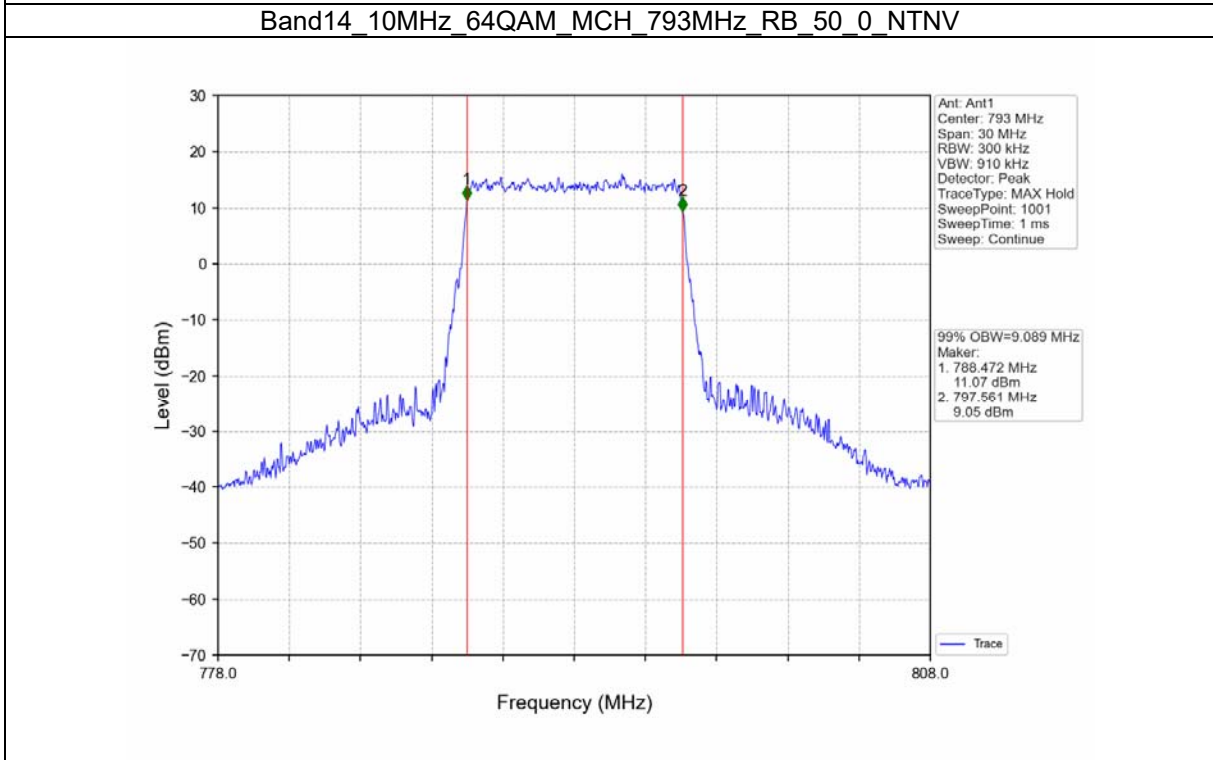
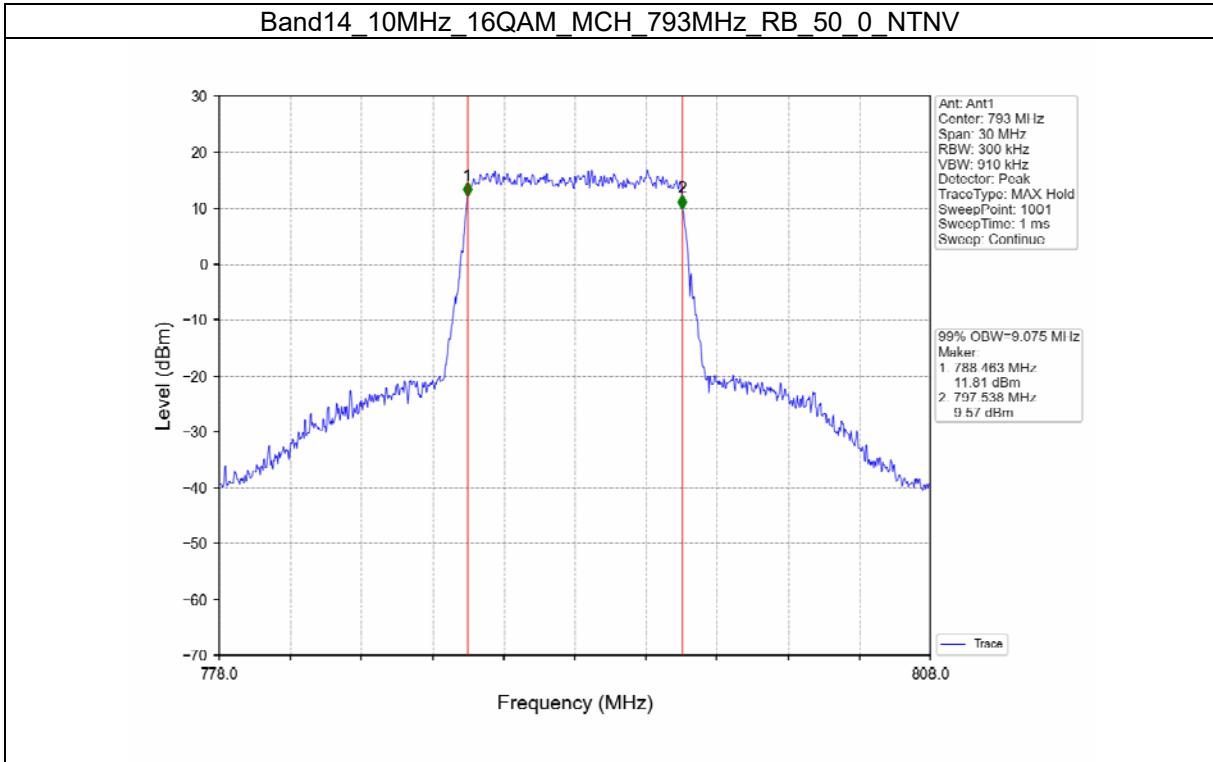



Test Report No.: W7L-220503W001RF07

26DB_BW

Test Result

| Band: 14 / NTNV | | | | | | |
|-----------------|------------|-----------------|---------------|--------|----------------------|---------|
| Bandwidth (MHz) | Modulation | Frequency (MHz) | RB Allocation | | 26dB Bandwidth (MHz) | Verdict |
| | | | Size | Offset | | |
| 5 | QPSK | 790.5 | 25 | 0 | 5.270 | Pass |
| | | 793 | 25 | 0 | 5.236 | Pass |
| | | 795.5 | 25 | 0 | 5.267 | Pass |
| | 16QAM | 790.5 | 25 | 0 | 5.237 | Pass |
| | | 793 | 25 | 0 | 5.261 | Pass |
| | | 795.5 | 25 | 0 | 5.289 | Pass |
| | 64QAM | 790.5 | 25 | 0 | 5.289 | Pass |
| | | 793 | 25 | 0 | 5.309 | Pass |
| | | 795.5 | 25 | 0 | 5.256 | Pass |
| 10 | QPSK | / | / | / | / | Pass |
| | | 793 | 50 | 0 | 10.317 | Pass |
| | | / | / | / | / | Pass |
| | 16QAM | / | / | / | / | Pass |
| | | 793 | 50 | 0 | 10.271 | Pass |
| | | / | / | / | / | Pass |
| | 64QAM | / | / | / | / | Pass |
| | | 793 | 50 | 0 | 10.215 | Pass |
| | | / | / | / | / | Pass |

Test Graph

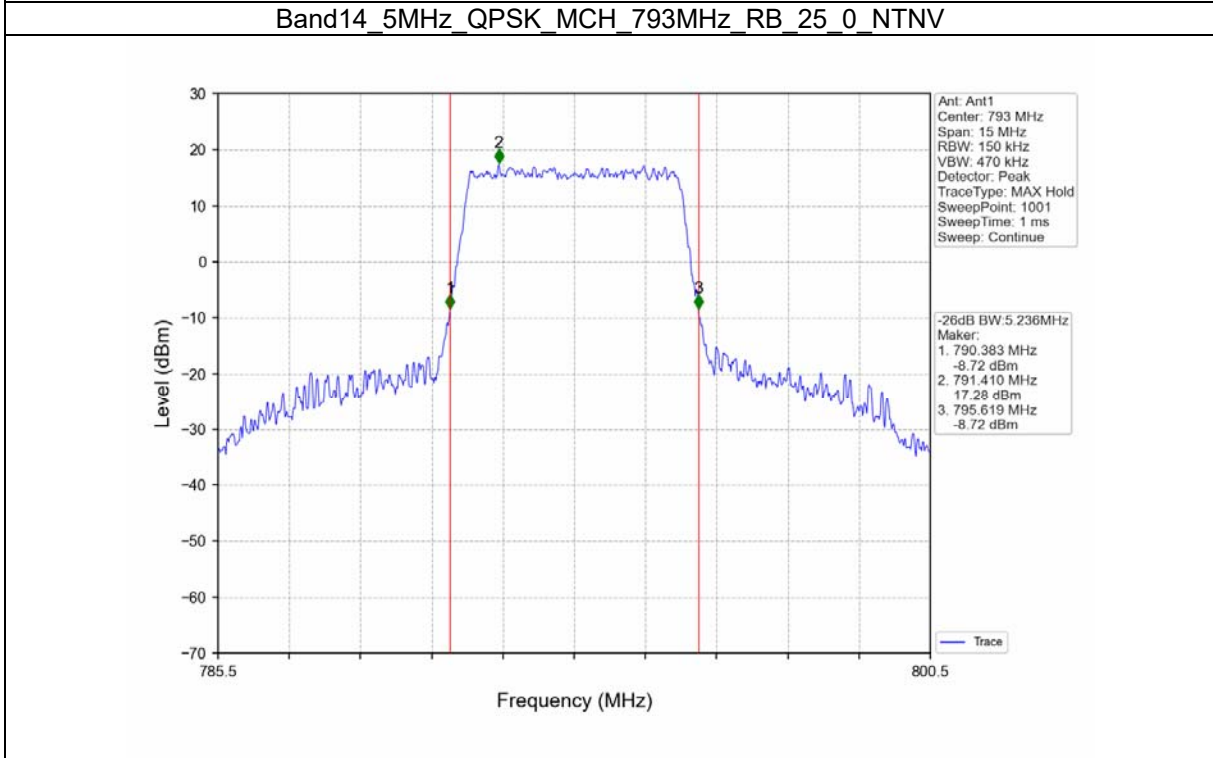
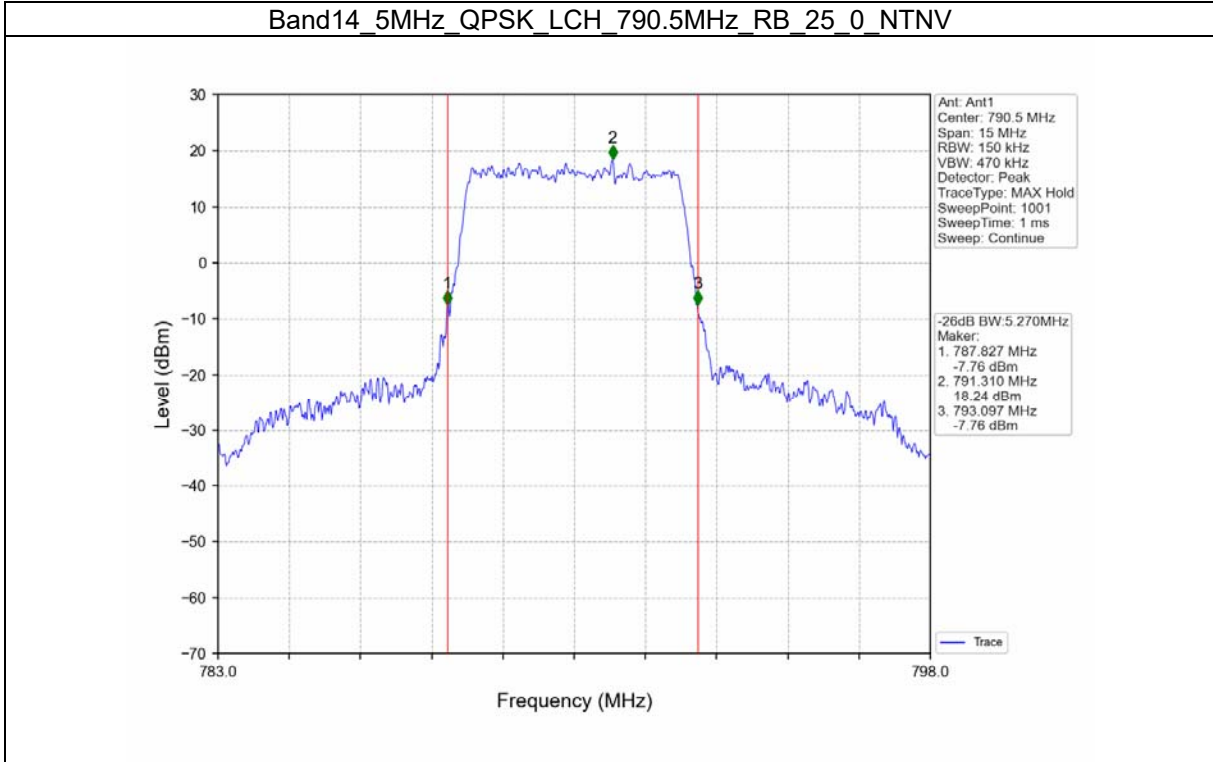

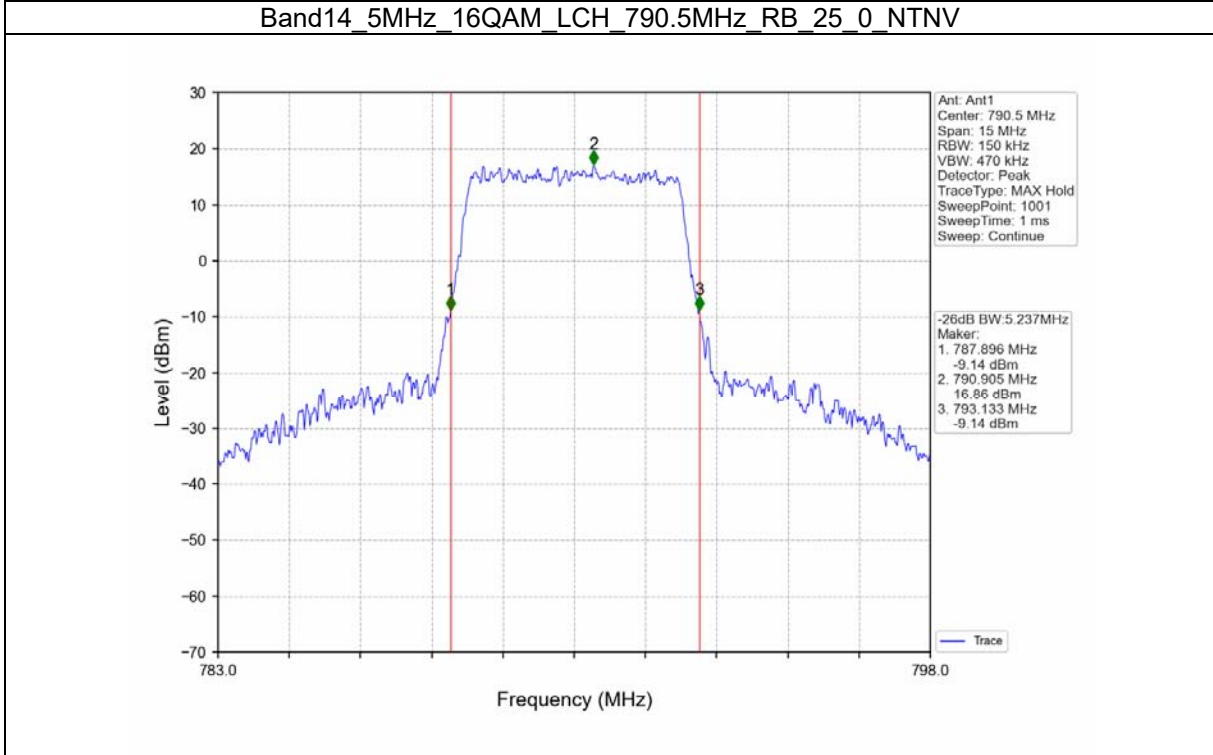
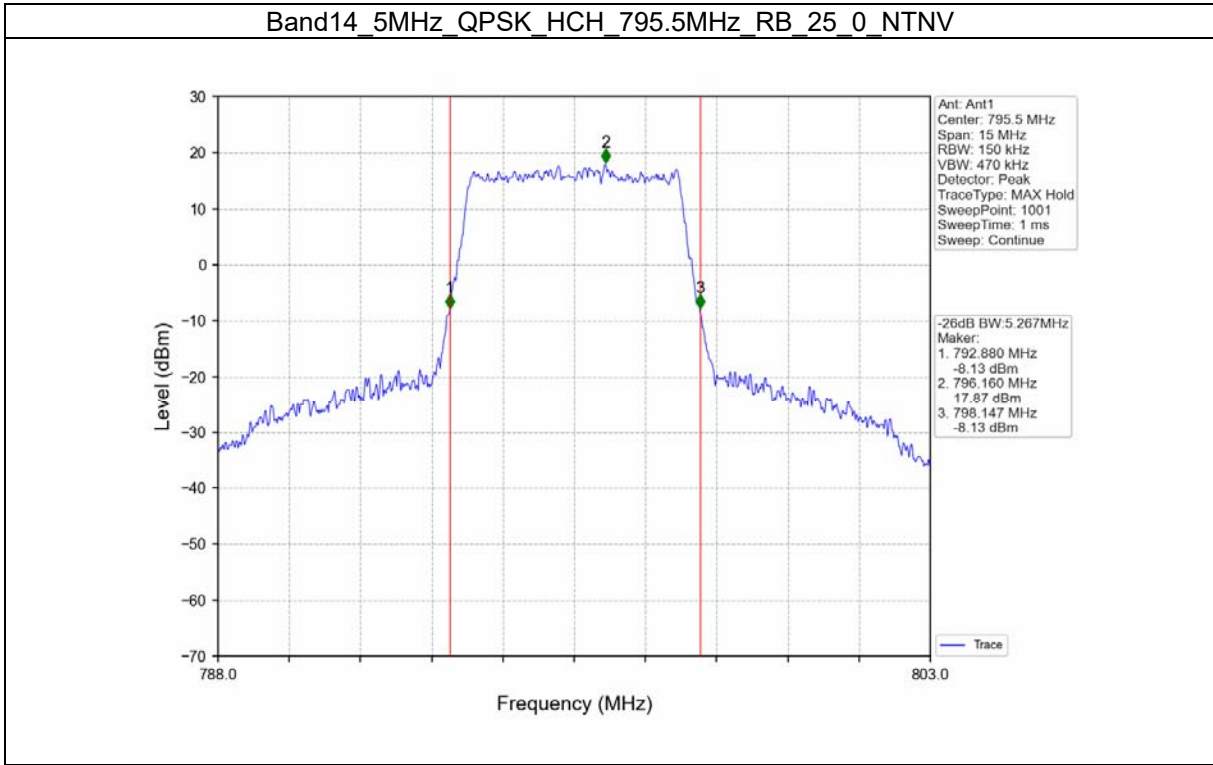

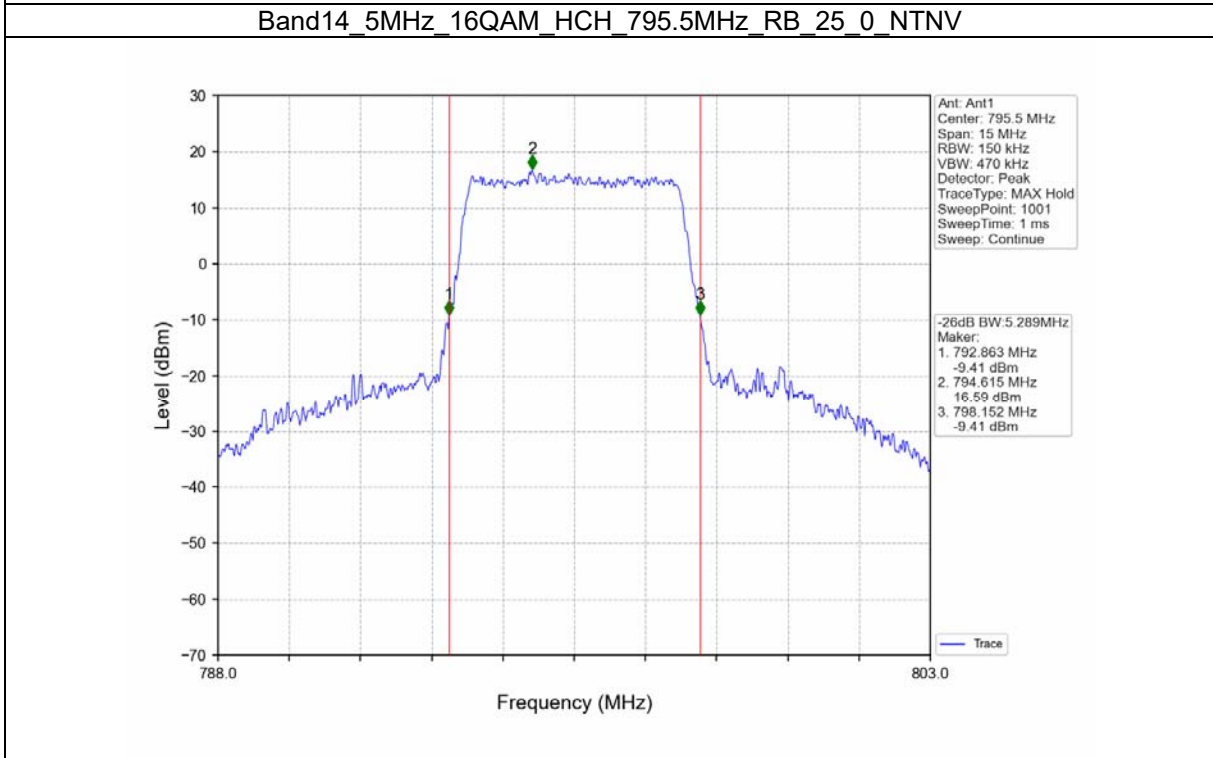
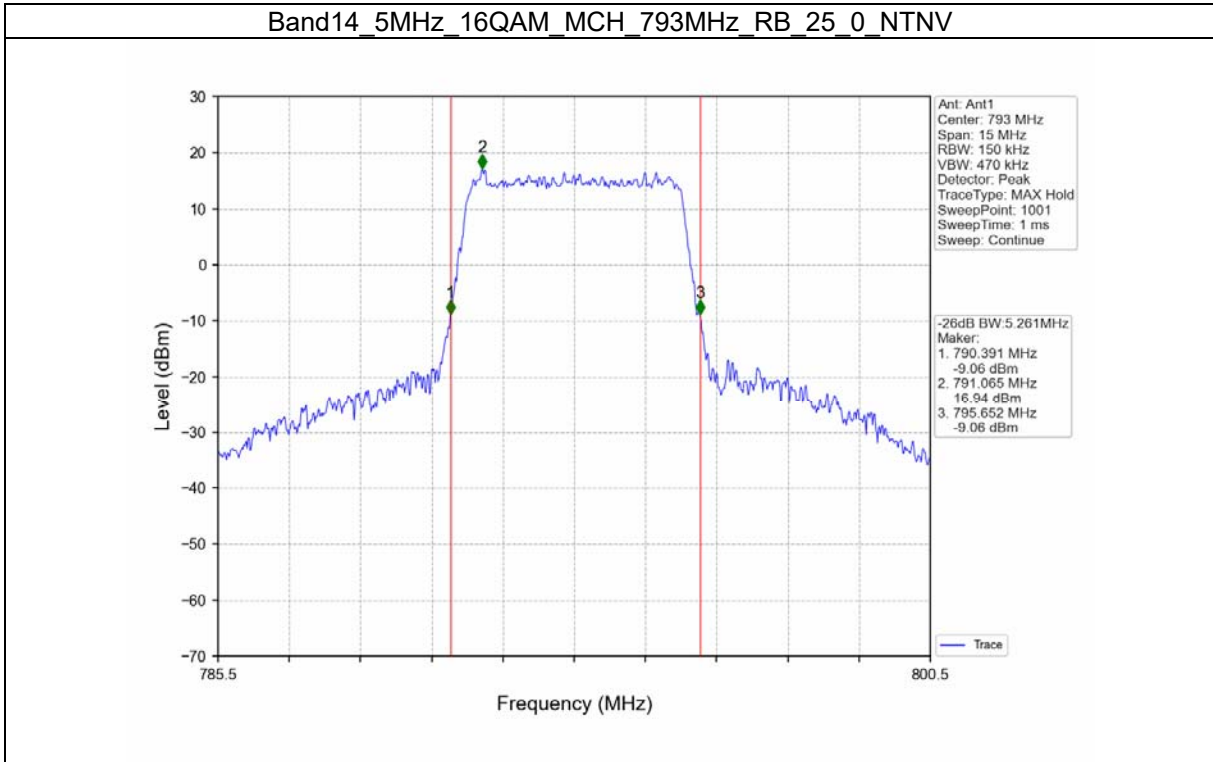

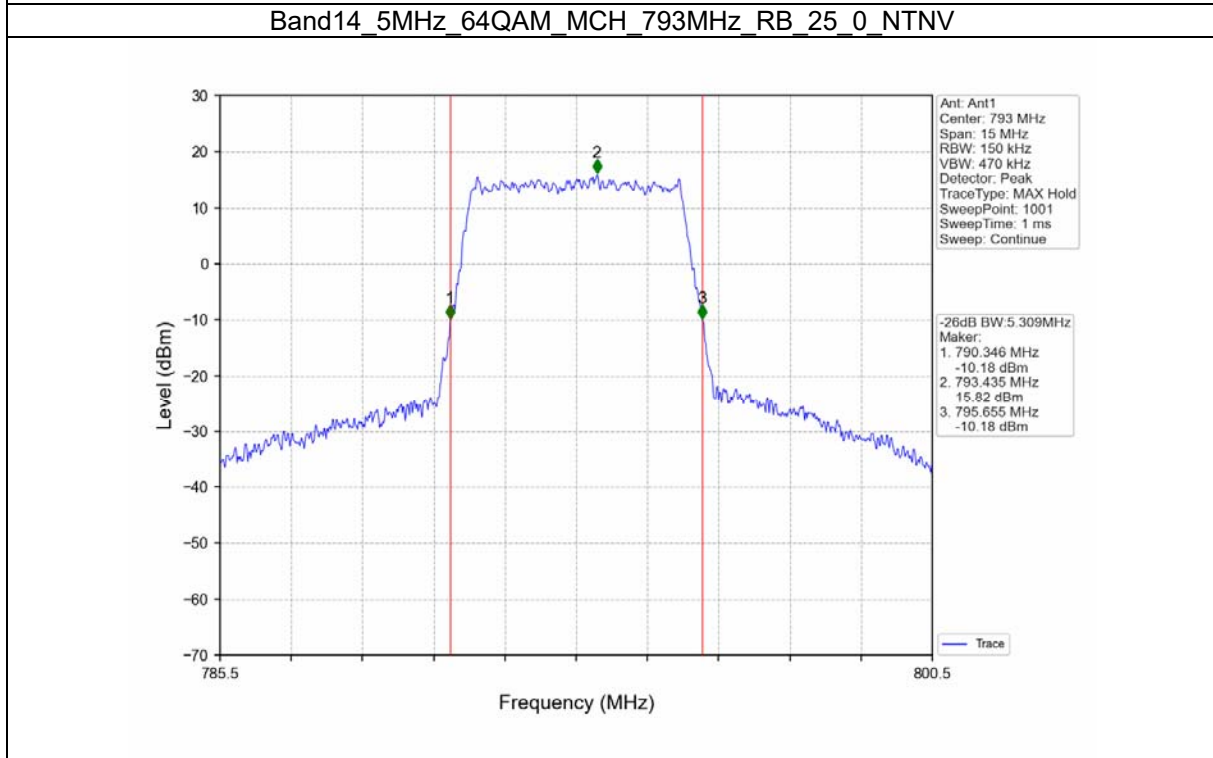
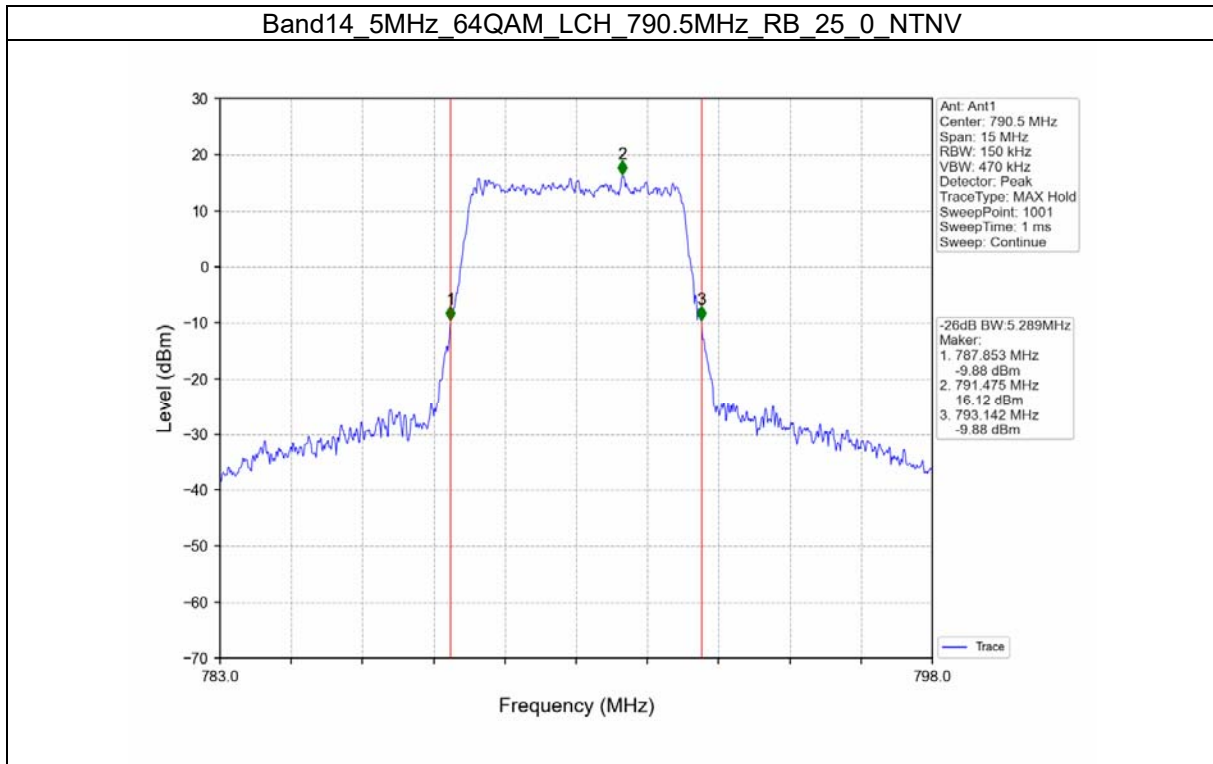

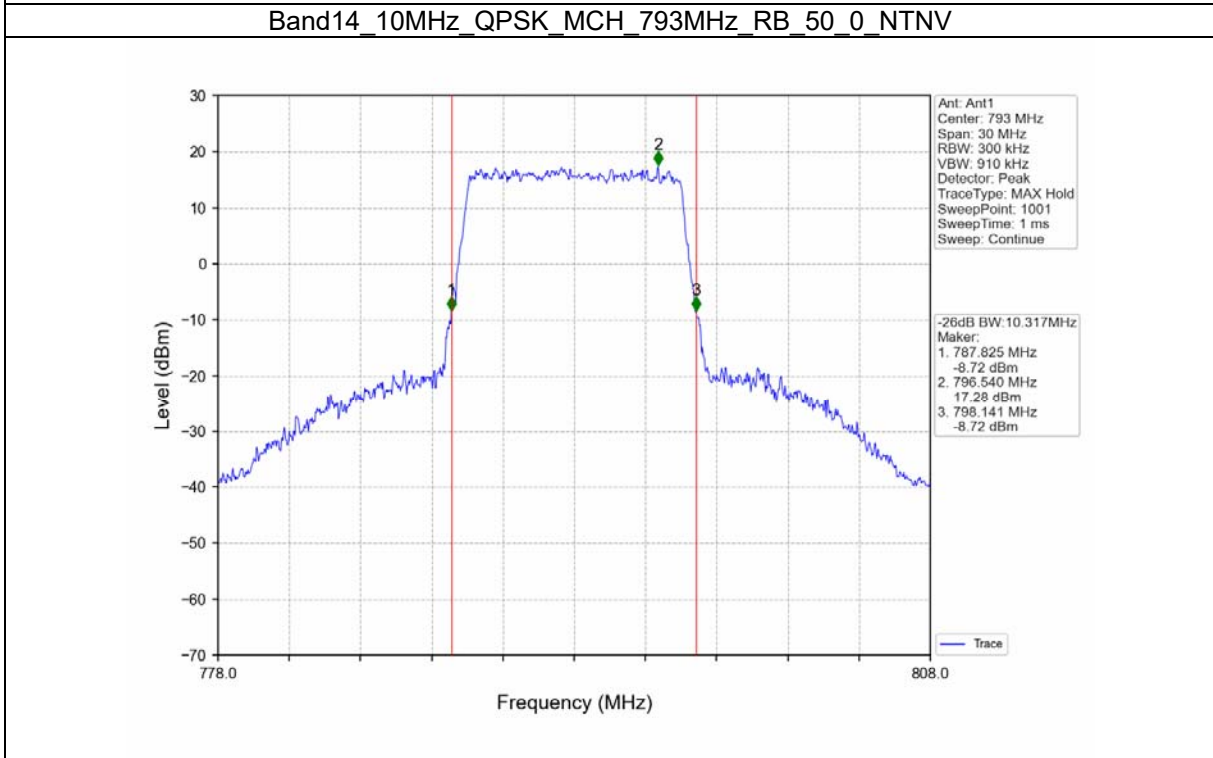
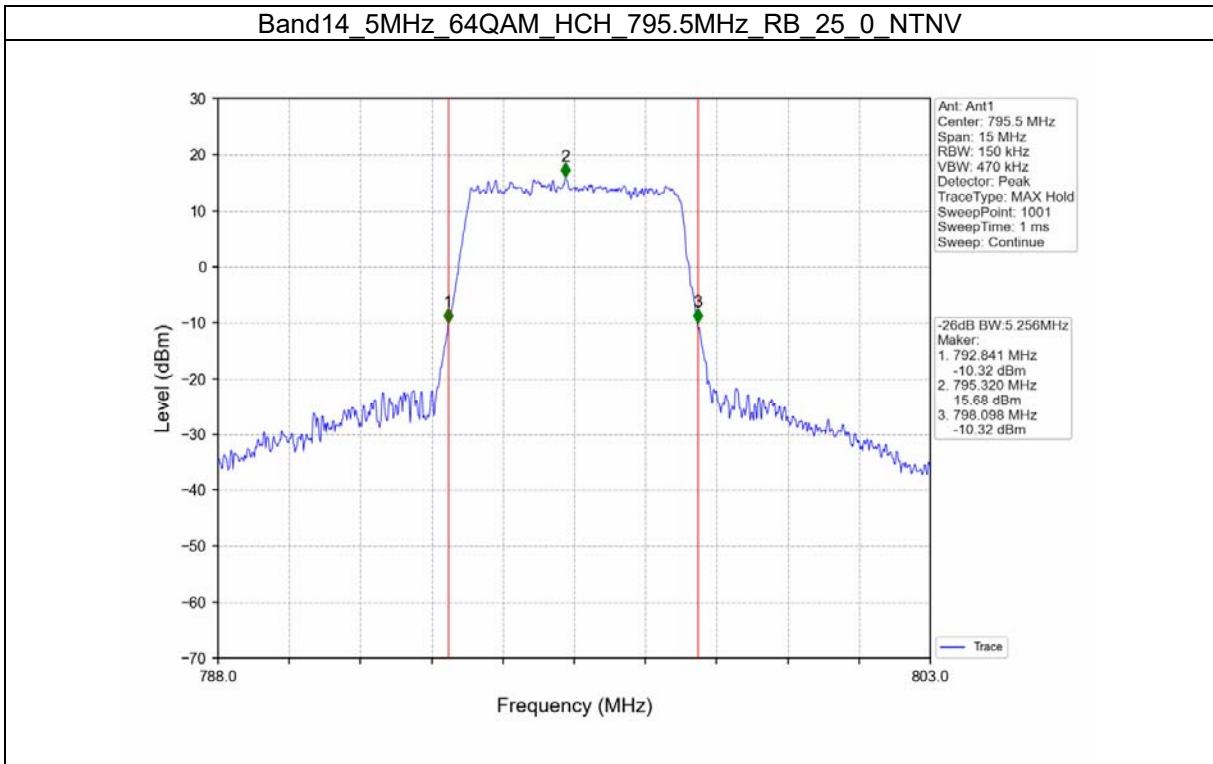

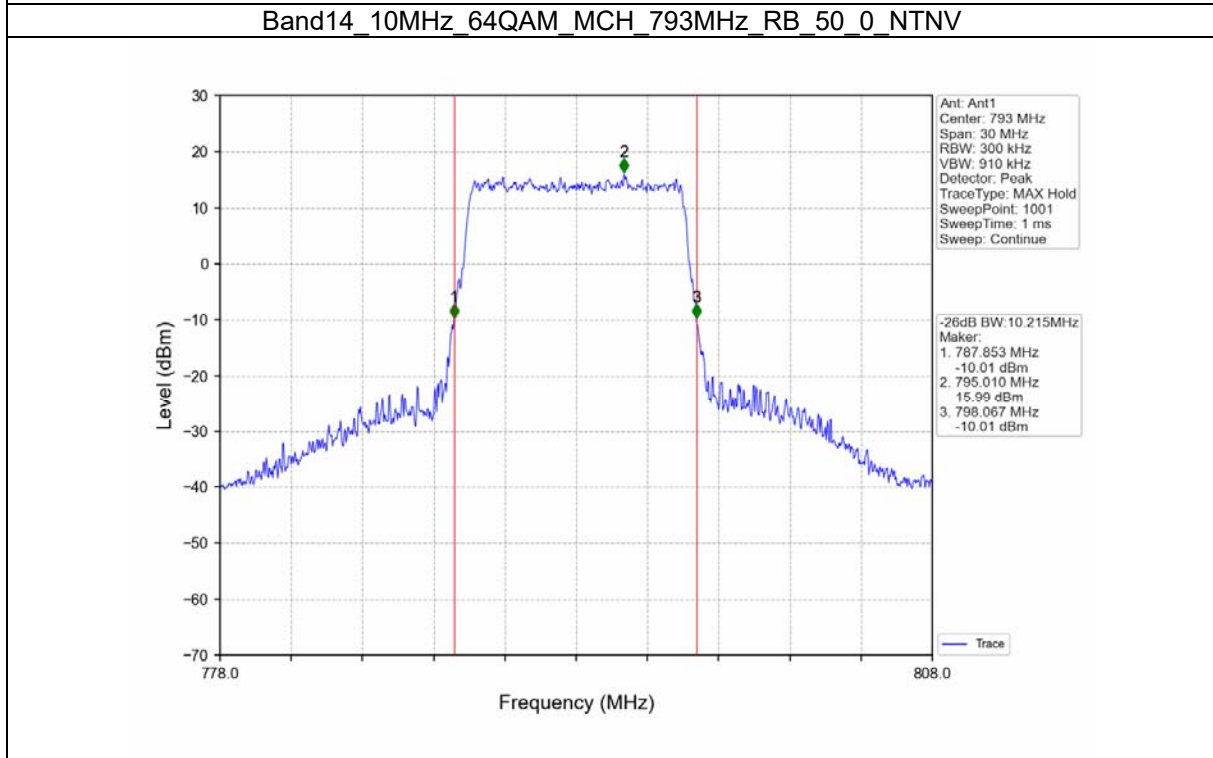
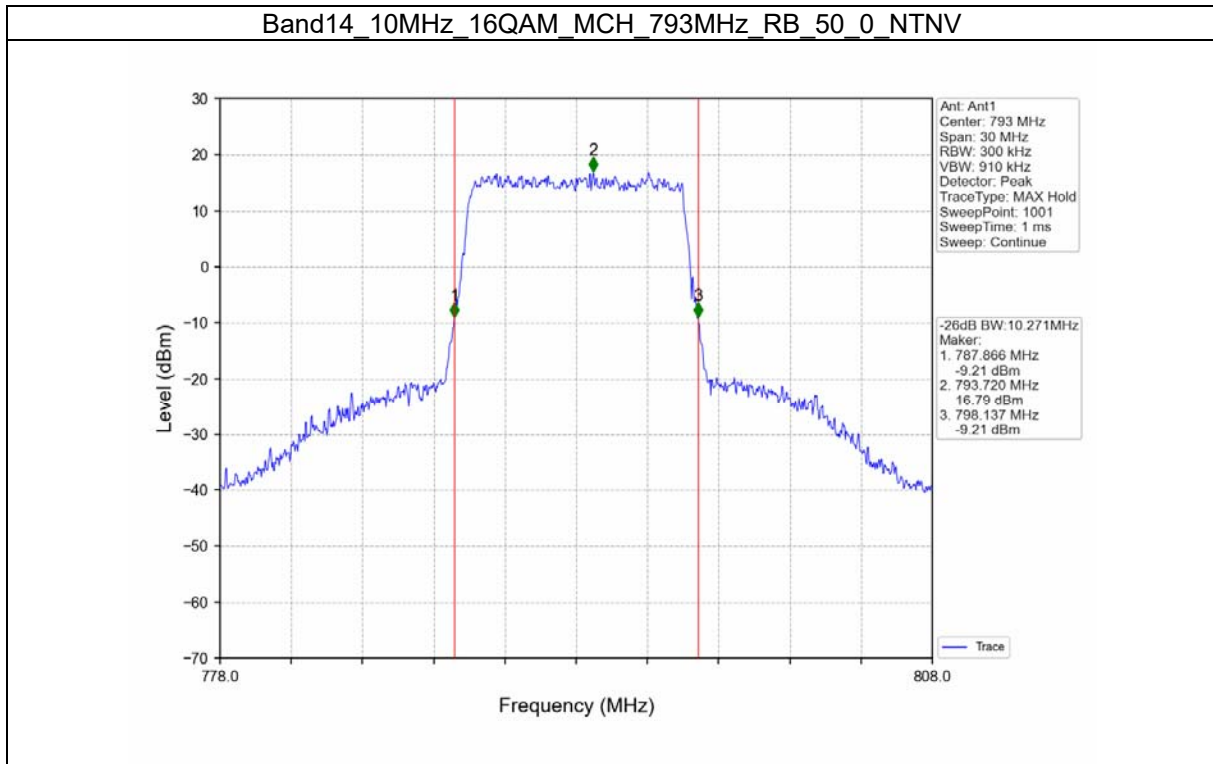



Test Report No.: W7L-220503W001RF07

Peak-Average Ratio

B14_5MHz

Test Result

| Band: 14 / Bandwidth: 5MHz / NTNV | | | | | | |
|-----------------------------------|-----------------|---------------|--------|-------------------------|-------|---------|
| Modulation | Frequency (MHz) | RB Allocation | | Peak-Average Ratio (dB) | | Verdict |
| | | Size | Offset | Result | Limit | |
| QPSK | 790.5 | 25 | 0 | 5.33 | <=13 | Pass |
| | 793 | 25 | 0 | 5.19 | <=13 | Pass |
| | 795.5 | 25 | 0 | 5.16 | <=13 | Pass |
| 16QAM | 790.5 | 25 | 0 | 6.01 | <=13 | Pass |
| | 793 | 25 | 0 | 5.89 | <=13 | Pass |
| | 795.5 | 25 | 0 | 5.88 | <=13 | Pass |
| 64QAM | 790.5 | 25 | 0 | 6.37 | <=13 | Pass |
| | 793 | 25 | 0 | 6.26 | <=13 | Pass |
| | 795.5 | 25 | 0 | 6.26 | <=13 | Pass |



Test Report No.: W7L-220503W001RF07

Test Graph

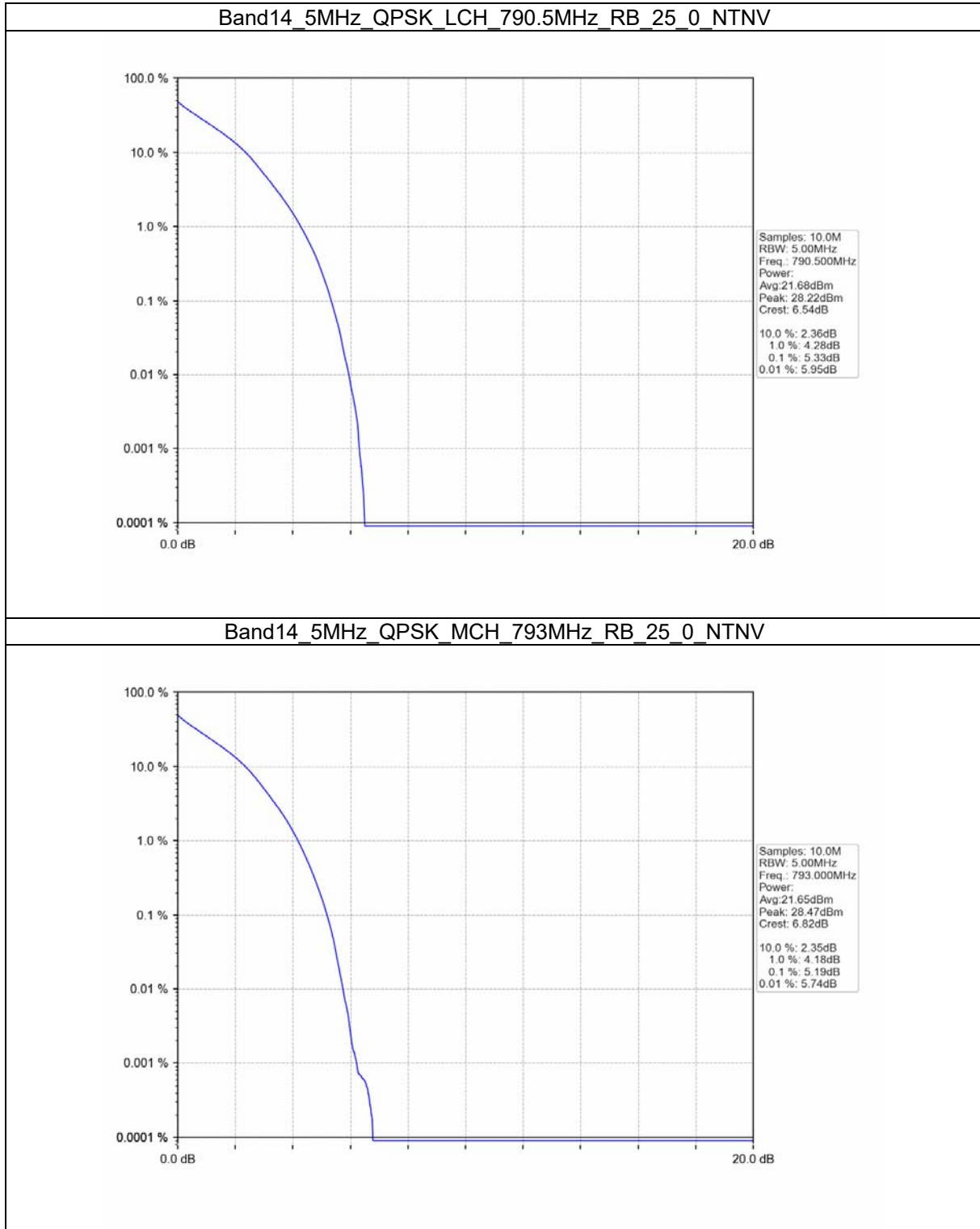



Test Report No.: W7L-220503W001RF07

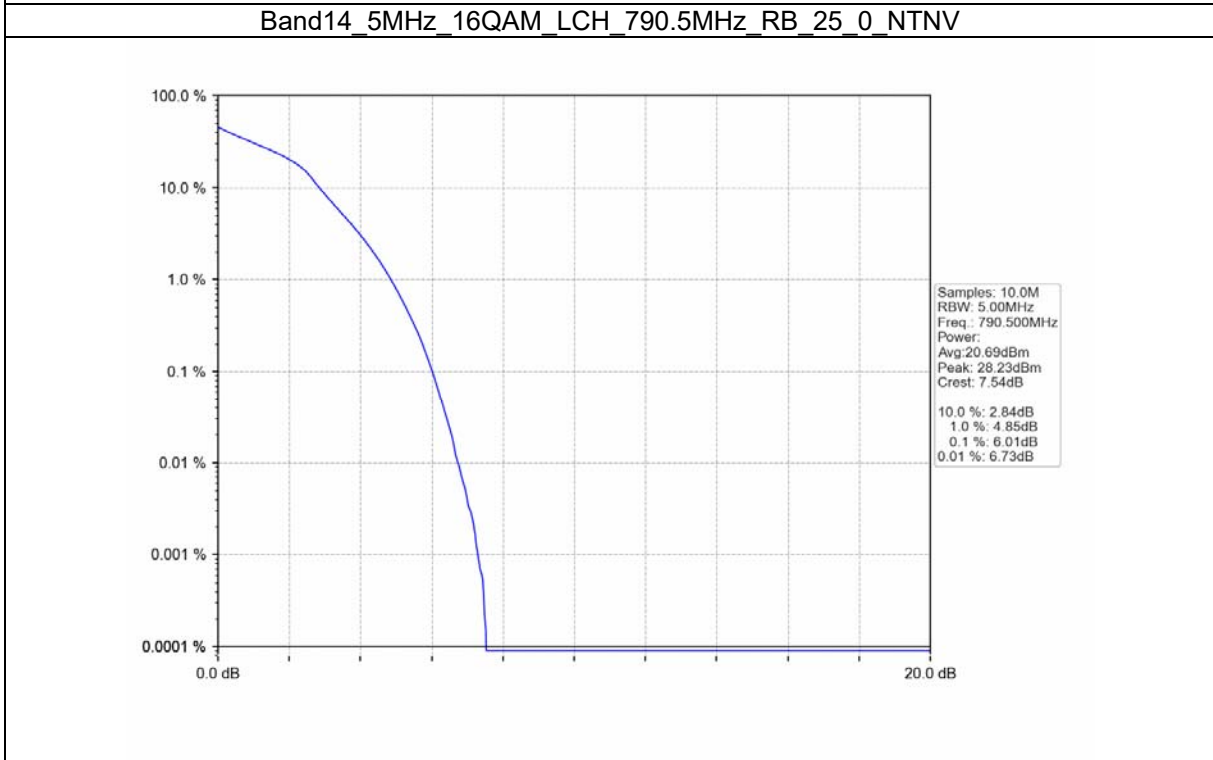
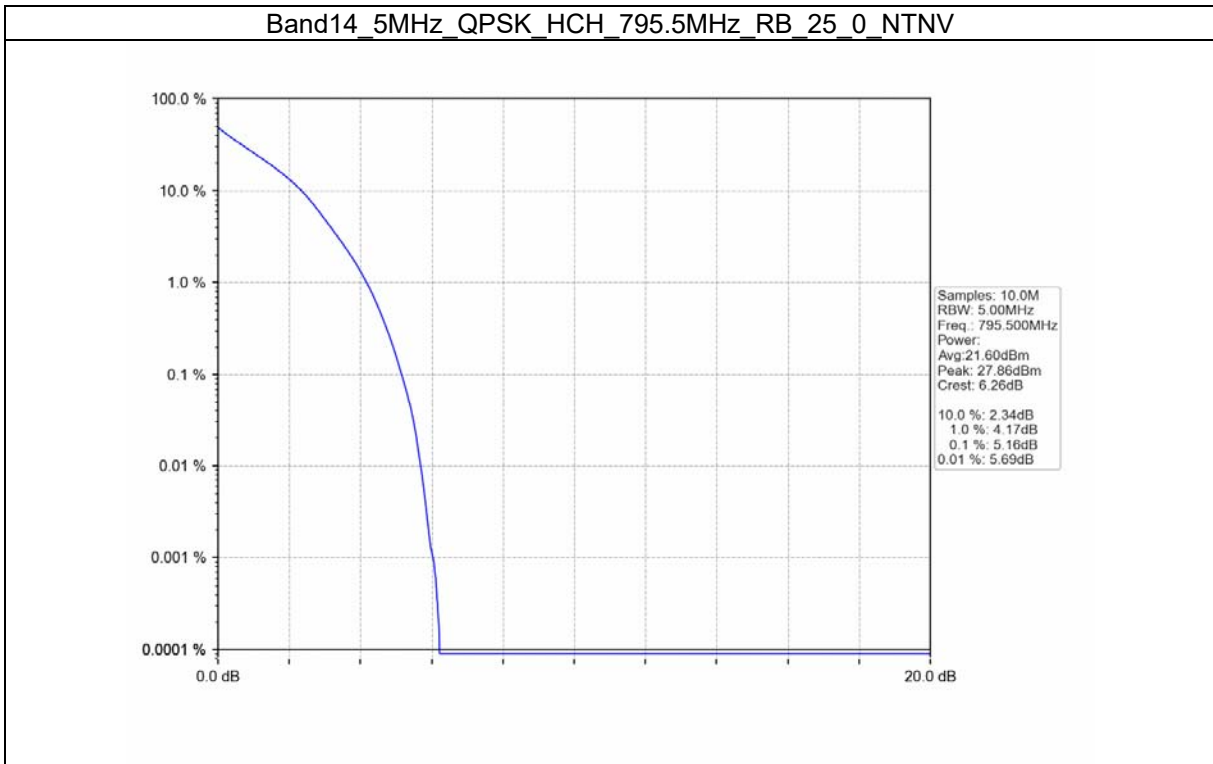



Test Report No.: W7L-220503W001RF07

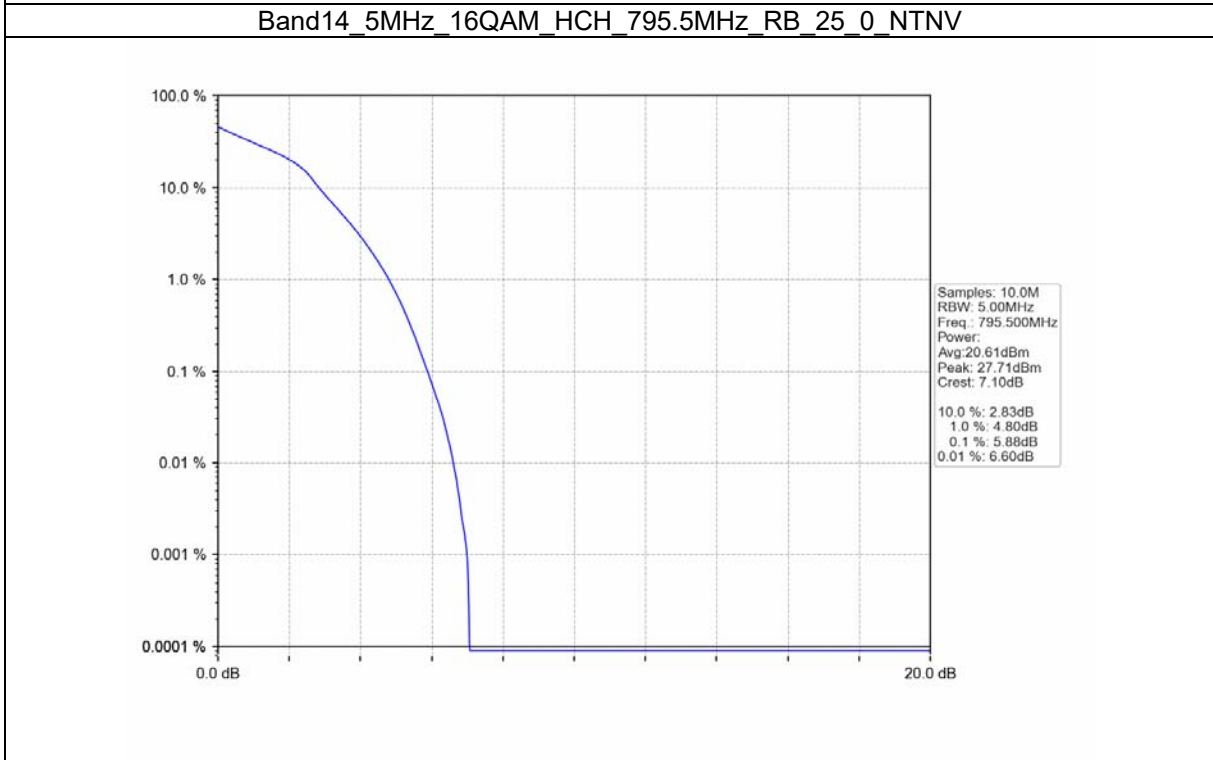
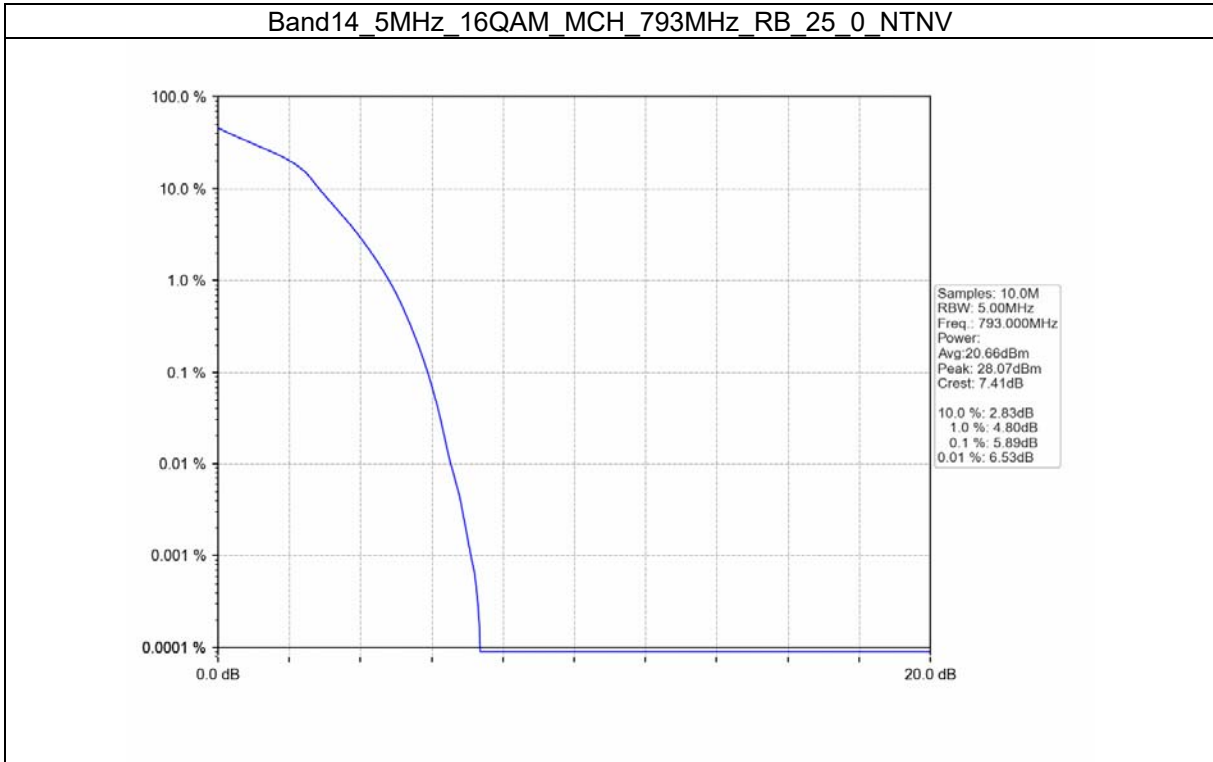



Test Report No.: W7L-220503W001RF07

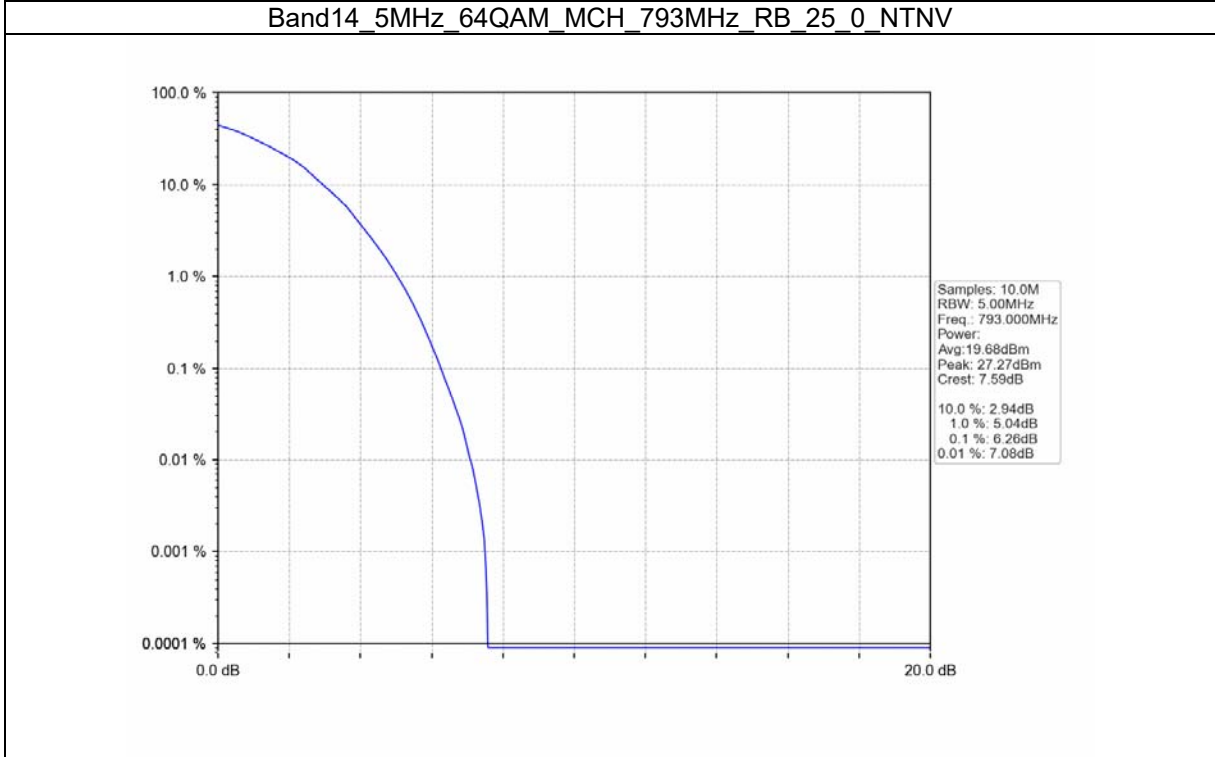
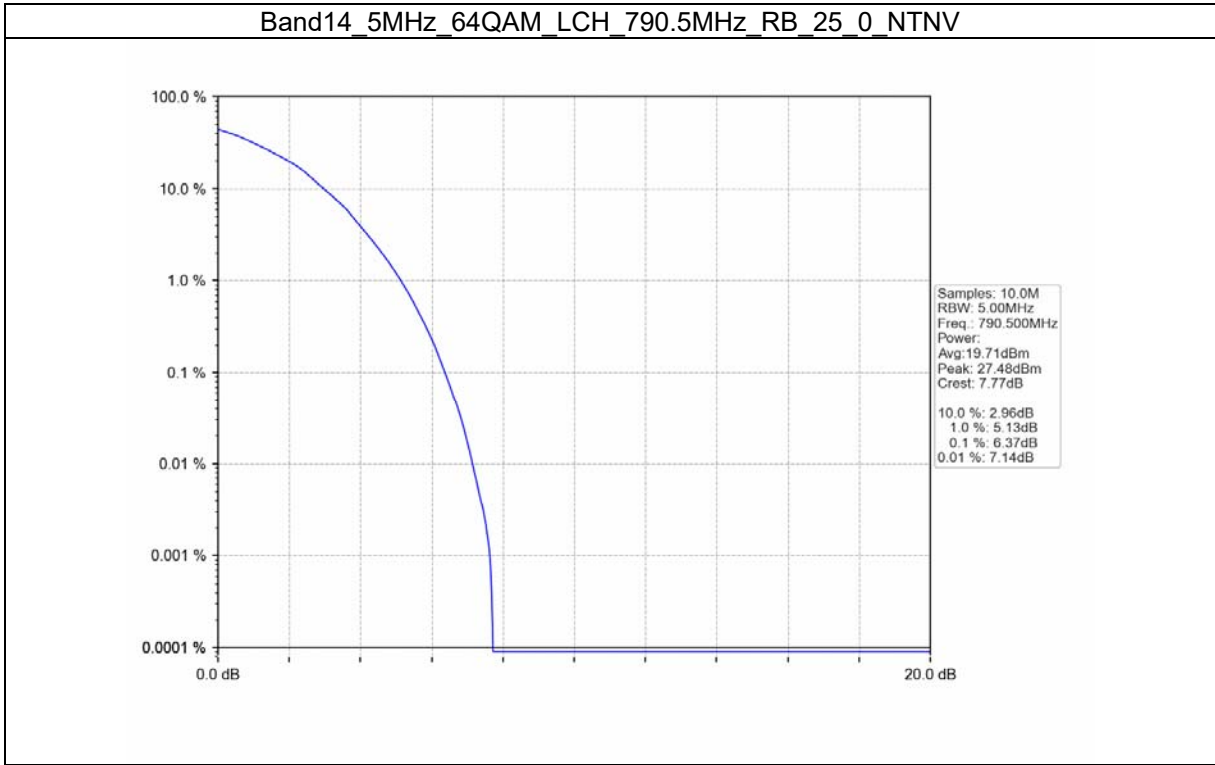



Test Report No.: W7L-220503W001RF07

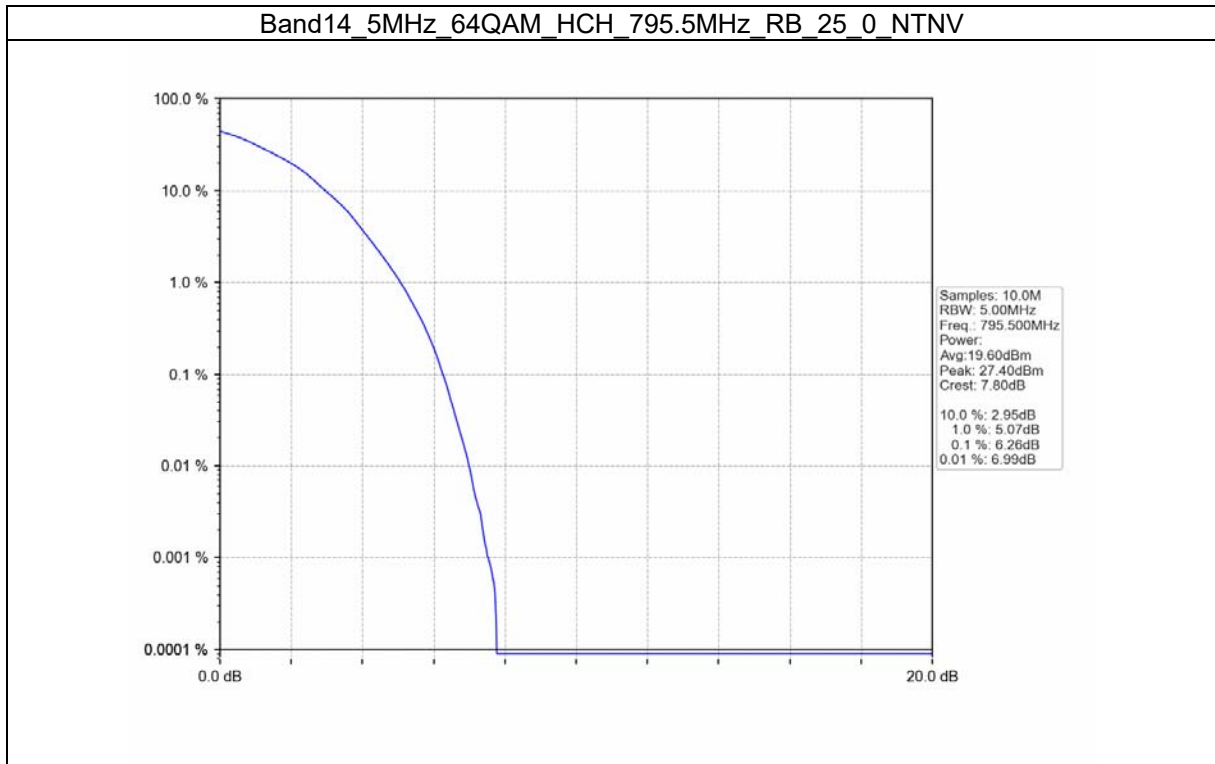



Test Report No.: W7L-220503W001RF07

B14_10MHz

Test Result

| Band: 14 / Bandwidth: 10MHz / NTN | | | | | | |
|-----------------------------------|-----------------|---------------|--------|-------------------------|-------|---------|
| Modulation | Frequency (MHz) | RB Allocation | | Peak-Average Ratio (dB) | | Verdict |
| | | Size | Offset | Result | Limit | |
| QPSK | 793 | / | / | / | <=13 | Pass |
| | 793 | 50 | 0 | 4.66 | <=13 | Pass |
| | 793 | / | / | / | <=13 | Pass |
| 16QAM | 793 | / | / | / | <=13 | Pass |
| | 793 | 50 | 0 | 5.99 | <=13 | Pass |
| | 793 | / | / | / | <=13 | Pass |
| 64QAM | 793 | / | / | / | <=13 | Pass |
| | 793 | 50 | 0 | 6.33 | <=13 | Pass |
| | 793 | / | / | / | <=13 | Pass |



Test Report No.: W7L-220503W001RF07

Test Graph

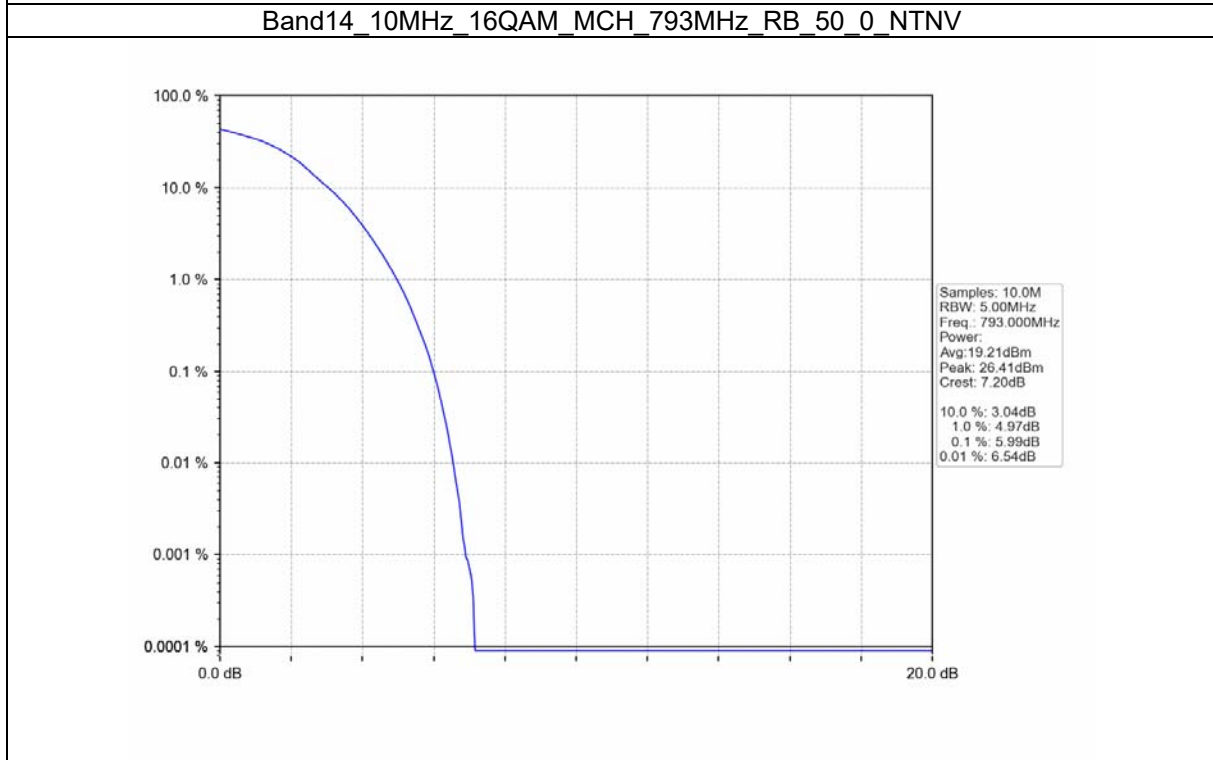
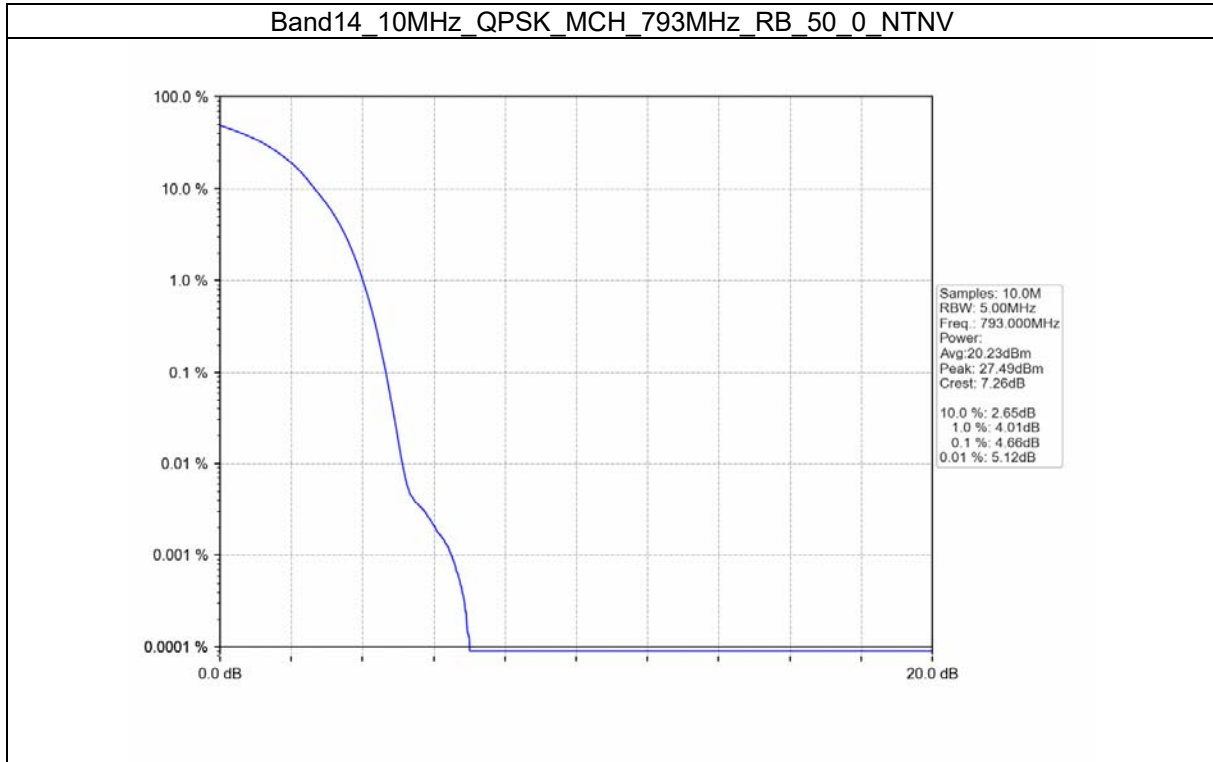



Test Report No.: W7L-220503W001RF07

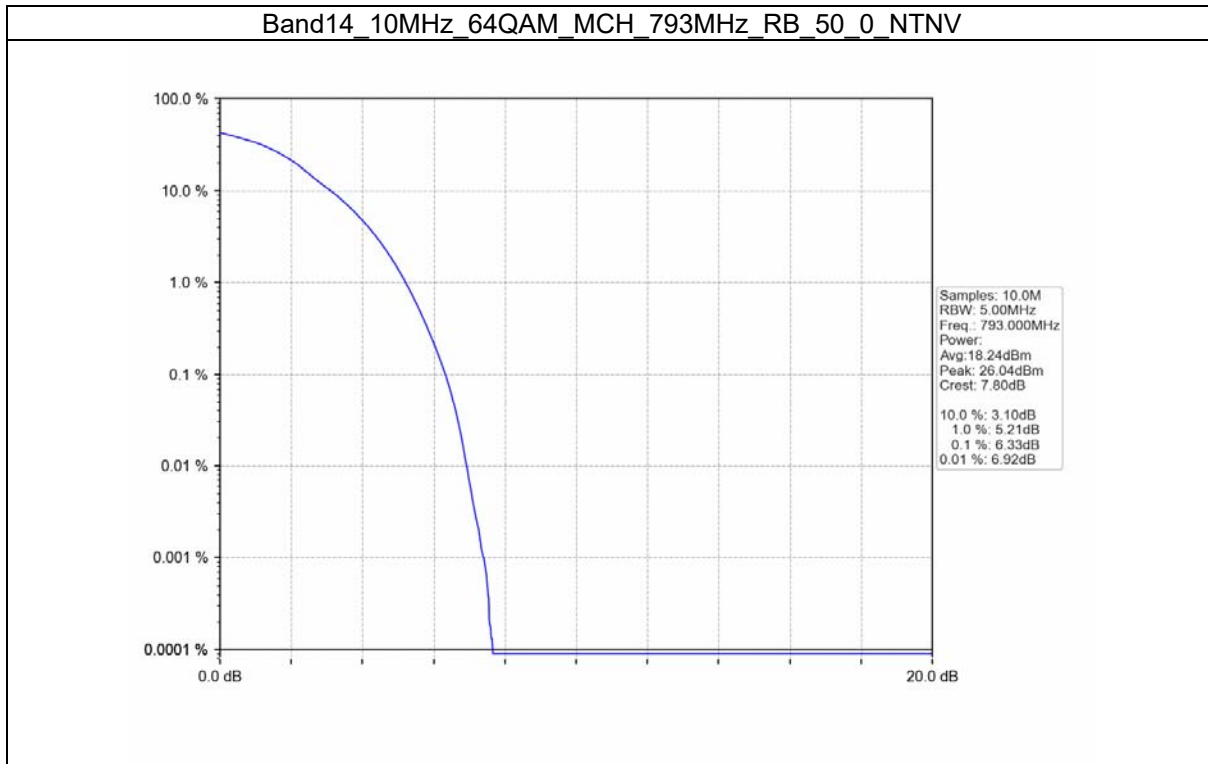



Test Report No.: W7L-220503W001RF07

Spurious Emission

B14_5MHz

Test Result

| Band: 14 / Bandwidth: 5MHz / NTNV | | | | | | |
|-----------------------------------|-----------------|---------------|--------|---------------------|-------|-------------|
| Modulation | Frequency (MHz) | RB Allocation | | Spurious Emission | | Verdict |
| | | Size | Offset | Result | Limit | |
| QPSK | 790.5 | 1 | 0 | Refer To Test Graph | | Pass |
| | | 25 | 0 | Refer To Test Graph | | Pass |
| | 793 | 1 | 0 | Refer To Test Graph | | Pass |
| | 795.5 | 1 | 0 | Refer To Test Graph | | Pass |
| | | | 24 | Refer To Test Graph | | Pass |
| | | 25 | 0 | Refer To Test Graph | | Pass |
| 16QAM | 790.5 | 1 | 0 | Refer To Test Graph | | Pass |
| | | 25 | 0 | Refer To Test Graph | | Pass |
| | 793 | 1 | 0 | Refer To Test Graph | | Pass |
| | 795.5 | 1 | 0 | Refer To Test Graph | | Pass |
| | | | 24 | Refer To Test Graph | | Pass |
| | | 25 | 0 | Refer To Test Graph | | Pass |
| 64QAM | 790.5 | 1 | 0 | Refer To Test Graph | | Pass |
| | | 25 | 0 | Refer To Test Graph | | Pass |
| | 793 | 1 | 0 | Refer To Test Graph | | Pass |
| | 795.5 | 1 | 0 | Refer To Test Graph | | Pass |
| | | | 24 | Refer To Test Graph | | Pass |
| | | 25 | 0 | Refer To Test Graph | | Pass |

Test Graph

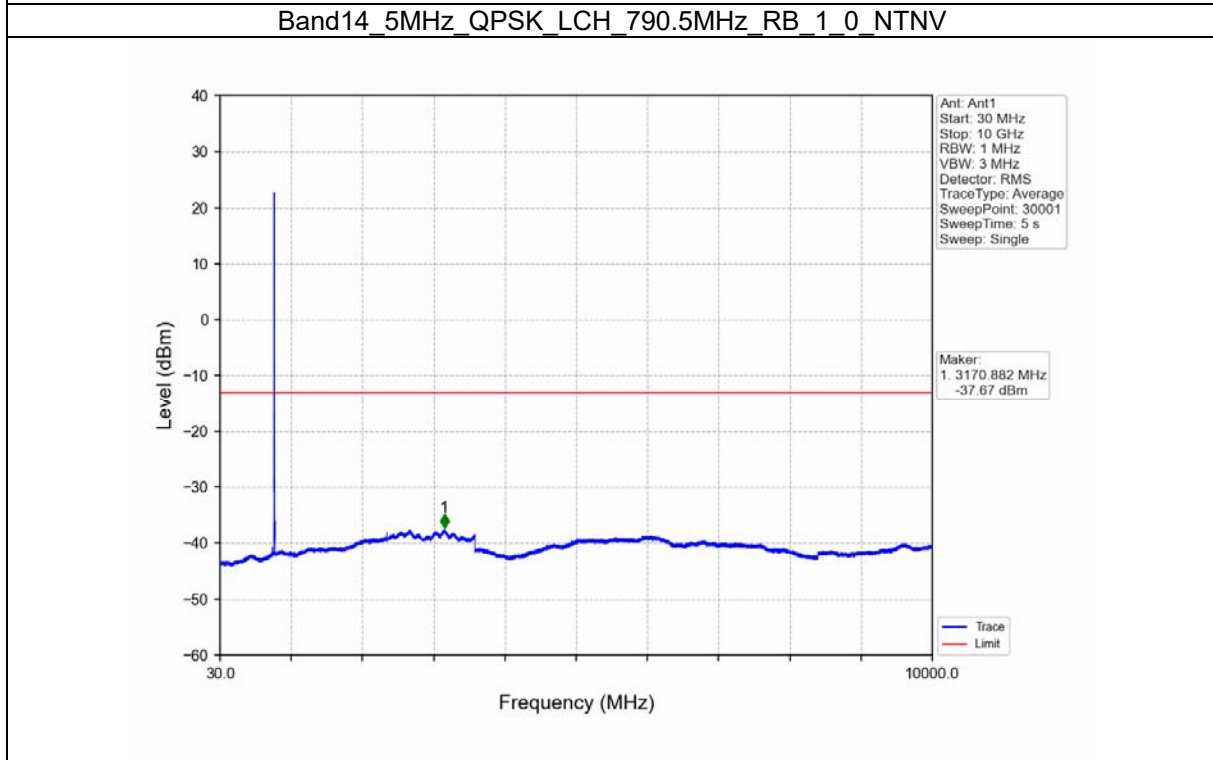
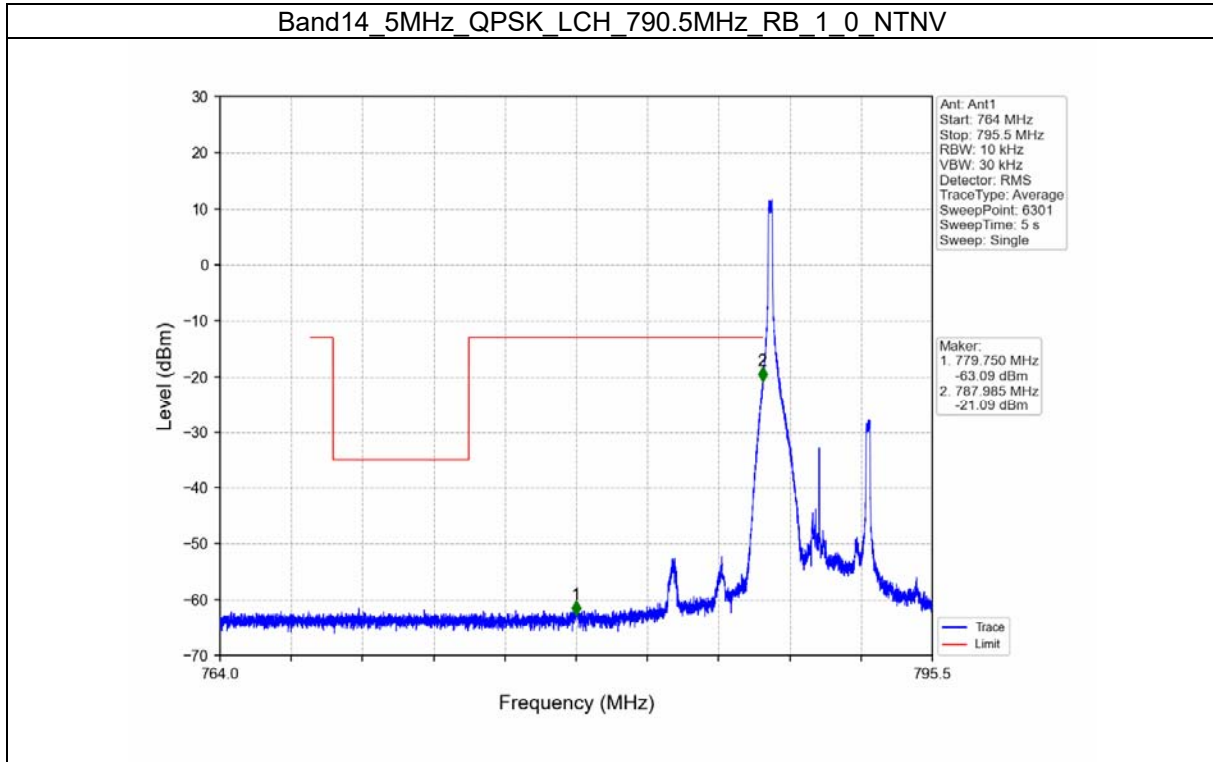

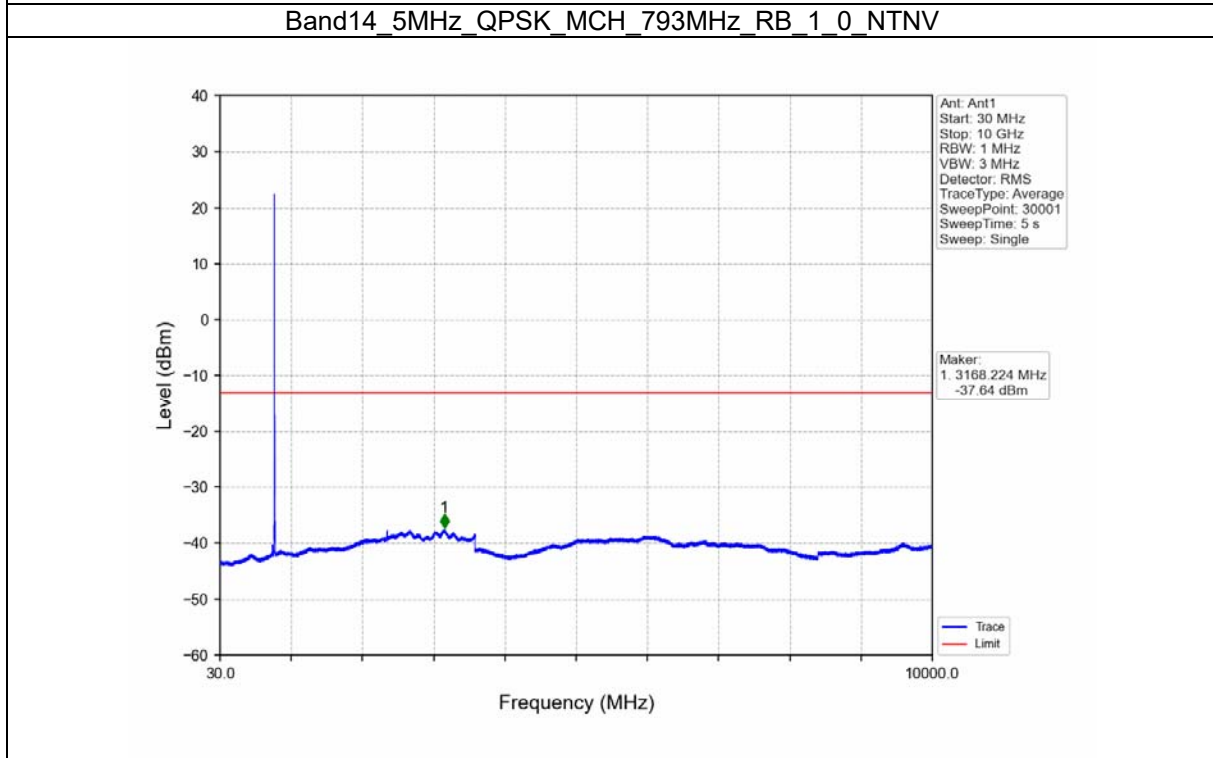
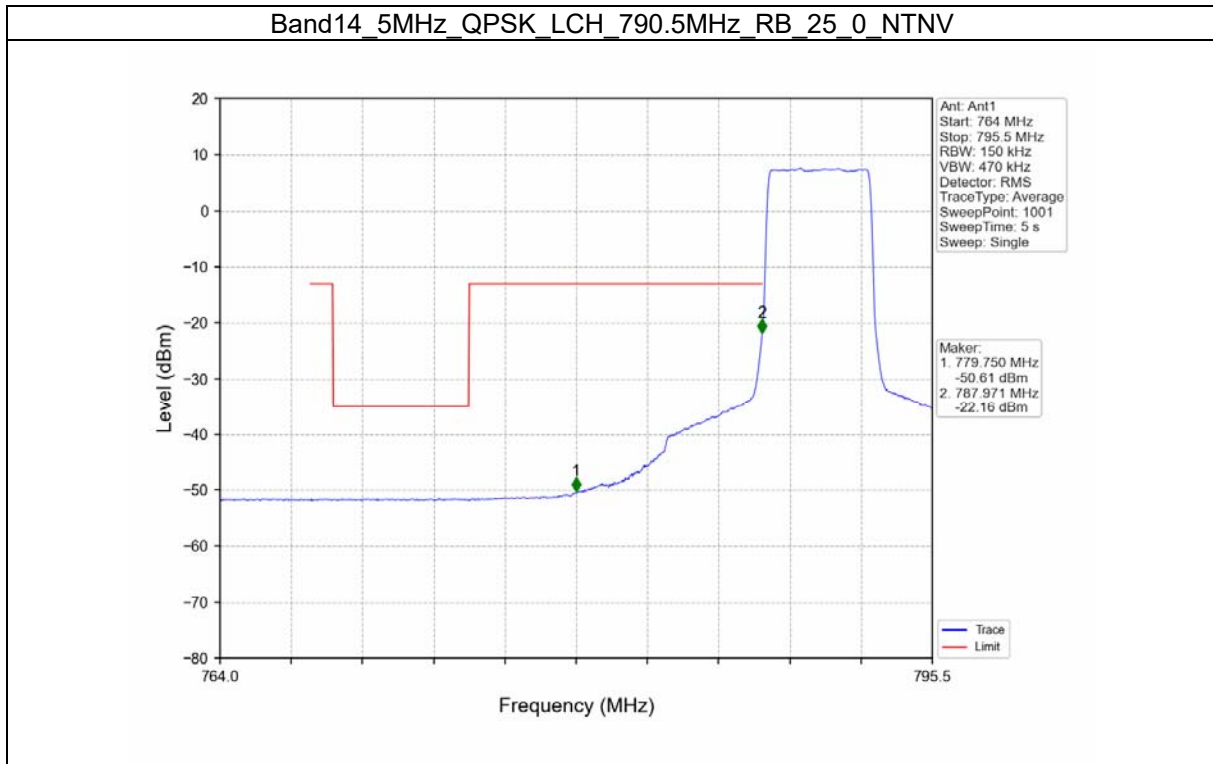

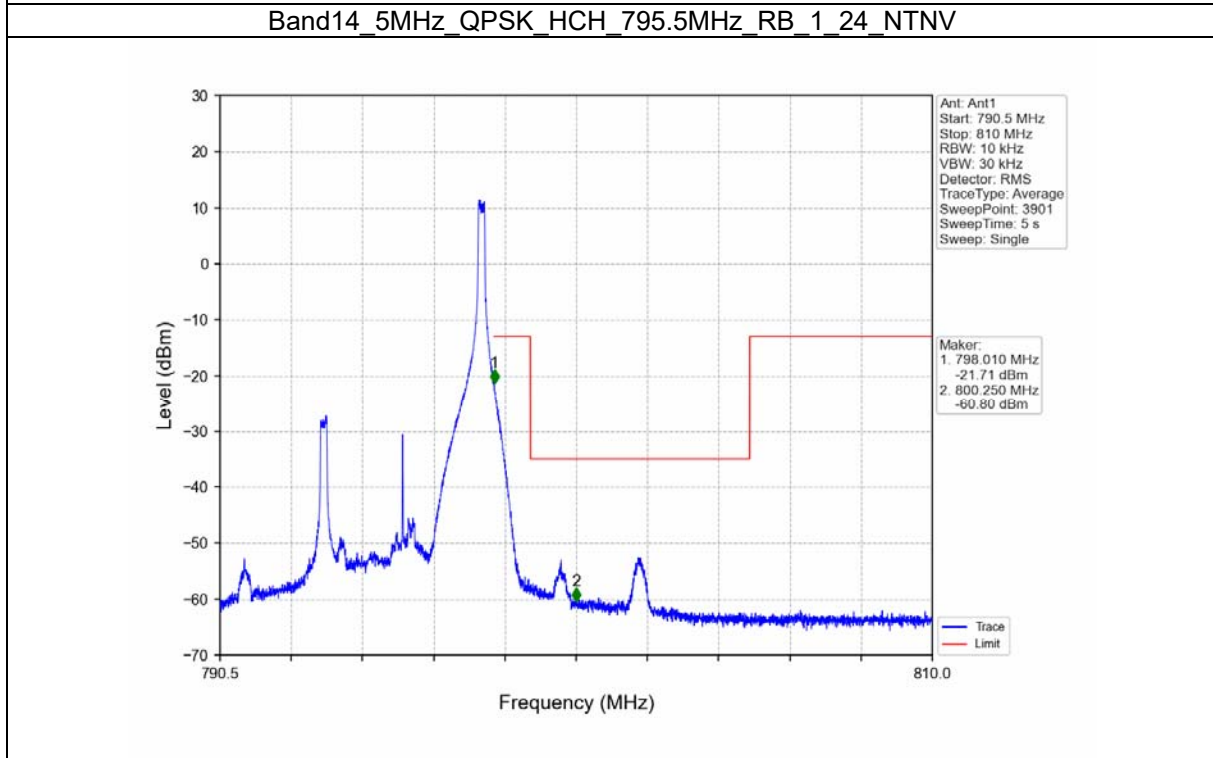
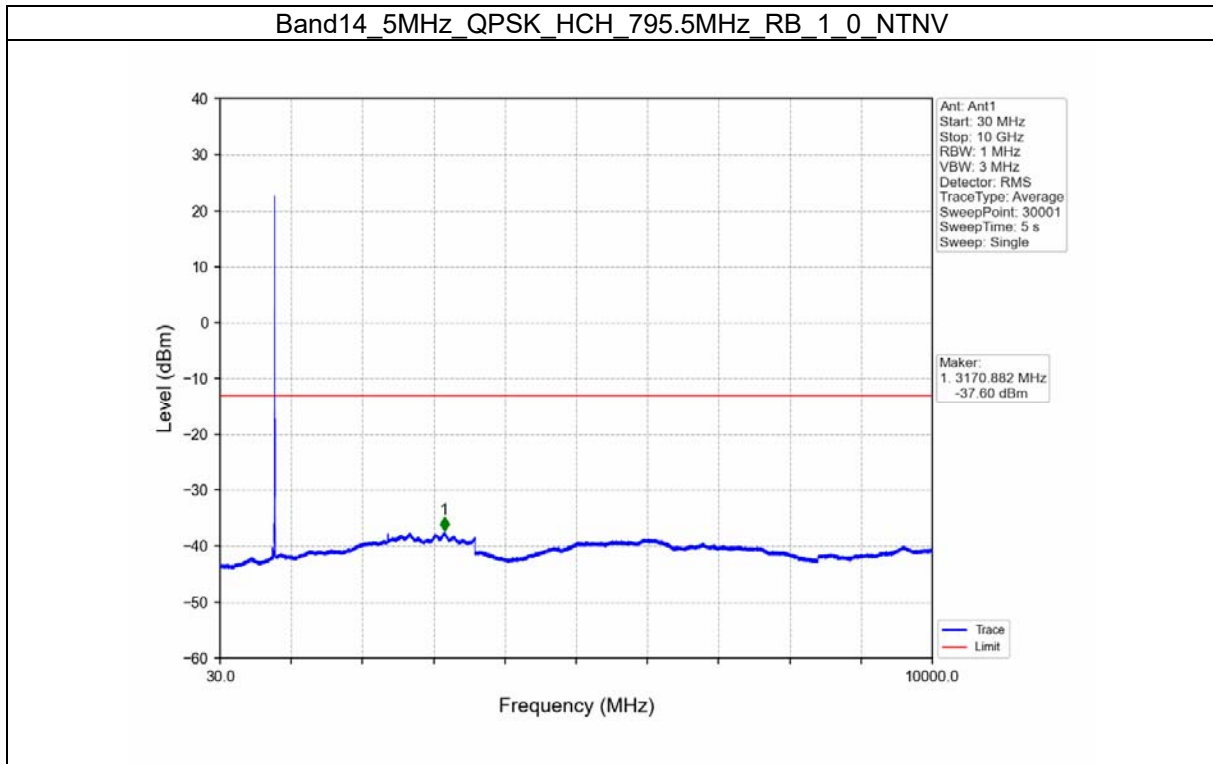



Test Report No.: W7L-220503W001RF07

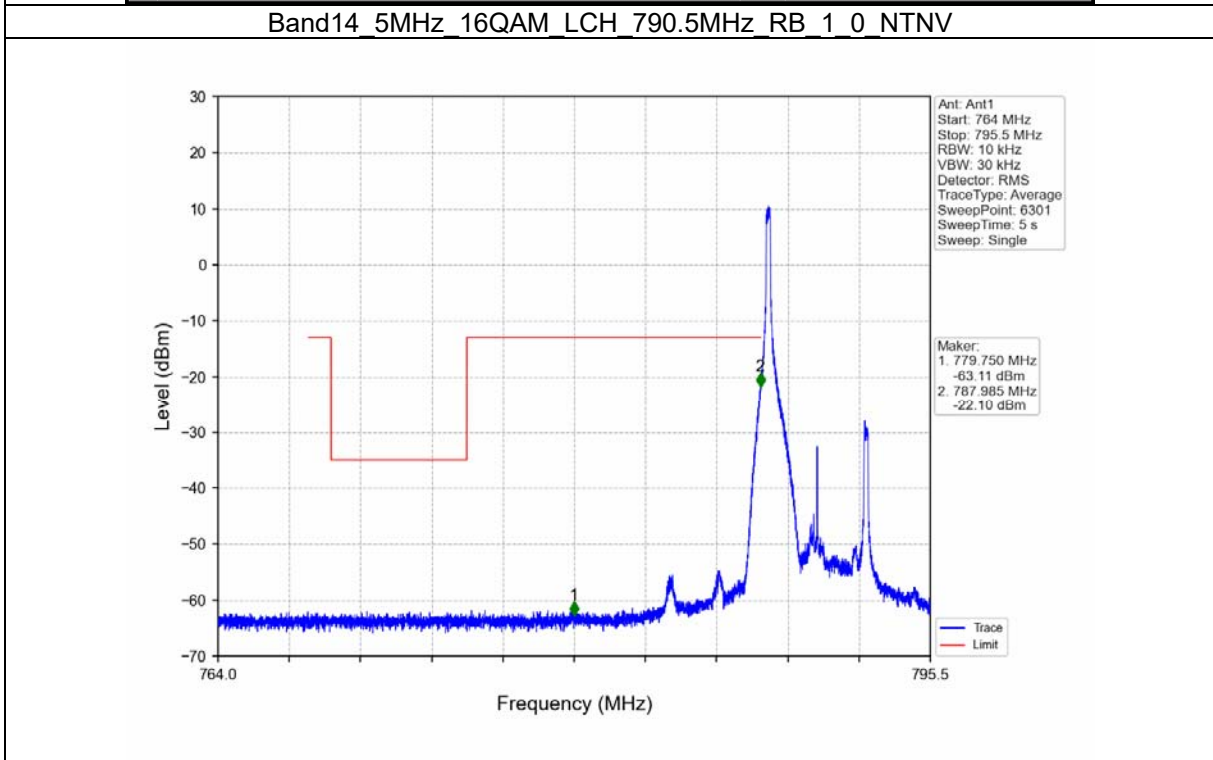
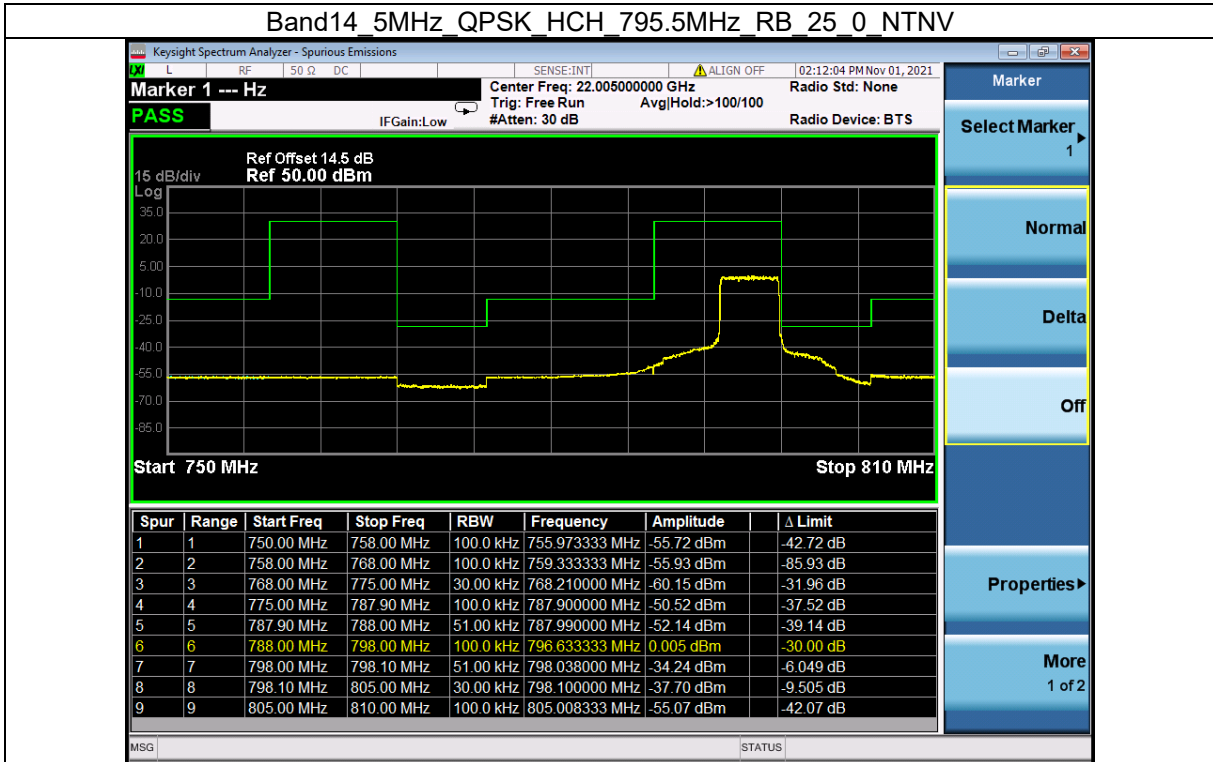

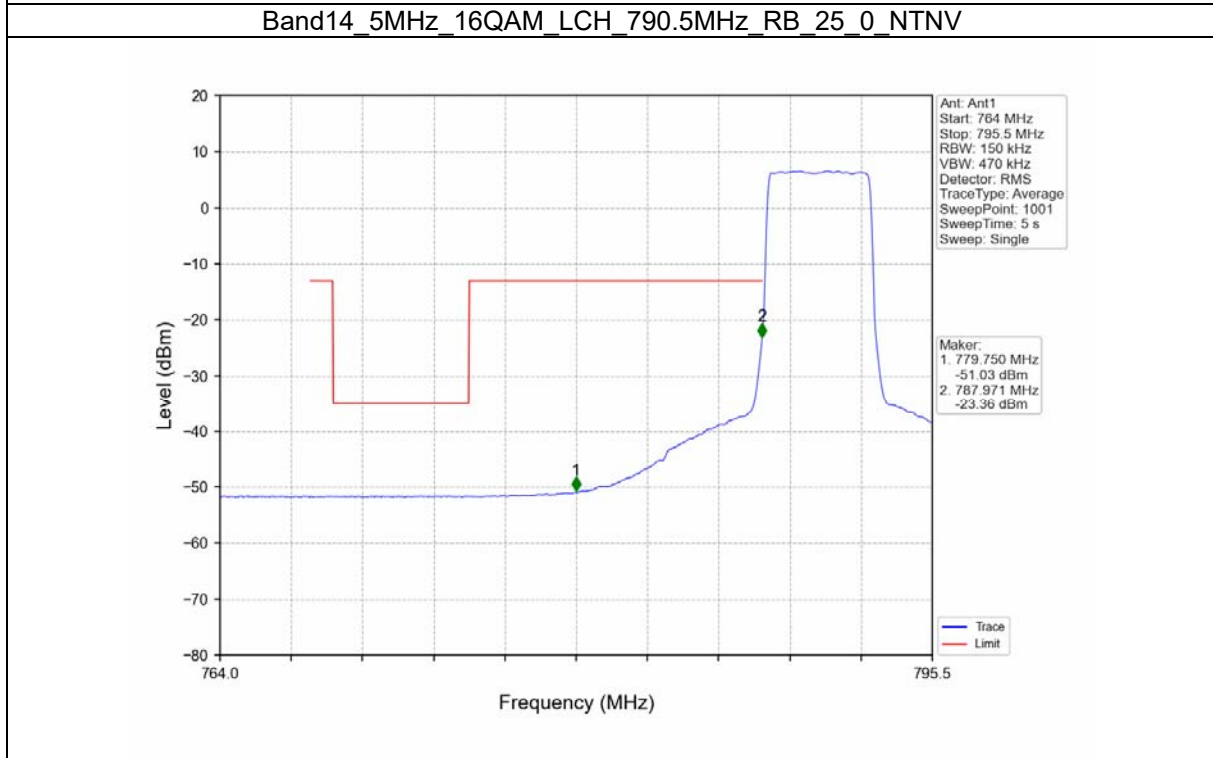
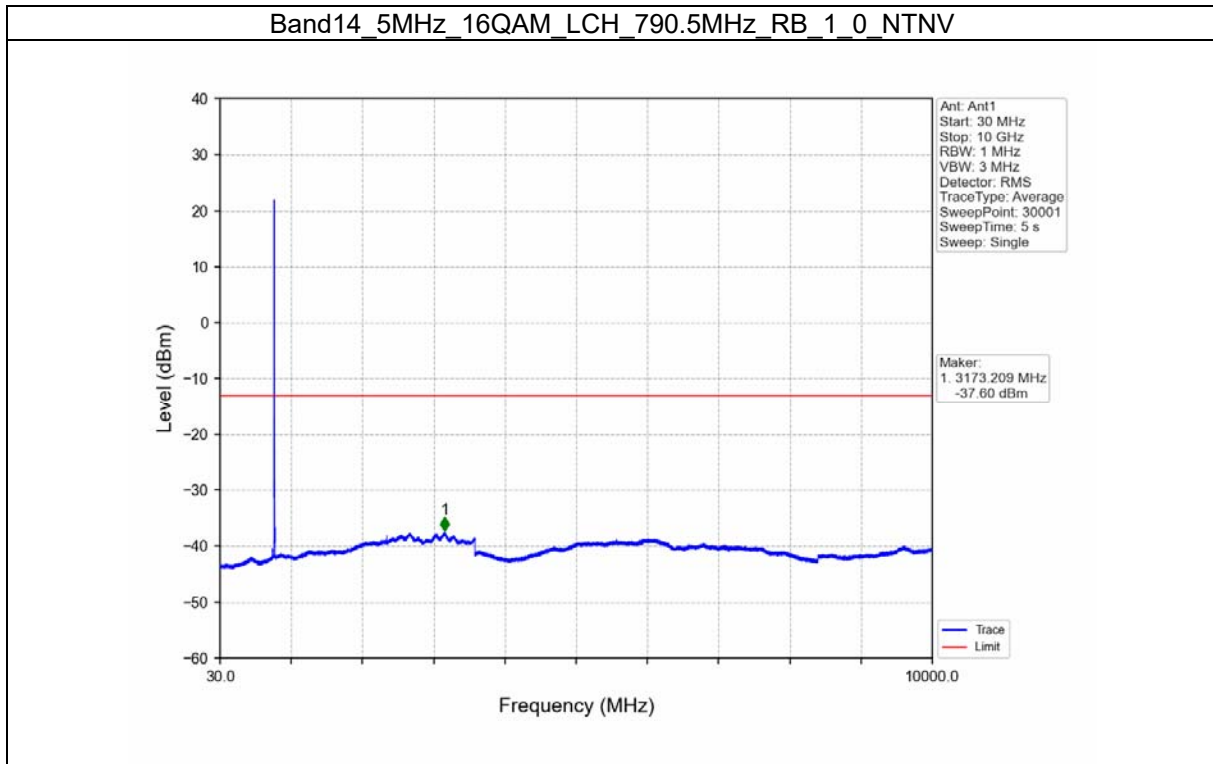

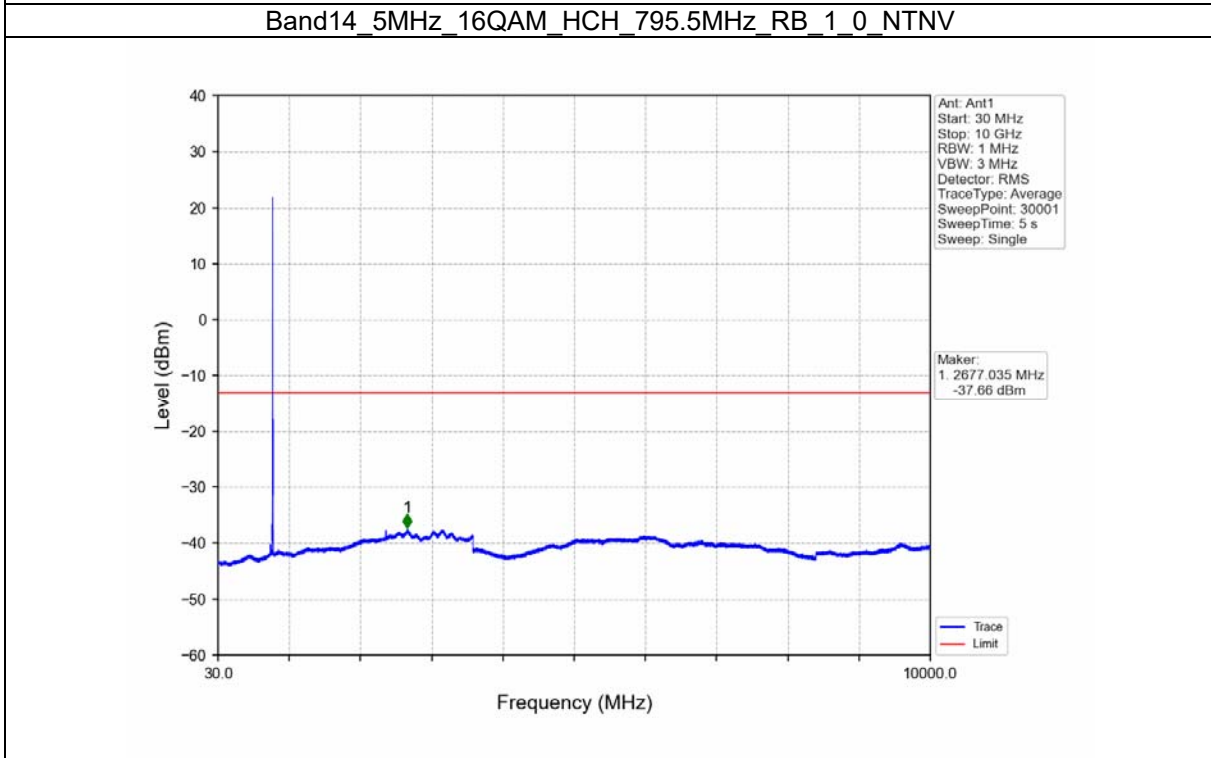
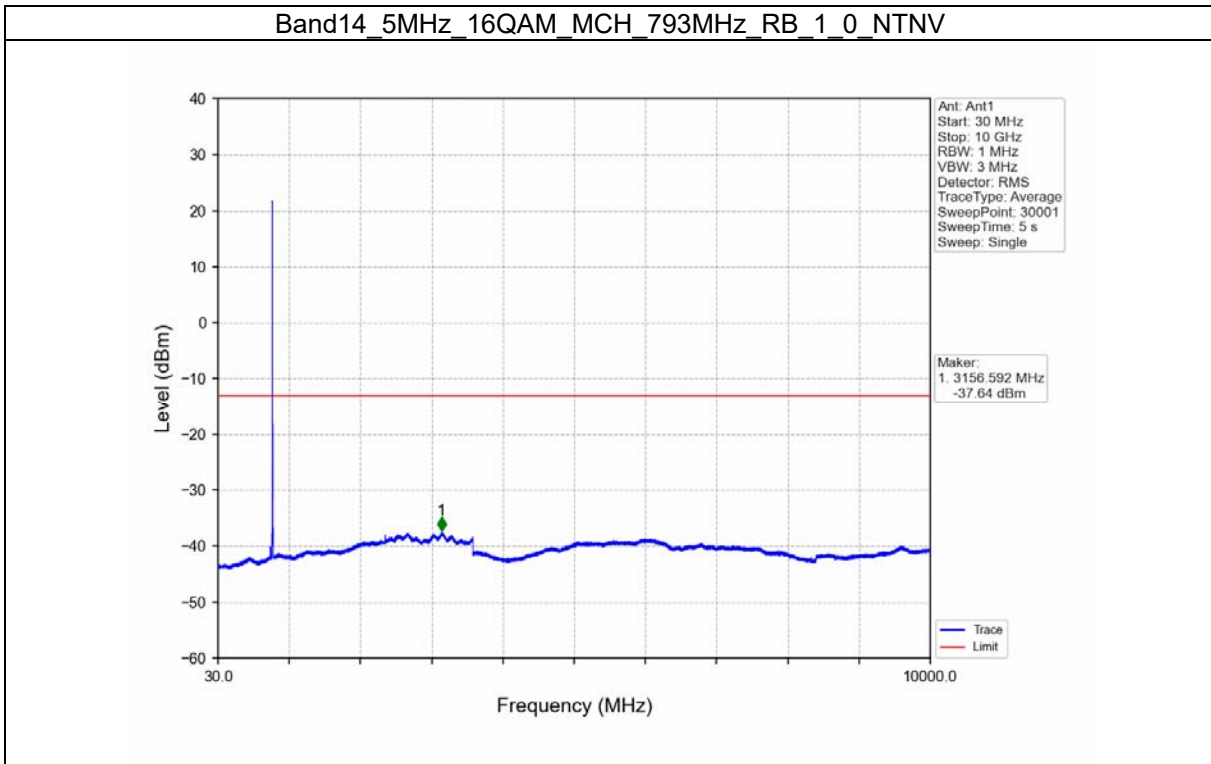

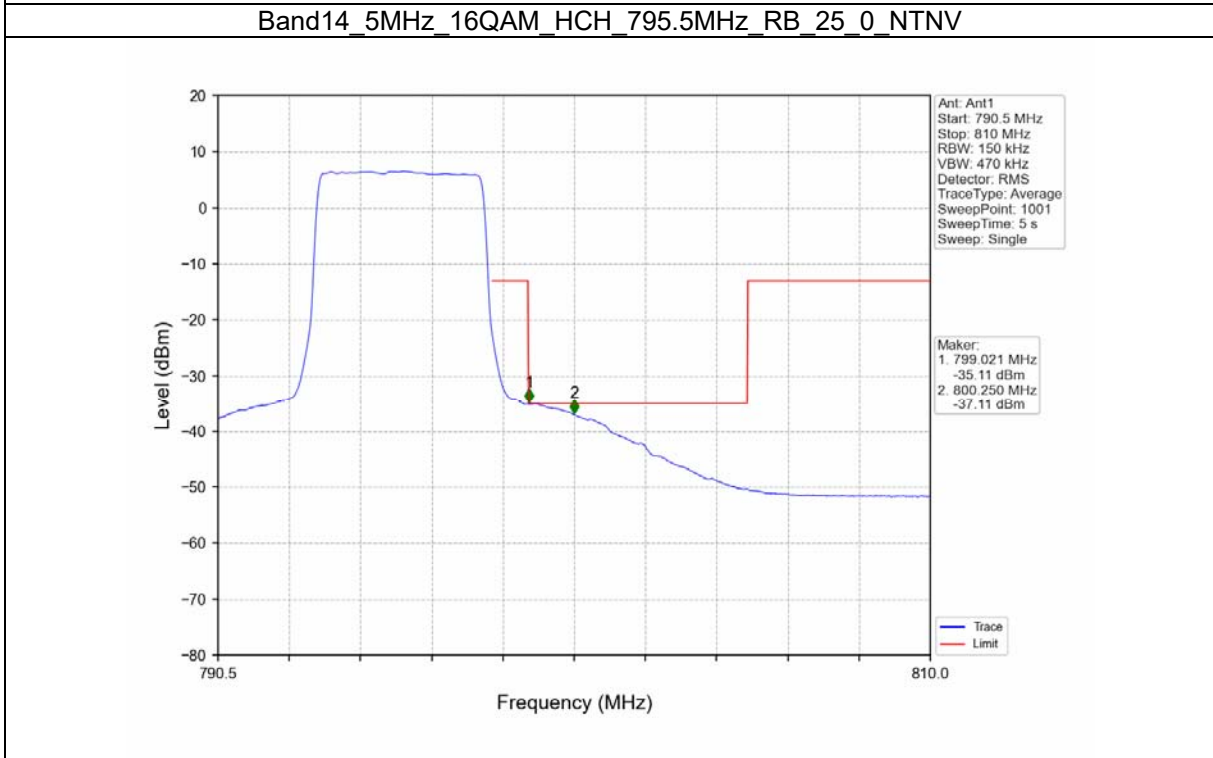
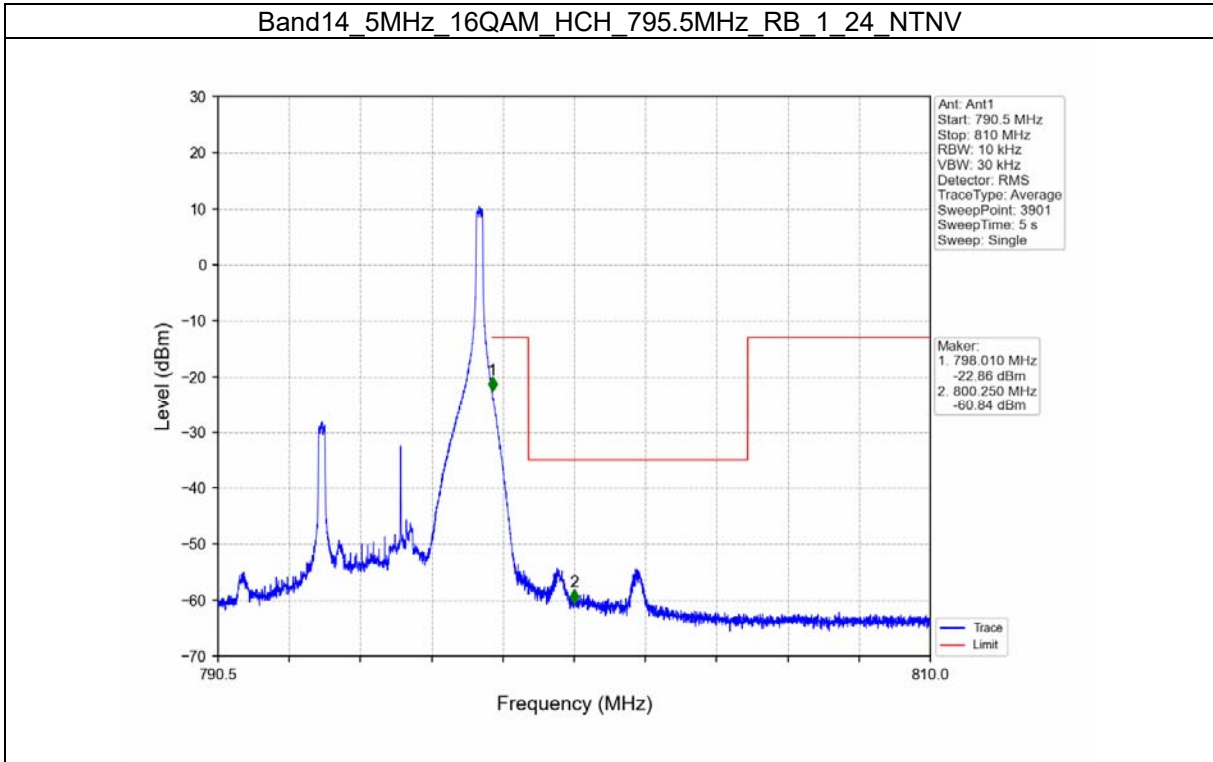

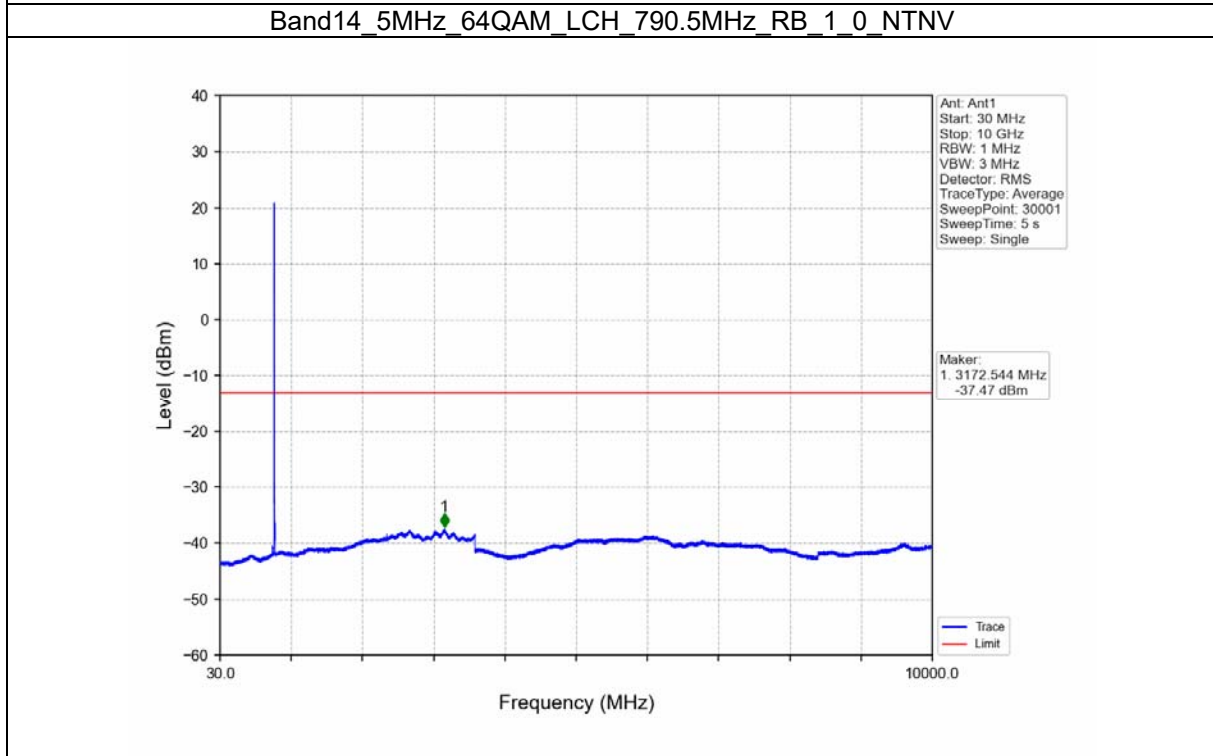
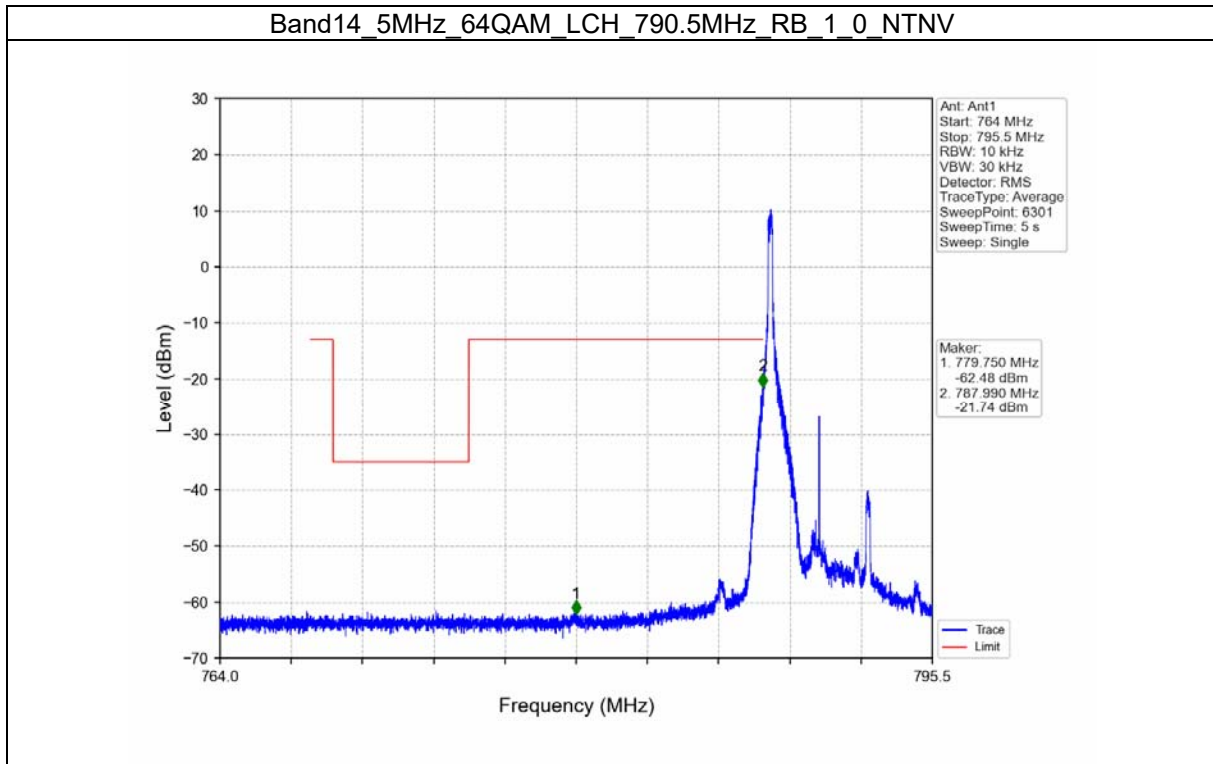

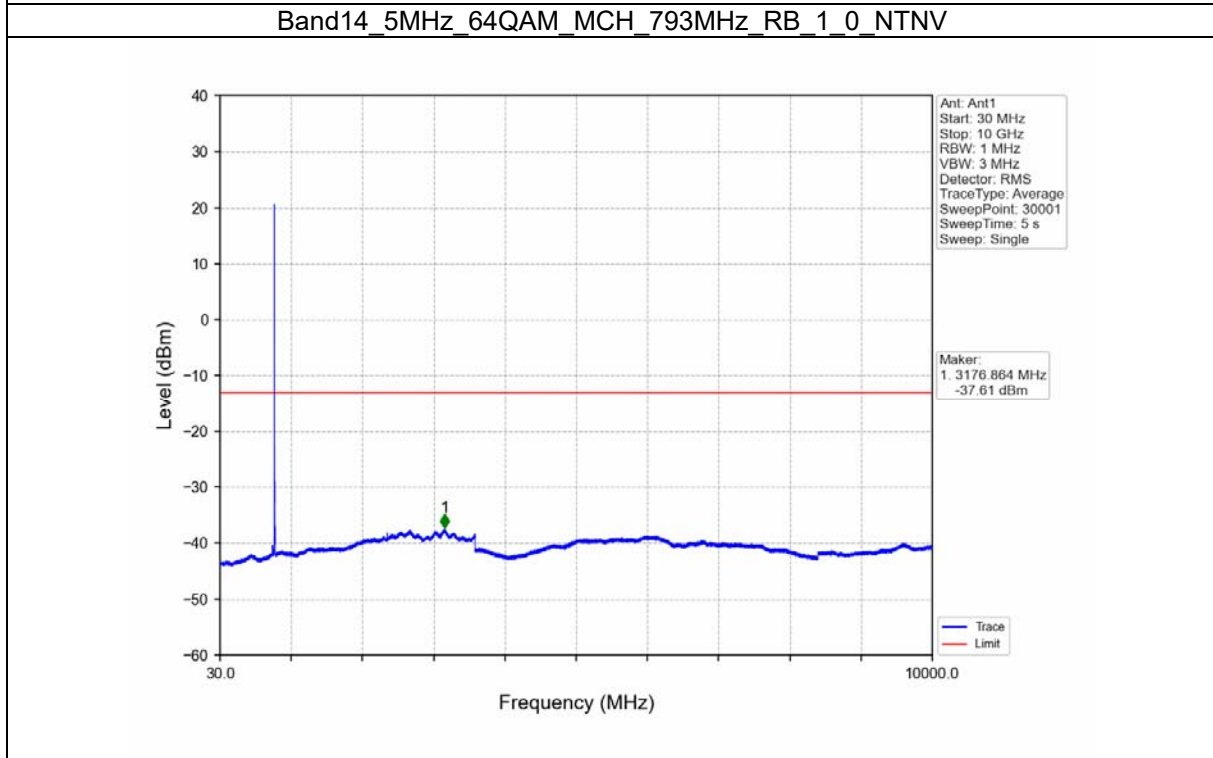
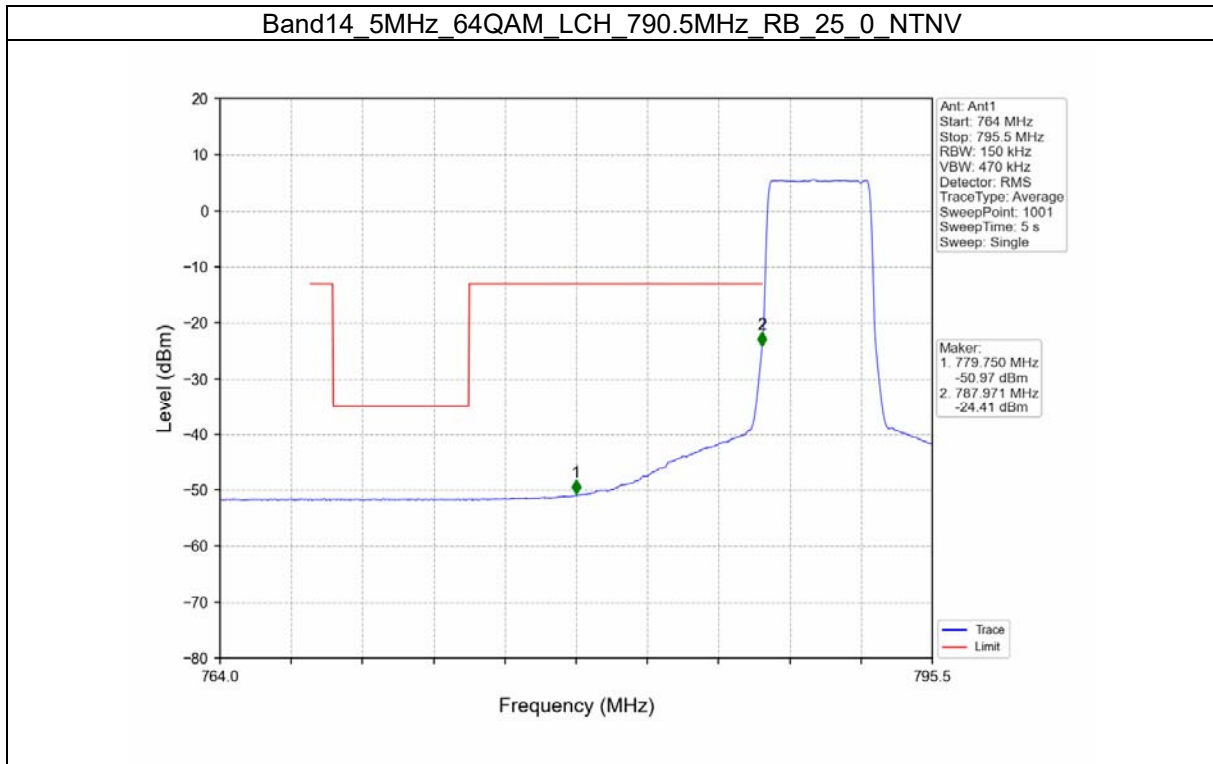

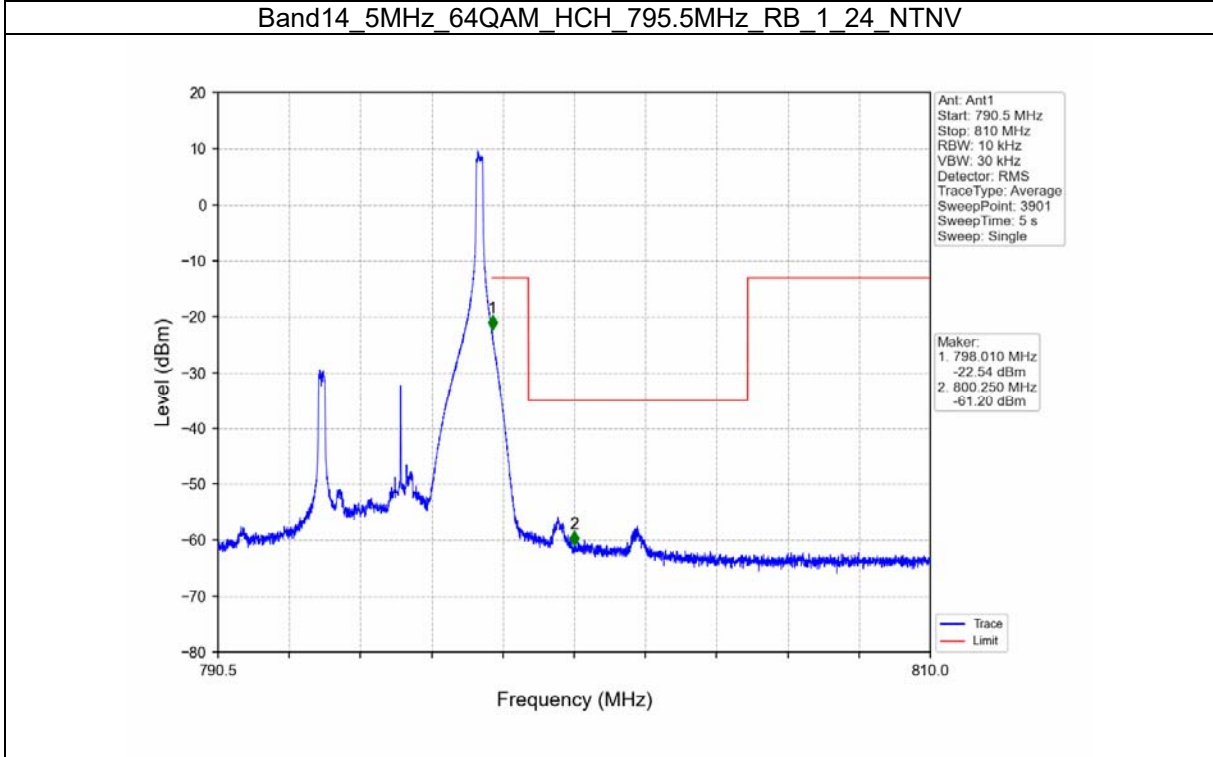
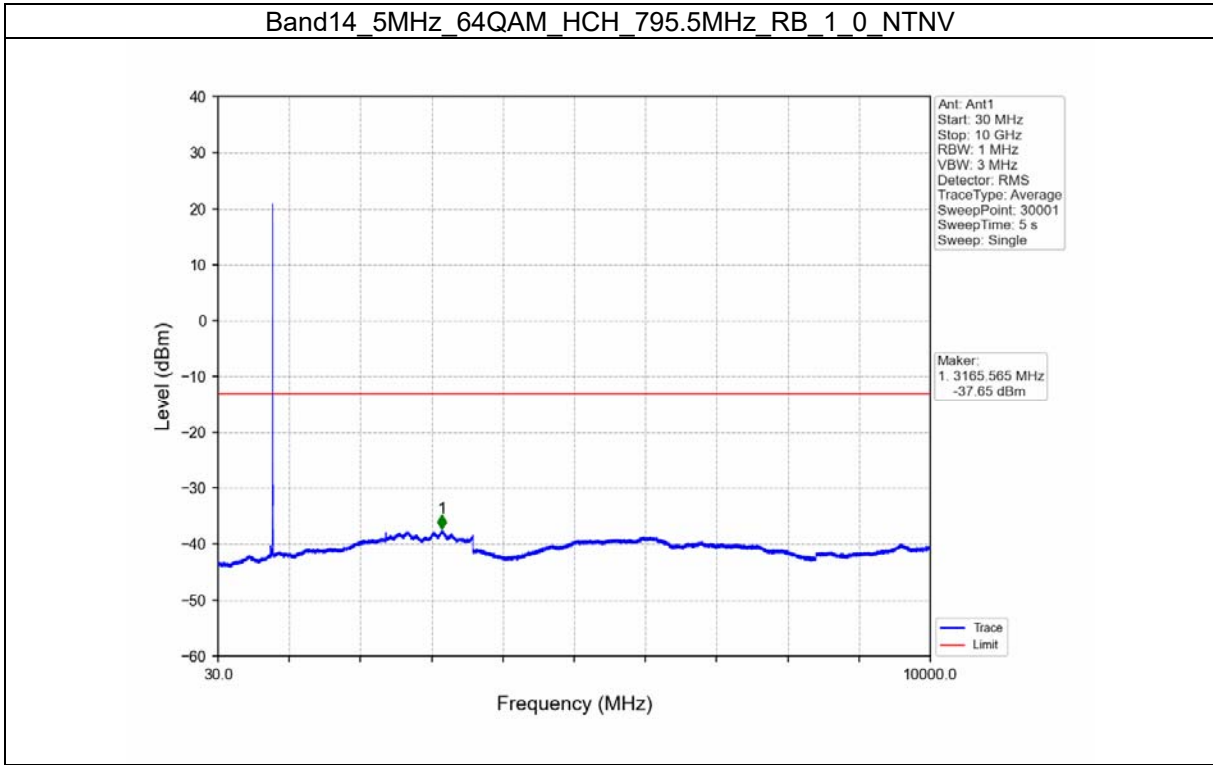



Test Report No.: W7L-220503W001RF07

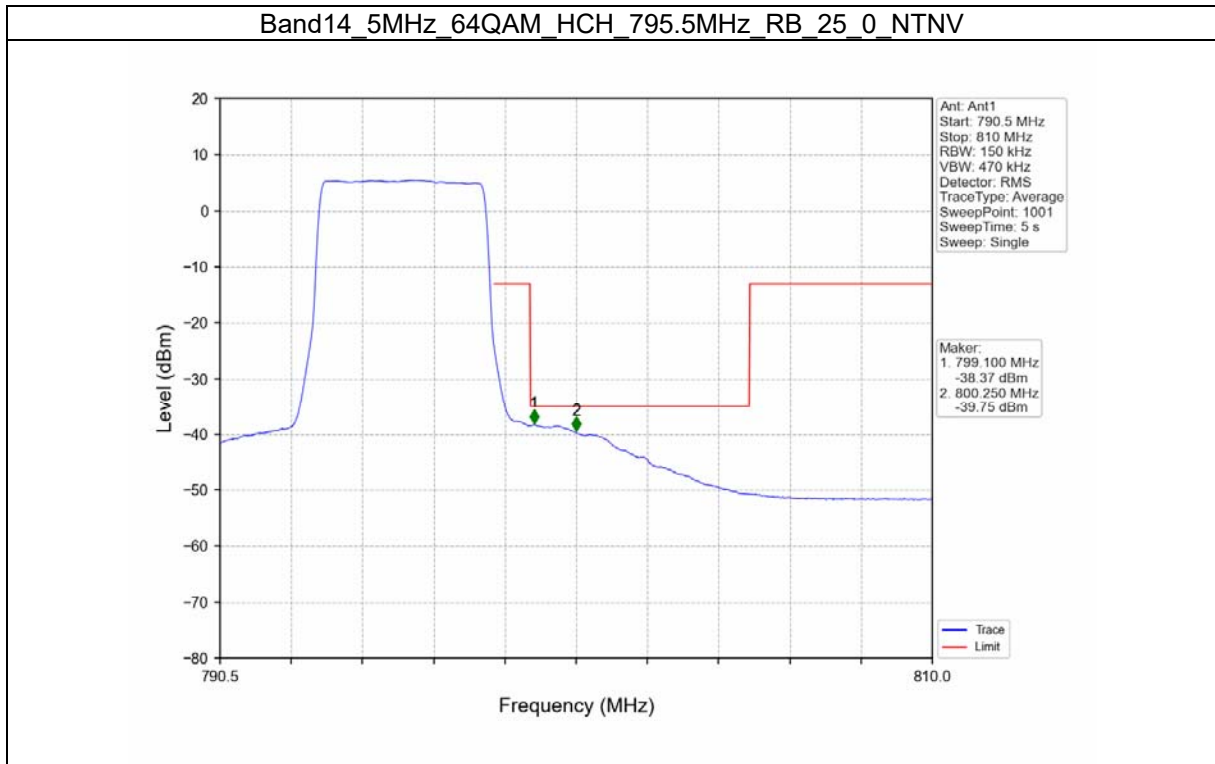



Test Report No.: W7L-220503W001RF07

B14_10MHz

Test Result

| Band: 14 / Bandwidth: 10MHz / NTN | | | | | | |
|-----------------------------------|-----------------|---------------|--------|---------------------|-------|---------|
| Modulation | Frequency (MHz) | RB Allocation | | Spurious Emission | | Verdict |
| | | Size | Offset | Result | Limit | |
| QPSK | 793 | 1 | 0 | Refer To Test Graph | | Pass |
| | | | 49 | Refer To Test Graph | | Pass |
| | | 50 | 0 | Refer To Test Graph | | Pass |
| 16QAM | 793 | 1 | 0 | Refer To Test Graph | | Pass |
| | | | 49 | Refer To Test Graph | | Pass |
| | | 50 | 0 | Refer To Test Graph | | Pass |
| 64QAM | 793 | 1 | 0 | Refer To Test Graph | | Pass |
| | | | 49 | Refer To Test Graph | | Pass |
| | | 50 | 0 | Refer To Test Graph | | Pass |

Test Graph

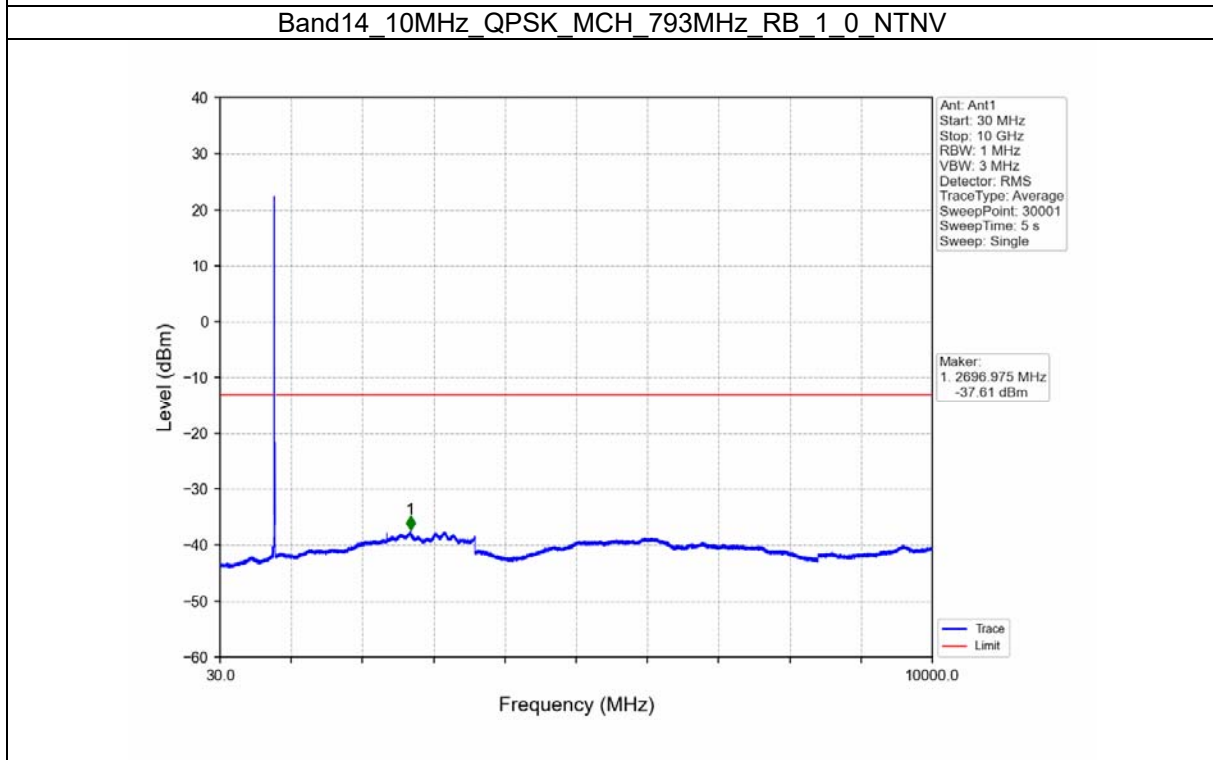
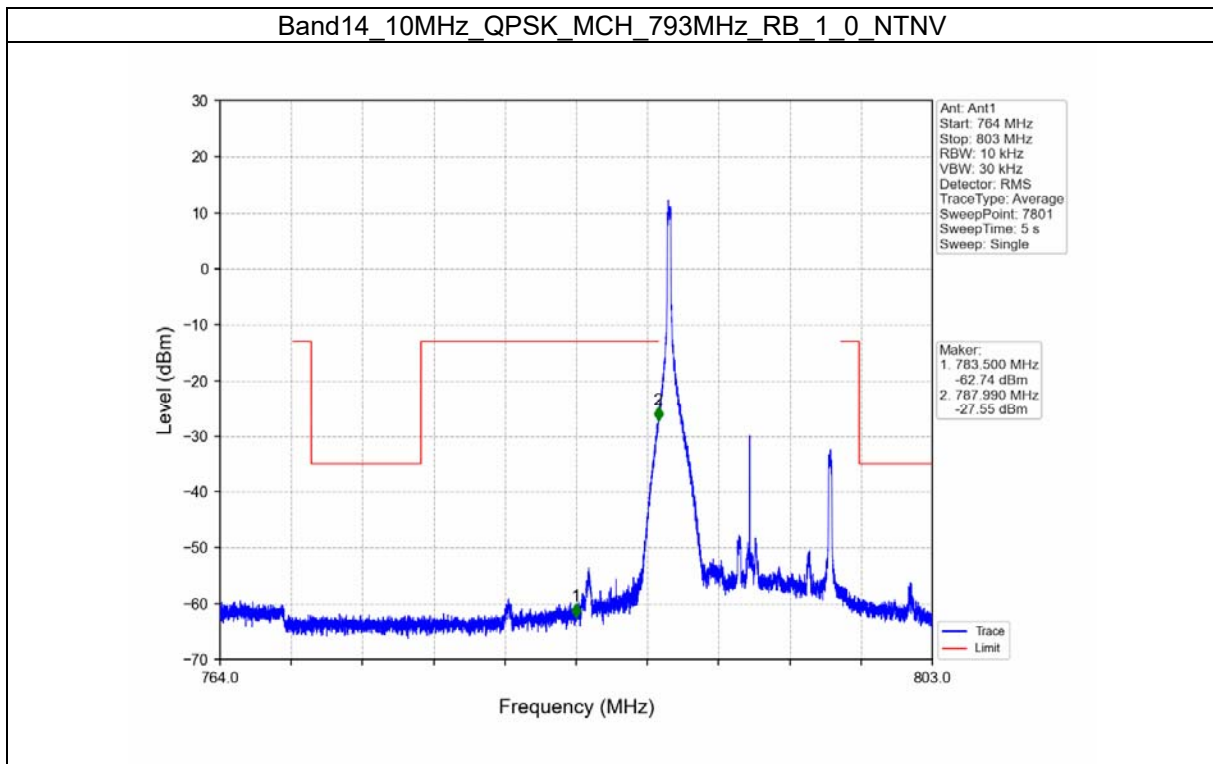



Test Report No.: W7L-220503W001RF07

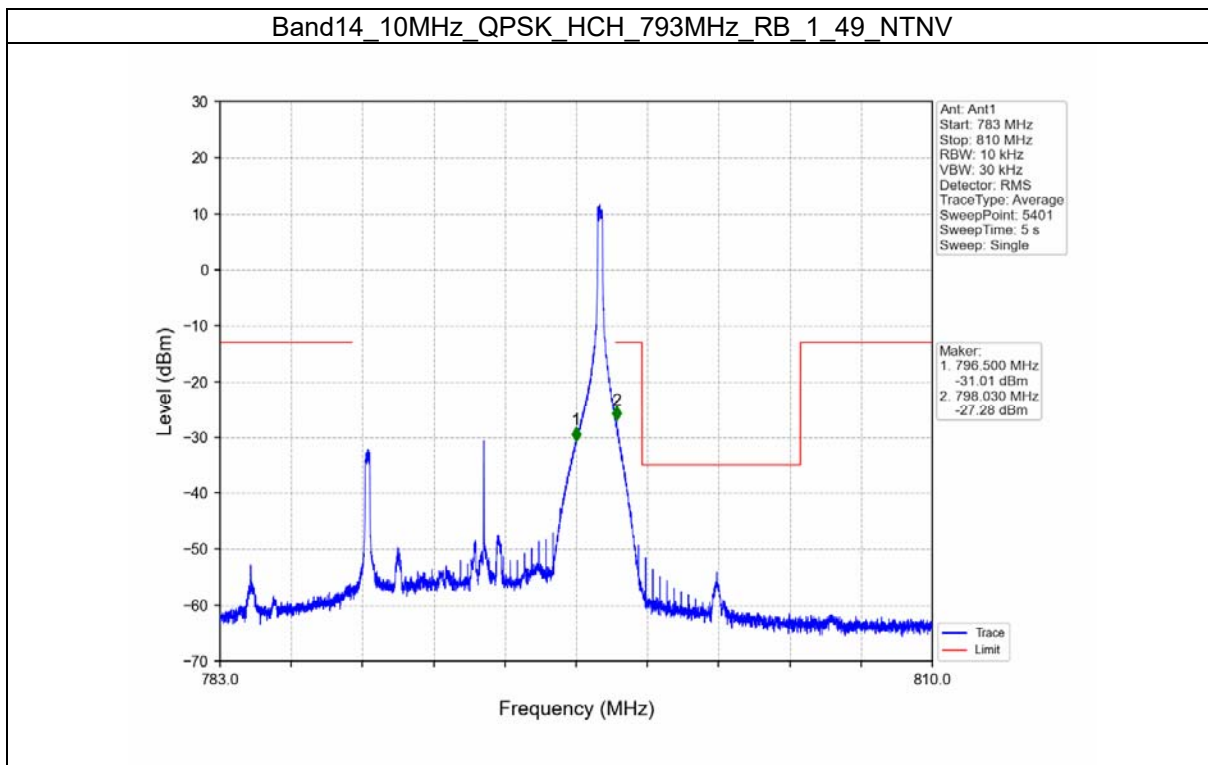



Test Report No.: W7L-220503W001RF07

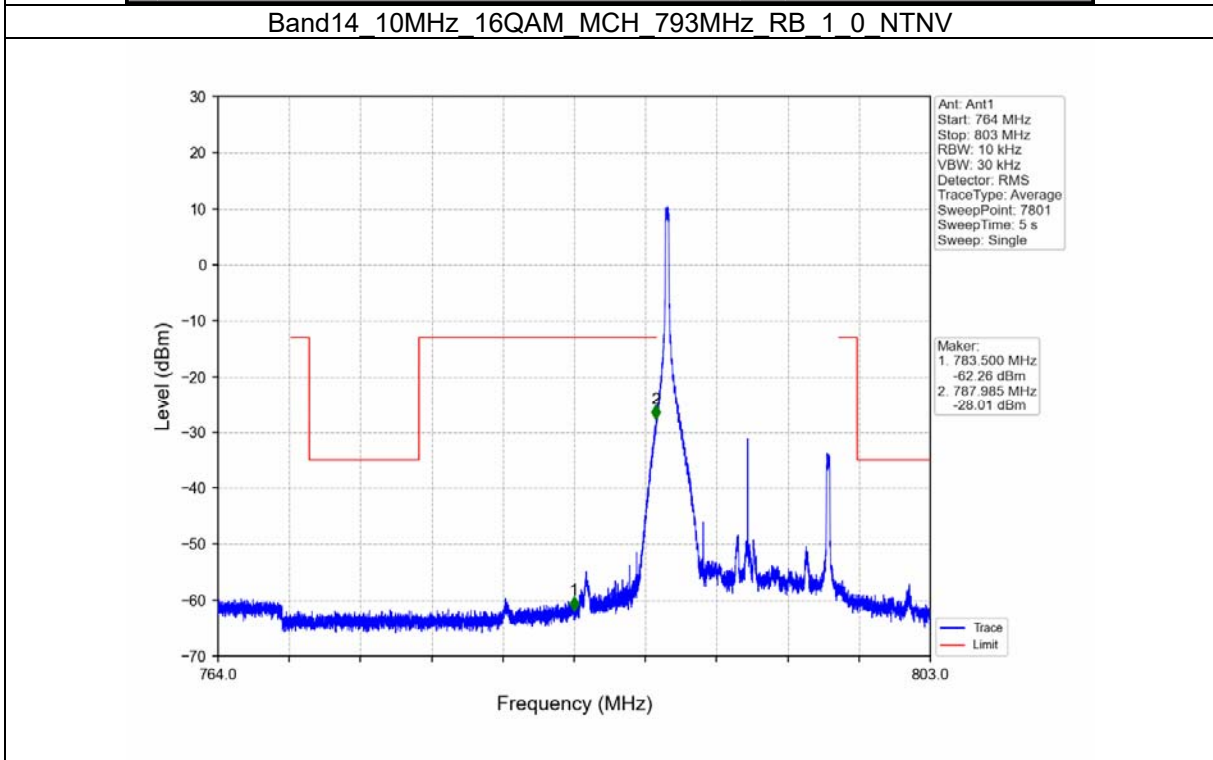
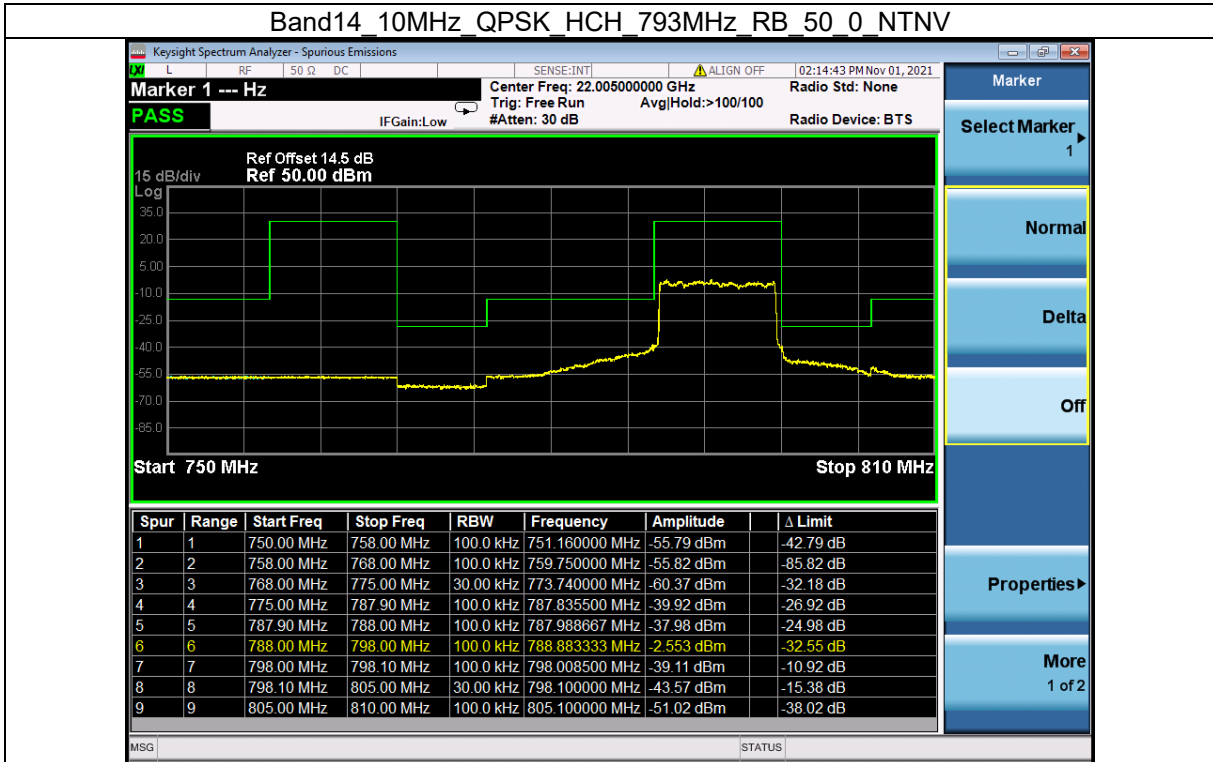



Test Report No.: W7L-220503W001RF07

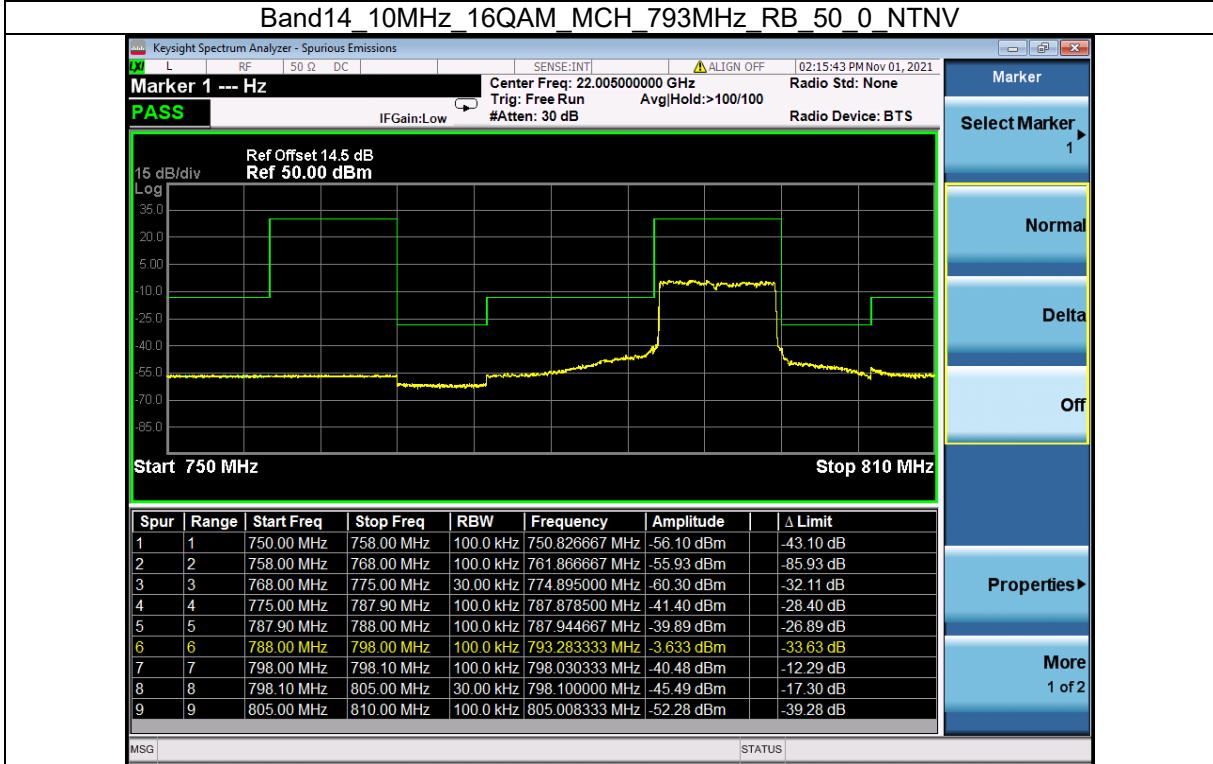
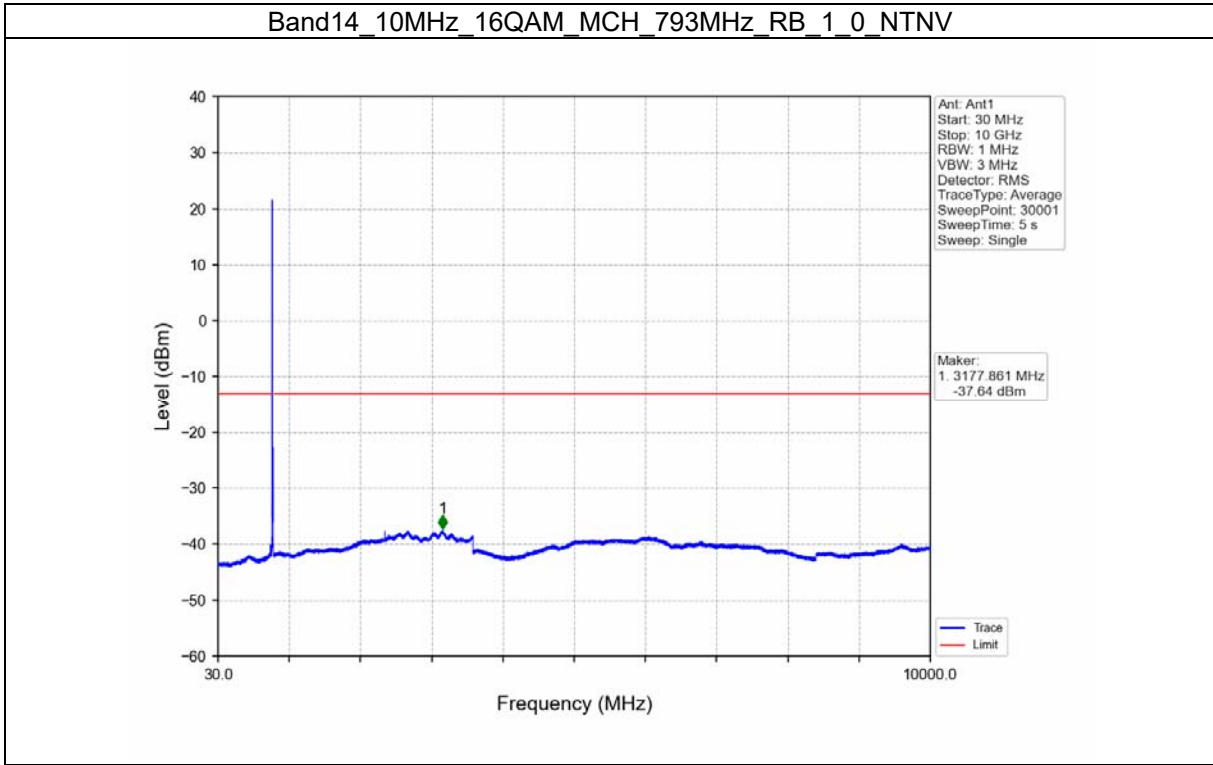



Test Report No.: W7L-220503W001RF07

