



INSTRUCTIONS FOR USE AND CARE

Safety Information

Please read this manual carefully before using the product.

keep it in a safe place for future reference.

- a.** There are high voltage zones inside this unit that can cause injuries. Please do not open the unit. In case of technical failure, please contact the authorized service centre.
- b.** Never place the unit in the rain or in moist zones so as to avoid a fire or an electric shock.
- c.** This device uses a laser system. To prevent direct exposure to the laser beam, please do not open the unit or stare at the laser beam.
- d.** If technical maintenance is required, please contact the authorized service centre.
- e.** If the supply cord is damaged in any way, please have it replaced by the manufacturer, supplier or a qualified electrician.

Caution

- a. Do not place the unit on an unstable surface as it may fall and break or cause damage to people or pets.
- b. Disconnect the unit from the mains before cleaning it. Do not use cleaning liquids or sprays. Use only a soft, damp cloth.
- c. To avoid possible damage to the equipment, please unplug it during storms or when it will not be used for a long time.
- d. Do not insert any object into the unit through the ventilation openings as this could cause a short circuit and start a fire. Do not pour liquid on the speaker.

Accessories

- Speaker unit
- User Manual
- Remote Control
- Adaptor

INTRODUCTION-TOP CONTROLLING PANEL

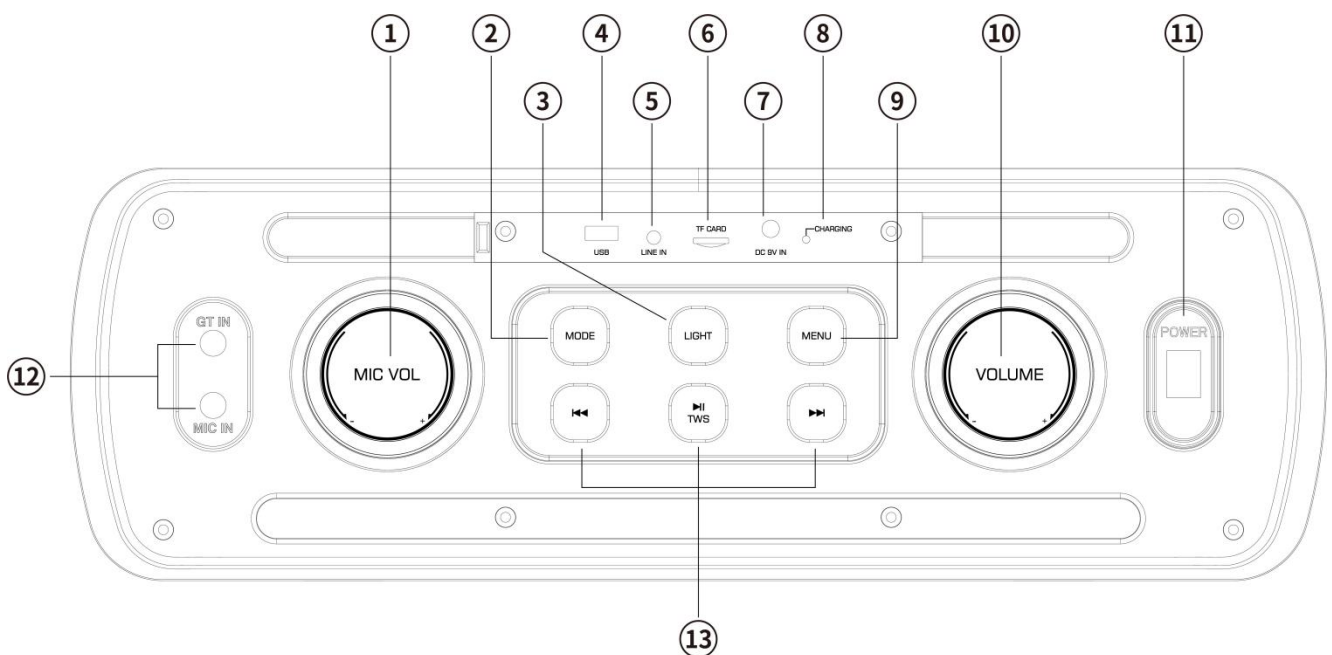

INTRODUCTION-TOP CONTROLLING PANEL

1. **Mic Volume+/-**
2. **.Mode** :Press to select the following modes: LINE (Aux-In)/USB/card/FM/Wireless BT
3. **Light mode switching and on/off**,short switch to get different mode,long press to on/off the light.
4. **UBS Input** :Insert USB to play.
5. **Line in(3.5mm)**
6. **TF Card Input**:Insert TF card to play.
7. **DC 9V input**(charging slot)
8. **Charging indicator**
9. **MENU**: control BASS/Treble/MIC Volume
10. **Main Volume+/-**
11. **Power switch**
12. **Microphone input/Guitar input**
13. **Previous sound (under USB/TF/BT mode)**
Next sound (under USB/TF/BT mode)
14. **Short press to pause & play, long press to get TWS function (under 2 pieces)**

TWS (True Wireless Stereo)method of use :

1. Power on 2 speakers, both switch to “Bluetooth Mode”;
2. Long Press “ PLAY/PAUSE button  for one unit(as the deputy model), when under successful connection , LCD Display of the deputy model show“ BLUE” without flicker.
3. Use your BT device to connect another unit (as the host model), when under successful connection , LCD Display of the host model show“ BLUE” without flicker.
4. Under TWS mode, you can adjust the main volume/play/pause/next song/previous song to control the 2 speakers at the same time.
5. If to disconnect TWS, short press “ TWS” on the host or deputy model.

INTRODUCTION-REMOTE CONTROL

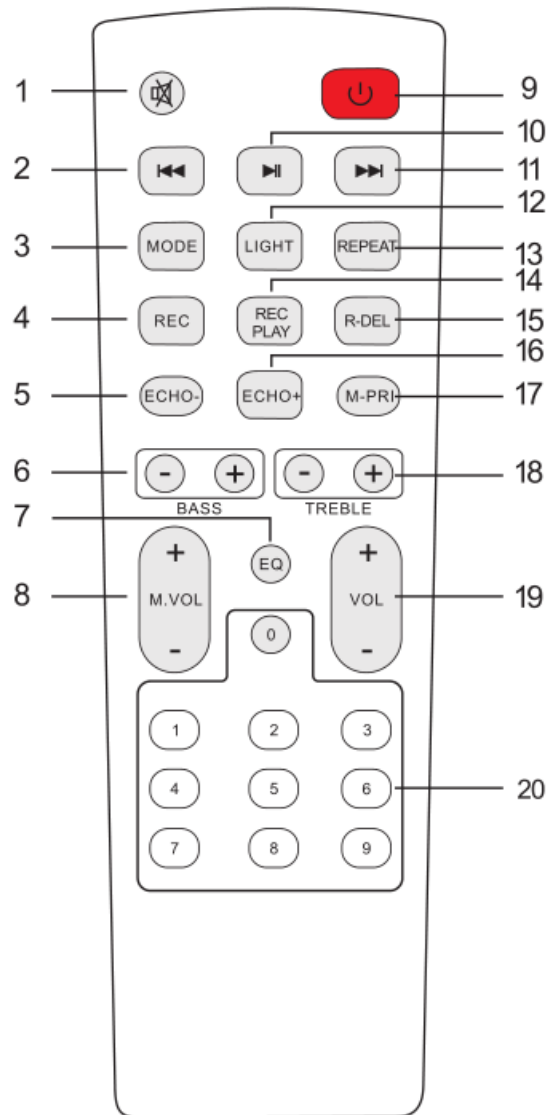

1.Mute

Available to be mute at any mode

2.Previous Song/station

Under USB/TF card mode - previous song.

Under BT connection mode- previous song.

Under FM mode- previous station.

3.Mode

Press shortly to skip to Wireless BT/LINE IN/USB/TF/FM mode.

4.Record function

Under USB/TF card mode,press "REC" button to record

5.Echo-

6.BASS+/-

7.EQ function

8.Microphone Volume+/-

9.Stand by

10.Pause&Play

11.Next song/station

Under USB/TF card mode - next song.

Under BT connection mode- next song.

Under FM mode- nextstation.

12.Light mode

13.Repeat function

14.Record play

15.Record delete

16.Echo+

17.Microphone priority

18.Treble+/-

19.Main Volume+/-

20.Number buttons



Under USB/TF mode to choose songs

OPERATING INSTRUCTIONS

● **Wireless BT Pairing Mode:**

Press MODE or Blue button on the unit or the remote control until BT is selected.

1. Put the cell phone within 20 meters;
2. Activate the BT features on your cell phone so that the cell phone starts to search for the BT device. Please refer to the users' manual for details
3. Select the correct model No. (IQ-2065) from the device found by the cell phone;

4. Shortly press PLAY/PAUSE button  to play or pause music. Short press " " or " " key to select the previous or next track.

● **LINE IN MODE:**

Press MODE button on the unit or the remote control until LINE is selected. Play the music of the device connected to the LINE input.

● **USB Mode:**

1. After start up, press MODE to select "USB" and insert the USB device. The unit will automatically read and play the music in the USB device.

2. Press “” key shortly to pause or play.

3. Shortly press “” key to the previous song.

4. Shortly press “” key to the next song.

FCC Warning Statement

Changes or modifications not expressly approved by the party responsible for compliance could void the user's authority to operate the equipment. This equipment has been tested and found to comply with the limits for a Class B digital device, pursuant to Part 15 of the FCC Rules. These limits are designed to provide reasonable protection against harmful interference in a residential installation. This equipment generates uses and can radiate radio frequency energy and, if not installed and used in accordance with the instructions, may cause harmful interference to radio communications. However, there is no guarantee that interference will not occur in a particular installation. If this equipment does cause harmful interference to radio or television reception, which can be determined by turning the equipment off and on, the user is encouraged to try to correct the interference by one or more of the following measures:

- - Reorient or relocate the receiving antenna.
- - Increase the separation between the equipment and receiver.
- - Connect the equipment into an outlet on a circuit different from that to which the receiver is connected.
- - Consult the dealer or an experienced radio/TV technician for help.

This device complies with part 15 of the FCC Rules. Operation is subject to the following two conditions: (1) This device may not cause harmful interference, and (2) this device must accept any interference received, including interference that may cause undesired operation.

RF Exposure Statement

To maintain compliance with FCC's RF Exposure guidelines, This equipment should be installed and operated with minimum distance of 20 cm the radiator your body. This device and its antenna(s) must not be co-located or operation in conjunction with any other antenna or transmitter.