

User Manual

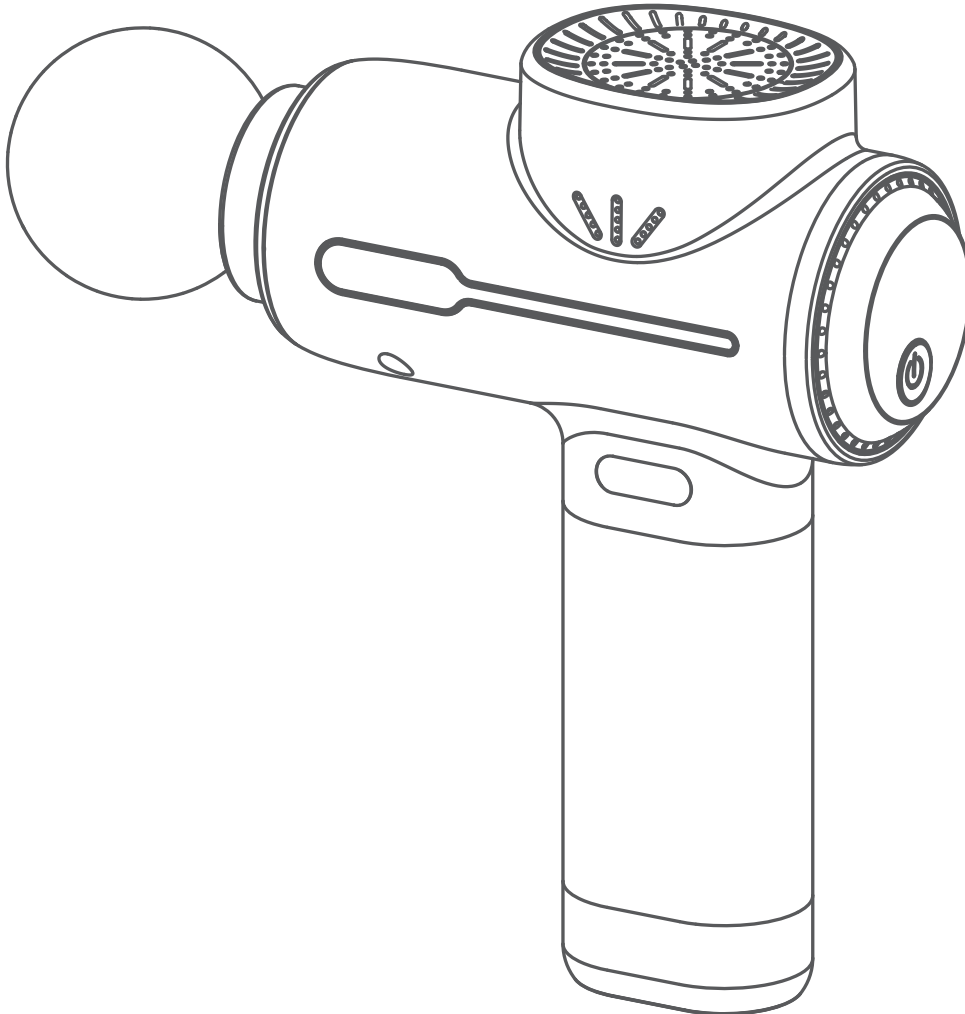

Model number:R-C002S, R-C002SH

Massage Gun

IMPORTANT SAFETY INSTRUCTIONS

When using this device, basic precautions should be always followed, including the following:

READ ALL INSTRUCTIONS CAREFULLY BEFORE USING.

Please consult your doctor before using if you are any of the following:

- 1) Pregnant or postpartum women
 - 2) Persons with blood stasis, fractures, or heavy inflammatory injuries
 - 3) Persons with hypertension (high blood pressure), severe varicose veins, or other conditions that affect the blood vessels
 - 4) Persons with heart disease, with a pacemaker, defibrillator, or metal contents in the body
 - 5) Persons recovering from joint surgery
- If you feel unwell or have any unusual discomfort, please stop using the device immediately.

CAUTION

1. The device is intended for household use only and not for medical purpose.
2. This device can be used by children aged from 8 years and above and by persons with reduced physical, sensory or cognitive capabilities or lack of experience and knowledge if they have been given supervision or instructions concerning the use of the device in a safe way and understand the hazards involved.
3. Children should not play with the device. Cleaning and user maintenance should not be made by children.

DANGER - To reduce the risk of electric shock:

1. DO NOT use while bathing or in a shower.
2. DO NOT place or store the device in the areas where it may

fall or be pulled into a tub or sink. DO NOT place in or drop into water or other liquid.

WARNING - To reduce the risk of fire, electric shock, or injury to persons:

1. Use this device only for its intended use as described in this manual. Do not use attachments not recommended by the manufacturer.
2. Close supervision is necessary when this device is used by, on or near children, invalids, and disabled persons.
3. DO NOT operate the device with the air openings blocked. Keep the air openings free of lint, hair, etc. Never drop or insert any object into any opening. Keep hair, loose clothing and fingers from air openings and moving parts.
4. DO NOT operate under a blanket or pillow. Excessive heating can occur and cause fire, electric shock, or injury to persons.
5. DO NOT operate in the areas where aerosol (spray) products are being used or where oxygen is being administered.
6. DO NOT keep the device near a magnetic field or in the areas where it can be affected by a magnetic field as this may cause batteries to discharge.
7. Keep the device away from heat and avoid using it in places where the surrounding temperature is relatively hot.
8. DO NOT attempt to disassemble or repair the device. Otherwise, it may cause damage and void the manufacturer's warranty.
9. DO NOT operate this device if it is not working properly, has been damaged, or dropped into water. Send the device to the service center for examination and repair.
10. Use the massage gun only on soft tissues. DO NOT use on your head, throat, tumor sites, possible fracture sites, or near your genitalia. Do not use on any open wounds or surgical incisions prior to stitches.

SAVE THESE INSTRUCTIONS

WHAT'S IN THE BOX

1 x Massage Gun
5 x Massage Head
1 x Type-C Charging Cable
2 x Rubber Sleeve
1 x Travel Case
1 x User Manual

SPECIFICATIONS

Product Name: **Massage Gun**
Model: **R-C002S, R-C002SH**
Input: 5V  2A
Rated Power: 25W
Amplitude: 9mm
RPM: 1800/2050/2300/2500/2800r/min
Auto-off Timer: 10mins
Battery Voltage: DC 7.4V
Battery Capacity: 2000mAh
Charging Time: $\leq 1.5\text{H}$
Working Time: about 3H
Noise: $\leq 55\text{dB}$
Product Dimensions: 7.3x5.7x2.3 inch/186x147x60mm
Product Weight: 1.5lb/676g
Environmental Conditions:
Temperature: 5 °C - 35°C
Relative Humidity: $\leq 90\%$;
Atmospheric Pressure: 70kPa-106kPa

PRODUCT OVERVIEW

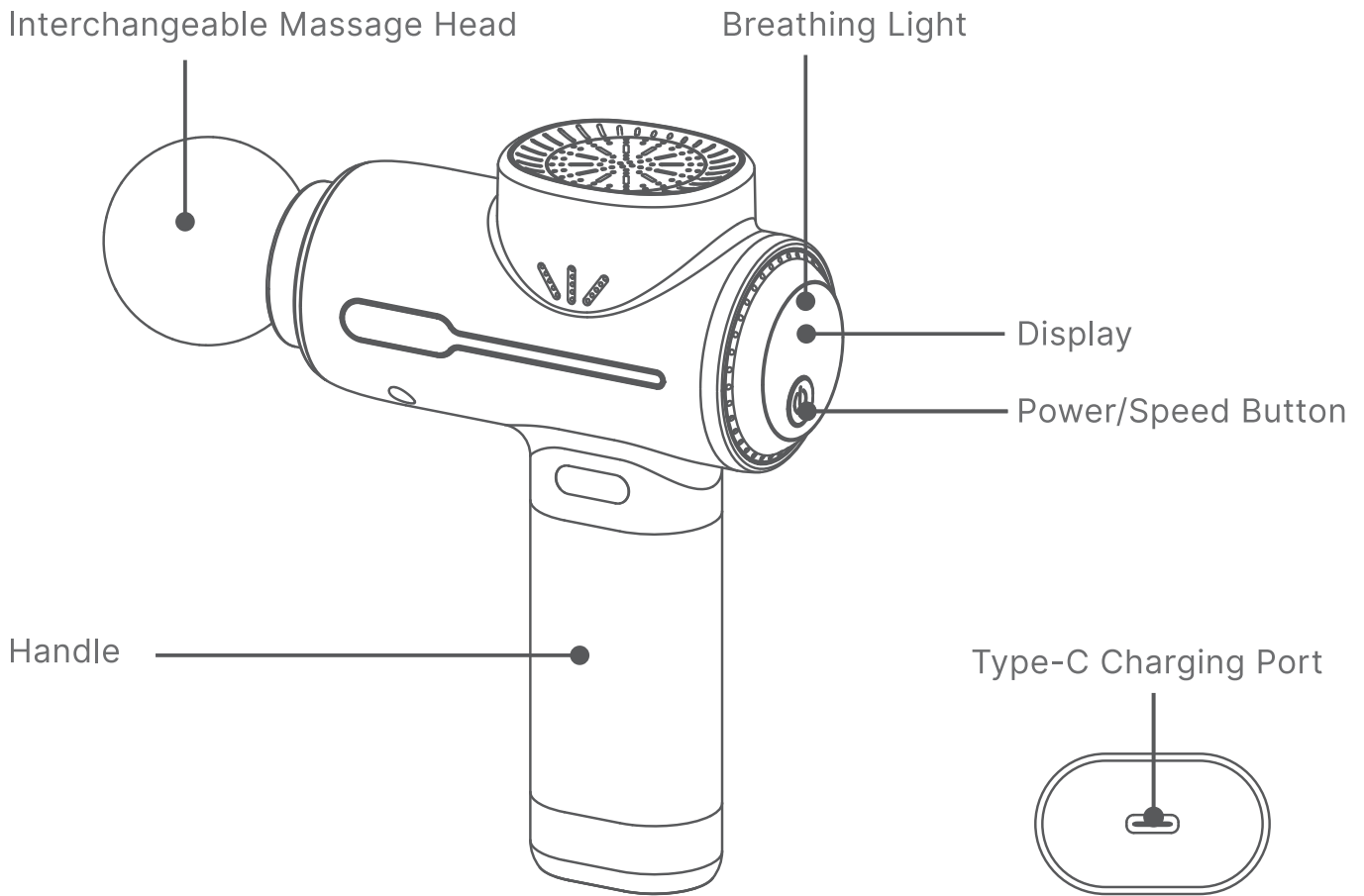

MASSAGE HEAD ATTACHMENTS

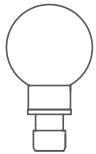

Ball head

For large muscle groups like quads, glutes, extreme muscles, and joint soreness.

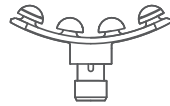

Crescent head

For superficial muscles like brachioradialis and extensor digitorum.

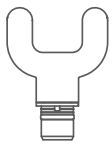

U-shaped head

For spine, neck and Achilles tendon.



Annular head

For muscle groups with a certain radius like iliotibial tract, adductor magnus and Gluteus maximus.



Bullet head

For joints, deep tissues, trigger points and small muscle areas like feet and wrist.



Rubber Sleeve

Each massage head is pre-installed with a rubber sleeve. If it is damaged, replace with a spare one.

CHARGING

Fully charge the device before using it for the first time.

To charge, plug the provided Type-C charging cable to the unit's charging interface and into the mobile power source or mobile charger (not included). Ensure the input should be DC 5V, 1A/2A.

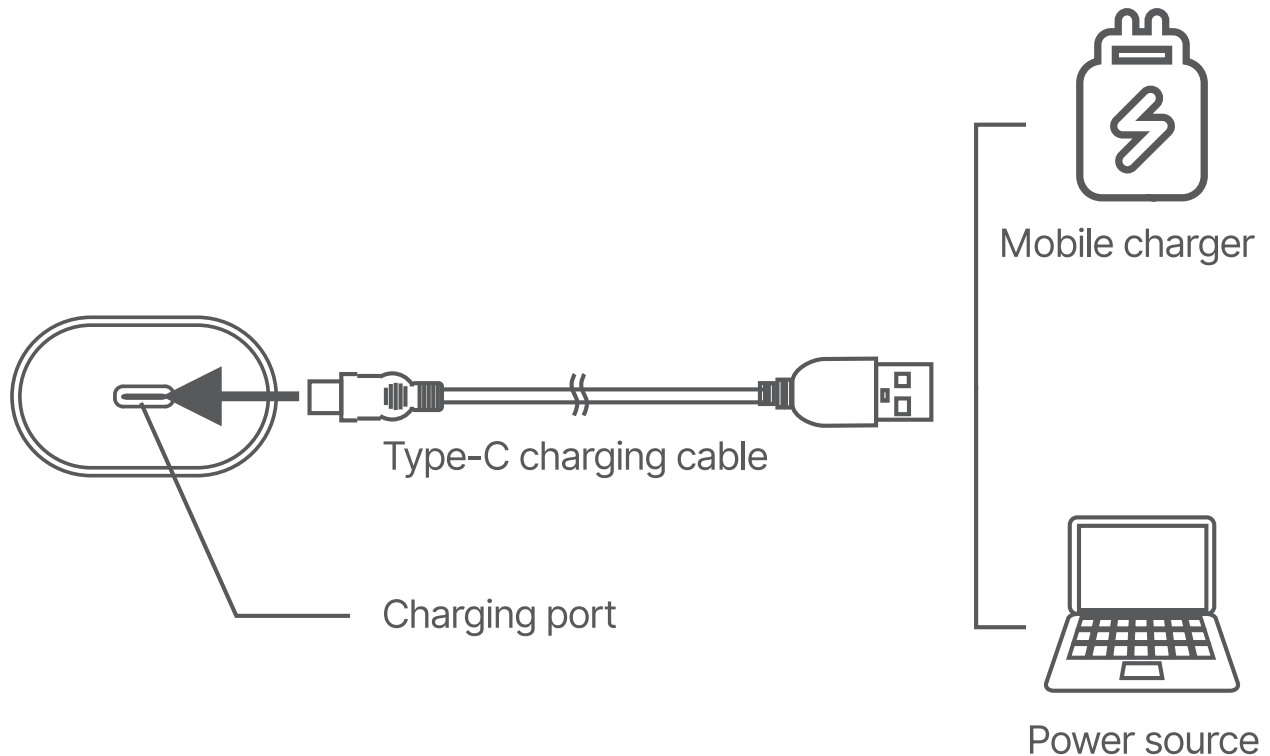

Status	Display
Low battery	Flashes red "⚡".
Normal charging	Shows current battery level
Fast charging	Shows "⚡" and current battery level

Note: The device cannot be turned on while charging.



ATTACHING THE MASSAGE HEAD

Select the desired massage head and connect to the device properly by fully inserting the joint into the slot. Ensure the device is turned off when switching the massage head.

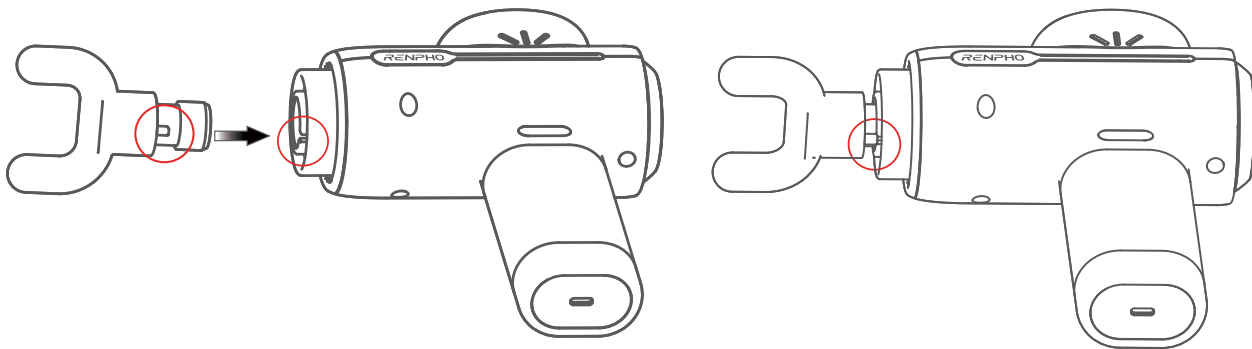
Note: The installation of the U-shaped head should be positioned. When the buckle is inserted into the slot, it means the installation is in place. Otherwise, there will be a risk of falling off while in use.



USING THE PRODUCT

- Press and hold "  " for 2s to turn on the device. The indicator light will turn on and the display will show the current battery level and then "L0".
- After power on, short press "  " to cycle through speed levels: L1/L2/L3/L4/L5 (RPM: 1800/2050/2300/2500/2800r/min).
- Press and hold "  " for 2s again to turn off the device. The indicator light and the display will turn off.

Note:

- The device will enter standby status if left idle for 120s after power on.
- Auto-off function: The device shuts off automatically after 10 minutes of continuous use.
- Locked-motor protection: If you apply excessive pressure on the device during your session, the device will stall to prevent injury or bruising.
- It is recommended to start every massage session with minimal intensity before you get used to it. Do not use for more than 30 minutes at a time.

Breathing Light Instructions

Status	Breathing Light
Normal operation	Blue
A little much pressure applied	Orange
Stall warning: Excessive pressure applied	Red
Charging	Flashes green slowly when battery level \geq 20%
	Flashes red slowly when battery level $<$ 20%
Fully charged	Off

APP GUIDE

Step 1: Download the App

Search and download the "Renpho Health" App from Apple App Store / Google Play or scan the QR code to download the Renpho Health App.

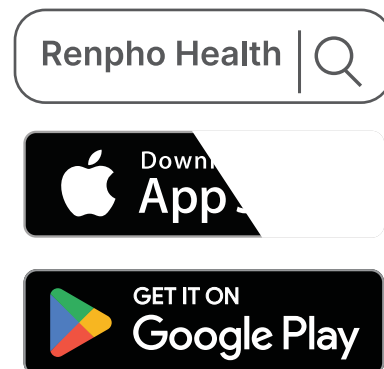

Note: Due to continuous updates and improvements, the "Renpho Health" App may appear slightly different.

Step 2: Log in/Sign up

- Log in directly with an existing RENPHO App account.
- If you don't have any RENPHO App account, tap "Sign up". Register a new account of Renpho Health App using your email address and complete your profile information.

Step 3: Add Device

* Enable Bluetooth on your smartphone before adding the device.

- Method 1:

- Press and hold the Power button for 2s to turn on the device.
- A window will pop up on the phone screen and tap "Connect".

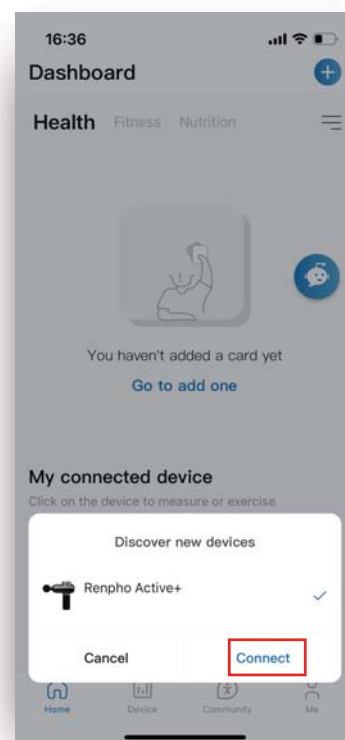

- Method 2:

- a. Tap "+" on the top right corner of the "Home" page to pair manually.
- b. Select "**Massage**" and tap "**Massage gun**".
- c. A window will pop up on the phone screen and tap "+".

Note: If the device is connected to the App and left idle, it will automatically shut down in 2 minutes.

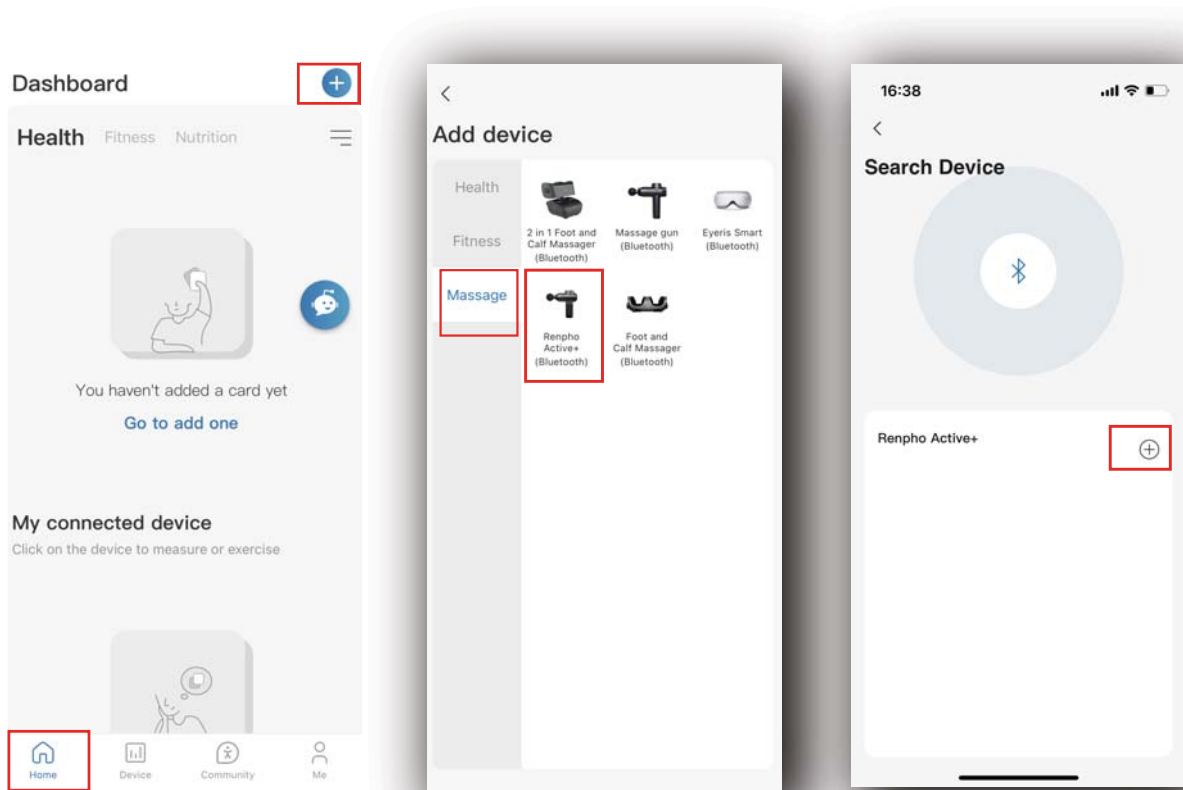

Step 4: Massage

- Method 1: Massage in free mode

- After a successful connection, you will enter the "Free mode" page.
- If you choose "Manual" mode (Default), you can choose the speed levels among level 1-5 manually to get your personalized massage.
- If you choose "Auto" mode, the device will automatically increase the speed by 1 gear every 30 seconds. Tap  to reset the time.

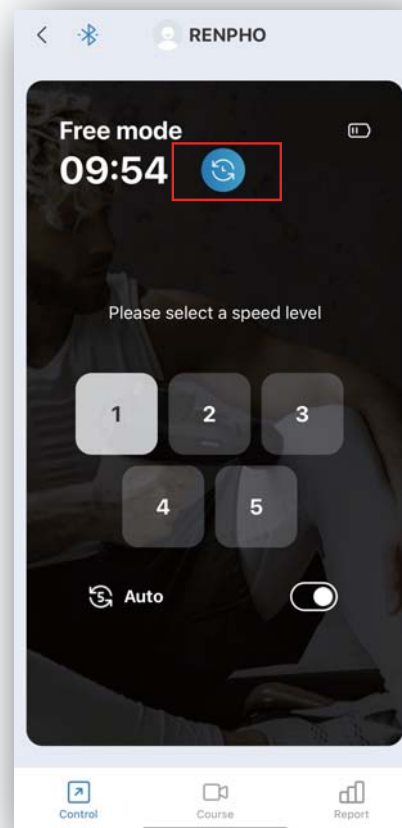
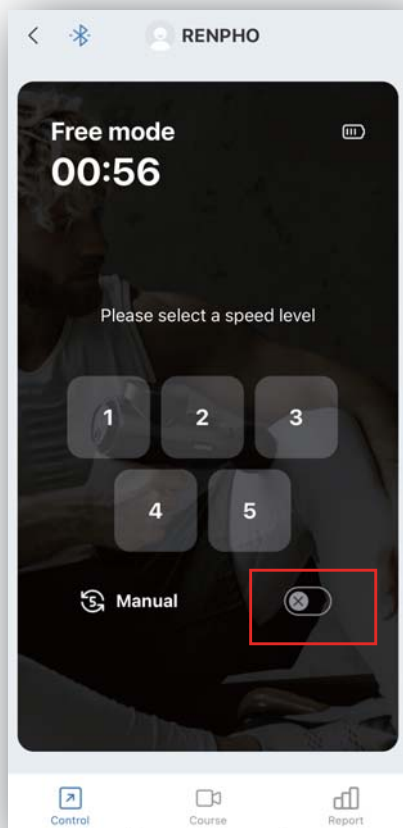



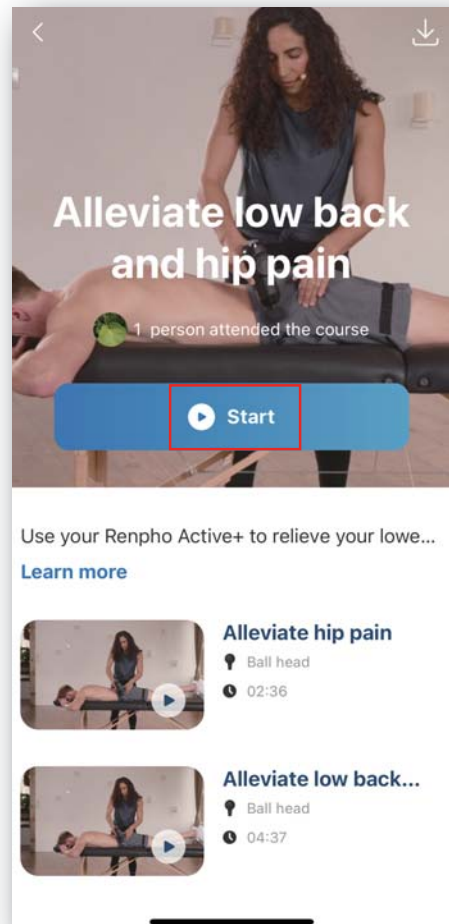
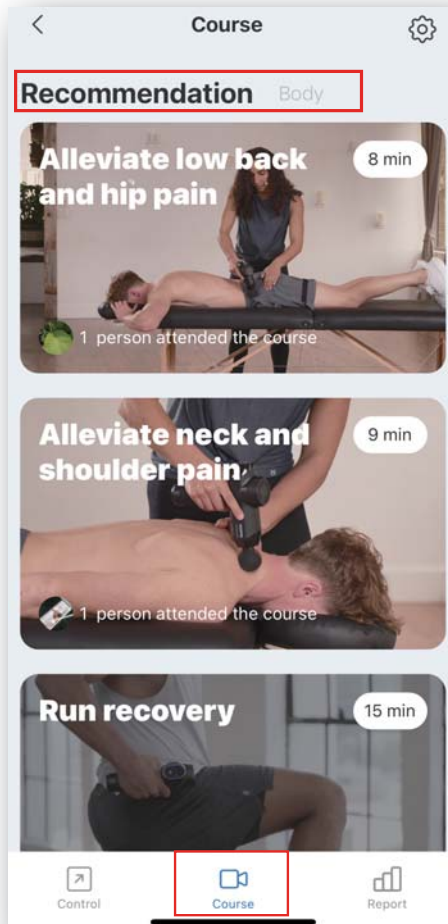

- Method 2: Choose the video course

- Tap "Course" and choose "Recommendation" for specific session or choose "Body" for specific muscle group massage.
- Choose your preferred course. Each session consists of corresponding videos course(s) with tips on which massage head to use and duration.
- Tap "Start" to follow it to massage.



*** When the video is playing, you can tap it for additional settings.**

- 1) Tap  to pause the video or choose to exit/continue the video.
- 2) Tap  to freely choose another course.
- 3) Tap Auto  to switch between Auto mode (Default) and Manual mode.
- 4) Tap  to turn on/off the background music or adjust the music volume.

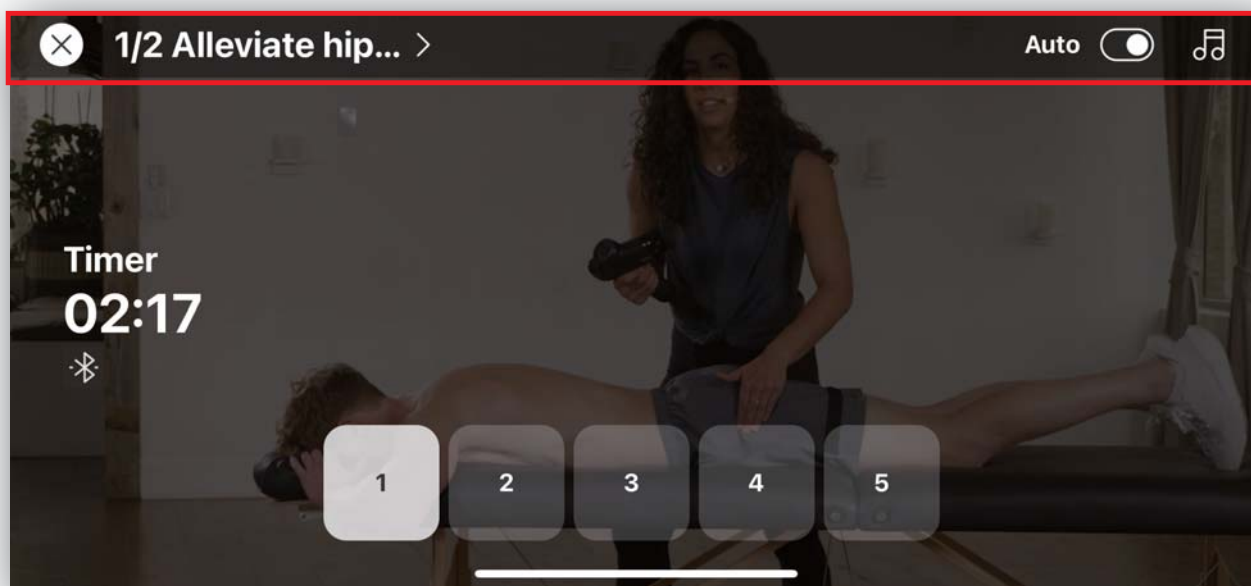

CLEANING AND MAINTENANCE

1. Turn off the device prior to cleaning. Use a soft towel or cloth to wipe the outer surfaces clean.
2. Do not attempt to disassemble or repair the device. The device does not contain user-serviceable parts.
3. Place the device in a cool, dry place when not in use.

TROUBLESHOOTING GUIDE

Problem	Cause	Solution
The device cannot be turned on.	Short press the Power button.	Press and hold the Power button for 2s to turn the device on.
	Battery runs out.	Charge the device.
The device stops working suddenly.	Auto-off timer: The device automatically shuts off after 10 minutes of continuous use.	Restart the device.
	Battery runs out.	Charge the device.
E1	The motor is locked.	Restart the device.
E2	The device is overheating.	Wait for the device to cool down before restarting it.
E3	The Power button is pressed while charging.	Do not turn on the device while charging.
Bluetooth connection fails.	Bluetooth on the smartphone is not enabled.	Enable Bluetooth on the smartphone.
	The massage gun is connected by another mobile device.	Unbind the massage gun on another mobile device.

WARRANTY POLICY

Your RENPHO product purchase is covered by a one year limited manufacturer warranty from the date of delivery. For warranty terms and conditions, please visit:

<https://renpho.com/pages/warranty-terms-and-conditions>

Note: Product registration is not required for the warranty. If you choose not to register your product, it will not diminish the product warranty.

CUSTOMER SERVICE

Please feel free to contact us if you have any questions or concerns. RENPHO Customer Service Team guarantees a quick response and hassle-free solutions to any issue you may have within business hours.

 **Tel: +1(844) 417 0149 (US ONLY)**
Monday-Friday 9:00AM-4:30PM
1800 MY RENPHO (1800 69 7367) (AU ONLY)
Monday-Friday 9:00AM-6:00PM (AEST)

 **Email: support@renpho.com (US&CA)**
support-au@renpho.com (AU)

*For defective products or the return of items, please contact us with your order number within the specified warranty period. DO NOT dispose of any product parts as they may be required for inspection/repair.

FCC Regulatory Compliance

This device complies with part 15 of the FCC Rules. Operation is subject to the following two conditions:

(1) This device may not cause harmful interference, and (2) this device must accept any interference received, including interference that may cause undesired operation.

Warning: Changes or modifications not expressly approved by the party responsible for compliance could void the user's authority to operate the equipment.

Note: This equipment has been tested and found to comply with the limits for a Class B digital device, pursuant to Part 15 of the FCC Rules. These limits are designed to provide reasonable protection against harmful interference in a residential installation. This equipment generates, uses and can radiate radio frequency energy and, if not installed and used in accordance with the instructions, may cause harmful interference to radio communications.

However, there is no guarantee that interference will not occur in a particular installation.

If this equipment does cause harmful interference to radio or television reception, which can be determined by turning the equipment off and on, the user is encouraged to try to correct the interference by one or more of the following measures:

- Reorient or relocate the receiving antenna.
- Increase the separation between the equipment and receiver.
- Connect the equipment into an outlet on a circuit different from that to which the receiver is connected.
- Consult the dealer or an experienced radio/TV technician for help.

RF Exposure Compliance

This equipment complies with FCC radiation exposure limits set forth for an uncontrolled environment. This transmitter must not be co-located or operating in conjunction with any other antenna or transmitter.

ISED Regulatory compliance

This device contains licence-exempt transmitters that comply with Innovation, Science and Economic Development Canada's licence-exempt RSS(s).

Operation is subject to the following two conditions:

(1) This device may not cause interference.

(2) This device must accept any interference, including interference that may cause undesired operation of the device.

Le présent appareil est conforme aux CNR d'Industrie Canada applicables aux appareils radio exempts de licence. L'exploitation est autorisée aux deux conditions suivantes:

(1) l'appareil ne doit pas produire de brouillage, et (2) l'utilisateur de l'appareil doit accepter tout brouillage radioélectrique subi, même si le brouillage est susceptible d'en compromettre le fonctionnement.

This equipment complies with IC RSS-102 radiation exposure limits set forth for an uncontrolled environment.

Cet équipement est conforme aux limites d'exposition aux radiations IC CNR-102 établies pour un environnement non contrôlé.

US Importer: JOICOM CORPORATION

14129 The Merge Street, Building 3 Unit A, Eastvale, CA 92880

Manufacturer: Sichuan Qianli-beoka Medical Technology Inc.

Longtan Industrial Park 2nd Sec, east 3rd ring road, Chenghua district,
Chengdu, Sichuan, China

Made in China

NA1