



# Test Report

**Report No.:** MTi210819008-01E1

**Date of issue:** Jan. 12, 2022

**Applicant:** YI ZHAO (SHENZHEN) CO.,  
LIMITED

**Product name:** Bluetooth Adapter

**Model(s):** H6 Bluetooth transmitter

**FCC ID:** 2A25A-H6F

Shenzhen Microtest Co., Ltd.  
<http://www.mtitest.com>



## Instructions

1. The report shall not be partially reproduced without the written consent of the laboratory;
2. The test results of this report are only responsible for the samples submitted;
3. This report is invalid without the seal and signature of the laboratory;
4. This report is invalid if transferred, altered or tampered with in any form without authorization;
5. Any objection to this report shall be submitted to the laboratory within 15 days from the date of receipt of the report.



## Table of Contents

<b>1</b>	<b>GENERAL INFORMATION .....</b>	<b>6</b>
1.1	DESCRIPTION OF EUT .....	6
1.2	OPERATION CHANNEL LIST .....	6
1.3	TEST CHANNEL LIST .....	7
1.4	ANCILLARY EQUIPMENT LIST .....	7
1.5	DESCRIPTION OF SUPPORT UNITS .....	7
<b>2</b>	<b>SUMMARY OF TEST RESULTS .....</b>	<b>8</b>
<b>3</b>	<b>TEST FACILITIES AND ACCREDITATIONS .....</b>	<b>9</b>
3.1	TEST LABORATORY .....	9
3.2	ENVIRONMENTAL CONDITIONS .....	9
3.3	MEASUREMENT UNCERTAINTY .....	9
3.4	TEST SOFTWARE .....	9
<b>4</b>	<b>EQUIPMENT LIST .....</b>	<b>10</b>
<b>5</b>	<b>TEST RESULT .....</b>	<b>11</b>
5.1	ANTENNA REQUIREMENT .....	11
5.1.1	<i>Standard requirement</i> .....	11
5.1.2	<i>EUT antenna</i> .....	11
5.2	PEAK OUTPUT POWER .....	12
5.2.1	<i>Limit</i> .....	12
5.2.2	<i>Test setup</i> .....	12
5.2.3	<i>Test procedure</i> .....	12
5.2.4	<i>Test results</i> .....	12
5.3	CONDUCTED EMISSION .....	19
5.3.1	<i>Limits</i> .....	19
5.3.2	<i>Test setup</i> .....	19
5.3.3	<i>Test procedure</i> .....	20
5.3.4	<i>Test results</i> .....	20
5.4	RADIATED SPURIOUS EMISSION .....	21
5.4.1	<i>Limits</i> .....	21
5.4.2	<i>Test setup</i> .....	22
5.4.3	<i>Test procedure</i> .....	23
5.4.4	<i>Test results</i> .....	24
5.4.5	<i>Band edge – radiated</i> .....	28
5.5	20dB OCCUPIED CHANNEL BANDWIDTH .....	29
5.5.1	<i>Limit</i> .....	29
5.5.2	<i>Test setup</i> .....	29
5.5.3	<i>Test procedure</i> .....	29
5.5.4	<i>Test results</i> .....	29
5.6	CARRIER FREQUENCY SEPARATION .....	36
5.6.1	<i>Limit</i> .....	36
5.6.2	<i>Test setup</i> .....	36
5.6.3	<i>Test procedure</i> .....	36
5.6.4	<i>Test results</i> .....	36
5.7	HOPPING CHANNEL .....	42
5.7.1	<i>Limit</i> .....	42
5.7.2	<i>Test setup</i> .....	42
5.7.3	<i>Test procedure</i> .....	42
5.7.4	<i>Test results</i> .....	42
5.8	DWELL TIME .....	45



5.8.1	Limit .....	45
5.8.2	Test setup .....	45
5.8.3	Test procedure.....	45
5.8.4	Test results.....	45
5.9	CONDUCTED BAND EDGE.....	52
5.9.1	Limit .....	52
5.9.2	Test setup .....	52
5.9.3	Test procedure.....	52
5.9.4	Test results.....	52
5.10	SPURIOUS RF CONDUCTED EMISSIONS .....	59
5.10.1	Limit.....	59
5.10.2	Measuring instruments.....	59
5.10.3	Test setup.....	59
5.10.4	Test procedure .....	59
5.10.5	Test results .....	59
<b>PHOTOGRAPHS OF THE TEST SETUP.....</b>		<b>62</b>
<b>PHOTOGRAPHS OF THE EUT.....</b>		<b>63</b>



**TEST RESULT CERTIFICATION**

Applicant's name.....	YI ZHAO (SHENZHEN) CO., LIMITED
Address.....	6th Floor, T3 Creative Building, Creative Expo City, No.5010 Baoan Avenue, Hangcheng Street, Baoan District, Shenzhen
Manufacturer's Name .....	YI ZHAO (SHENZHEN) CO., LIMITED
Address.....	6th Floor, T3 Creative Building, Creative Expo City, No.5010 Baoan Avenue, Hangcheng Street, Baoan District, Shenzhen

**Product description**

Product name.....	Bluetooth Adapter
Trademark .....	EKSA
Model Name .....	H6 Bluetooth transmitter
Serial Model .....	N/A
Standards.....	FCC Part 15.247
Test procedure .....	ANSI C63.10-2013

**Date of Test**

Date (s) of performance of tests..... :	Sept. 08, 2021 ~Oct. 08, 2021
Test Result .....	Pass

This device described above has been tested by Shenzhen Microtest Co., Ltd. and the test results show that the equipment under test (EUT) is in compliance with the FCC requirements. And it is applicable only to the tested sample identified in the report.

**Testing Engineer** : *Cindy Qin*  
(Cindy Qin)

**Technical Manager** : *Leon Chen*  
(Leon Chen)

**Authorized Signatory** : *Tom Xue*  
(Tom Xue)

## 1 General Information

### 1.1 Description of EUT

Product name:	Bluetooth Adapter
Model name:	H6 Bluetooth transmitter
Serial model:	N/A
Difference in series models:	N/A
Operation frequency:	2402-2480MHz
Modulation type:	GFSK, $\pi/4$ -DQPSK,8DPSK
Bit Rate of transmitter:	1 Mbps, 2Mbps, 3Mbps
Antenna type:	PCB Antenna
Antenna gain:	2dBi
Max. output power:	5.282dBm
Hardware version:	V03
Software version:	V1.3.2
Power source:	DC 5V
Adapter information:	N/A
Battery:	N/A
Serial number:	MTi210819008-01-S0001

### 1.2 Operation channel list

Channel	Frequency (MHz)	Channel	Frequency (MHz)	Channel	Frequency (MHz)
00	2402	27	2429	54	2456
01	2403	28	2430	55	2457
02	2404	29	2431	56	2458
03	2405	30	2432	57	2459
04	2406	31	2433	58	2460
05	2407	32	2434	59	2461
06	2408	33	2435	60	2462
07	2409	34	2436	61	2463
08	2410	35	2437	62	2464
09	2411	36	2438	63	2465



10	2412	37	2439	64	2466
11	2413	38	2440	65	2467
12	2414	39	2441	66	2468
13	2415	40	2442	67	2469
14	2416	41	2443	68	2470
15	2417	42	2444	69	2471
16	2418	43	2445	70	2472
17	2419	44	2446	71	2473
18	2420	45	2447	72	2474
19	2421	46	2448	73	2475
20	2422	47	2449	74	2476
21	2423	48	2450	75	2477
22	2424	49	2451	76	2478
23	2425	50	2452	77	2479
24	2426	51	2453	78	2480
25	2427	52	2454	--	--
26	2428	53	2455	--	--

**1.3 Test channel list**

Channel	Channel	Frequency (MHz)
Low	00	2402
Middle	39	2441
High	78	2480

**1.4 Ancillary equipment list**

Equipment	Model	S/N	Manufacturer	Certificate type
Laptop	E485	/	Lenovo	/

**1.5 Description of Support Units**

The EUT has been tested as an independent unit together with other necessary accessories or support units. The following support units or accessories were used to form a representative test configuration during the tests.

Item	Equipment	Brand	Model/Type No.	Series No.	Note
/	/	/	/	/	/

Note:

- (1) The support equipment was authorized by Declaration of Confirmation.
- (2) For detachable type I/O cable should be specified the length in cm in 『Length』 column.

## 2 Summary of Test Results

Test procedures according to the technical standards:

No.	Standard Section	Test Item	Result	Remark
1	15.203	Antenna requirement	Pass	
2	15.247(b)(1)	Peak output power	Pass	
3	15.207	Conducted emission	N/A	
4	15.247(d)	Band edge	Pass	
5	15.205/15.209	Spurious emission	Pass	
6	15.247(a)(1)	20dB occupied bandwidth	Pass	
7	15.247(a)(1)	Carrier Frequencies Separation	Pass	
8	15.247(a)(1)	Hopping channel number	Pass	
9	15.247(a)(1)	Dwell time	Pass	
10	15.247(d)	Spurious RF Conducted Emissions	Pass	



### 3 Test Facilities and Accreditations

#### 3.1 Test laboratory

Test Laboratory	Shenzhen Microtest Co., Ltd.
Location	101, No. 7, Zone 2, Xinxing Industrial Park, Fuhai Avenue, Xinhe Community, Fuhai Street, Bao' an District, Shenzhen, Guangdong, China.
FCC Registration No.:	448573

#### 3.2 Environmental conditions

Temperature:	15°C~35°C
Humidity	20%~75%
Atmospheric pressure	98kPa~101kPa

#### 3.3 Measurement uncertainty

The reported uncertainty of measurement  $y \pm U$  where expanded uncertainty  $U$  is based on a standard uncertainty multiplied by a coverage factor of  $k=2$  providing a level of confidence of approximately 95 %

No.	Item	Uncertainty
1	Conducted Emission Test	$\pm 1.38\text{dB}$
2	RF power, conducted	$\pm 0.16\text{dB}$
3	Spurious emissions, conducted	$\pm 0.21\text{dB}$
4	All emissions, radiated(<1G)	$\pm 4.68\text{dB}$
5	All emissions, radiated(>1G)	$\pm 4.89\text{dB}$
6	Temperature	$\pm 0.5^\circ\text{C}$
7	Humidity	$\pm 2\%$

#### 3.4 Test software

Software Name	Manufacturer	Model	Version
Bluetooth and WiFi Test System	Shenzhen JS tonskend co., ltd	JS1120-3	2.5.77.0418

#### 4 Equipment List

Equipment No.	Equipment Name	Manufacturer	Model	Serial No.	Calibration date	Due date
MTI-E043	EMI Test Receiver	Rohde&schwarz	ESCI7	101166	2021/06/02	2022/06/01
MTI-E044	TRILOG Broadband Antenna	schwarabeck	VULB 9163	9163-1338	2021/05/30	2023/05/29
MTI-E047	Amplifier	Hewlett-Packard	8447F	3113A06150	2021/06/02	2022/06/01
MTI-E089	ESG Vector Signal Generator	Agilent	N5182A	MY49060455	2021/06/02	2022/06/01
MTI-E058	ESG Series Analog Ssignal Generator	Agilent	E4421B	GB40051240	2021/06/02	2022/06/01
MTI-E062	PXA Signal Analyzer	Agilent	N9030A	MY51350296	2021/06/02	2022/06/01
MTI-E066	MXA Signal Analyzer	Agilent	N9020A	MY50143483	2021/06/02	2022/06/01
MTI-E078	Synthesized Sweeper	Agilent	83752A	3610A01957	2021/06/02	2022/06/01
MTI-E079	DC Power Supply	Agilent	E3632A	MY40027695	2021/06/02	2022/06/01
MTI-E045	Double Ridged Broadband Horn Antenna	schwarabeck	BBHA 9120 D	9120D-2278	2021/05/30	2023/05/29
MTI-E021	EMI Test Receiver	Rohde&schwarz	ESCS30	100210	2021/06/02	2022/06/01
MTI-E022	Pulse Limiter	Schwarzbeck	VSTD 9561-F	00679	2021/06/02	2022/06/01
MTI-E023	Artificial mains network	Schwarzbeck	NSLK 8127	NSLK 8127 #841	2021/06/02	2022/06/01
MTI-E046	Active Loop Antenna	Schwarzbeck	FMZB 1519 B	00044	2021/05/30	2023/05/29
MTI-E048	Amplifier	Agilent	8449B	3008A02400	2021/06/02	2022/06/01
MTI-E072	Thermometer Clock Humidity Monitor	-	HTC-1	/	2021/06/02	2022/06/01

Note: the calibration interval of the above test instruments is 12 or 24 months and the calibrations are traceable to international system unit (SI).

## **5 Test Result**

### **5.1 Antenna requirement**

#### **5.1.1 Standard requirement**

15.203 requirement: For intentional device, according to 15.203: an intentional radiator shall be designed to ensure that no antenna other than that furnished by the responsible party shall be used with the device

#### **5.1.2 EUT antenna**

The EUT antenna is PCB antenna (2dBi). It comply with the standard requirement. In case of replacement of broken antenna the same antenna type must be used.

## 5.2 Peak output power

### 5.2.1 Limit

FCC Part15 Subpart C			
Section	Test Item	Limit	Frequency Range (MHz)
15.247(b)(1)	Peak output power	Power<125mW (20.97dBm)	2400-2483.5

### 5.2.2 Test setup

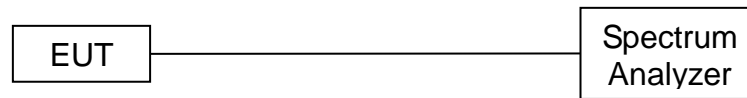

### 5.2.3 Test procedure

- (1) The EUT was directly connected to the spectrum analyzer and antenna output port as show in the block diagram above.
- (2) Spectrum Setting:  
 RBW=1MHz, VBW=3MHz, Detector=Peak (If 20dB BW ≤1 MHz)  
 RBW=3MHz, VBW=8MHz, Detector=Peak (If 20dB BW > 1 MHz)
- (3) The EUT was set to continuously transmitting in the max power during the test.

### 5.2.4 Test results



Test data

EUT:	Bluetooth Adapter	Model Name:	H6 Bluetooth transmitter
Pressure:	1012 hPa	Test Voltage:	DC 5V

GFSK

Test Channel	Frequency (MHz)	Maximum Peak Output Power(dBm)	Limit (dBm)
CH00	2402	2.529	20.97
CH39	2441	4.513	20.97
CH78	2480	4.819	20.97

$\pi/4$ -DQPSK

Test Channel	Frequency (MHz)	Maximum Peak Output Power(dBm)	Limit (dBm)
CH00	2402	2.320	20.97
CH39	2441	4.394	20.97
CH78	2480	4.802	20.97

8DPSK

Test Channel	Frequency (MHz)	Maximum Peak Output Power(dBm)	Limit (dBm)
CH00	2402	3.029	20.97
CH39	2441	5.025	20.97
CH78	2480	5.282	20.97



Test plots

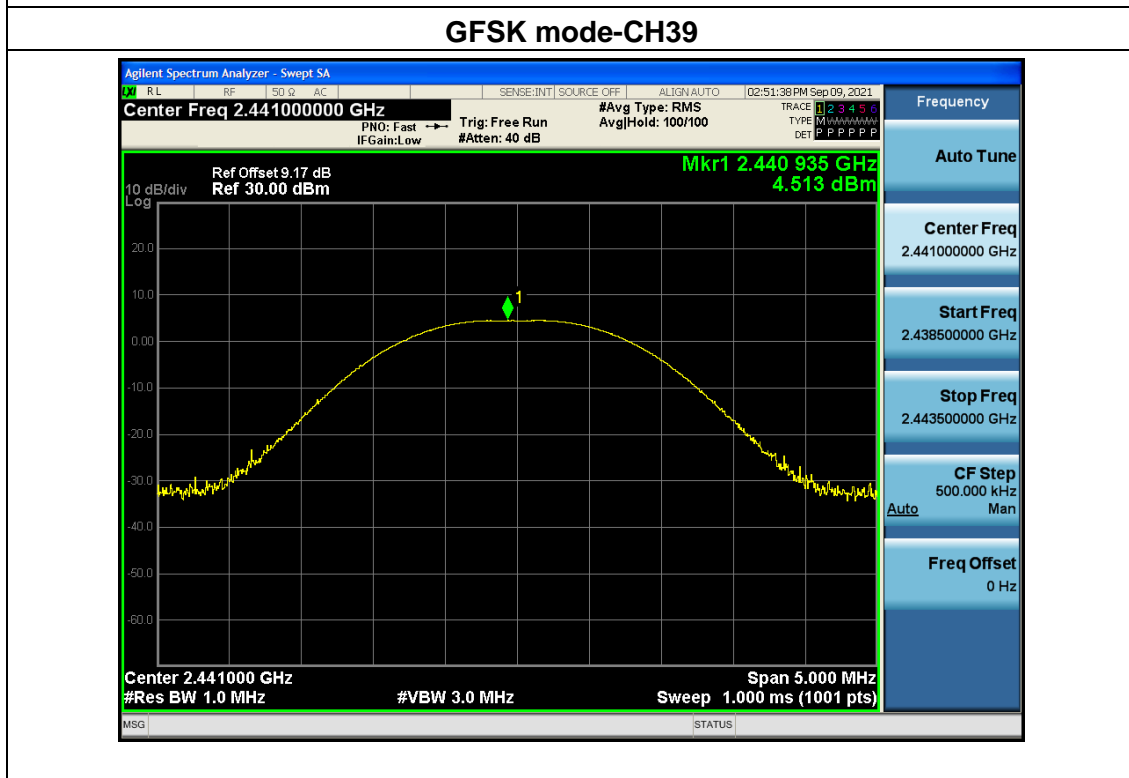
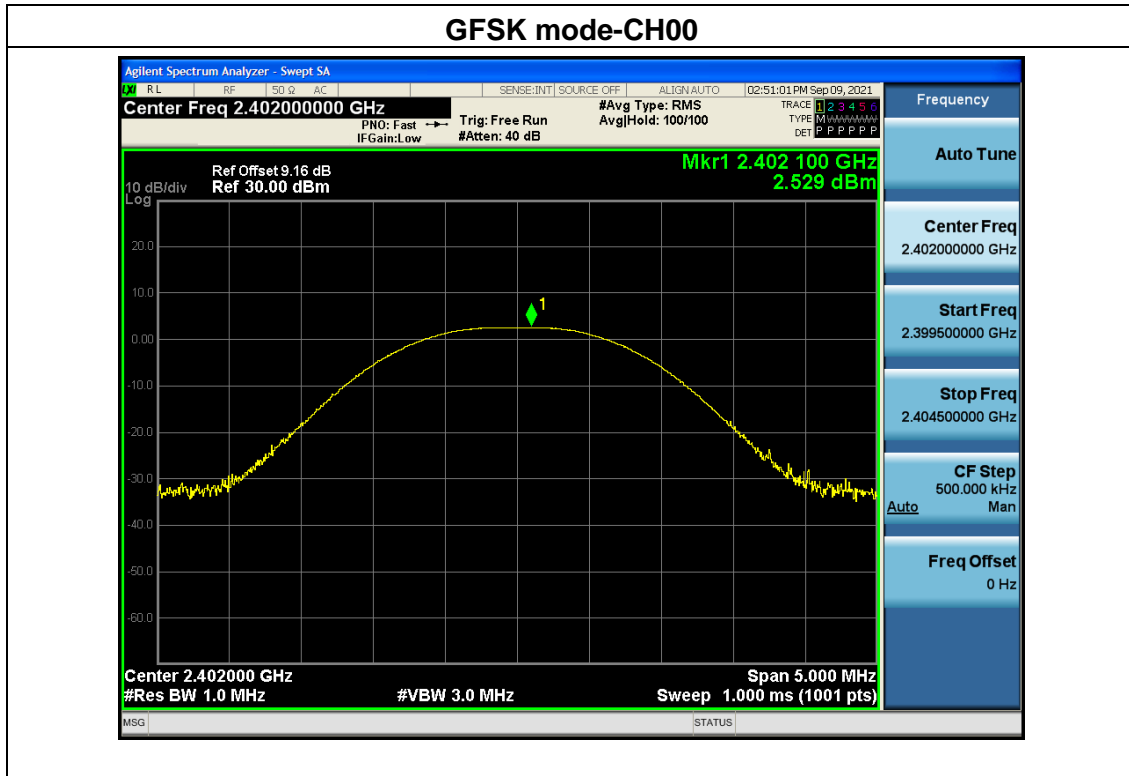



### GFSK mode-CH78

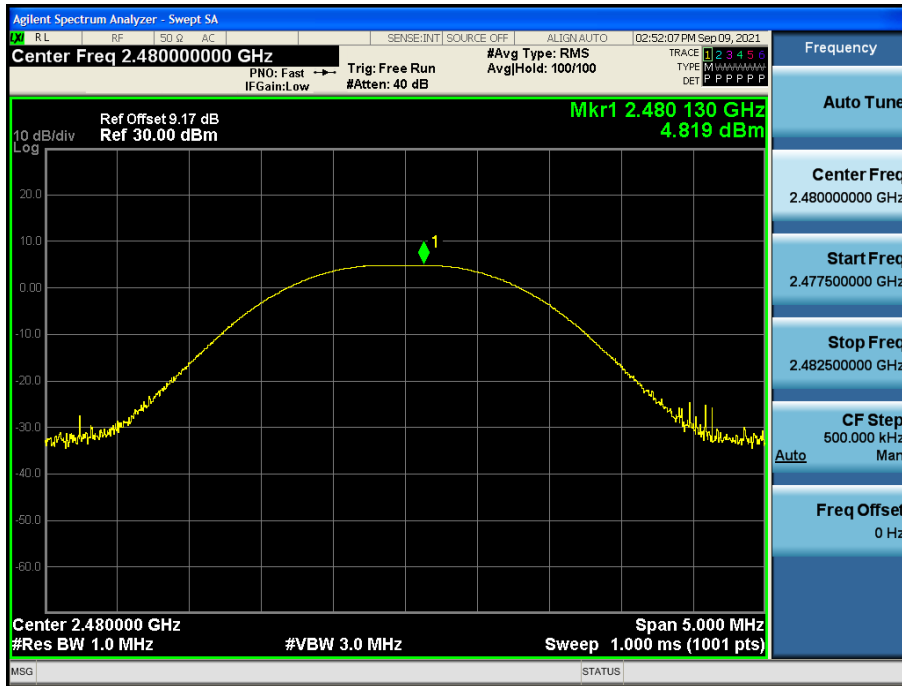

### $\pi/4$ -DQPSK mode-CH00

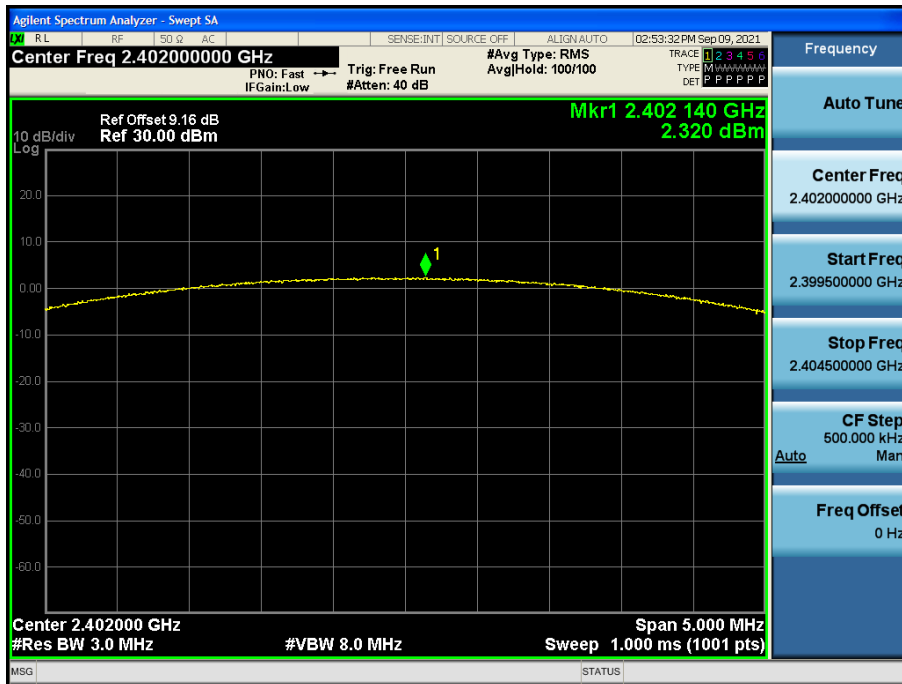



**$\pi/4$ -DQPSK mode-CH39**



**$\pi/4$ -DQPSK mode-CH78**

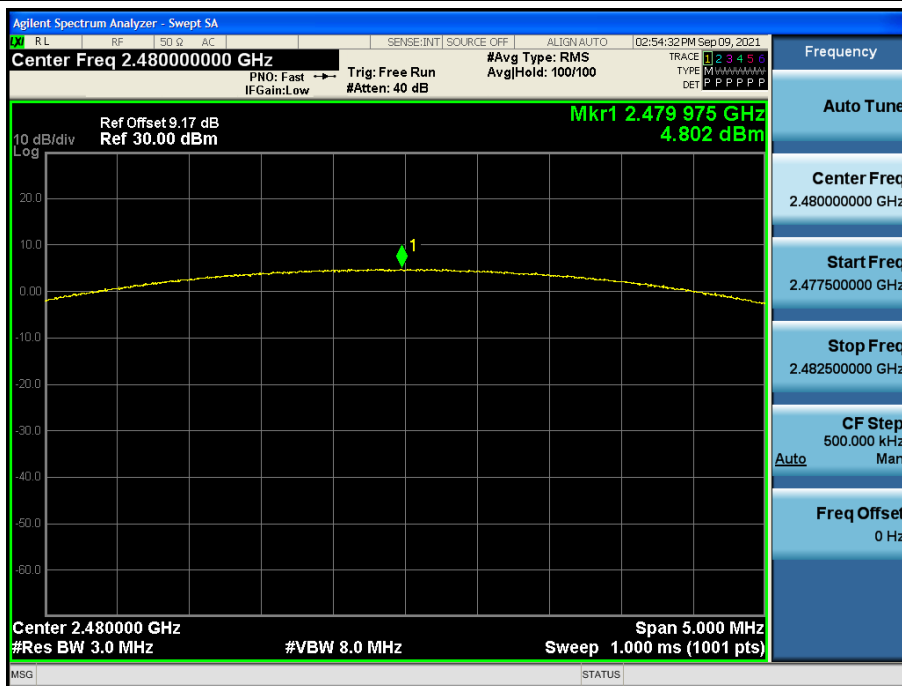





### 8DPSK mode-CH00



### 8DPSK mode-CH39





### 8DPSK mode-CH78



### 5.3 Conducted emission

#### 5.3.1 Limits

FREQUENCY (MHz)	Class B (dBuV)	
	Quasi-peak	Average
0.15 -0.5	66 - 56 *	56 - 46 *
0.50 -5.0	56.00	46.00
5.0 -30.0	60.00	50.00

Note: \*Decreases with the logarithm of the frequency.

#### 5.3.2 Test setup

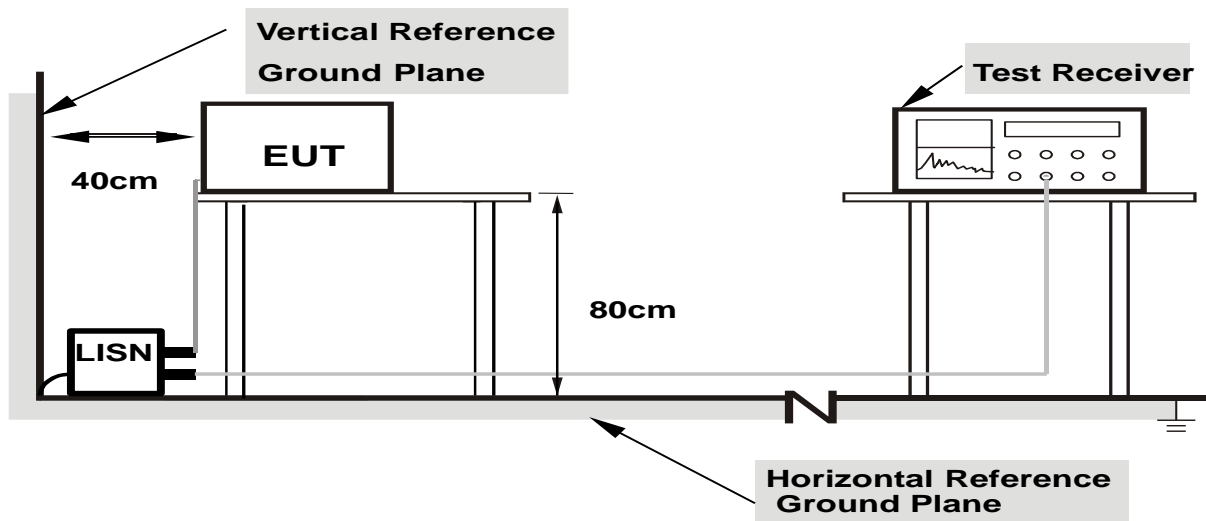

- Note:**
- 1.Support units were connected to second LISN.
  - 2.Both of LISNs (AMN) are 80 cm from EUT and at least 80 from other units and other metal planes

### 5.3.3 Test procedure

#### a. EUT Operating Conditions

The EUT was configured for testing in a typical fashion (as a customer would normally use it). The EUT has been programmed to continuously transmit during test. This operating condition was tested and used to collect the included data.

#### b. The following table is the setting of the receiver

Receiver Parameters	Setting
Attenuation	10 dB
Start Frequency	0.15 MHz
Stop Frequency	30 MHz
IF Bandwidth	9 kHz

- c. The EUT was placed 0.8 meters from the horizontal ground plane with EUT being connected to the power mains through a line impedance stabilization network (LISN). All other support equipments powered from additional LISN(s). The LISN provide 50 Ohm/ 50uH of coupling impedance for the measuring instrument.
- d. Interconnecting cables that hang closer than 40 cm to the ground plane shall be folded back and forth in the center forming a bundle 30 to 40 cm long.
- e. I/O cables that are not connected to a peripheral shall be bundled in the center. The end of the cable may be terminated, if required, using the correct terminating impedance. The overall length shall not exceed 1 m.
- f. LISN at least 80 cm from nearest part of EUT chassis.

For the actual test configuration, please refer to the related Item –EUT Test Photos.

### 5.3.4 Test results

Note: The device is a DC power supply and does not apply to conducted emissions.



## 5.4 Radiated spurious emission

### 5.4.1 Limits

20dBc in any 100 kHz bandwidth outside the operating frequency band. In case the emission fall within the restricted band specified on 15.205(a), then the 15.209(a) limit in the table below has to be followed.

Frequency (MHz)	Field Strength (micovolts/meter)	Measurement Distance (meters)
0.009~0.490	2400/F(kHz)	300
0.490~1.705	24000/F(kHz)	30
1.705~30.0	30	30
30~88	100	3
88~216	150	3
216~960	200	3
Above 960	500	3

Spectrum Parameter	Setting
Attenuation	Auto
Start Frequency	1000 MHz
Stop Frequency	10th carrier harmonic
RB / VB (emission in restricted band)	1 MHz / 1 MHz for Peak, 1 MHz / 10Hz for Average

Receiver Parameter	Setting
Attenuation	Auto
Start ~ Stop Frequency	9kHz~150kHz / RB 200Hz for QP
Start ~ Stop Frequency	150kHz~30MHz / RB 9kHz for QP
Start ~ Stop Frequency	30MHz~1000MHz / RB 120kHz for QP

### 5.4.2 Test setup

#### Radiated emission test-up frequency below 30MHz

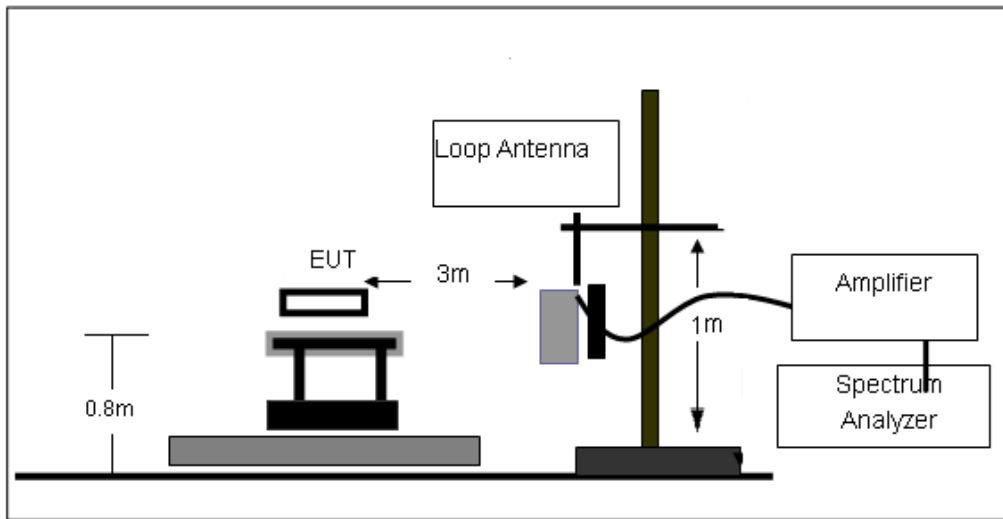

#### Radiated emission test-up frequency 30MHz~1GHz

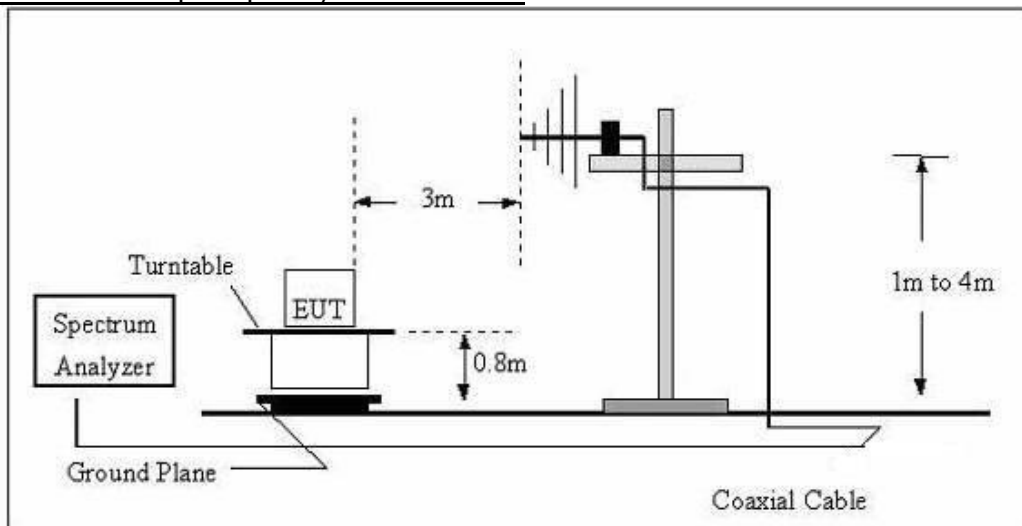

#### Radiated emission test-up frequency above 1GHz

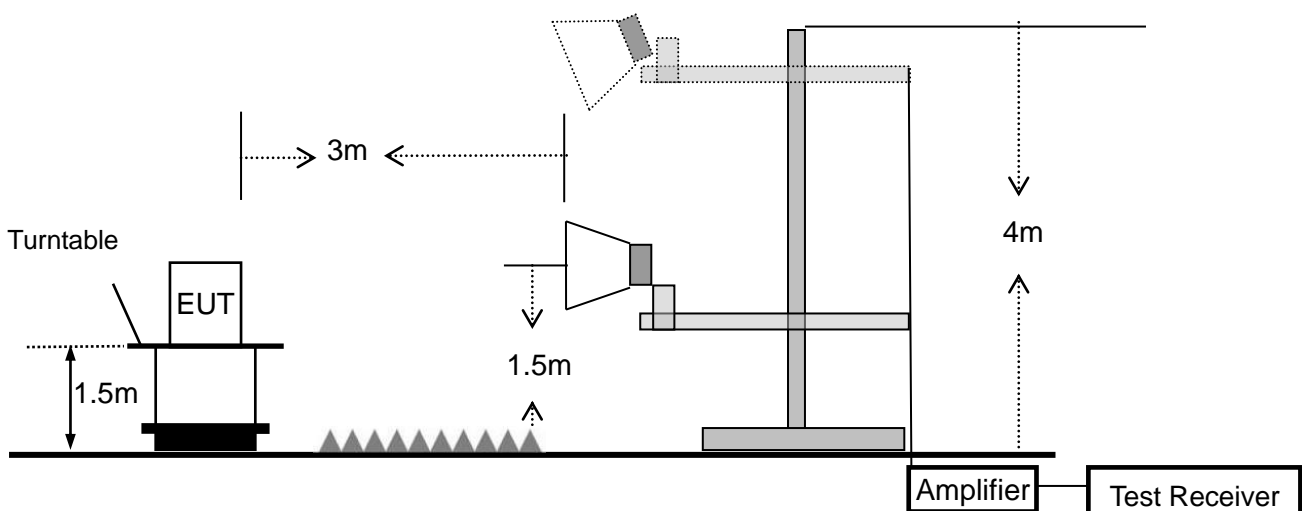

### 5.4.3 Test procedure

- a. EUT operating conditions. The EUT tested system was configured as the statements of 3.2 Unless otherwise a special operating condition is specified in the follows during the testing.
- b. The measuring distance of at 3 m shall be used for measurements at frequency up to 1GHz. For frequencies above 1GHz, any suitable measuring distance may be used.
- c. The EUT was placed on the top of a rotating table 0.8 meters above the ground at a 3 meter open area test site. The table was rotated 360 degrees to determine the position of the highest radiation.
- d. The height of the equipment or of the substitution antenna shall be 0.8 m; the height of the test antenna shall vary between 1 m to 4 m. Both horizontal and vertical polarizations of the antenna are set to make the measurement.
- e. For emission measurements above 1 GHz, the EUT shall be placed at a height of 1.5 m above the floor on a support that is RF transparent for the frequencies of interest. Final measurements for the EUT require a measurement antenna height scan of 1 m to 4 m.
- f. The initial step in collecting conducted emission data is a spectrum analyzer peak detector mode pre-scanning the measurement frequency range. Significant peaks are then marked and then Quasi Peak detector mode re-measured.
- g. If the Peak Mode measured value compliance with and lower than Quasi Peak Mode Limit, the EUT shall be deemed to meet QP Limits and then no additional QP Mode measurement performed.
- h. For the actual test configuration, please refer to the related Item –EUT Test photos.

Note: Both horizontal and vertical antenna polarities were tested. The worst case emissions were reported.

During the radiated emission test, the Spectrum Analyzer was set with the following configurations:

Frequency Band (MHz)	Function	Resolution bandwidth	Video Bandwidth
30 to 1000	QP	120 kHz	300 kHz
Above 1000	Peak	1 MHz	1 MHz
	Average	1 MHz	10 Hz

Note: for the frequency ranges below 30 MHz, a narrower RBW is used for these ranges but the measured value should add a RBW correction factor (RBWCF) where  $RBWCF [dB] = 10 \cdot \lg(100 [kHz] / \text{narrower RBW [kHz]})$ . , the narrower RBW is 1 kHz and RBWCF is 20 dB for the frequency 9 kHz to 150 kHz, and the narrower RBW is 10 kHz and RBWCF is 10 dB for the frequency 150 kHz to 30 MHz.

**5.4.4 Test results**
Below 30MHz

EUT:	Bluetooth Adapter	Model Name:	H6 Bluetooth transmitter
Pressure:	1010 hPa	Test Voltage:	DC 5V
Test Mode:	TX	Polarization:	--

Freq. (MHz)	Reading (dBuV/m)	Limit (dBuV/m)	Margin (dB)	State P/F
--	--	--	--	Pass
--	--	--	--	Pass

**Note:**

1. For 9kHz-30MHz, the amplitude of spurious emissions which are attenuated by more than 20dB below the permissible value has no need to be reported.
2. Distance extrapolation factor =  $40 \log(\text{specific distance}/\text{test distance})$ (dB);
3. Limit line = specific limits (dBuV) + distance extrapolation factor.





Between 30MHz – 1GHz

EUT:	Bluetooth Adapter	Model Name:	H6 Bluetooth transmitter
Pressure:	1010 hPa	Phase:	H
Test Mode:	TX	Test Voltage:	DC 5V

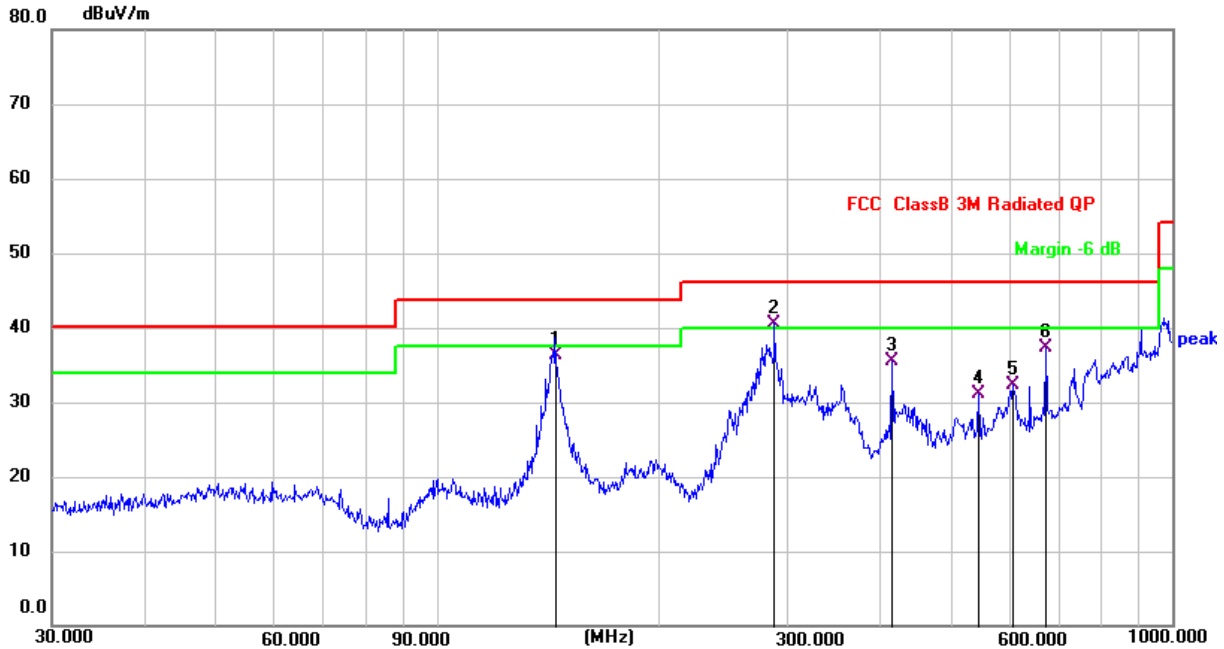

No.	Mk.	Freq. MHz	Reading Level dBuV	Correct Factor dB	Measure- ment dBuV/m	Limit dB/m	Over dB	Detector
1		144.8418	52.73	-16.33	36.40	43.50	-7.10	QP
2	*	287.9904	51.52	-10.92	40.60	46.00	-5.40	QP
3		416.1791	42.65	-7.15	35.50	46.00	-10.50	QP
4		545.1825	37.17	-6.09	31.08	46.00	-14.92	QP
5		607.7866	36.45	-4.10	32.35	46.00	-13.65	QP
6		672.8442	40.39	-3.00	37.39	46.00	-8.61	QP



EUT:	Bluetooth Adapter	Model Name:	H6 Bluetooth transmitter
Pressure:	1010 hPa	Phase:	V
Test Mode:	TX	Test Voltage:	DC 5V

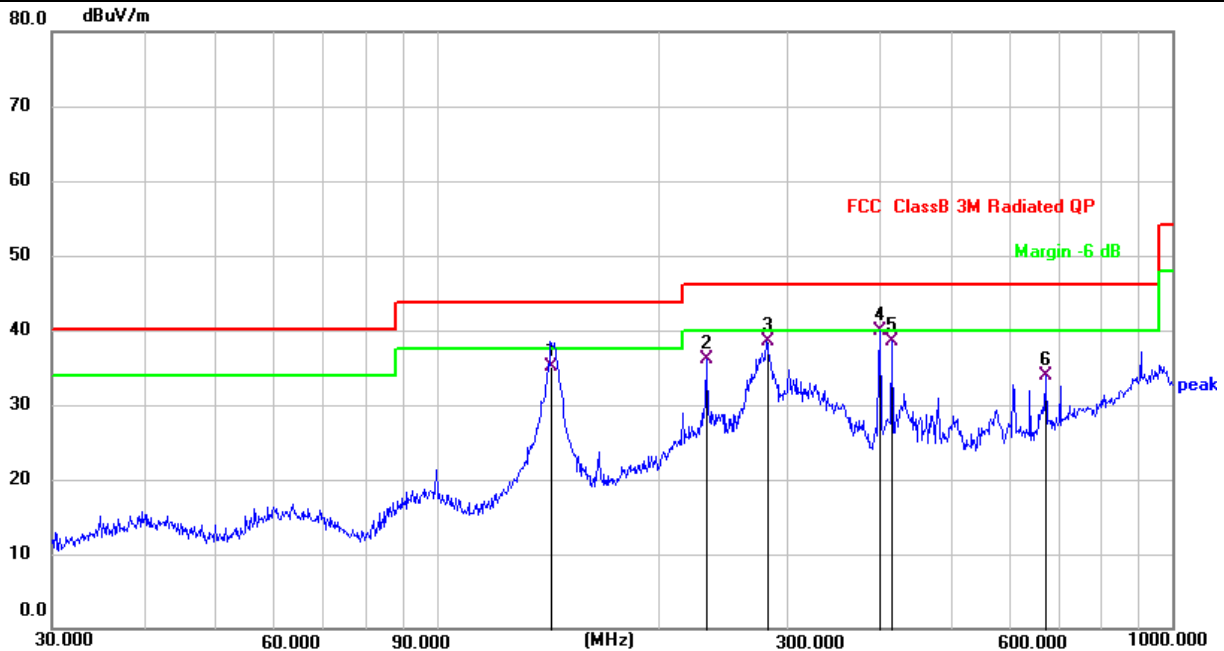

No.	Mk.	Freq. MHz	Reading Level dBuV	Correct Factor dB	Measure- ment dBuV/m	Limit dB/m	Over dB	Detector
1		142.8243	51.00	-15.90	35.10	43.50	-8.40	QP
2		232.5318	48.67	-12.60	36.07	46.00	-9.93	QP
3		281.0075	48.94	-10.37	38.57	46.00	-7.43	QP
4	*	400.4318	46.97	-7.08	39.89	46.00	-6.11	QP
5		416.1791	45.67	-7.15	38.52	46.00	-7.48	QP
6		672.8442	36.96	-3.00	33.96	46.00	-12.04	QP

Note:

1. Emission Level = Meter Reading + Factor, Margin= Emission Level- Limit, Factor = Antenna Factor + Cable Loss – Pre-amplifier.
2. The three modulated high, medium and low channels have been tested. The report only shows the worst mode. The worst mode is 8DPSK CH78.



**1GHz-25GHz**

Frequency	Read Level	Cable loss	Antenna Factor	Preamp Factor	Emission Level	Limits	Margin	Remark	Comment
(MHz)	(dBμV)	(dB)	dB/m	(dB)	(dBμV/m)	(dBμV/m)	(dB)		
<b>Low Channel (2402 MHz)( 8DPSK)--Above 1G</b>									
4804.629	63.09	4.36	32.92	45.53	54.84	74.00	-19.16	Pk	Vertical
4804.629	43.33	4.36	32.92	45.53	35.08	54.00	-18.92	AV	Vertical
7206.567	60.82	5.02	37.63	45.56	57.91	74.00	-16.09	Pk	Vertical
7206.567	41.66	5.02	37.63	45.56	38.75	54.00	-15.25	AV	Vertical
4804.396	61.18	4.36	32.92	45.53	52.93	74.00	-21.07	Pk	Horizontal
4804.396	43.31	4.36	32.92	45.53	35.06	54.00	-18.94	AV	Horizontal
7206.424	60.81	5.02	37.63	45.56	57.90	74.00	-16.10	Pk	Horizontal
7206.424	48.77	5.02	37.63	45.56	45.86	54.00	-8.14	AV	Horizontal
<b>Mid Channel (2441 MHz)( 8DPSK)--Above 1G</b>									
4881.539	61.73	4.43	33.04	45.81	53.39	74.00	-20.61	Pk	Vertical
4881.539	41.39	4.43	33.04	45.81	33.05	54.00	-20.95	AV	Vertical
7322.142	59.18	5.02	37.71	45.62	56.29	74.00	-17.71	Pk	Vertical
7322.142	42.80	5.02	37.71	45.62	39.91	54.00	-14.09	AV	Vertical
4881.285	58.69	4.43	33.04	45.81	50.35	74.00	-23.65	Pk	Horizontal
4881.285	47.20	4.43	33.04	45.81	38.86	54.00	-15.14	AV	Horizontal
7322.199	57.71	5.02	37.71	45.62	54.82	74.00	-19.18	Pk	Horizontal
7322.199	47.61	5.02	37.71	45.62	44.72	54.00	-9.28	AV	Horizontal
<b>High Channel (2480 MHz)( 8DPSK)-- Above 1G</b>									
4959.223	60.57	4.50	33.26	46.07	52.26	74.00	-21.74	Pk	Vertical
4959.223	40.59	4.50	33.26	46.07	32.28	54.00	-21.72	AV	Vertical
7439.201	61.83	5.02	37.78	45.77	58.86	74.00	-15.14	Pk	Vertical
7439.201	46.22	5.02	37.78	45.77	43.25	54.00	-10.75	AV	Vertical
4959.165	61.63	4.50	33.26	46.07	53.32	74.00	-20.68	Pk	Horizontal
4959.165	48.07	4.50	33.26	46.07	39.76	54.00	-14.24	AV	Horizontal
7439.264	59.28	5.02	37.78	45.77	56.31	74.00	-17.69	Pk	Horizontal
7439.264	46.78	5.02	37.78	45.77	43.81	54.00	-10.19	AV	Horizontal

**Note:**

1. All Readings are Peak Value (VBW=3MHz) and AV Value (VBW=10Hz).
2. Emission Level= Antenna Factor + Cable Loss + Read Level - Preamp Factor.
3. All the modulation modes have been tested, and only the worst results are reflected in the report.



**5.4.5 Band edge – radiated**

Frequency (MHz)	Meter Reading (dBμV)	Cable Loss (dB)	Antenna Factor dB/m	Preamp Factor (dB)	Emission Level (dBμV/m)	Limits (dBμV/m)	Margin (dB)	Detector Type	Comment
3Mbps(8DPSK)- non-hopping									
2310.00	60.42	2.40	27.70	40.40	50.12	74	-23.88	Pk	Horizontal
2310.00	42.83	2.40	27.70	40.40	32.53	54	-21.47	AV	Horizontal
2310.00	63.93	2.40	27.70	40.40	53.63	74	-20.37	Pk	Vertical
2310.00	42.08	2.40	27.70	40.40	31.78	54	-22.22	AV	Vertical
2390.00	60.29	2.44	28.30	40.10	50.93	74	-23.07	Pk	Vertical
2390.00	41.45	2.44	28.30	40.10	32.09	54	-21.91	AV	Vertical
2390.00	59.95	2.44	28.30	40.10	50.59	74	-23.41	Pk	Horizontal
2390.00	42.14	2.44	28.30	40.10	32.78	54	-21.22	AV	Horizontal
2400.00	64.42	2.46	28.30	40.10	55.08	74	-18.92	Pk	Vertical
2400.00	44.27	2.46	28.30	40.10	34.93	54	-19.07	AV	Vertical
2400.00	63.98	2.46	28.30	40.10	54.64	74	-19.36	Pk	Horizontal
2400.00	43.52	2.46	28.30	40.10	34.18	54	-19.82	AV	Horizontal
2483.50	62.03	2.48	28.70	39.80	53.41	74	-20.59	Pk	Vertical
2483.50	40.58	2.48	28.70	39.80	31.96	54	-22.04	AV	Vertical
2483.50	60.93	2.48	28.70	39.80	52.31	74	-21.69	Pk	Horizontal
2483.50	42.24	2.48	28.70	39.80	33.62	54	-20.38	AV	Horizontal
2500.00	60.57	2.48	28.70	39.80	51.95	74	-22.05	Pk	Vertical
2500.00	42.47	2.48	28.70	39.80	33.85	54	-20.15	AV	Vertical
2500.00	60.32	2.48	28.70	39.80	51.70	74	-22.30	Pk	Horizontal
2500.00	43.05	2.48	28.70	39.80	34.43	54	-19.57	AV	Horizontal

Note:

1. All Readings are Peak Value (VBW=3MHz) and AV Value (VBW=10Hz).
2. Emission Level= Antenna Factor + Cable Loss + Read Level - Preamp Factor.
3. All the modulation modes have been tested, and only the worst results are reflected in the report.

## 5.5 20dB occupied channel bandwidth

### 5.5.1 Limit

FCC Part15 (15.247) , Subpart C			
Section	Test Item	Limit	Frequency Range (MHz)
15.247a(1)	20dB bandwidth	N/A	2400-2483.5

### 5.5.2 Test setup

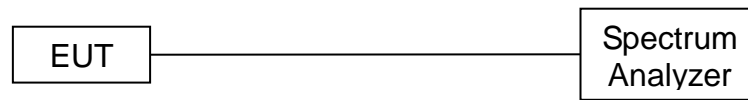

### 5.5.3 Test procedure

- (1) The EUT was directly connected to the spectrum analyzer and antenna output port as show in the block diagram above.
- (2) Spectrum Setting:  
 Bandwidth: RBW=30 kHz, VBW=100 kHz, detector= Peak

### 5.5.4 Test results



Test data

EUT:	Bluetooth Adapter	Model Name:	H6 Bluetooth transmitter
Pressure:	1012 hPa	Test Voltage:	DC 5V

Mode	Frequency (MHz)	20dB Bandwidth (MHz)	Limit (kHz)	Result
GFSK	2402	0.9644	N/A	Pass
	2441	0.9622	N/A	Pass
	2480	0.9639	N/A	Pass
$\pi/4$ -DQPSK	2402	1.3340	N/A	Pass
	2441	1.3340	N/A	Pass
	2480	1.3420	N/A	Pass
8DPSK	2402	1.3120	N/A	Pass
	2441	1.3050	N/A	Pass
	2480	1.3140	N/A	Pass



Test plots

GFSK mode



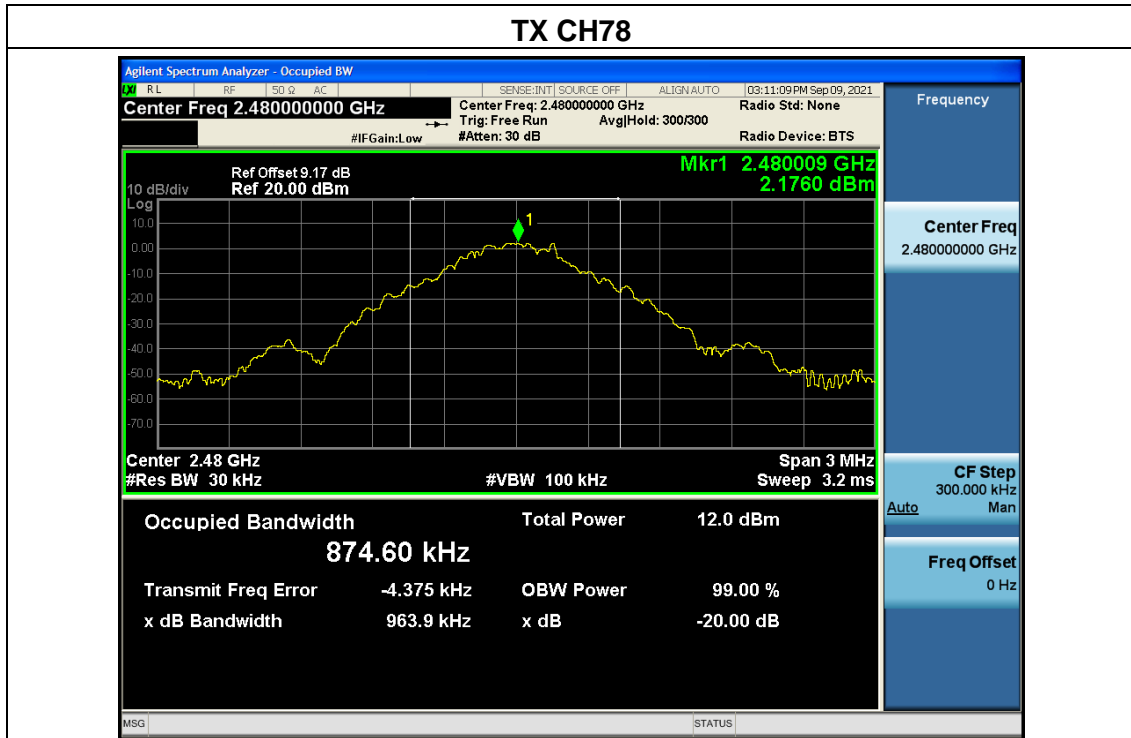

$\pi/4$ -DQPSK

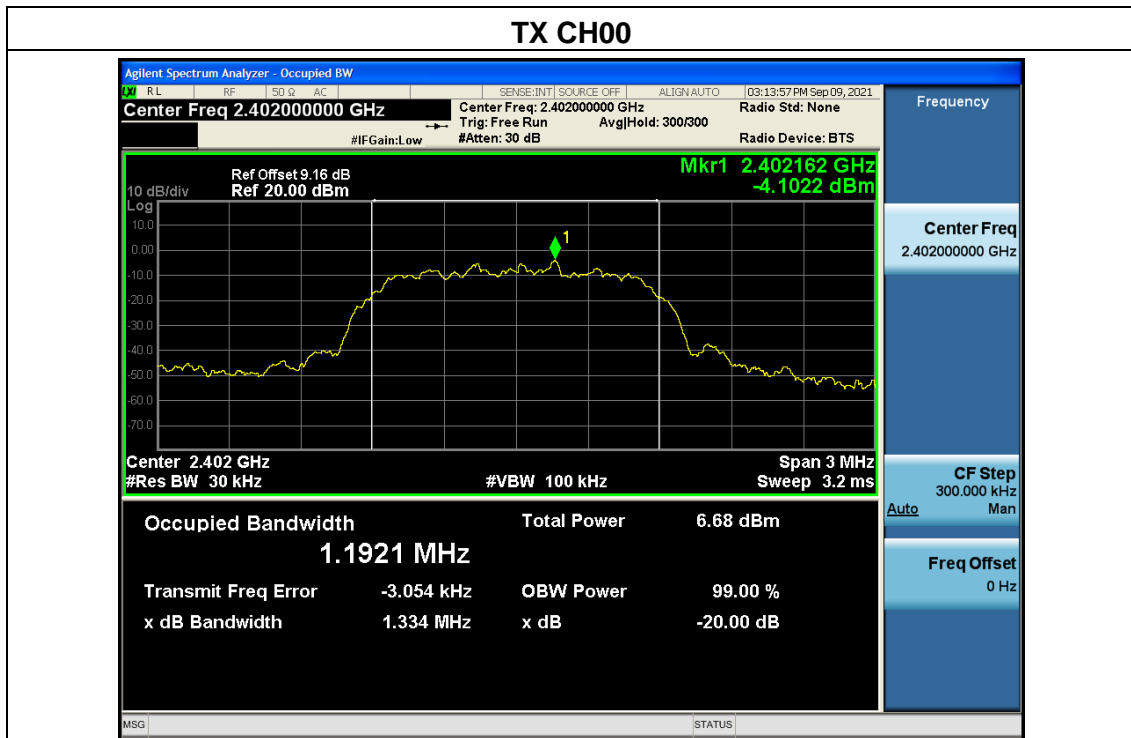





### TX CH39

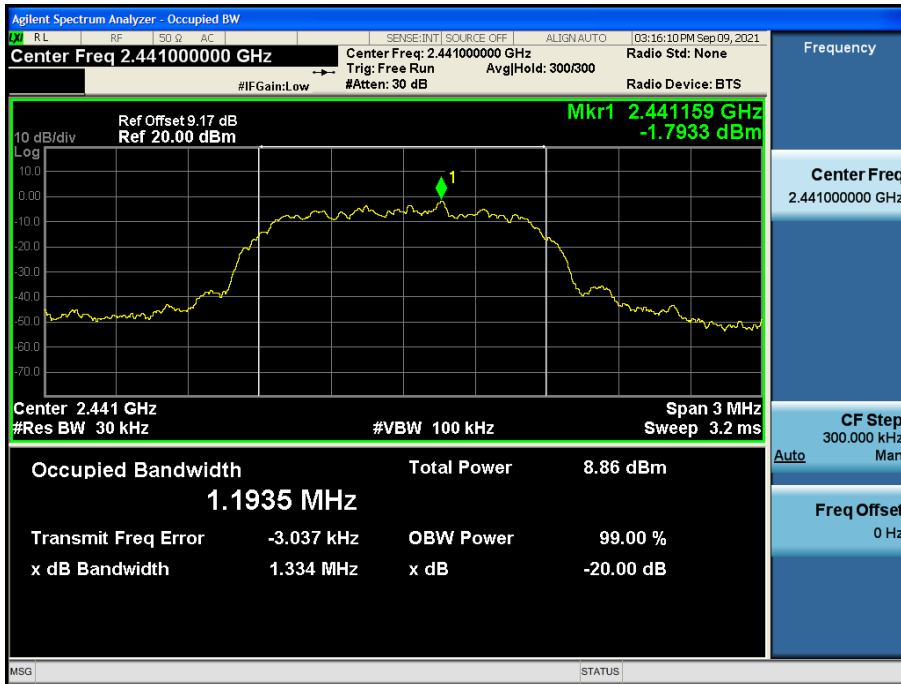

### TX CH78

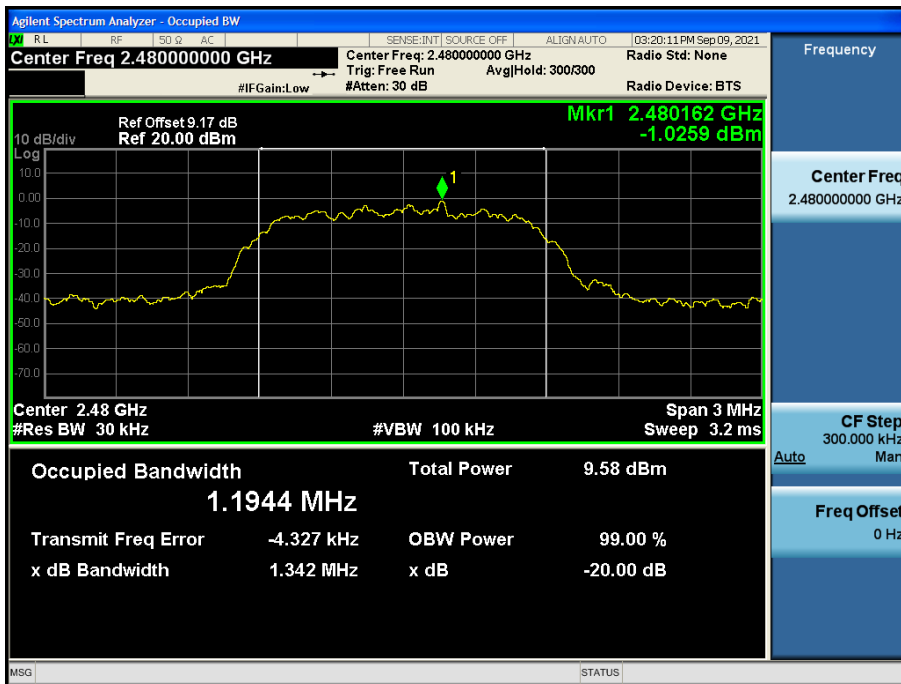



8DPSK mode

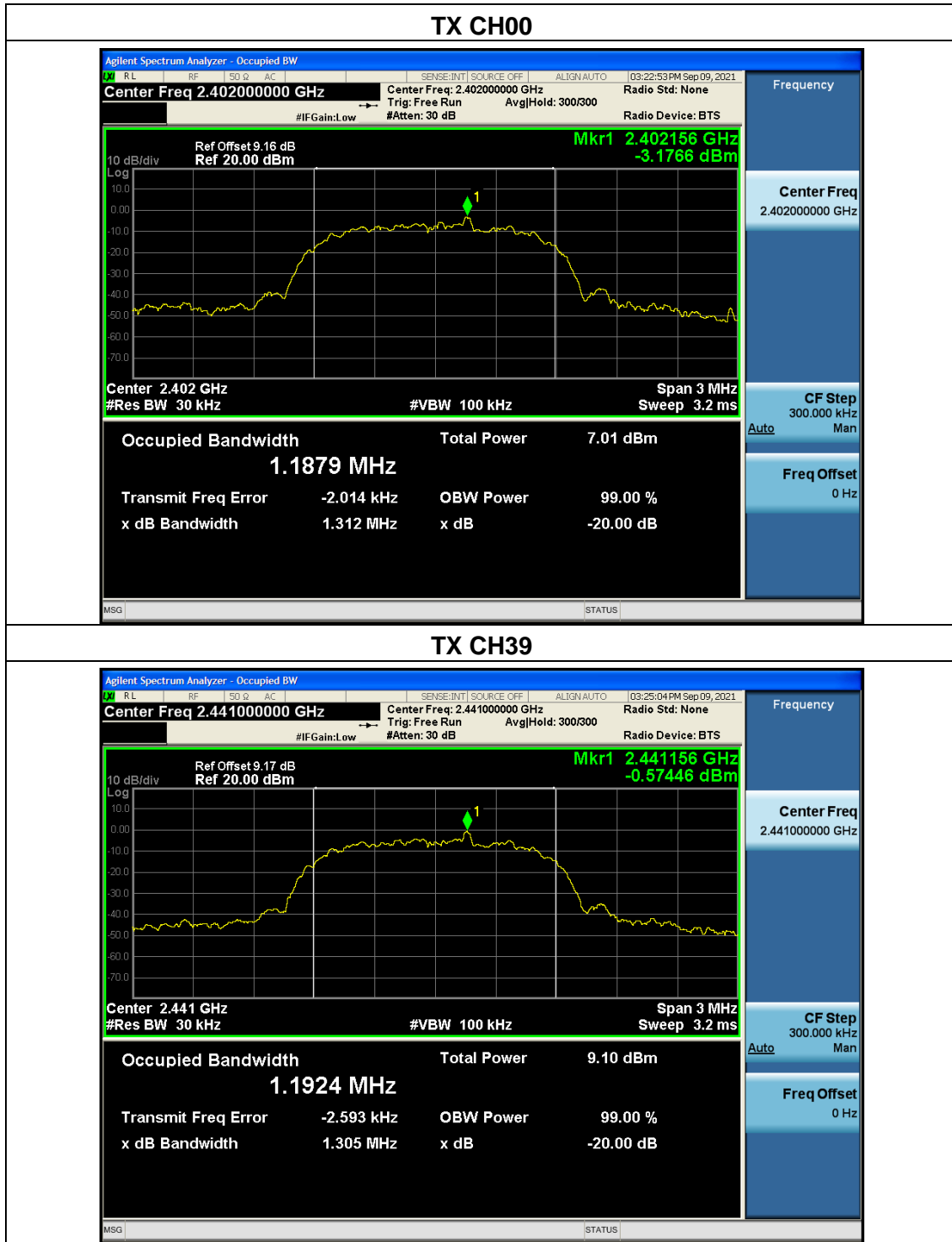

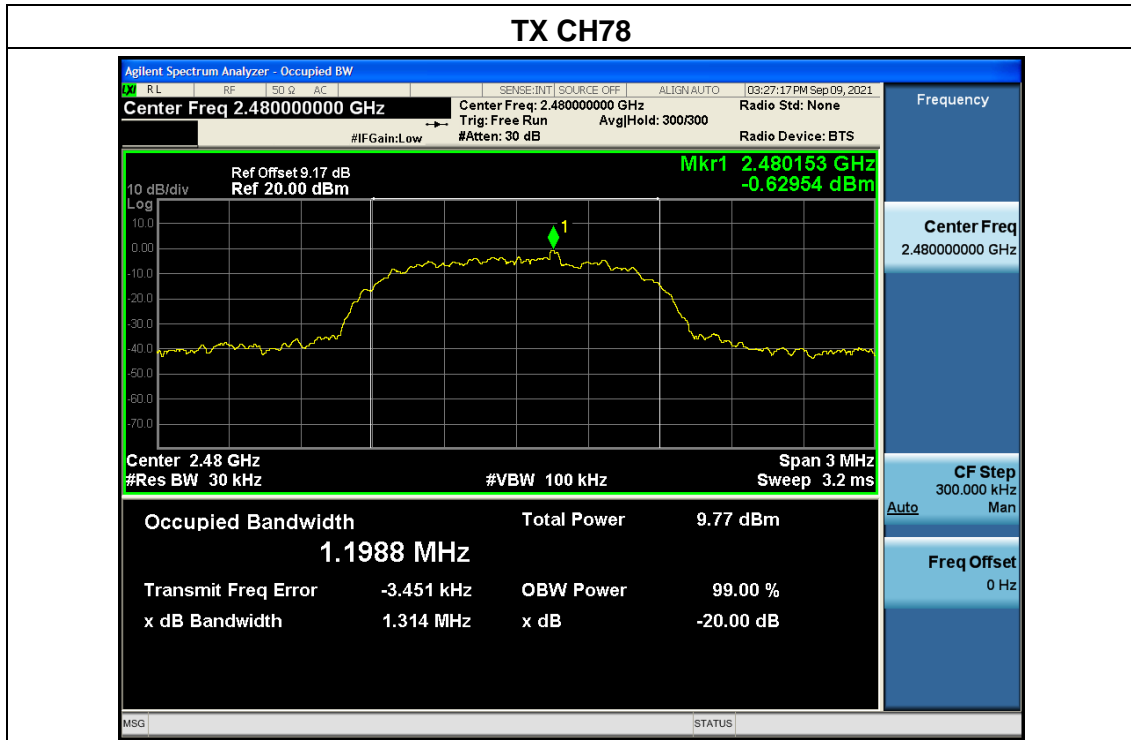

## 5.6 Carrier frequency separation

### 5.6.1 Limit

FCC Part15 (15.247) , Subpart C			
Section	Test Item	Limit	Frequency Range (MHz)
15.247(a)(1)	Channel Separation	>25kHz or >two-thirds of the 20 dB bandwidth (Which is greater)	2400-2483.5

### 5.6.2 Test setup

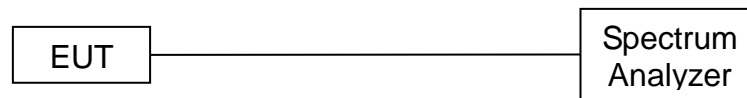

### 5.6.3 Test procedure

- (1) The EUT was directly connected to the spectrum analyzer and antenna output port as show in the block diagram above.
- (2) Spectrum Setting:  
 RBW=30 kHz, VBW=100 kHz, detector= Peak, Sweep Time =auto.
- (3) The EUT was set to the Hopping Mode for Channel Separation Test and continuously transmitting for the Test.

### 5.6.4 Test results

**Test data**

EUT:	Bluetooth Adapter	Model Name:	H6 Bluetooth transmitter
Pressure:	1012 hPa	Test Voltage:	DC 5V
Test Mode:	GFSK, $\pi/4$ -DQPSK, 8DPSK /CH00, CH39, CH78		

Mode	Channel	Frequency (MHz)	Test Result (kHz)	Limit (kHz)		Result
GFSK	Low	2402	1000	643	2/3 of 20dB BW	Pass
	Middle	2441	998	641	2/3 of 20dB BW	Pass
	High	2480	1000	643	2/3 of 20dB BW	Pass
$\pi/4$ -DQPSK	Low	2402	998	889	2/3 of 20dB BW	Pass
	Middle	2441	1000	889	2/3 of 20dB BW	Pass
	High	2480	1004	895	2/3 of 20dB BW	Pass
8DPSK	Low	2402	1004	875	2/3 of 20dB BW	Pass
	Middle	2441	998	870	2/3 of 20dB BW	Pass
	High	2480	1000	876	2/3 of 20dB BW	Pass

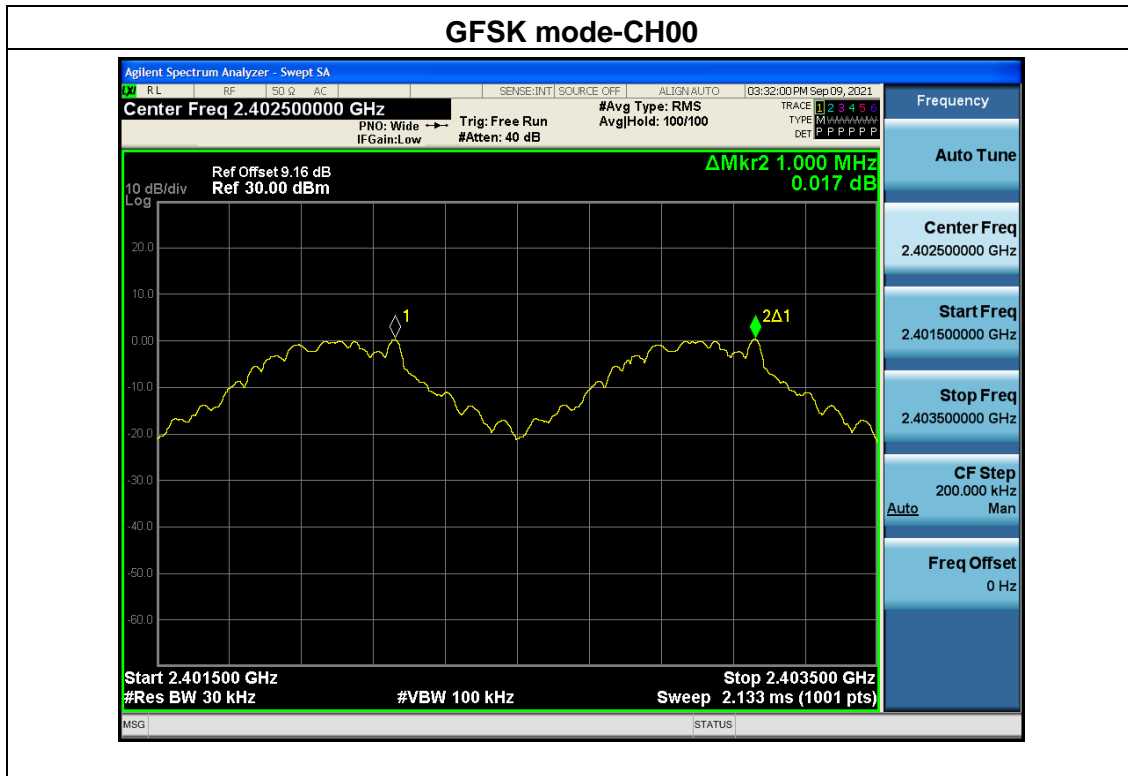
**Test plots**



### GFSK mode-CH39



### GFSK mode-CH78





**$\pi/4$ -DQPSK mode-CH00**

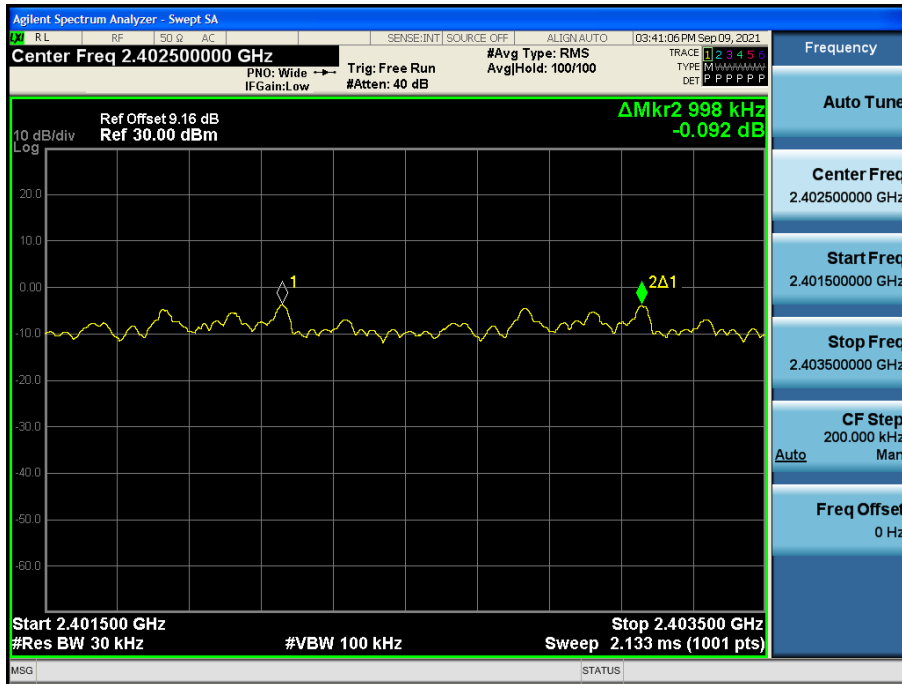

**$\pi/4$ -DQPSK mode-CH39**

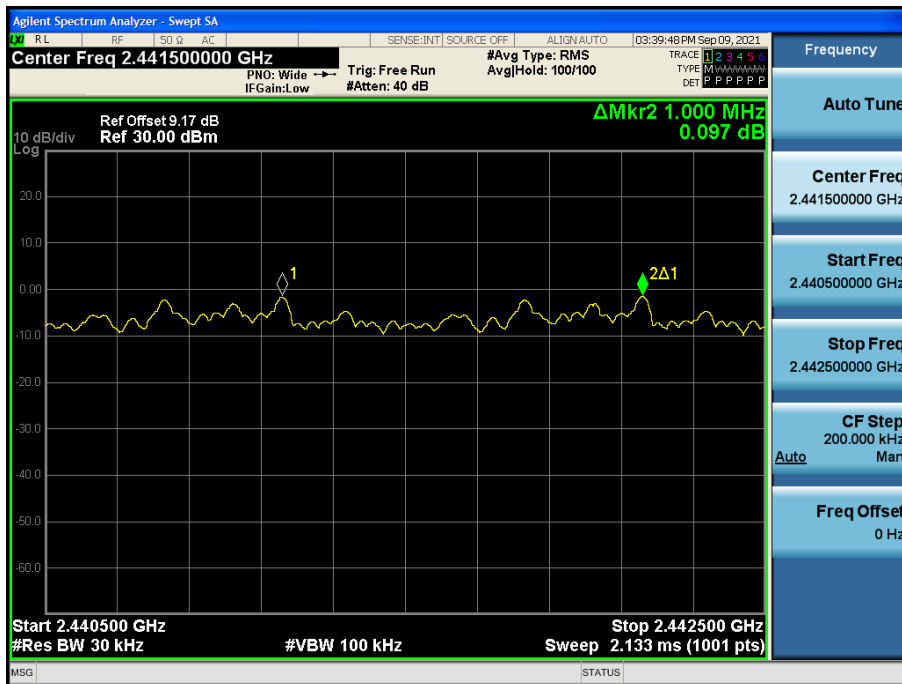



**$\pi/4$ -DQPSK mode-CH78**

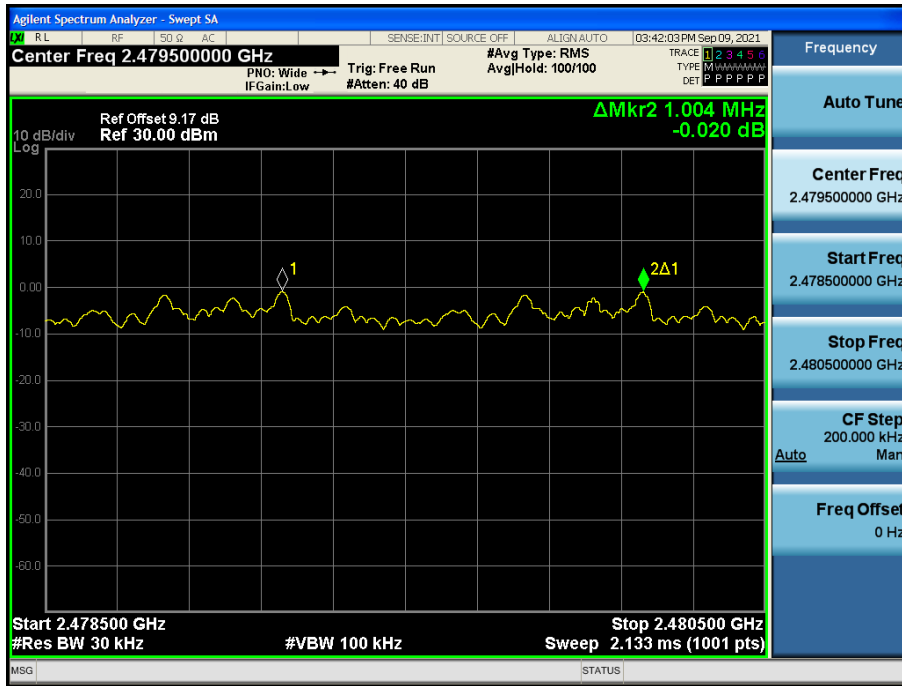

**8DPSK mode-CH00**

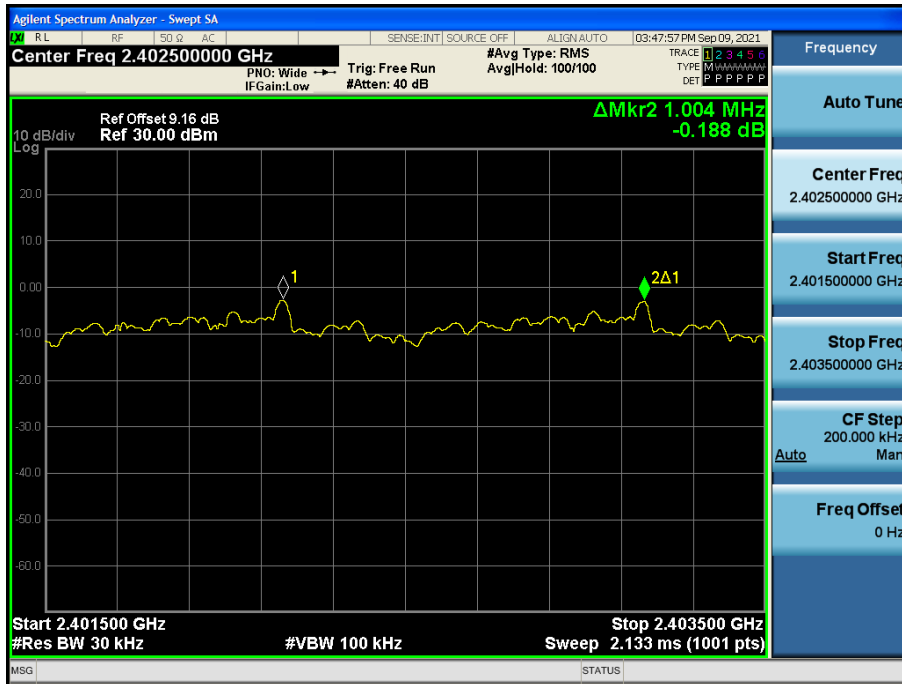





**8DPSK mode-CH39**

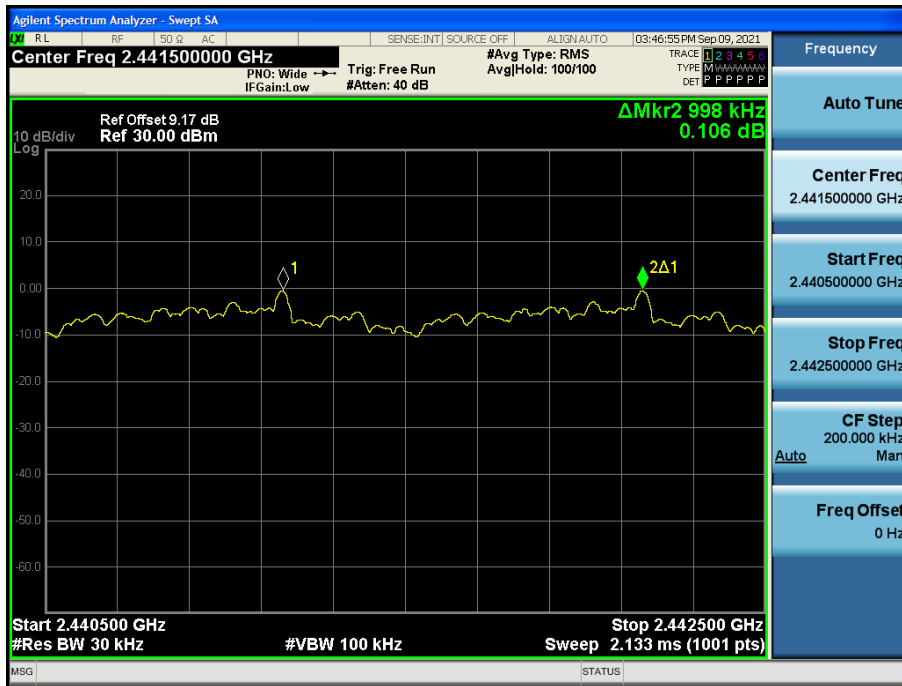

**8DPSK mode-CH78**

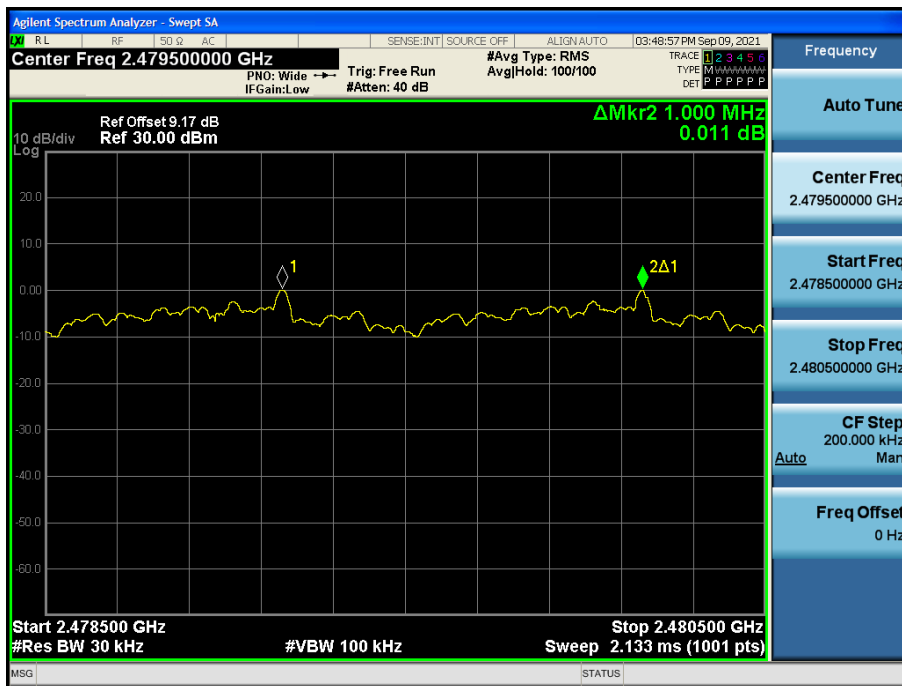

## 5.7 Hopping Channel

### 5.7.1 Limit

Frequency hopping systems in the 2400-2483.5MHz band shall use at least 15 channels.

### 5.7.2 Test setup

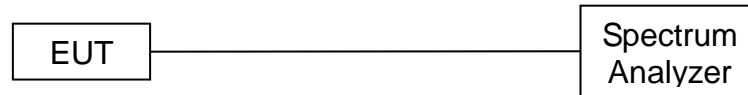

### 5.7.3 Test procedure

The testing follows ANSI C63.10-2013 clause 7.8.3

The RF output of EUT was connected to the spectrum analyzer by RF cable and attenuator.

The path loss was compensated to the results for each measurement.

Set to the maximum power setting and enable the EUT transmit continuously.

The EUT must have its hopping function enabled.

Use the following spectrum analyzer settings:

Span = the frequency band of operation

RBW : To identify clearly the individual channels, set the RBW to less than 30% of the channel spacing or the 20 dB bandwidth, whichever is smaller.

VBW  $\geq$  RBW

Sweep = auto

Detector function = peak

Trace = max hold

### 5.7.4 Test results



Mode	Quantity of Hopping Channel	Limit	Results
GFSK, $\pi/4$ -DQPSK, 8DPSK	79	>15	Pass

Test plots

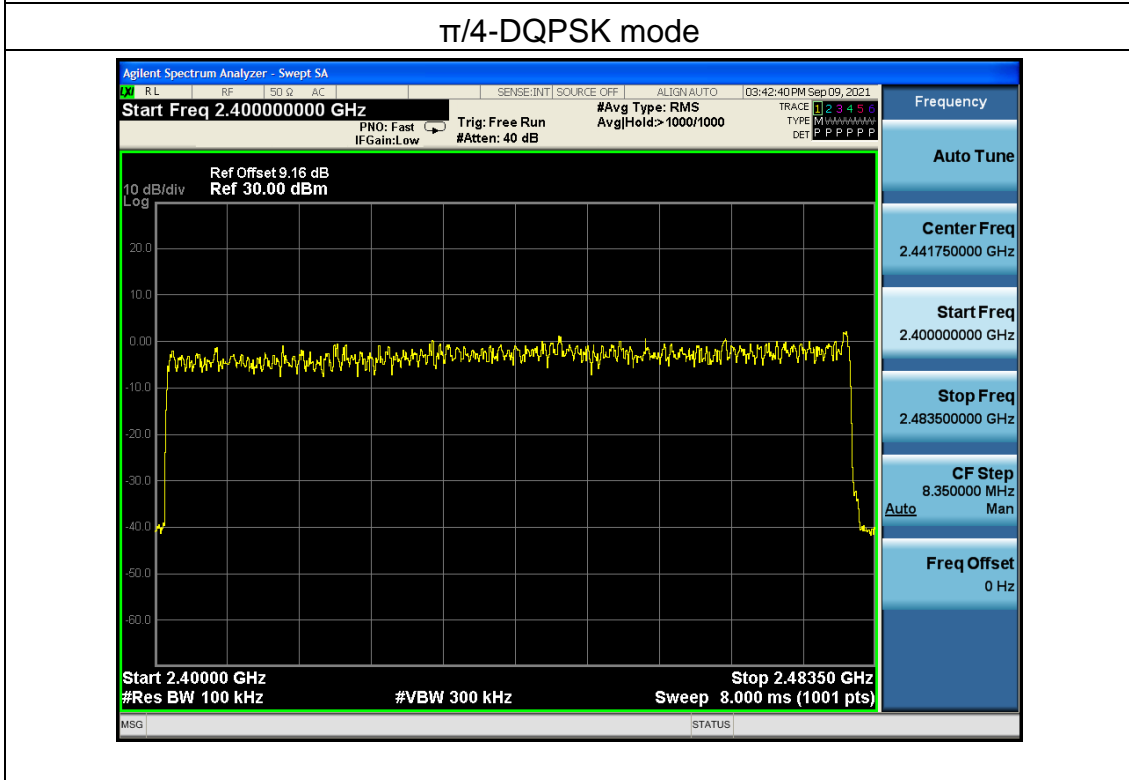
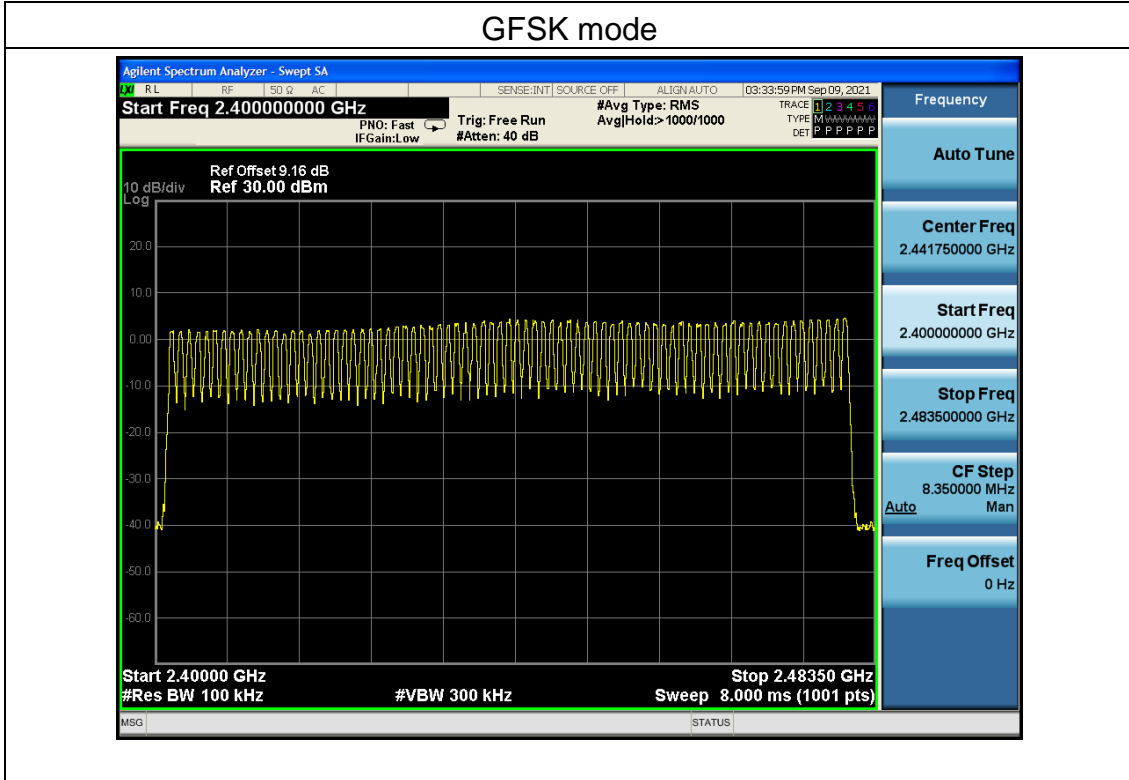



### 8DPSK mode



## 5.8 Dwell time

### 5.8.1 Limit

FCC Part15 (15.247) , Subpart C			
Section	Test Item	Limit	Frequency Range (MHz)
15.247(a)(1)	Dwell time	0.4 sec	2400-2483.5

### 5.8.2 Test setup

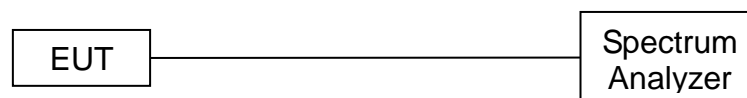

### 5.8.3 Test procedure

- (1) The EUT was directly connected to the spectrum analyzer and antenna output port as show in the block diagram above.
- (2) Spectrum Setting: RBW=1MHz, VBW=3MHz, Span=0Hz, Detector=Peak
- (3) Use video trigger with the trigger level set to enable triggering only on full pulses.
- (4) Sweep Time is more than once pulse time.
- (5) Set the center frequency on any frequency would be measure and set the frequency span to zero span.
- (6) Measure the maximum time duration of one single pulse.
- (7) Set the EUT for packet transmitting.
- (8) Measure the maximum time duration of one single pulse.
- (9) The EUT was set to the Hopping Mode for Dwell Time Test.

### 5.8.4 Test results



Test data

EUT:	Bluetooth Adapter	Model Name:	H6 Bluetooth transmitter
Pressure:	1012 hPa	Test Voltage:	DC 5V
Test Mode:	GFSK, $\pi/4$ -DQPSK, 8DPSK /CH39		

Mode	Data Packet	Frequency (MHz)	Pulse Duration (ms)	Dwell Time (ms)	Limit(s)	Conclusion
GFSK	DH1	2441	0.3838	122.82	<0.4	Pass
	DH3	2441	1.6390	262.24	<0.4	Pass
	DH5	2441	2.8880	308.05	<0.4	Pass
$\pi/4$ DQPSK	2DH1	2441	0.3863	123.62	<0.4	Pass
	2DH3	2441	1.6380	262.08	<0.4	Pass
	2DH5	2441	2.8860	307.84	<0.4	Pass
8DPSK	3DH1	2441	0.3872	123.90	<0.4	Pass
	3DH3	2441	1.6360	261.76	<0.4	Pass
	3DH5	2441	2.8890	308.16	<0.4	Pass

Note:

1. A period time = 0.4 (s) \* 79 = 31.6(s)

2. DH1 time slot = Pulse Duration \* (1600/(2\*79)) \* A period time

DH3 time slot = Pulse Duration \* (1600/(4\*79)) \* A period time

DH5 time slot = Pulse Duration \* (1600/(6\*79)) \* A period time

3. For GFSK,  $\pi/4$ -DQPSK and 8DPSK: The test period: T= 0.4 Second/Channel x 79 Channel = 31.6 s



Test plots

Modulation mode		GFSK mode	
DH1			<p>Frequency</p> <p>Auto Tune</p> <p>Center Freq 2.441000000 GHz</p> <p>Start Freq 2.441000000 GHz</p> <p>Stop Freq 2.441000000 GHz</p> <p>CF Step 1.000000 MHz Auto Man</p> <p>Freq Offset 0 Hz</p>
DH3			<p>Frequency</p> <p>Auto Tune</p> <p>Center Freq 2.441000000 GHz</p> <p>Start Freq 2.441000000 GHz</p> <p>Stop Freq 2.441000000 GHz</p> <p>CF Step 1.000000 MHz Auto Man</p> <p>Freq Offset 0 Hz</p>

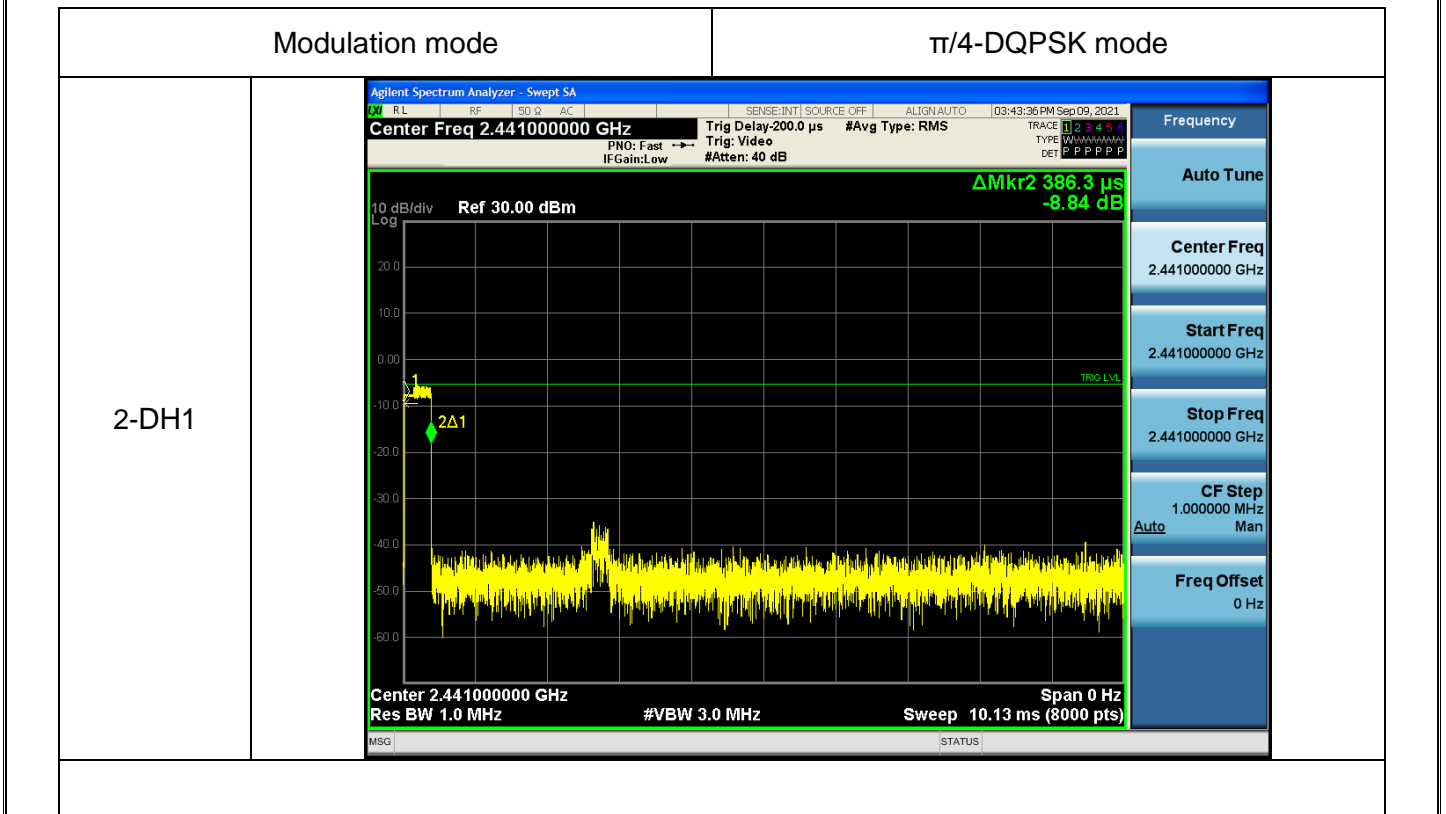
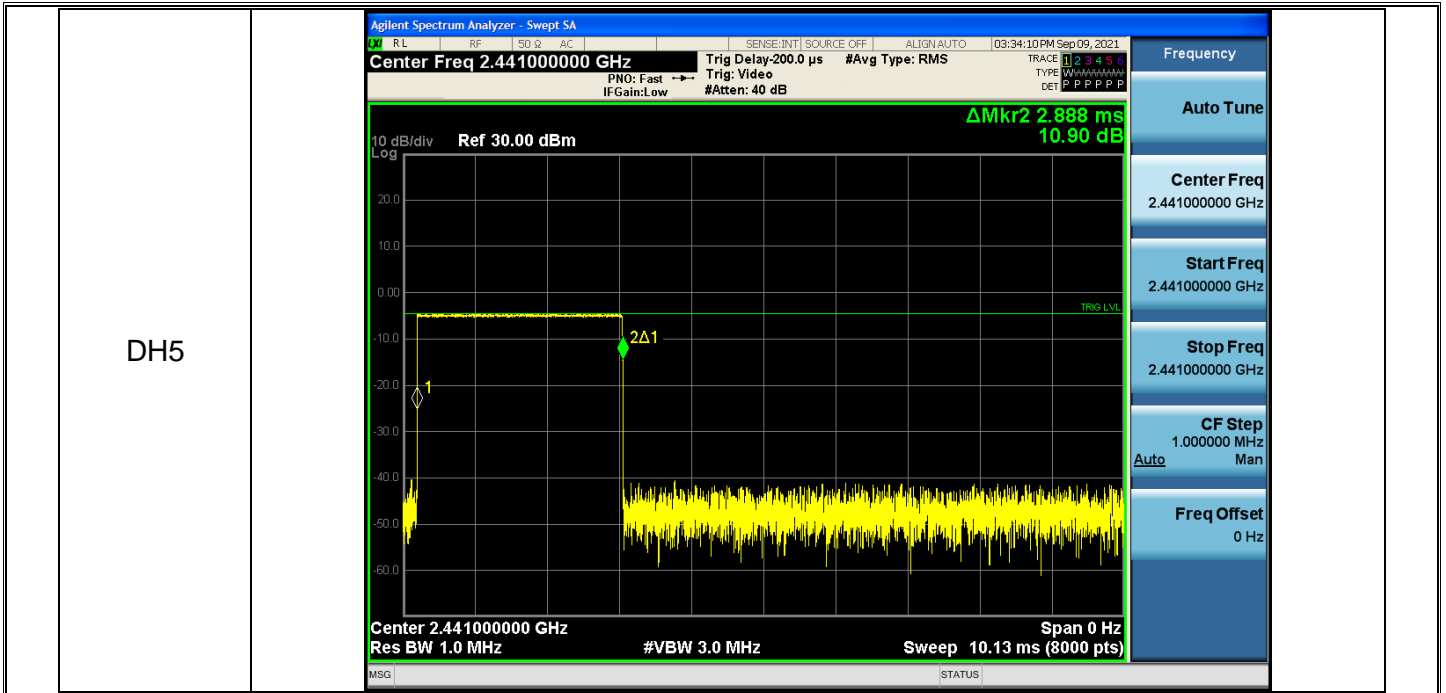





2-DH3

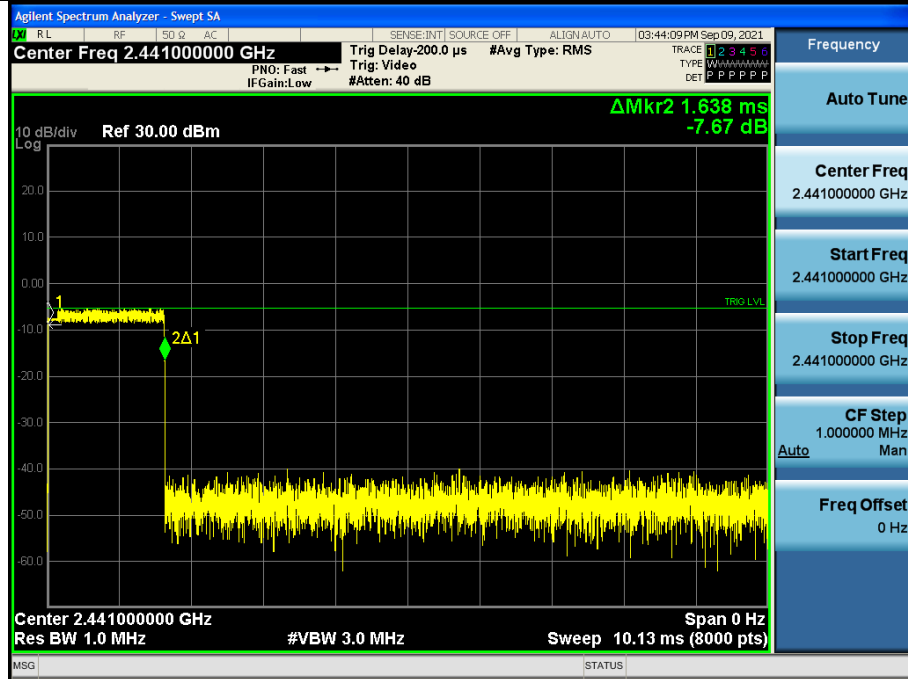

2-DH5

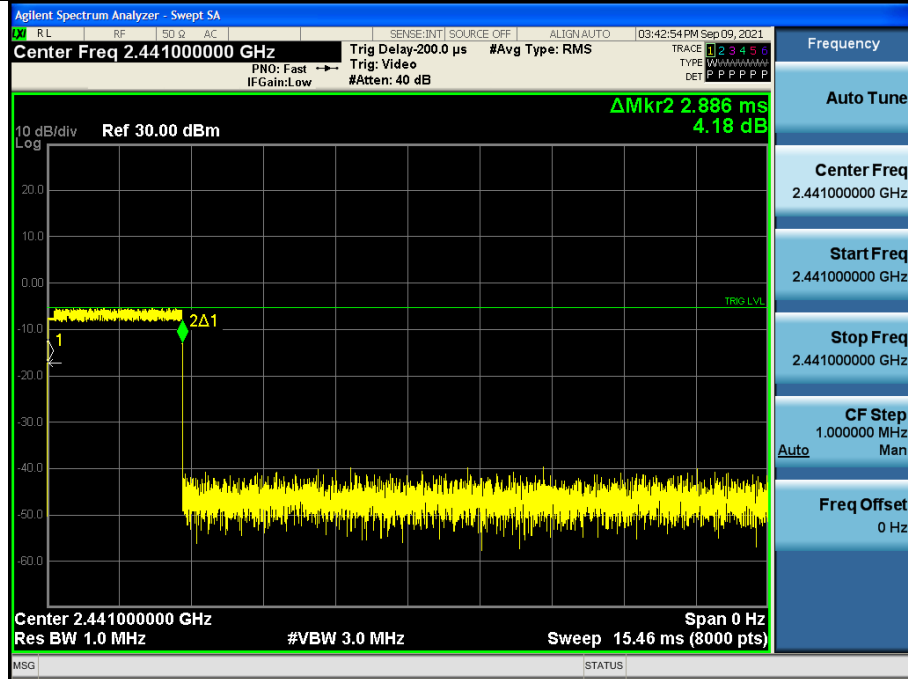



Modulation mode

8DPSK mode

3-DH1

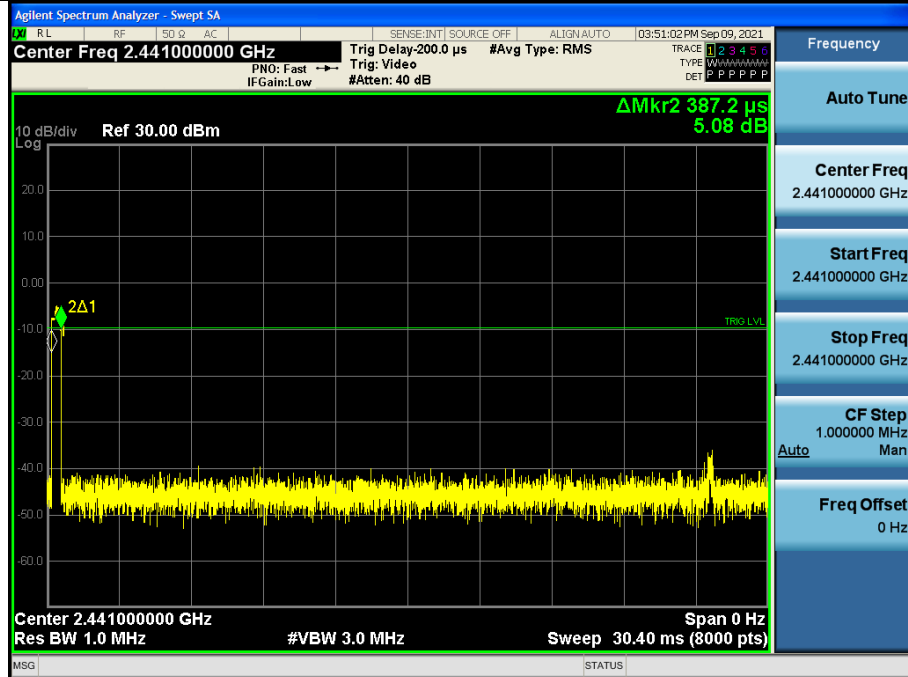

3-DH3

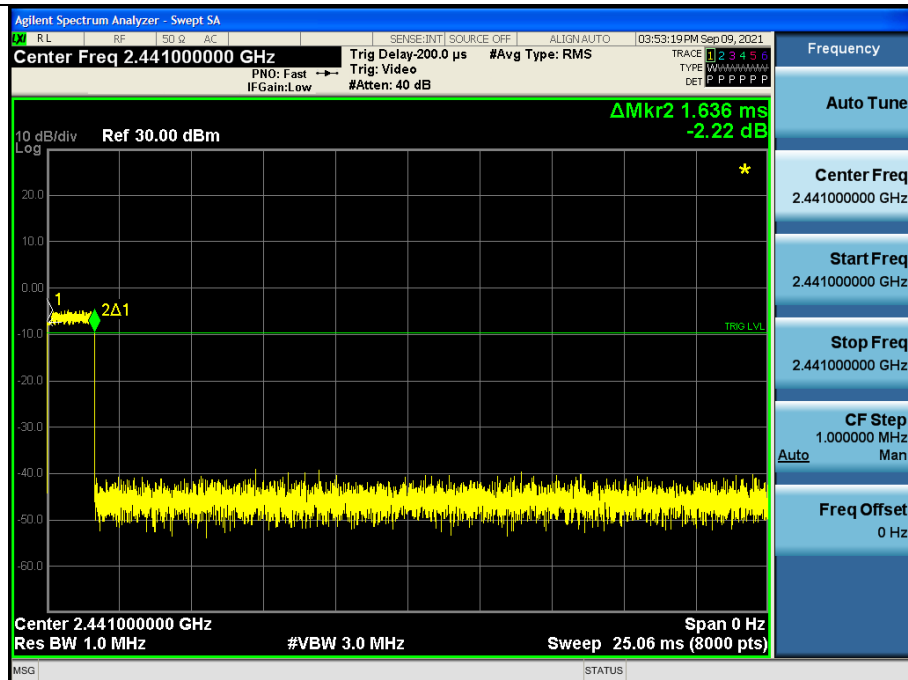



3-DH5

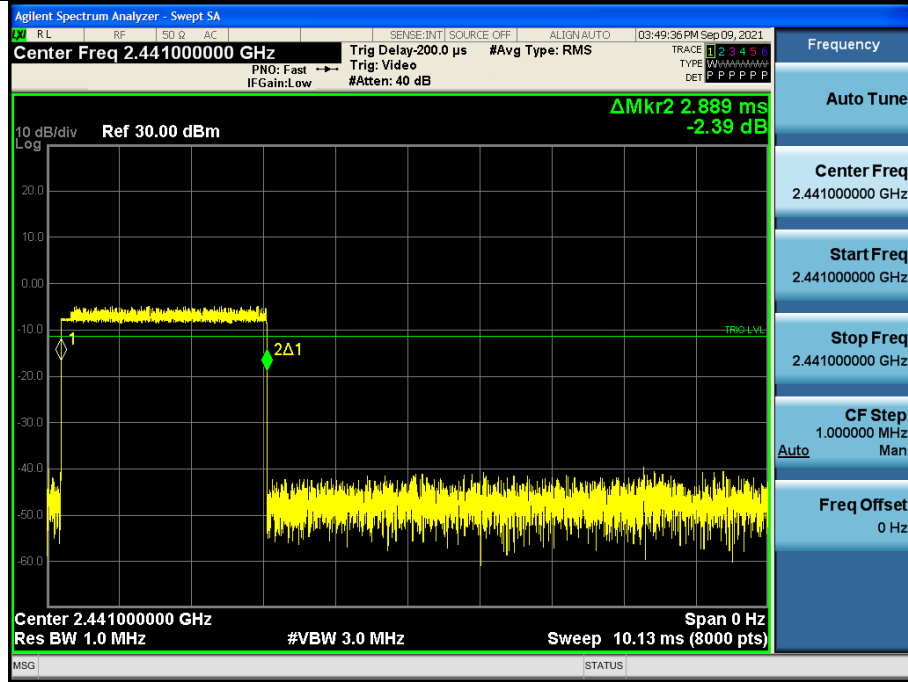

## 5.9 Conducted band edge

### 5.9.1 Limit

In any 100 kHz bandwidth outside the frequency band in which the spread spectrum or digitally modulated intentional radiator is operating, the radio frequency power that is produced by the intentional radiator shall be at least 20 dB below that in the 100 kHz bandwidth within the band that contains the highest level of the desired power, based on either an RF conducted or a radiated measurement, provided the transmitter demonstrates compliance with the peak conducted power limits. If the transmitter complies with the conducted power limits based on the use of RMS averaging over a time interval, as permitted under paragraph (b)(3) of this section, the attenuation required under this paragraph shall be 30 dB instead of 20 dB. Attenuation below the general limits specified in §15.209(a) is not required. In addition, radiated emissions which fall in the restricted bands, as defined in §15.205(a), must also comply with the radiated emission limits specified in §15.209(a) (see §15.205(c)).

### 5.9.2 Test setup

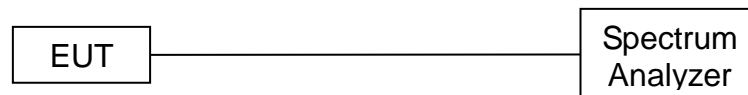

### 5.9.3 Test procedure

- a) Check the calibration of the measuring instrument using either an internal calibrator or a known signal from an external generator.
- b) Position the EUT without connection to measurement instrument. Turn on the EUT and connect its antenna terminal to measurement instrument via a low loss cable. Then set it to any one measured frequency within its operating range, and make sure the instrument is operated in its linear range.
- c) Set RBW to 100 kHz and VBW of spectrum analyzer to 300 kHz with a convenient frequency span including 100 kHz bandwidth from band edge.
- d) Measure the highest amplitude appearing on spectral display and set it as a reference level. Plot the graph with marking the highest point and edge frequency.
- e) Repeat above procedures until all measured frequencies were complete.

### 5.9.4 Test results



Test data

EUT:	Bluetooth Adapter	Model Name:	H6 Bluetooth transmitter
Pressure:	1012 hPa	Test Voltage:	DC 5V

Test plots

GFSK: Band Edge, Left Side

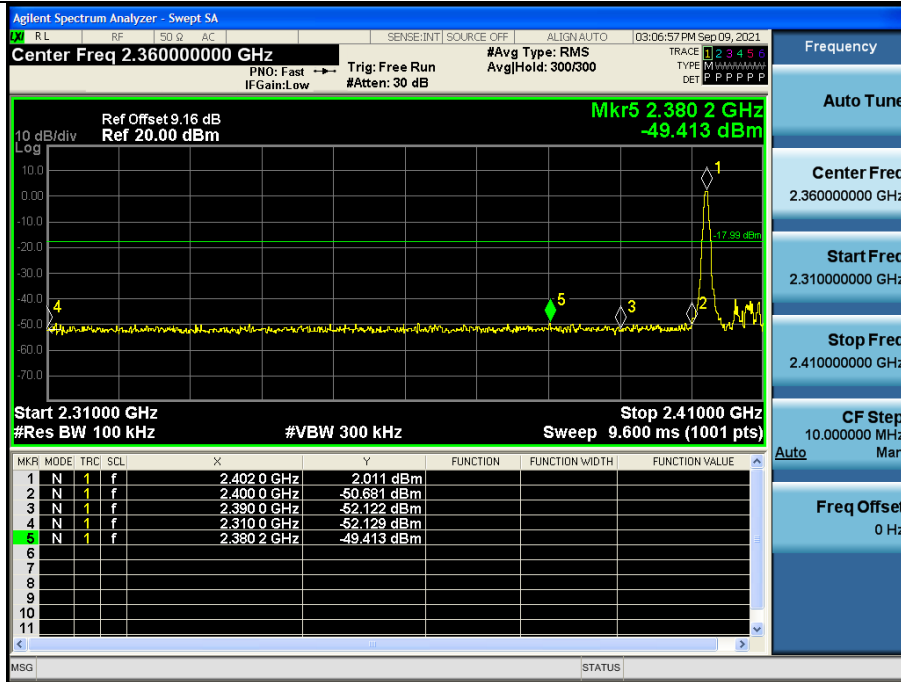

GFSK: Band Edge, Right Side

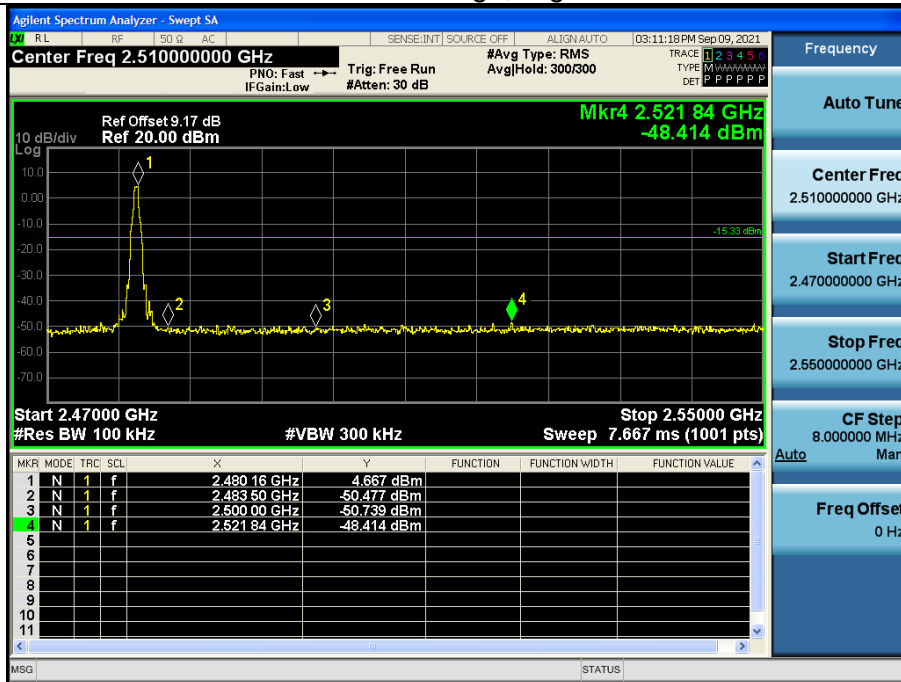



$\pi/4$ -DQPSK: Band Edge, Left Side

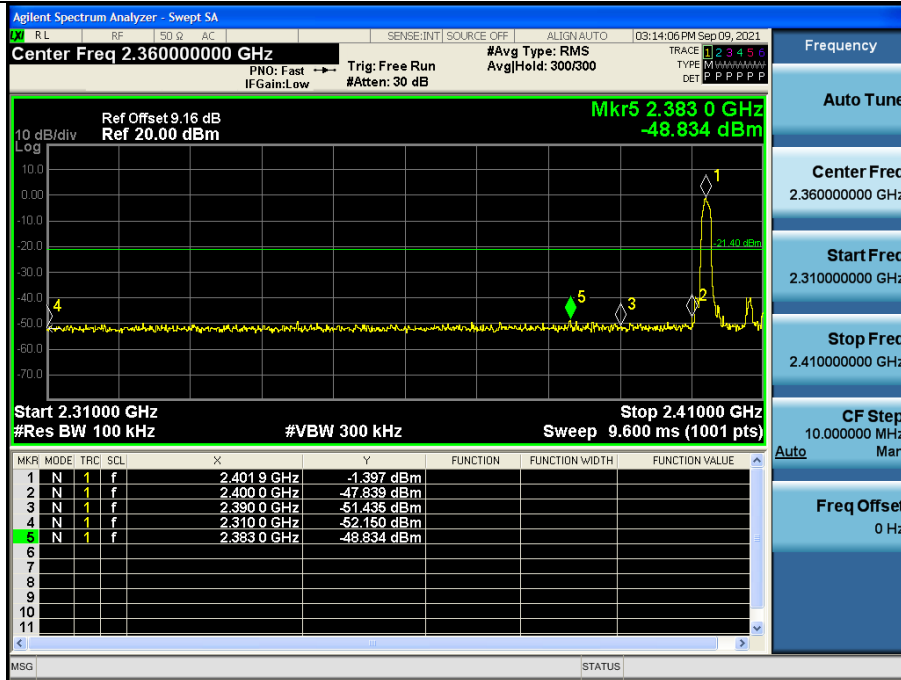

$\pi/4$ -DQPSK: Band Edge, Right Side

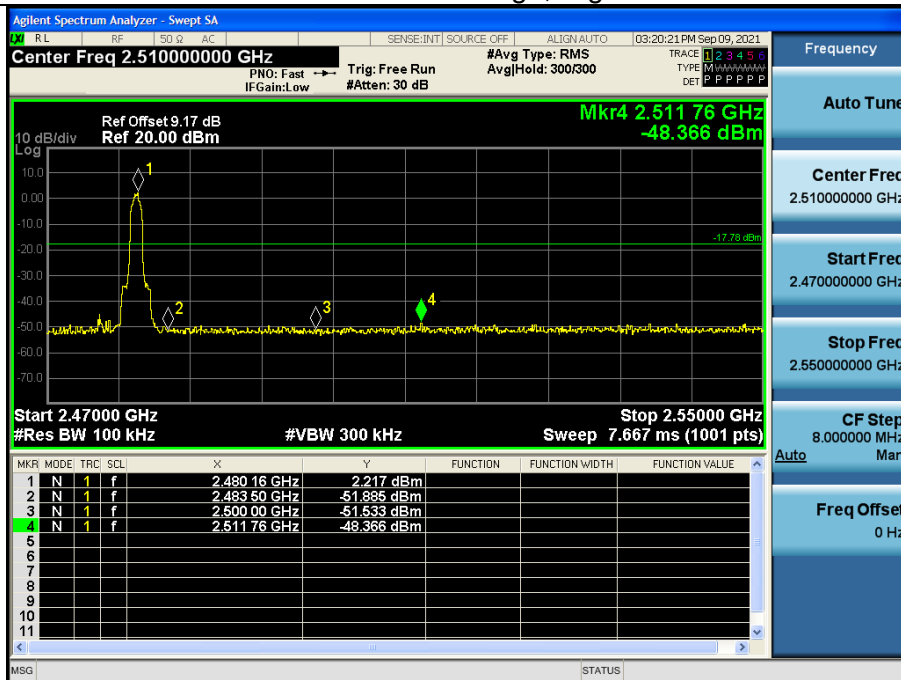



### 8DPSK: Band Edge, Left Side

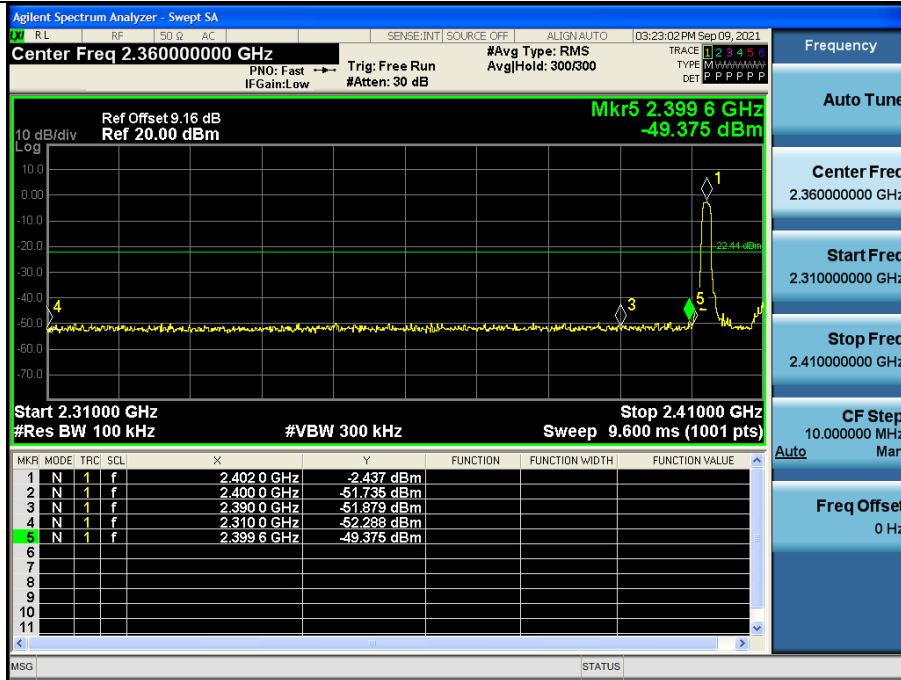

### 8DPSK: Band Edge, Right Side

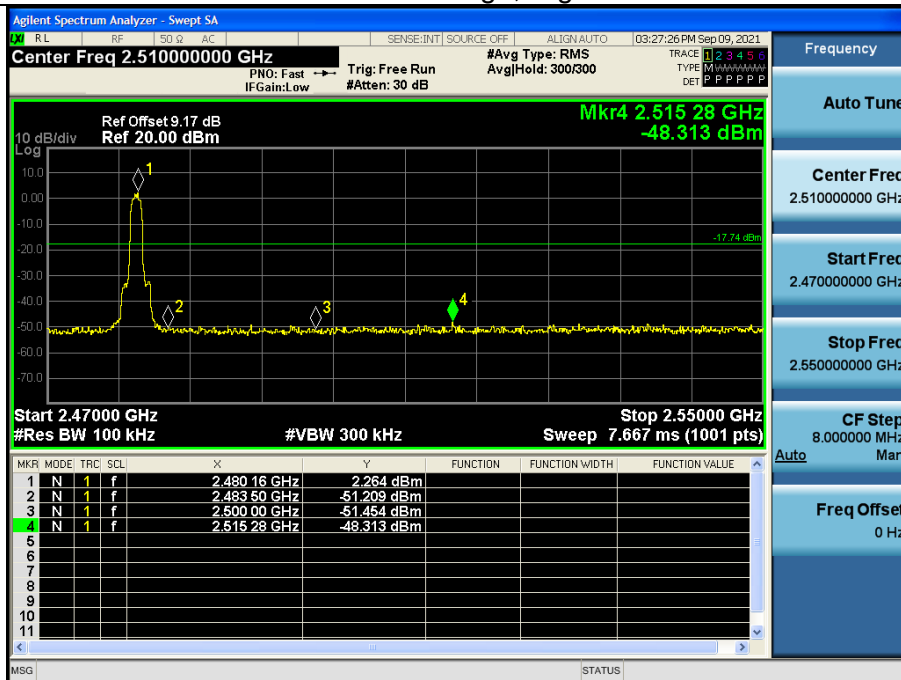



Hopping Mode  
Test plots

GFSK: Band Edge, Left Side

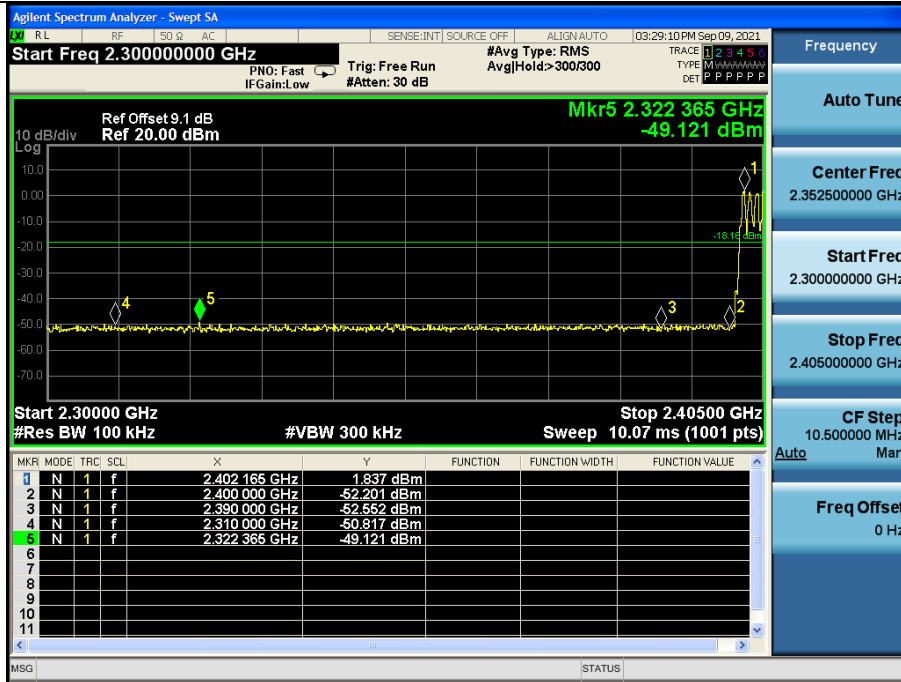

GFSK: Band Edge, Right Side

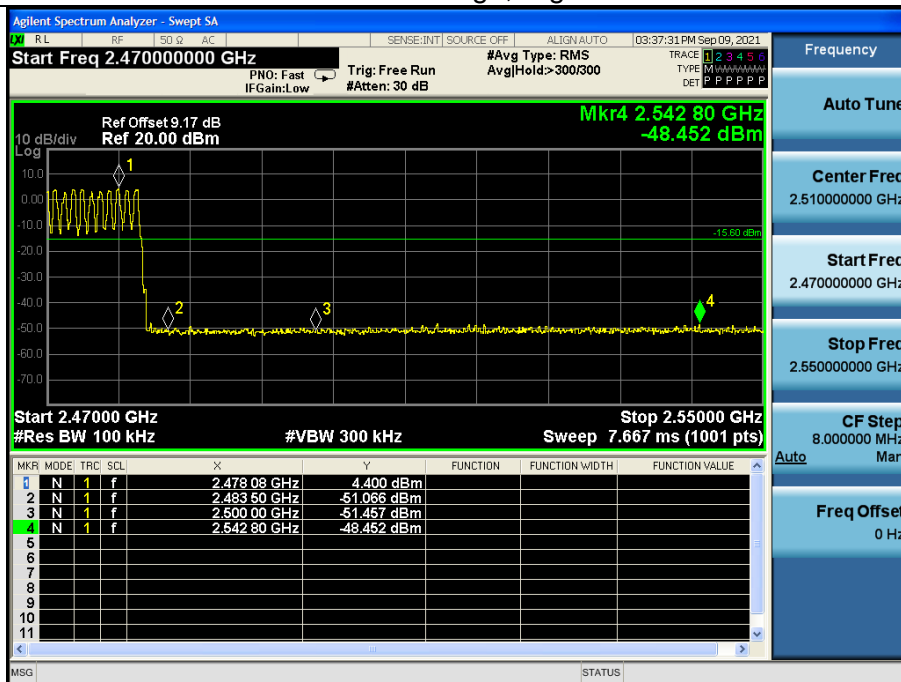





$\pi/4$ -DQPSK: Band Edge, Left Side

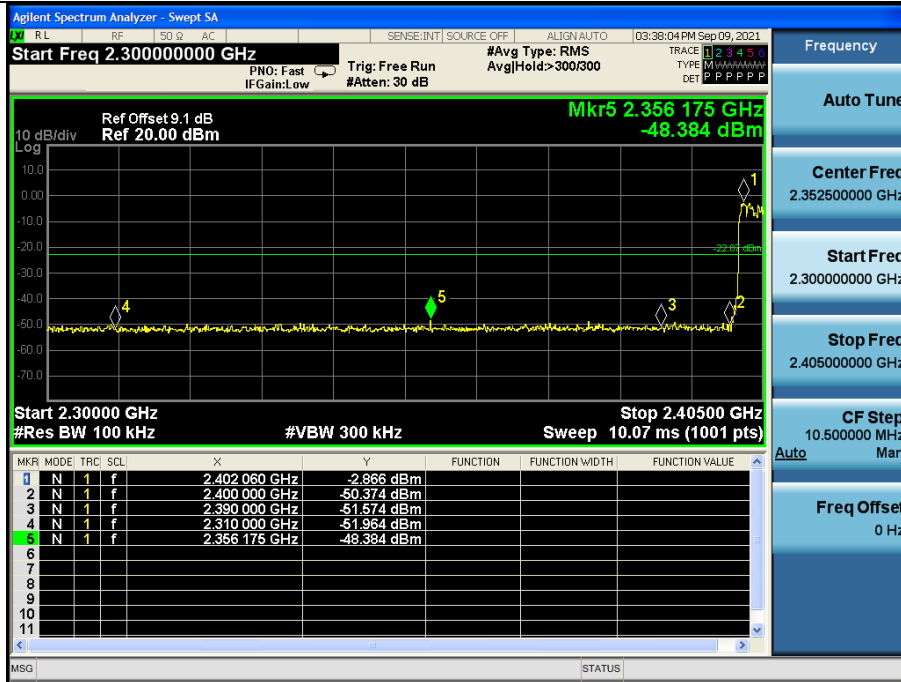

$\pi/4$ -DQPSK Band Edge, Right Side

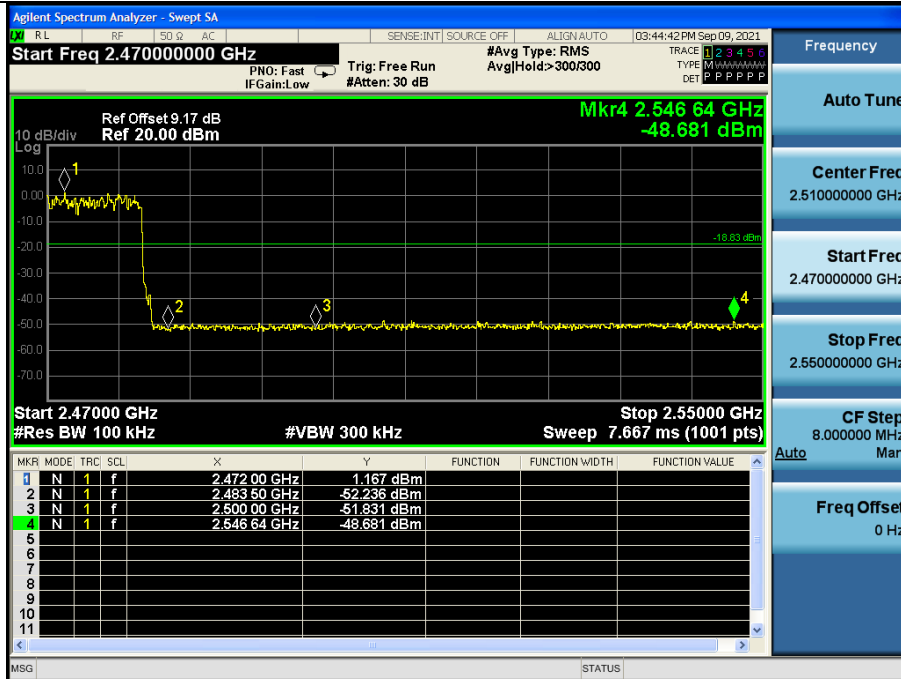



### 8DPSK: Band Edge, Left Side

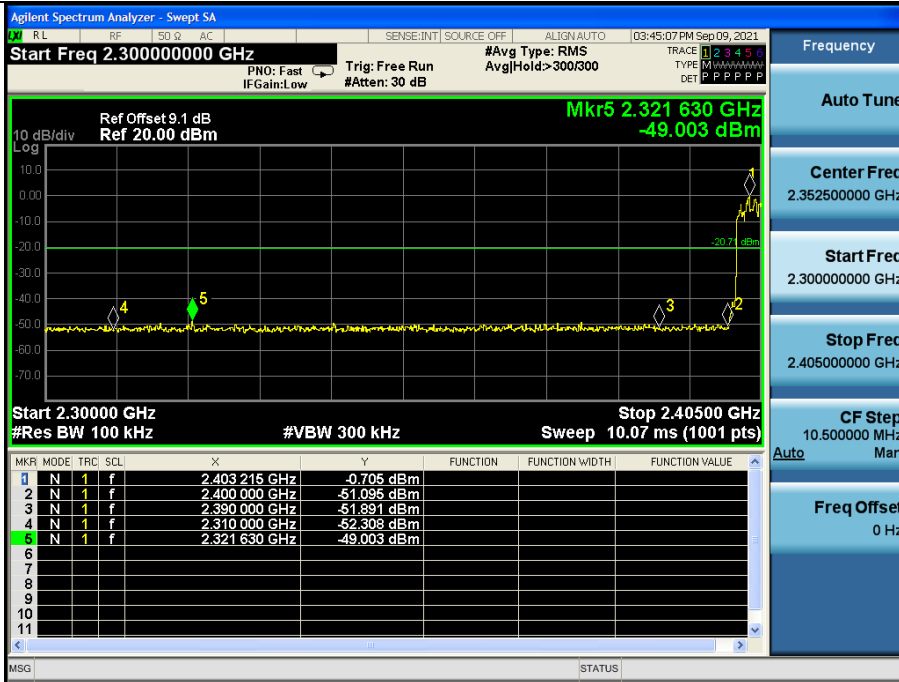

### 8DPSK Band Edge, Right Side

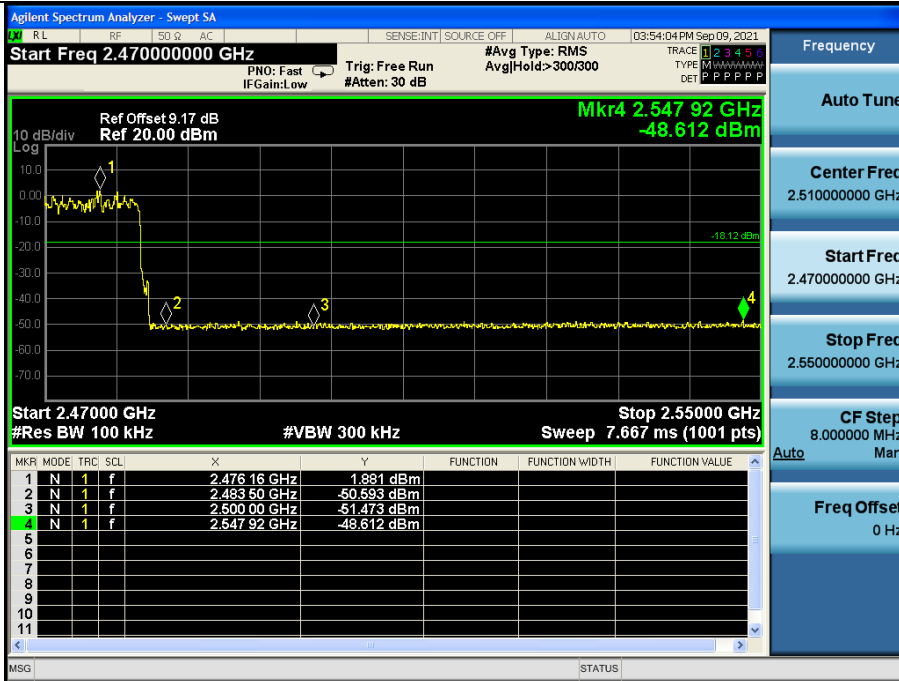

## 5.10 Spurious RF Conducted Emissions

### 5.10.1 Limit

Below -20dB of the highest emission level in operating band.

### 5.10.2 Measuring instruments

The Measuring equipment is listed in the section 4 of this test report.

### 5.10.3 Test setup

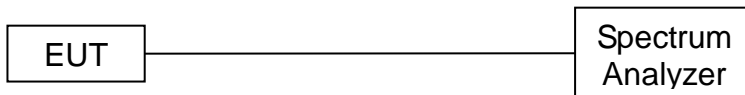

### 5.10.4 Test procedure

The Spurious RF conducted emissions compliance of RF radiated emission should be measured by following the guidance in ANSI C63.10-2013 with respect to maximizing the emission by rotating the EUT, measuring the emission while the EUT is situated in three orthogonal planes (if appropriate), adjusting the measurement antenna height and polarization etc. Set RBW=100kHz and VBW= 300kHz to measure the peak field strength, and measure frequency range from 9kHz to 26.5GHz.

### 5.10.5 Test results

Note:

- 1: The measurement frequency range is from 9kHz to the 10th harmonic of the fundamental frequency. The lowest, middle and highest channels are tested to verify the spurious emissions and band edge measurement data.
- 2: The worst mode is 8DPSK mode, and the report only show the worst mode data.



8DPSK on Channel 00



8DPSK on Channel 00

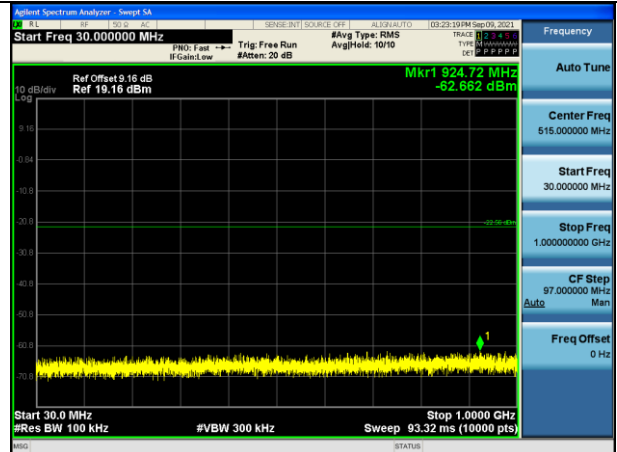

8DPSK on Channel 00

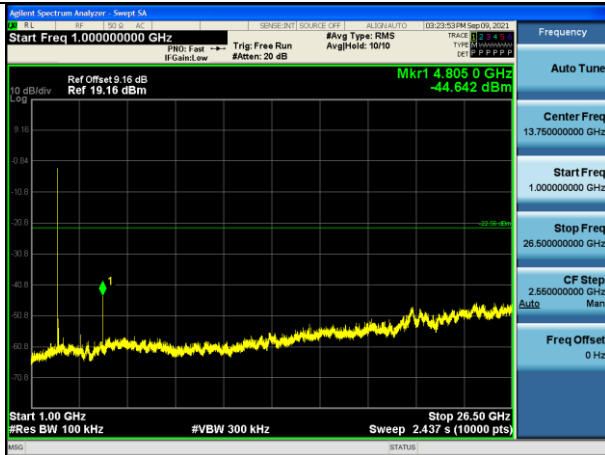

8DPSK on Channel 39



8DPSK on Channel 39

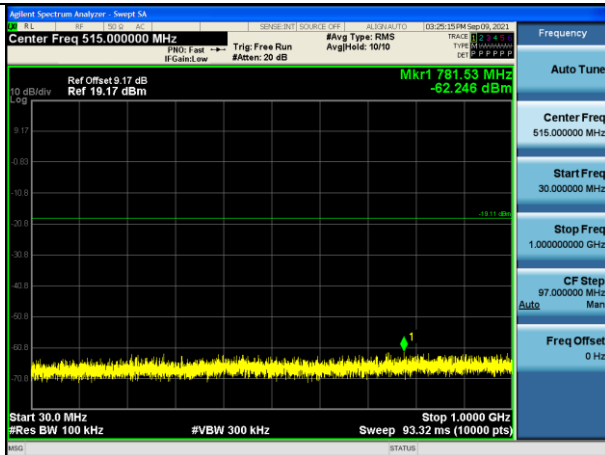

8DPSK on Channel 39

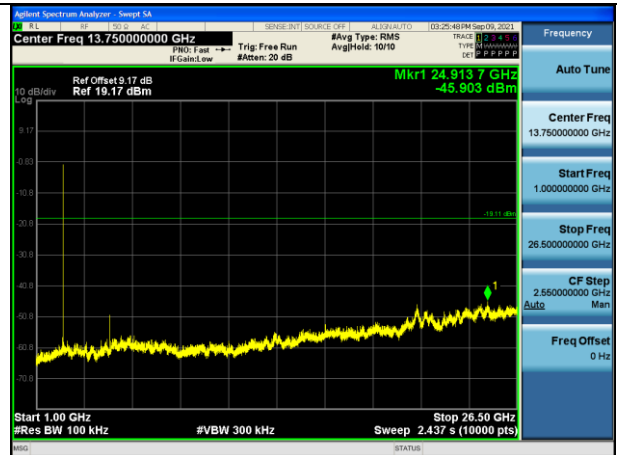



### 8DPSK on Channel 78

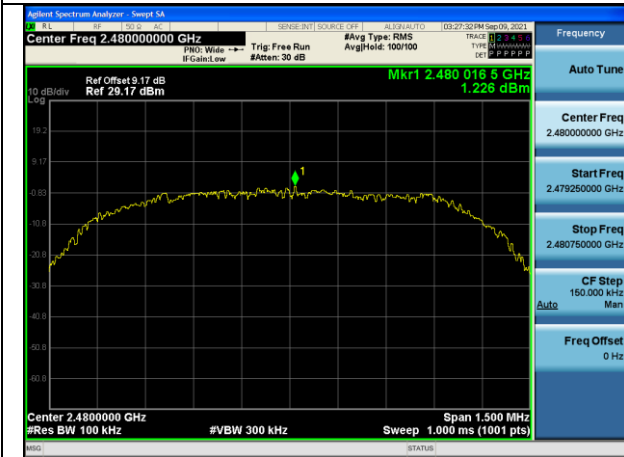

### 8DPSK on Channel 78

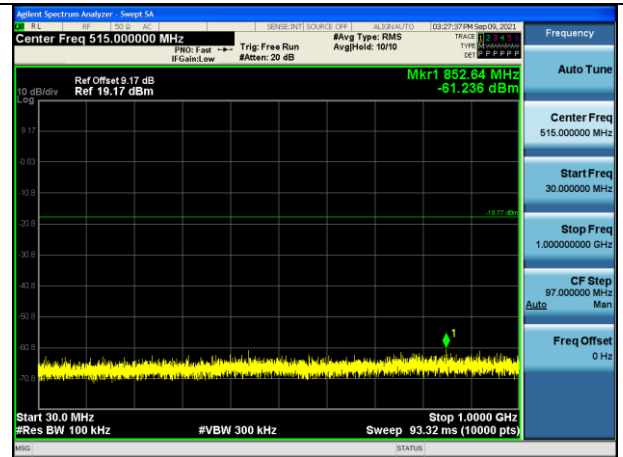

### 8DPSK on Channel 78

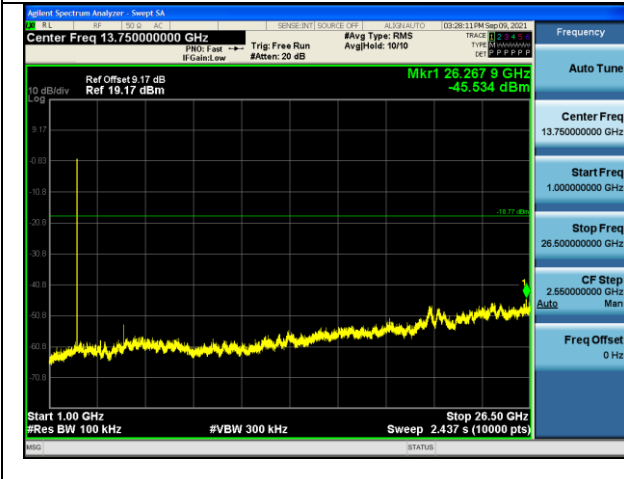

## Photographs of the Test Setup

Radiated emission

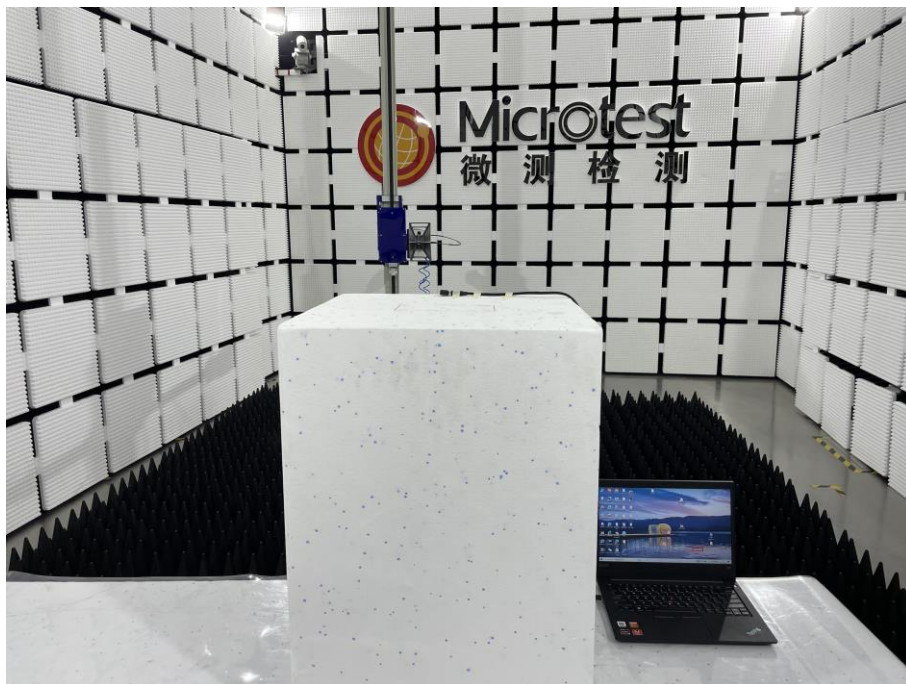



## **Photographs of the EUT**

See the APPENDIX 1- EUT PHOTO.

**----END OF REPORT----**