

RF TEST REPORT

Applicant	Tag-N-Trac Inc.
FCC ID	2A24I-V07G0BJ17
Product	SmartSense Label
Brand	Tag-N-Trac Inc.
Model	SSL300
Report No.	R2306A0684-R8
Issue Date	August 18, 2023

TA Technology (Shanghai) Co., Ltd. tested the above equipment in accordance with the requirements in **FCC CFR47 Part 15C (2022)**. The test results show that the equipment tested is capable of demonstrating compliance with the requirements as documented in this report.

Prepared by: Xu Ying

Approved by: Xu Kai

TA Technology (Shanghai) Co., Ltd.

Building 3, No.145, Jintang Rd, Pudong Shanghai, P.R.China

TEL: +86-021-50791141/2/3

FAX: +86-021-50791141/2/3-8000

TABLE OF CONTENT

1.	Test Laboratory	4
1.1.	Notes of the Test Report	4
1.2.	Test Facility	4
1.3.	Testing Location	4
2.	General Description of Equipment Under Test	5
2.1.	Applicant and Manufacturer Information	5
2.2.	General Information	5
3.	Applied Standards	6
4.	Test Configuration	7
5.	Test Case Results	8
5.1.	Unwanted Emission	8
5.2.	Conducted Emission	49
6.	Main Test Instruments	54
	ANNEX A: The EUT Appearance	55
	ANNEX B: Test Setup Photos	56

Summary of Measurement Results

Number	Test Case	Clause in FCC rules	Verdict
1	Unwanted Emissions	15.247(d),15.205,15.209	PASS
2	Conducted Emissions	15.207	PASS
Date of Testing: June 20, 2023 ~ July 28, 2023			
Date of Sample Received: June 15, 2023			
Note: All indications of Pass/Fail in this report are opinions expressed by TA Technology (Shanghai) Co., Ltd. based on interpretations and/or observations of test results. Measurement Uncertainties were not taken into account and are published for informational purposes only.			

Only Unwanted Emissions and Conducted Emissions is tested for SSL300 in this report. Other test items refer to the Module report (Report No.: R2103A0270-R1V2, FCC ID: 2AC7Z-ESPC3MINI1).

1. Test Laboratory

1.1. Notes of the Test Report

This report shall not be reproduced in full or partial, without the written approval of **TA Technology (Shanghai) Co., Ltd.** The results documented in this report apply only to the tested sample, under the conditions and modes of operation as described herein. Measurement Uncertainties were not taken into account and are published for informational purposes only. This report is written to support regulatory compliance of the applicable standards stated above.

1.2. Test Facility

FCC (Designation number: CN1179, Test Firm Registration Number: 446626)

TA Technology (Shanghai) Co., Ltd. has been listed on the US Federal Communications Commission list of test facilities recognized to perform measurements.

A2LA (Certificate Number: 3857.01)

TA Technology (Shanghai) Co., Ltd. has been listed by American Association for Laboratory Accreditation to perform measurement.

1.3. Testing Location

Company: TA Technology (Shanghai) Co., Ltd.
 Address: Building 3, No.145, Jintang Rd, Pudong Shanghai, P.R.China
 City: Shanghai
 Post code: 201201
 Country: P. R. China
 Contact: Xu Kai
 Telephone: +86-021-50791141/2/3
 Fax: +86-021-50791141/2/3-8000
 Website: <http://www.ta-shanghai.com>
 E-mail: xukai@ta-shanghai.com

2. General Description of Equipment Under Test

2.1. Applicant and Manufacturer Information

Applicant	Tag-N-Trac Inc.
Applicant address	4250 Executive Sq, #675, La Jolla, California, United States, 92037
Manufacturer	Tag-N-Trac Inc.
Manufacturer address	4250 Executive Sq, #675, La Jolla, California, United States, 92037

2.2. General Information

EUT Description	
Model	SSL300
IMEI	868617060225648
Hardware Version	V1.1
Software Version	IRONHIDE_00_11_LO
Power Supply	Battery / External power supply
Antenna Type	PCB Antenna
Antenna Connector	A permanently attached antenna (meet with the standard FCC Part 15.203 requirement)
Antenna Gain	1.05 dBi
Additional Beamforming Gain	NA
Operating Frequency Range(s)	802.11b/g/n(HT20): 2412 ~ 2462 MHz 802.11n(HT40): 2422 ~ 2452 MHz Bluetooth LE V5.0 : 2402 ~2480 MHz
Modulation Type	802.11b: DSSS 802.11g/n(HT20/HT40): OFDM Bluetooth LE: GFSK
EUT Accessory	
Battery	Manufacturer: Shenzhen Yabo Power Technology Co., Ltd Mode: LP 218880 DC 3.7V, 1600mAh
Note: 1. The EUT is sent from the applicant to TA and the information of the EUT is declared by the applicant.	

3. Applied Standards

According to the specifications of the manufacturer, it must comply with the requirements of the following standards:

Test standards:

FCC CFR47 Part 15C (2022) Radio Frequency Devices

ANSI C63.10-2013

Reference standard:

KDB 558074 D01 15.247 Meas Guidance v05r02

4. Test Configuration

Test Mode

The EUT has been associated with peripherals and configuration operated in a manner tended to maximize its emission characteristics in a typical application.

The radiated emission was measured in the following position: EUT stand-up position (Z axis), lie-down position (X, Y axis). The worst emission was found in lie-down position (X axis) and the loop antenna is vertical, the others are vertical and horizontal. and the worst case was recorded.

In order to find the worst case condition, Pre-tests are needed at the presence of different data rate. Preliminary tests have been done on all the configuration for confirming worst case. Data rate below means worst-case rate of each test item.

Worst-case data rates are shown as following table.

Test Mode	Data Rate
Bluetooth(Low Energy)	1Mbps, 2Mbps
802.11b	1 Mbps
802.11g	6 Mbps
802.11n HT20	MCS0
802.11n HT40	MCS0

5. Test Case Results

5.1. Unwanted Emission

Ambient Condition

Temperature	Relative humidity
20°C ~ 25°C	45% ~ 50%

Method of Measurement

The test set-up was made in accordance to the general provisions of ANSI C63.10.

The Equipment Under Test (EUT) was set up on a non-conductive table in the semi-anechoic chamber. The test was performed at the distance of 3 m between the EUT and the receiving antenna.

The turntable shall be rotated from 0 to 360 degrees for detecting the maximum of radiated spurious signal level. The measurements shall be repeated with orthogonal polarization of the test antenna. The data of cable loss and antenna factor has been calibrated in full testing frequency range before the testing. Sweep the Restricted Band and the emissions less than 20 dB below the permissible value are reported.

The radiated emissions measurements were made in a typical installation configuration.

Sweep the whole frequency band through the range from 9 kHz to the 10th harmonic of the carrier, and the emissions less than 20 dB below the permissible value are reported.

This method refer to ANSI C63.10.

The procedure for peak unwanted emissions measurements above 1000 MHz is as follows:

Set the spectrum analyzer in the following:

9kHz~150 kHz

RBW=200Hz, VBW=1kHz/ Sweep=AUTO

150 kHz~30MHz

RBW=9KHz, VBW=30KHz,/ Sweep=AUTO

Below 1GHz

RBW=100kHz / VBW=300kHz / Sweep=AUTO

a) Peak emission levels are measured by setting the instrument as follows:

Above 1GHz

PEAK: RBW=1MHz VBW=3MHz/ Sweep=AUTO

b) Average emission levels are measured by setting the instrument as follows:

Above 1GHz

AVERAGE: RBW=1MHz / VBW=3MHz / Sweep=AUTO

c) Detector: The measurements employing a CISPR quasi-peak detector except for the frequency bands 9-90 kHz, 110-490 kHz and above 1000 MHz. Radiated emission limits in these three bands

are based on measurements employing an average detector.

d) Averaging type = power (i.e., rms) (As an alternative, the detector and averaging type may be set for linear voltage averaging. Some instruments require linear display mode to use linear voltage averaging. Log or dB averaging shall not be used.)

e) Sweep time = auto.

f) Perform a trace average of at least 100 traces if the transmission is continuous. If the transmission is not continuous, then the number of traces shall be increased by a factor of $1 / D$, where D is the duty cycle. For example, with 50% duty cycle, at least 200 traces shall be averaged. (If a specific emission is demonstrated to be continuous—i.e., 100% duty cycle—then rather than turning ON and OFF with the transmit cycle, at least 100 traces shall be averaged.)

g) If tests are performed with the EUT transmitting at a duty cycle less than 98%, then a correction factor shall be added to the measurement results prior to comparing with the emission limit, to compute the emission level that would have been measured had the test been performed at 100% duty cycle. The correction factor is computed as follows:

1) If power averaging (rms) mode was used in the preceding step e), then the correction factor is $[10 \log (1 / D)]$, where D is the duty cycle. For example, if the transmit duty cycle was 50%, then 3 dB shall be added to the measured emission levels.

2) If linear voltage averaging mode was used in the preceding step e), then the correction factor is $[20 \log (1 / D)]$, where D is the duty cycle. For example, if the transmit duty cycle was 50%, then 6 dB shall be added to the measured emission levels.

3) If a specific emission is demonstrated to be continuous (100% duty cycle) rather than turning ON and OFF with the transmit cycle, then no duty cycle correction is required for that emission.

The test is in transmitting mode.

Test Setup

9KHz~ 30MHz

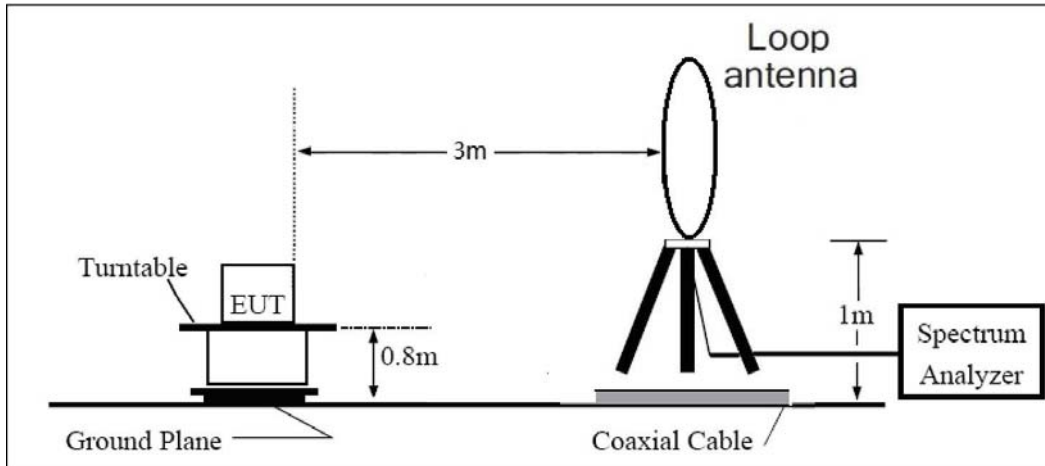

30MHz~ 1GHz

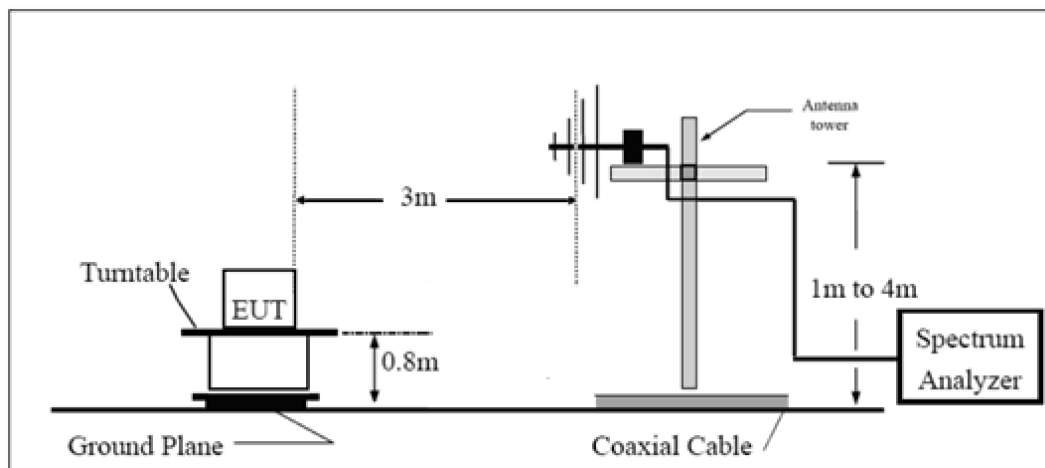

Above 1GHz

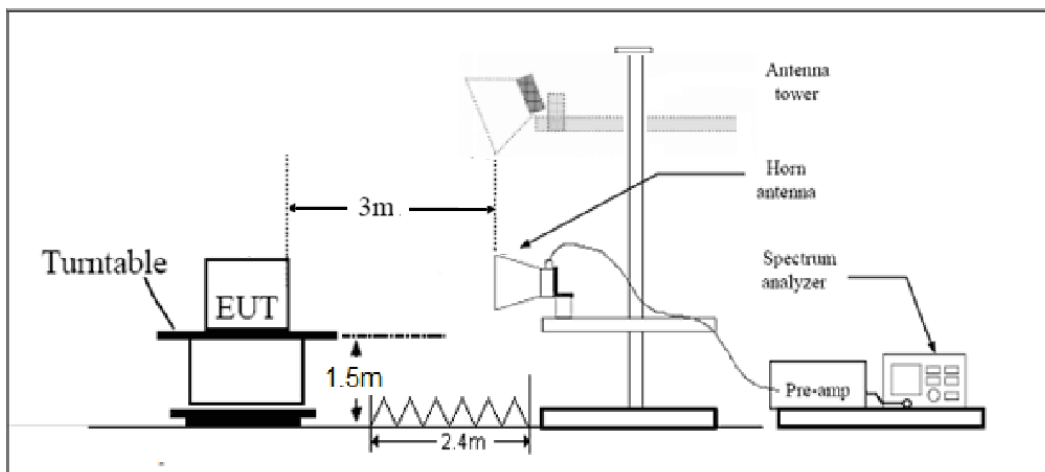

Note: Area side:2.4mX3.6m

Limits

Rule Part 15.247(d) specifies that “In addition, radiated emissions which fall in the restricted bands, as defined in § 15.205(a), must also comply with the radiated emission limits specified in § 15.209(a) (see § 15.205(c)).”

Limit in restricted band

Frequency of emission (MHz)	Field strength($\mu\text{V}/\text{m}$)	Field strength($\text{dB}\mu\text{V}/\text{m}$)
0.009–0.490	2400/F(kHz)	/
0.490–1.705	24000/F(kHz)	/
1.705–30.0	30	/
30-88	100	40
88-216	150	43.5
216-960	200	46
Above960	500	54

§15.35(b)

There is also a limit on the radio frequency emissions, as measured using instrumentation with a peak detector function, corresponding to 20 dB above the maximum permitted average limit.

Peak Limit=74 $\text{dB}\mu\text{V}/\text{m}$

Average Limit=54 $\text{dB}\mu\text{V}/\text{m}$

Spurious Radiated Emissions are permitted in any of the frequency bands listed below:

MHz	MHz	MHz	GHz
0.090-0.110	16.42-16.423	399.9-410	4.5-5.15
¹ 0.495-0.505	16.69475-16.69525	608-614	5.35-5.46
2.1735-2.1905	16.80425-16.80475	960-1240	7.25-7.75
4.125-4.128	25.5-25.67	1300-1427	8.025-8.5
4.17725-4.17775	37.5-38.25	1435-1626.5	9.0-9.2
4.20725-4.20775	73-74.6	1645.5-1646.5	9.3-9.5
6.215-6.218	74.8-75.2	1660-1710	10.6-12.7
6.26775-6.26825	108-121.94	1718.8-1722.2	13.25-13.4
6.31175-6.31225	123-138	2200-2300	14.47-14.5
8.291-8.294	149.9-150.05	2310-2390	15.35-16.2
8.362-8.366	156.52475-156.52525	2483.5-2500	17.7-21.4
8.37625-8.38675	156.7-156.9	2690-2900	22.01-23.12
8.41425-8.41475	162.0125-167.17	3260-3267	23.6-24.0
12.29-12.293	167.72-173.2	3332-3339	31.2-31.8
12.51975-12.52025	240-285	3345.8-3358	36.43-36.5
12.57675-12.57725	322-335.4	3600-4400	(²)
13.36-13.41			

Measurement Uncertainty

The assessed measurement uncertainty to ensure 95% confidence level for the normal distribution is with the coverage factor $k = 1.96$.

Frequency	Uncertainty
9KHz-30MHz	3.55 dB
30MHz-200MHz	4.17 dB
200MHz-1GHz	4.84 dB
1-18GHz	4.35 dB
18-26.5GHz	5.90 dB
26.5GHz~40GHz	5.92 dB

Test Results:

A symbol (∇) in the test plot below means (dB μ V/m)

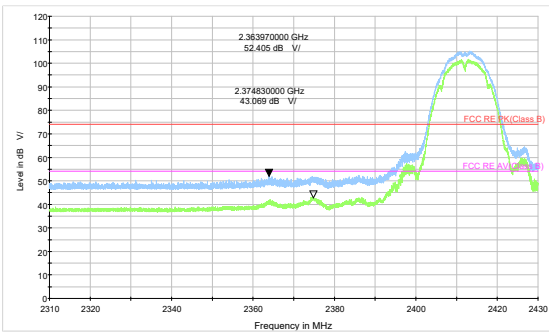

802.11b-Channel 1 Peak+ Average

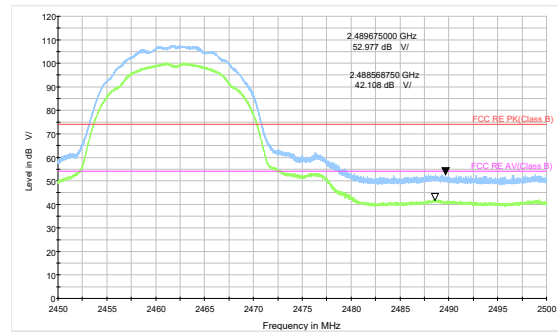

802.11b-Channel 11 Peak+ Average

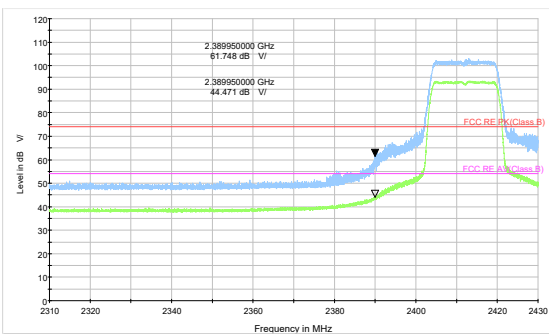

802.11g-Channel 1 Peak+ Average

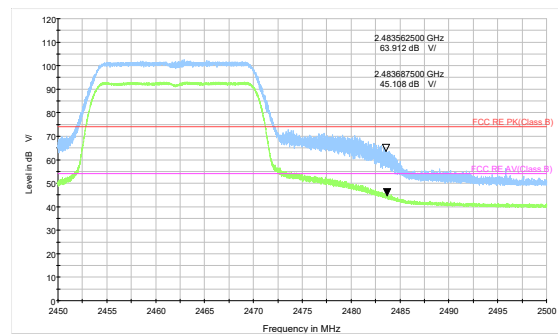

802.11g-Channel 11 Peak+ Average

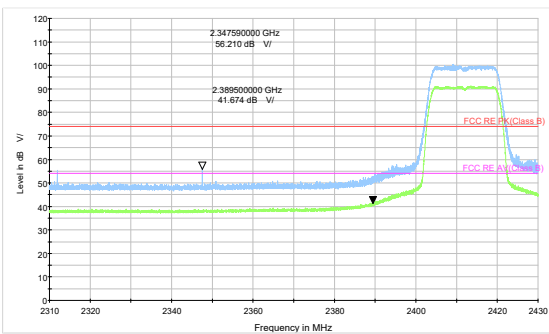

802.11n HT20 -Channel 1 Peak+ Average

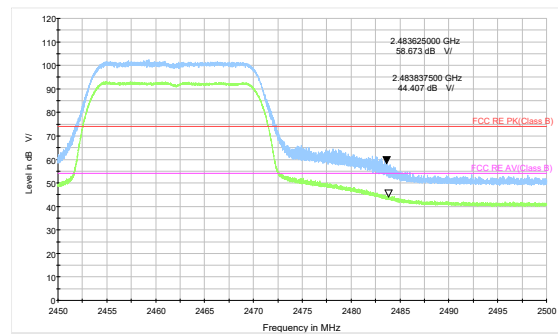

802.11n HT20 -Channel 11 Peak+ Average

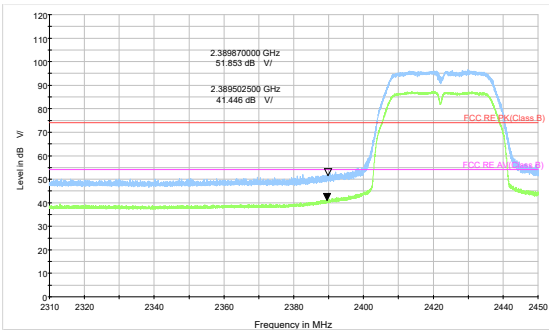

802.11n HT40 -Channel 3 Peak+ Average

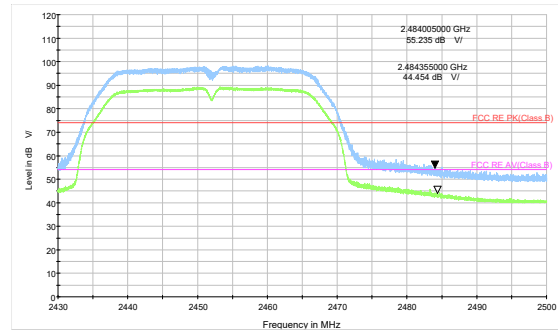

802.11n HT40 -Channel 9 Peak+ Average

After the pretest, Bluetooth LE (1M) was selected as the worst Mode for Bluetooth LE.

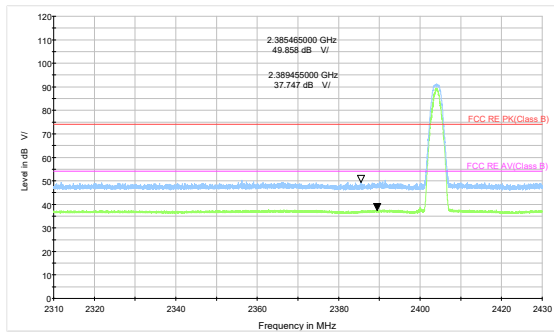

Bluetooth LE Channel 0 Peak+ Average

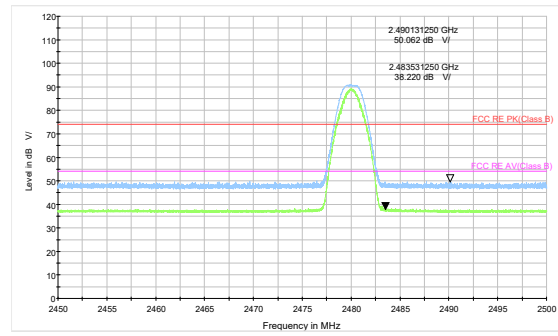

Bluetooth LE Channel 39 Peak+ Average

Result of RE

Test result

Sweep the whole frequency band through the range from 9kHz to the 10th harmonic of the carrier, the Emissions in the frequency band 9kHz-30MHz are more than 20dB below the limit are not reported.

The following graphs display the maximum values of horizontal and vertical by software. For above 1GHz, Blue trace uses the peak detection, Green trace uses the average detection.

Continuous TX mode:

Wi-Fi 2.4G

During the test, the Radiates Emission from 30MHz to 1GHz was performed in all modes with all channels, 802.11b, Channel 6 are selected as the worst condition. The test data of the worst-case condition was recorded in this report.

A symbol (dB V/) in the test plot below means (dBμV/m)

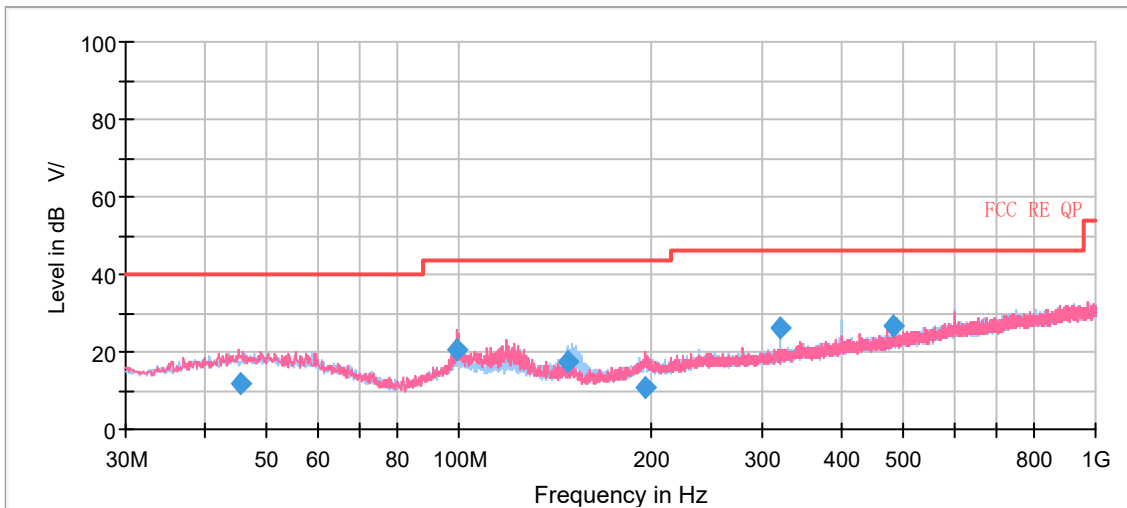

Radiates Emission from 30MHz to 1GHz

Frequency (MHz)	Quasi-Peak (dBμV/m)	Limit (dBμV/m)	Margin (dB)	Height (cm)	Polarization	Azimuth (deg)	Correct Factor (dB)
45.316250	11.63	40.00	28.37	109.0	V	144.0	20.3
99.033750	20.28	43.50	23.22	100.0	V	253.0	18.8
148.256250	17.37	43.50	26.13	225.0	H	80.0	14.7
196.151250	10.70	43.50	32.80	100.0	V	0.0	18.5
319.990000	26.16	46.00	19.84	100.0	H	158.0	20.8
479.998750	26.66	46.00	19.34	184.0	H	133.0	24.2

- Remark: 1. Correction Factor = Antenna factor + Insertion loss (cable loss + amplifier gain)
- 2. Margin = Limit – Quasi-Peak

802.11b CH1

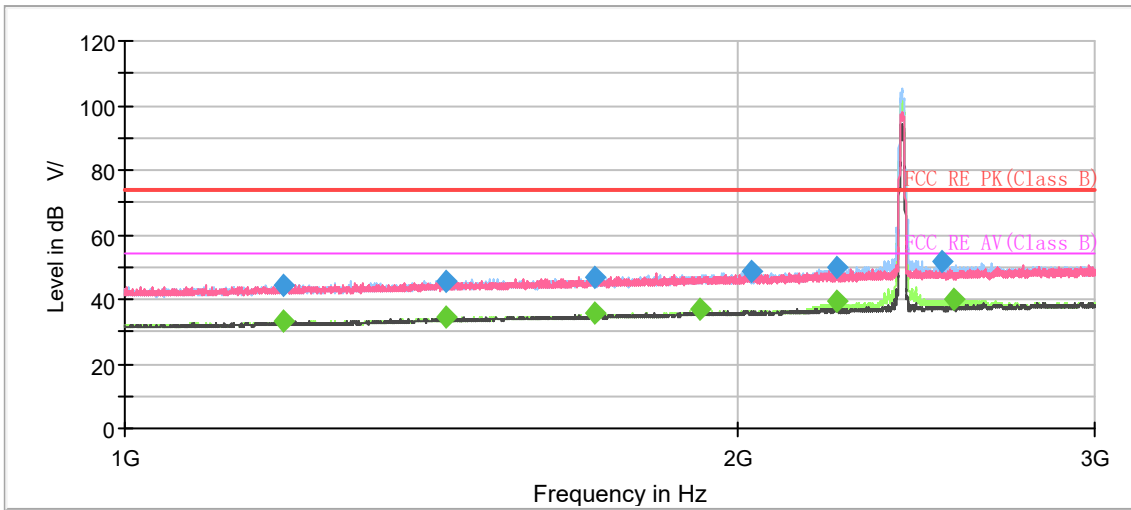

Note: The signal beyond the limit is carrier.
Radiates Emission from 1GHz to 3GHz

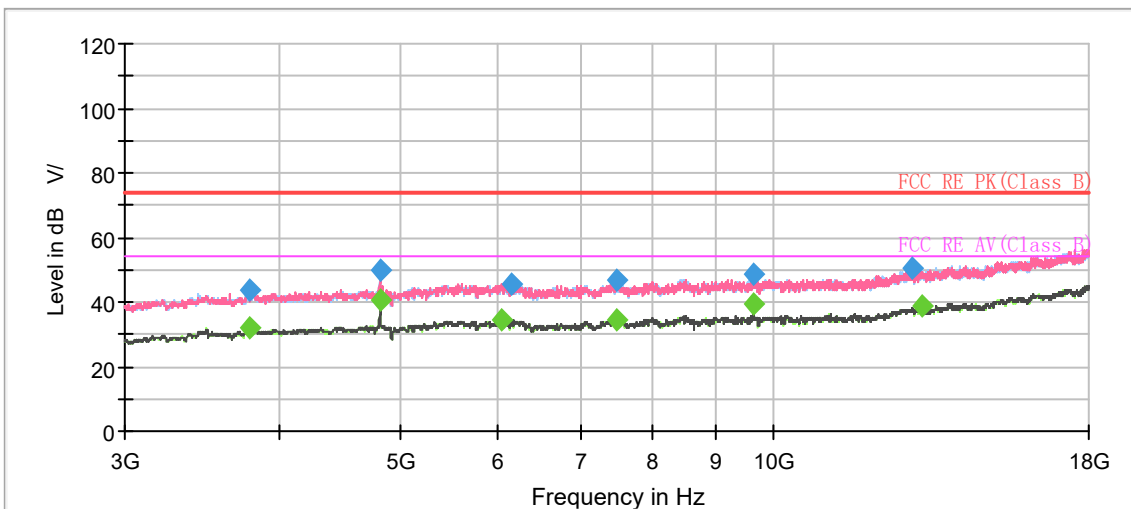

Radiates Emission from 3GHz to 18GHz

Frequency (MHz)	MaxPeak (dB μ V/m)	Average (dB μ V/m)	Limit (dB μ V/m)	Margin (dB)	Meas. Time (ms)	Height (cm)	Pol	Azimuth (deg)	Corr. (dB/m)
1197.000000	44.45	---	74.00	29.55	500.0	100.0	V	136.0	-7.1
1197.250000	---	33.03	54.00	20.97	500.0	200.0	H	103.0	-7.1
1438.250000	45.47	---	74.00	28.53	500.0	200.0	H	302.0	-5.4
1440.000000	---	34.45	54.00	19.55	500.0	200.0	H	178.0	-5.4
1703.000000	---	35.60	54.00	18.40	500.0	200.0	H	312.0	-3.8
1703.250000	46.78	---	74.00	27.22	500.0	100.0	V	32.0	-3.8
1920.500000	---	36.78	54.00	17.22	500.0	200.0	H	357.0	-2.7
2034.250000	48.44	---	74.00	25.56	500.0	200.0	V	48.0	-2.4
2240.250000	---	39.63	54.00	14.37	500.0	200.0	H	178.0	-1.4
2240.750000	49.67	---	74.00	24.33	500.0	200.0	H	191.0	-1.4
2521.500000	51.53	---	74.00	24.47	500.0	200.0	H	226.0	-0.2
2560.250000	---	39.80	54.00	14.20	500.0	200.0	H	221.0	0.0

Remark: 1. Correction Factor = Antenna factor + Insertion loss (cable loss + amplifier gain)

2. Margin = Limit - MAX Peak/ Average

802.11b CH6

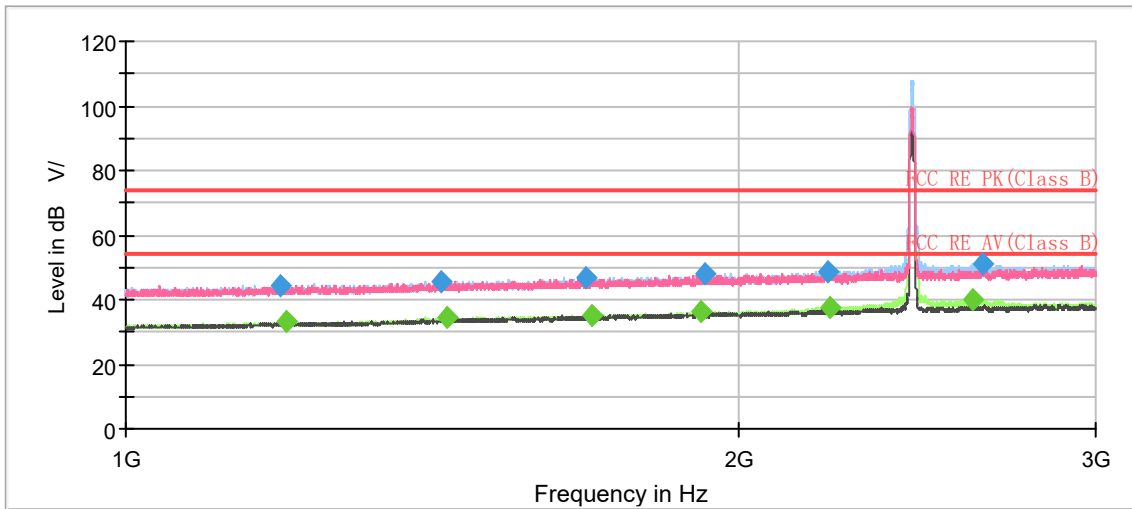

Note: The signal beyond the limit is carrier.
Radiates Emission from 1GHz to 3GHz

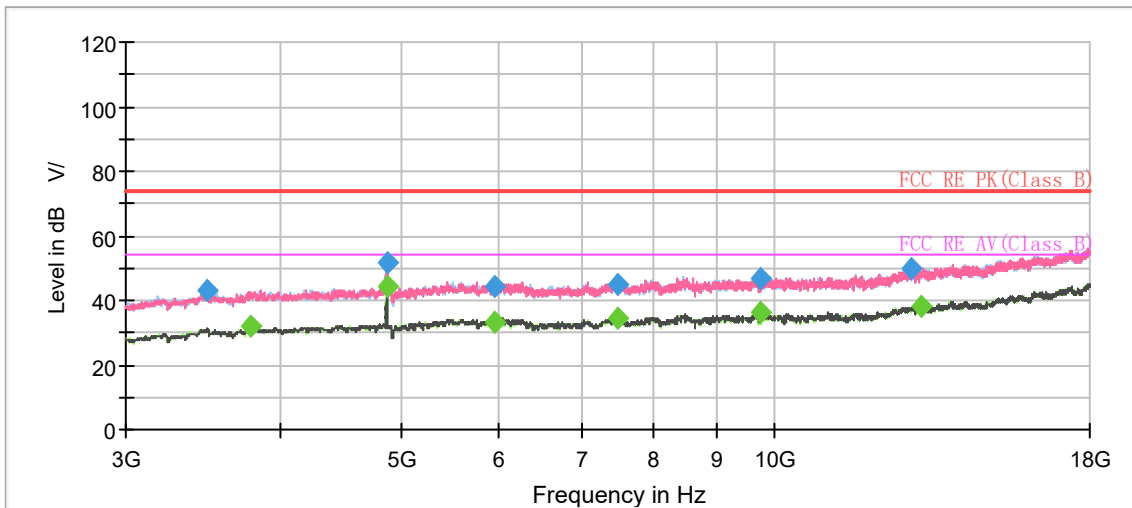

Radiates Emission from 3GHz to 18GHz

Frequency (MHz)	MaxPeak (dB μ V/m)	Average (dB μ V/m)	Limit (dB μ V/m)	Margin (dB)	Meas. Time (ms)	Height (cm)	Pol	Azimuth (deg)	Corr. (dB/m)
1190.750000	44.32	---	74.00	29.68	500.0	200.0	H	101.0	-7.1
1200.000000	---	33.06	54.00	20.94	500.0	100.0	H	80.0	-7.0
1427.750000	45.45	---	74.00	28.55	500.0	100.0	H	163.0	-5.4
1440.500000	---	34.41	54.00	19.59	500.0	100.0	H	75.0	-5.4
1683.250000	46.62	---	74.00	27.38	500.0	200.0	V	214.0	-4.0
1697.250000	---	35.14	54.00	28.86	500.0	100.0	H	117.0	-3.8
1920.250000	---	36.57	54.00	17.43	500.0	200.0	H	0.0	-2.7
1926.750000	48.17	---	74.00	25.83	500.0	100.0	V	66.0	-2.5
2216.250000	48.58	---	74.00	25.42	500.0	200.0	H	173.0	-1.4
2219.250000	---	37.60	54.00	16.40	500.0	200.0	H	168.0	-1.4
2612.250000	---	39.82	54.00	14.18	500.0	200.0	H	230.0	0.2
2641.250000	51.13	---	74.00	22.87	500.0	200.0	H	209.0	0.5
4873.125000	---	44.19	54.00	9.81	500.0	100.0	H	272.0	-2.0

Remark: 1. Correction Factor = Antenna factor + Insertion loss (cable loss + amplifier gain)

2. Margin = Limit - MAX Peak/ Average

802.11b CH11

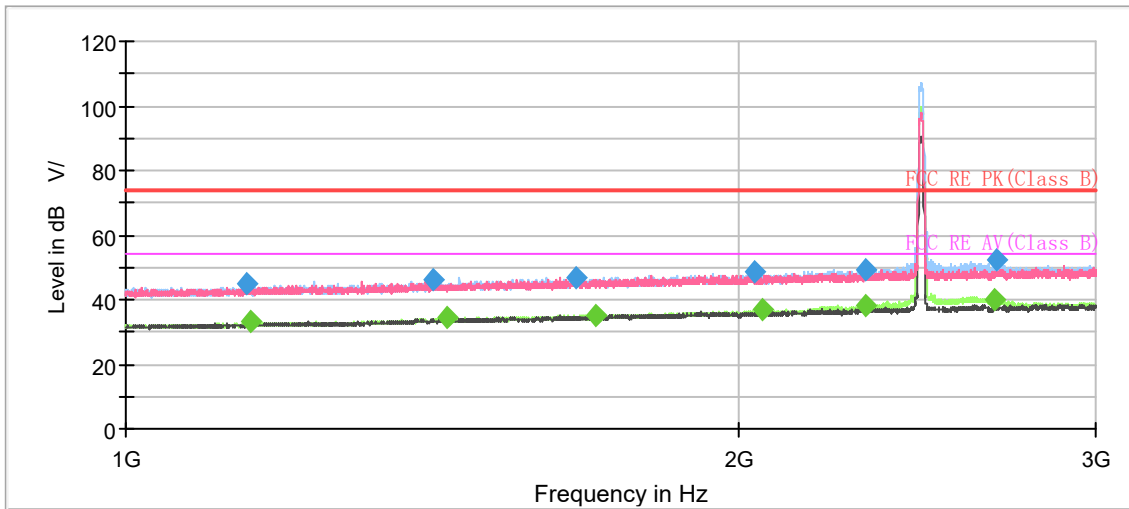

Note: The signal beyond the limit is carrier.
Radiates Emission from 1GHz to 3GHz

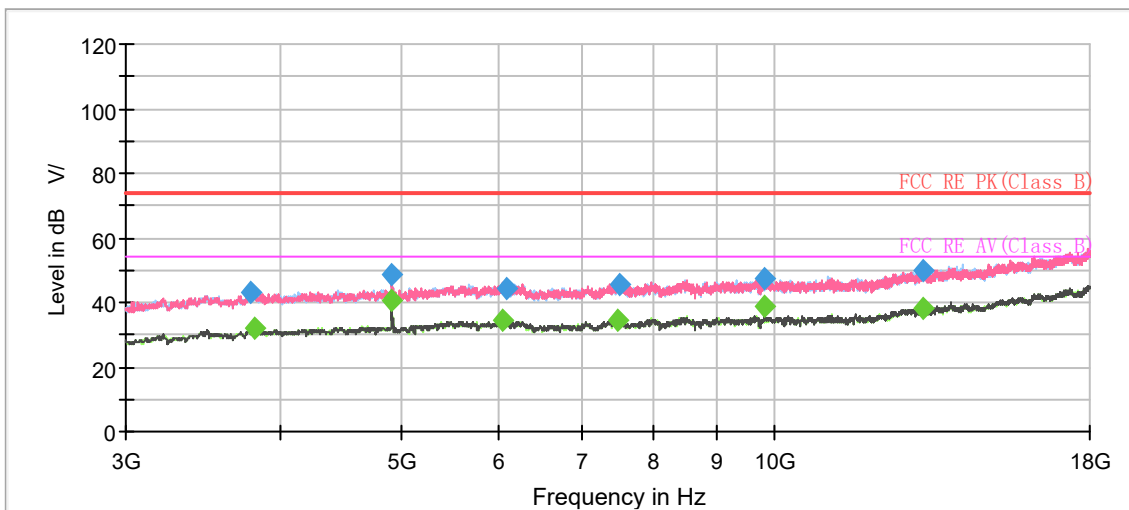

Radiates Emission from 3GHz to 18GHz

Frequency (MHz)	MaxPeak (dB μ V/m)	Average (dB μ V/m)	Limit (dB μ V/m)	Margin (dB)	Meas. Time (ms)	Height (cm)	Pol	Azimuth (deg)	Corr. (dB/m)
1148.000000	44.70	---	74.00	29.30	500.0	200.0	H	14.0	-7.2
1152.000000	---	33.20	54.00	20.80	500.0	100.0	V	325.0	-7.2
1415.000000	46.09	---	74.00	27.91	500.0	200.0	H	51.0	-5.5
1440.000000	---	34.51	54.00	19.49	500.0	200.0	H	83.0	-5.4
1664.500000	46.94	---	74.00	27.06	500.0	100.0	H	53.0	-4.3
1704.500000	---	35.28	54.00	18.72	500.0	100.0	V	154.0	-3.8
2038.500000	48.92	---	74.00	25.08	500.0	200.0	V	284.0	-2.4
2057.500000	---	36.63	54.00	17.37	500.0	200.0	H	14.0	-2.3
2313.500000	---	38.26	54.00	15.74	500.0	100.0	H	300.0	-1.0
2313.500000	49.26	---	74.00	24.74	500.0	200.0	H	60.0	-1.0
2677.750000	---	40.04	54.00	13.96	500.0	200.0	H	227.0	0.9
2680.500000	52.18	---	74.00	21.82	500.0	200.0	H	213.0	0.9
4923.750000	---	40.76	54.00	13.24	500.0	100.0	H	271.0	-2.3

Remark: 1. Correction Factor = Antenna factor + Insertion loss (cable loss + amplifier gain)

2. Margin = Limit -MAX Peak/ Average

802.11g CH1

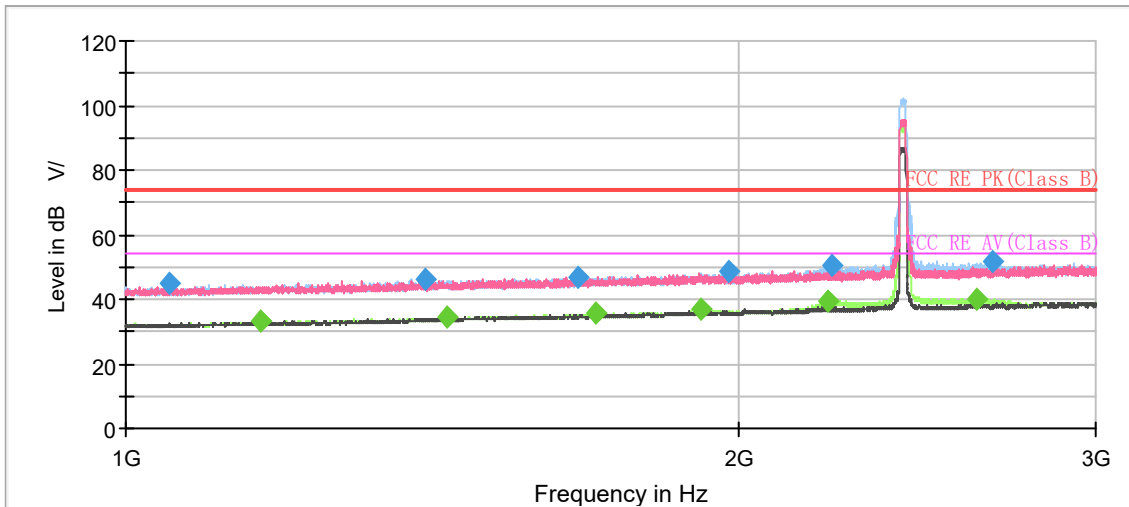

Note: The signal beyond the limit is carrier.
Radiates Emission from 1GHz to 3GHz

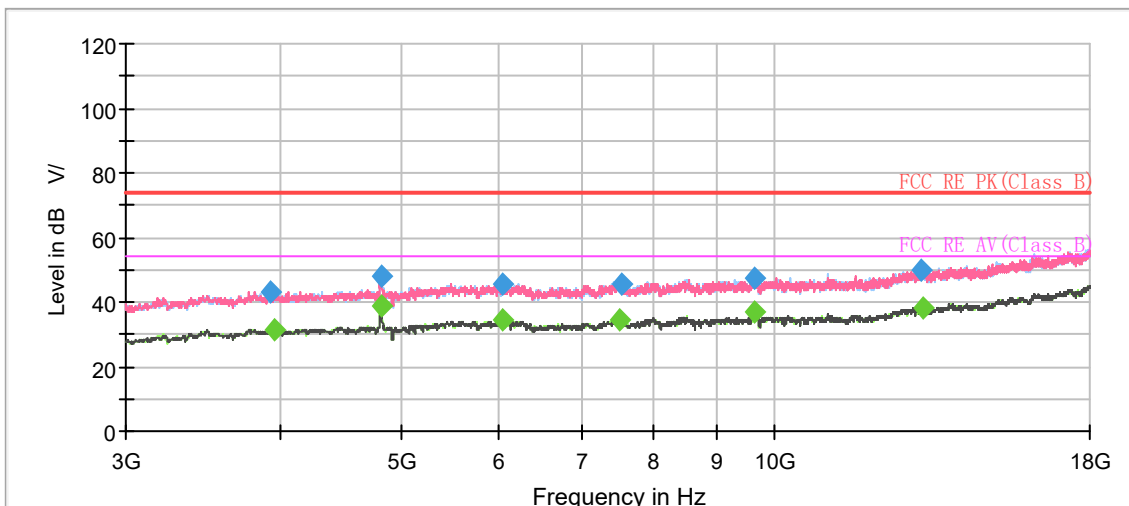

Radiates Emission from 3GHz to 18GHz

Frequency (MHz)	MaxPeak (dB μ V/m)	Average (dB μ V/m)	Limit (dB μ V/m)	Margin (dB)	Meas. Time (ms)	Height (cm)	Pol	Azimuth (deg)	Corr. (dB/m)
1051.500000	44.65	---	74.00	29.35	500.0	100.0	H	288.0	-8.2
1164.000000	---	33.05	54.00	20.95	500.0	200.0	V	300.0	-7.2
1402.500000	45.99	---	74.00	28.01	500.0	200.0	V	0.0	-5.6
1440.250000	---	34.25	54.00	19.75	500.0	100.0	H	279.0	-5.4
1669.250000	47.03	---	74.00	26.97	500.0	200.0	H	22.0	-4.2
1703.750000	---	35.48	54.00	18.52	500.0	200.0	H	302.0	-3.8
1920.000000	---	36.74	54.00	17.26	500.0	200.0	H	100.0	-2.7
1979.000000	48.64	---	74.00	25.36	500.0	100.0	H	107.0	-2.7
2216.500000	---	39.27	54.00	14.73	500.0	100.0	H	233.0	-1.4
2224.000000	50.25	---	74.00	23.75	500.0	200.0	H	235.0	-1.4
2622.000000	---	39.90	54.00	14.10	500.0	100.0	H	283.0	0.3
2667.500000	51.67	---	74.00	22.33	500.0	100.0	H	242.0	0.8

Remark: 1. Correction Factor = Antenna factor + Insertion loss (cable loss + amplifier gain)

2. Margin = Limit –MAX Peak/ Average

802.11g CH6

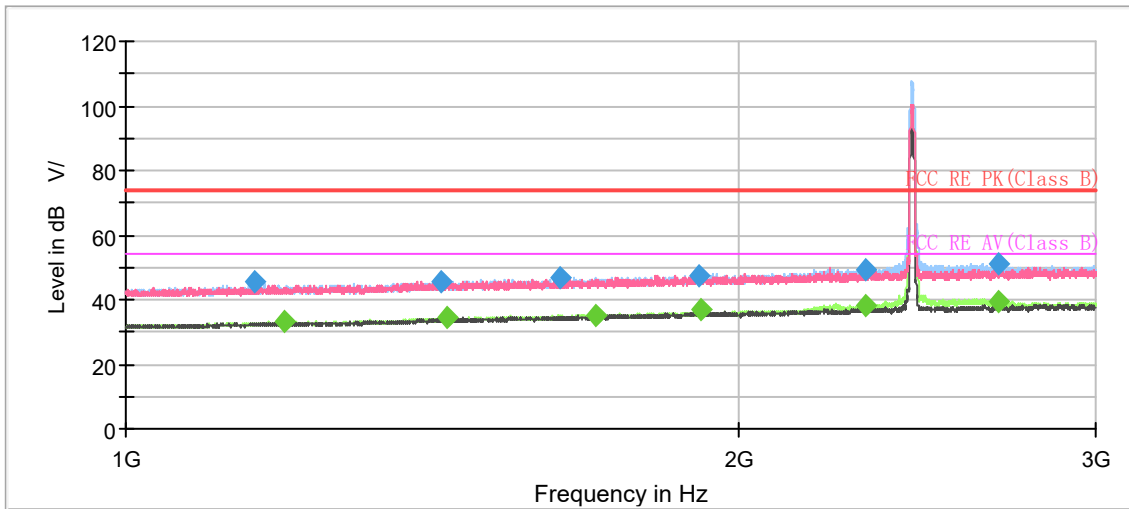

Note: The signal beyond the limit is carrier.
Radiates Emission from 1GHz to 3GHz

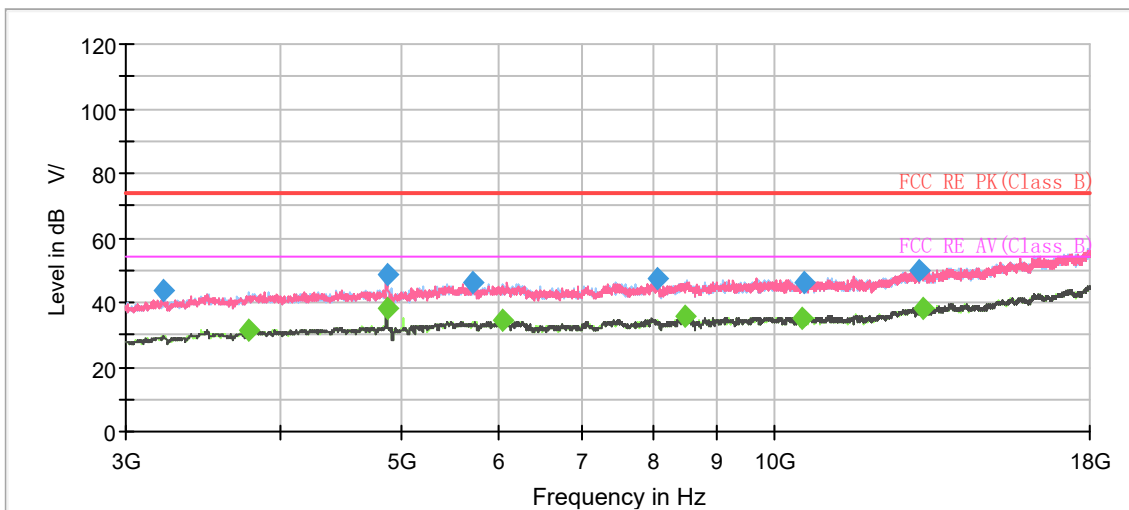

Radiates Emission from 3GHz to 18GHz

Frequency (MHz)	MaxPeak (dB μ V/m)	Average (dB μ V/m)	Limit (dB μ V/m)	Margin (dB)	Meas. Time (ms)	Height (cm)	Pol	Azimuth (deg)	Corr. (dB/m)
1158.000000	45.41	---	74.00	28.59	500.0	200.0	H	0.0	-7.2
1198.000000	---	33.12	54.00	20.88	500.0	100.0	H	340.0	-7.0
1430.250000	45.68	---	74.00	28.32	500.0	100.0	V	259.0	-5.4
1440.000000	---	34.47	54.00	19.53	500.0	200.0	H	82.0	-5.4
1635.750000	46.71	---	74.00	27.29	500.0	200.0	V	212.0	-4.4
1704.250000	---	35.33	54.00	18.67	500.0	200.0	H	3.0	-3.8
1914.000000	47.45	---	74.00	26.55	500.0	100.0	V	226.0	-2.8
1920.000000	---	37.20	54.00	16.80	500.0	200.0	H	104.0	-2.7
2313.250000	49.28	---	74.00	24.72	500.0	100.0	H	223.0	-1.0
2313.500000	---	38.05	54.00	15.95	500.0	200.0	H	194.0	-1.0
2687.000000	51.35	---	74.00	22.65	500.0	100.0	H	228.0	0.8
2688.250000	---	39.56	54.00	14.44	500.0	100.0	H	241.0	0.8

Remark: 1. Correction Factor = Antenna factor + Insertion loss (cable loss + amplifier gain)

2. Margin = Limit –MAX Peak/ Average

802.11g CH11

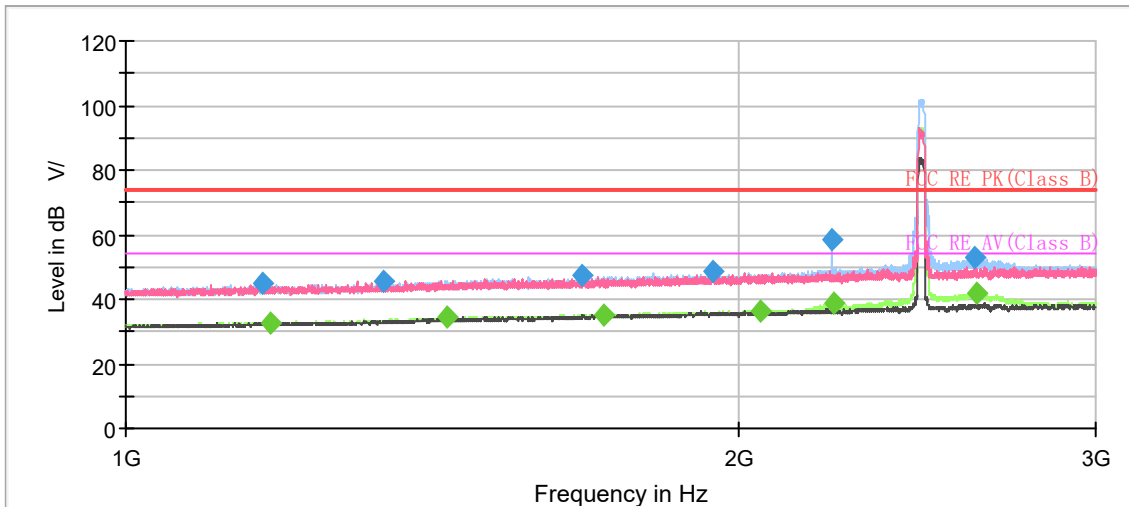

Note: The signal beyond the limit is carrier.
Radiates Emission from 1GHz to 3GHz

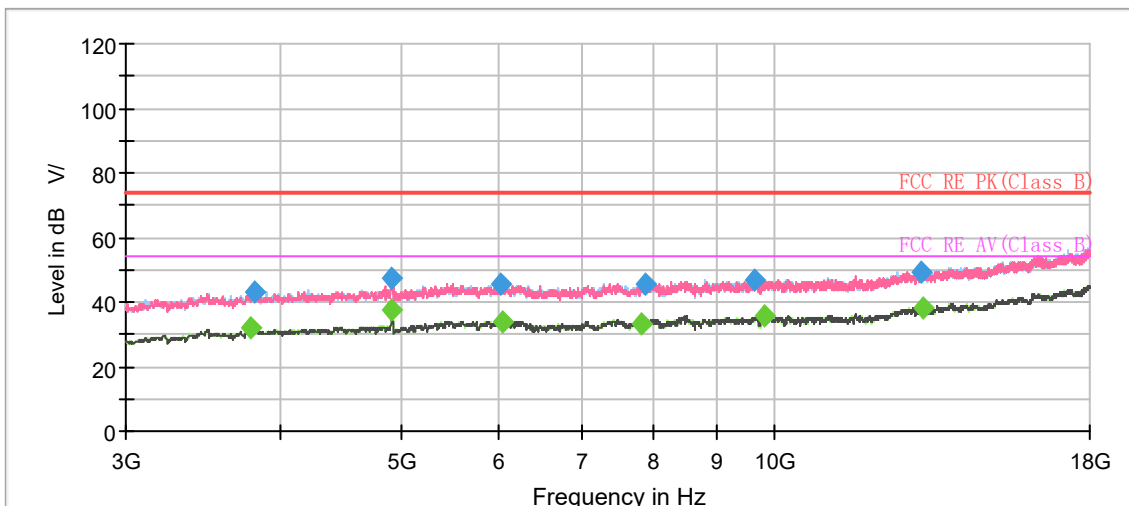

Radiates Emission from 3GHz to 18GHz

Frequency (MHz)	MaxPeak (dB μ V/m)	Average (dB μ V/m)	Limit (dB μ V/m)	Margin (dB)	Meas. Time (ms)	Height (cm)	Pol	Azimuth (deg)	Corr. (dB/m)
1167.500000	44.70	---	74.00	29.30	500.0	100.0	H	128.0	-7.2
1179.250000	---	32.88	54.00	21.12	500.0	100.0	V	10.0	-7.1
1339.750000	45.48	---	74.00	28.52	500.0	200.0	H	126.0	-6.2
1440.000000	---	34.50	54.00	19.50	500.0	200.0	H	82.0	-5.4
1674.750000	47.31	---	74.00	26.69	500.0	200.0	H	260.0	-4.1
1720.000000	---	35.32	54.00	18.68	500.0	200.0	H	121.0	-3.8
1944.750000	48.70	---	74.00	25.30	500.0	100.0	H	194.0	-2.8
2051.000000	---	36.50	54.00	17.50	500.0	200.0	H	170.0	-2.4
2225.250000	58.35	---	74.00	15.65	500.0	100.0	H	184.0	-1.4
2228.500000	---	38.52	54.00	15.48	500.0	200.0	H	180.0	-1.4
2617.750000	52.84	---	74.00	21.16	500.0	100.0	H	227.0	0.2
2622.250000	---	42.03	54.00	11.97	500.0	100.0	H	184.0	0.3

Remark: 1. Correction Factor = Antenna factor + Insertion loss (cable loss + amplifier gain)

2. Margin = Limit –MAX Peak/ Average

802.11n (HT20) CH1

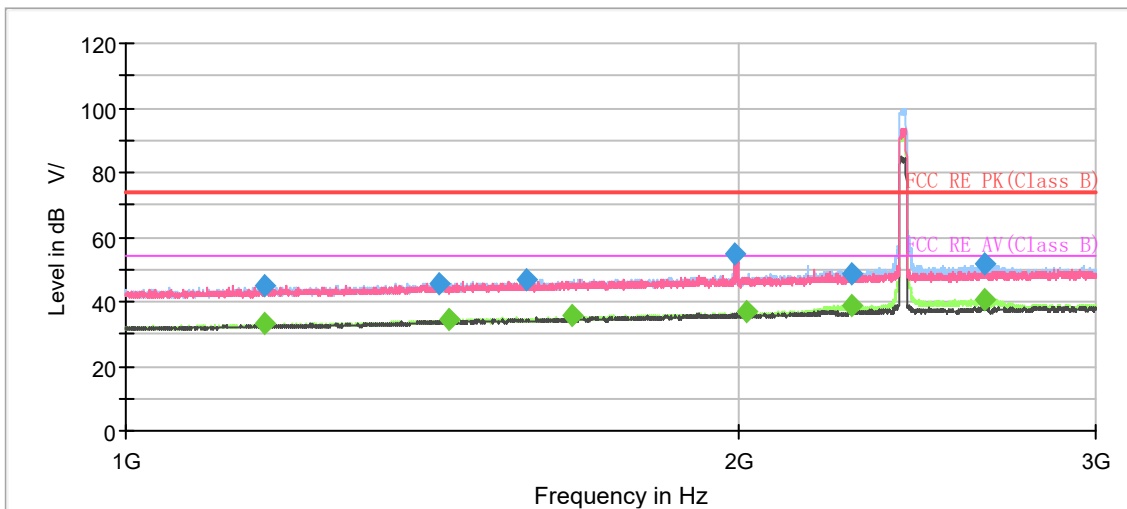

Note: The signal beyond the limit is carrier.
Radiates Emission from 1GHz to 3GHz

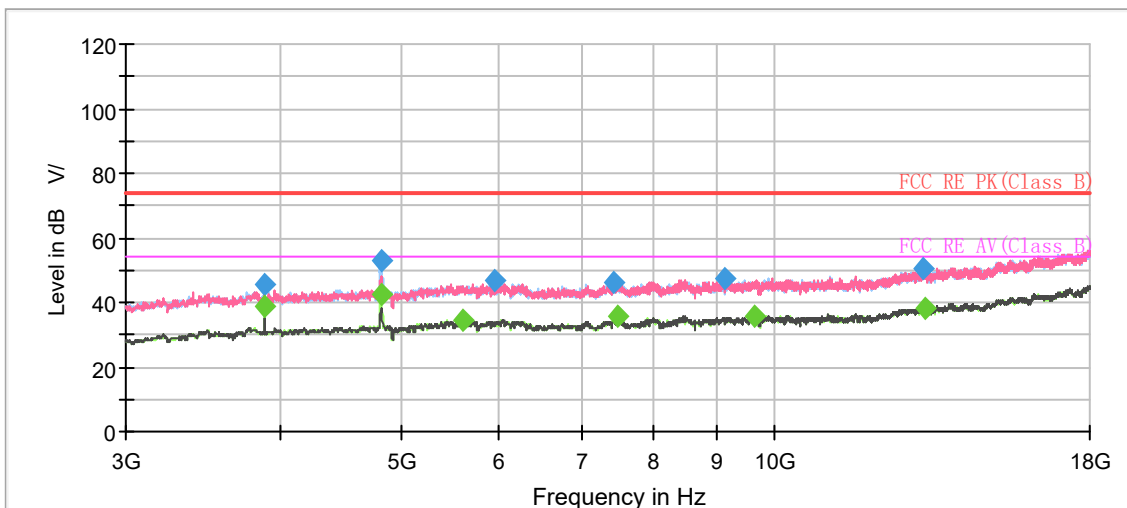

Radiates Emission from 3GHz to 18GHz

Frequency (MHz)	MaxPeak (dB μ V/m)	Average (dB μ V/m)	Limit (dB μ V/m)	Margin (dB)	Meas. Time (ms)	Height (cm)	Pol	Azimuth (deg)	Corr. (dB/m)
1169.750000	---	32.98	54.00	21.02	500.0	200.0	H	18.0	-7.2
1170.500000	45.21	---	74.00	28.79	500.0	200.0	H	112.0	-7.2
1427.000000	45.66	---	74.00	28.34	500.0	200.0	H	89.0	-5.5
1441.500000	---	34.19	54.00	19.81	500.0	100.0	H	311.0	-5.4
1573.250000	46.79	---	74.00	27.21	500.0	200.0	H	22.0	-4.8
1659.000000	---	35.48	54.00	18.52	500.0	200.0	H	31.0	-4.4
1994.000000	54.89	---	74.00	19.11	500.0	200.0	V	101.0	-2.6
2021.250000	---	36.86	54.00	17.14	500.0	200.0	H	209.0	-2.3
2274.250000	48.86	---	74.00	25.14	500.0	100.0	V	34.0	-1.4
2275.750000	---	38.51	54.00	15.49	500.0	200.0	H	272.0	-1.4
2645.000000	51.48	---	74.00	22.52	500.0	200.0	H	267.0	0.5
2646.500000	---	40.44	54.00	13.56	500.0	200.0	H	240.0	0.5
4822.500000	---	42.56	54.00	11.44	500.0	100.0	H	36.0	-2.3

Remark: 1. Correction Factor = Antenna factor + Insertion loss (cable loss + amplifier gain)

2. Margin = Limit -MAX Peak/ Average

802.11n (HT20) CH6

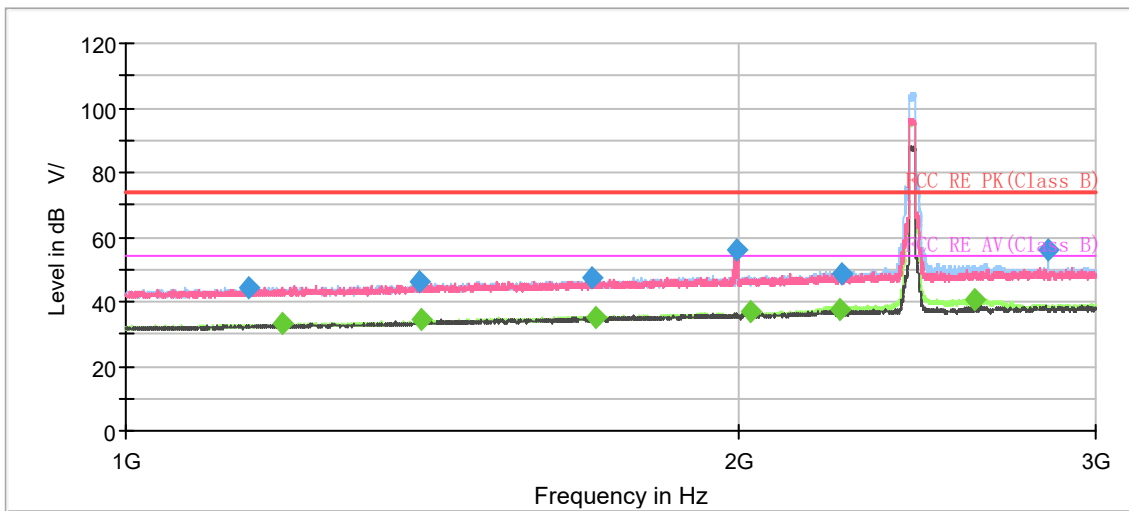

Note: The signal beyond the limit is carrier.
Radiates Emission from 1GHz to 3GHz

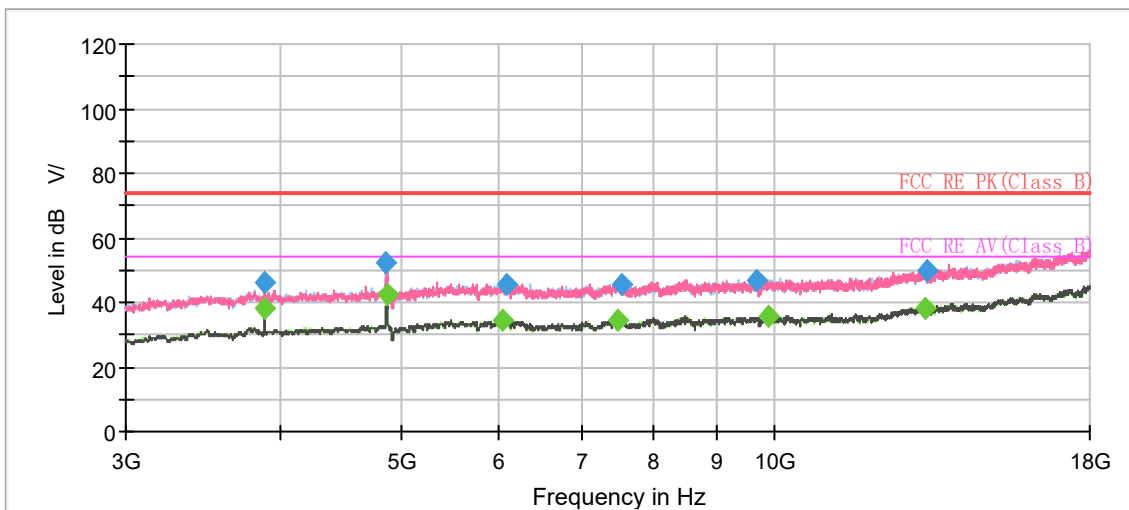

Radiates Emission from 3GHz to 18GHz

Frequency (MHz)	MaxPeak (dB μ V/m)	Average (dB μ V/m)	Limit (dB μ V/m)	Margin (dB)	Meas. Time (ms)	Height (cm)	Pol	Azimuth (deg)	Corr. (dB/m)
1149.500000	44.60	---	74.00	29.40	500.0	200.0	H	168.0	-7.2
1193.750000	---	32.96	54.00	21.04	500.0	200.0	V	130.0	-7.1
1394.000000	46.01	---	74.00	27.99	500.0	200.0	V	0.0	-5.7
1396.750000	---	34.19	54.00	19.81	500.0	200.0	H	84.0	-5.6
1696.500000	47.21	---	74.00	26.79	500.0	200.0	H	2.0	-3.8
1704.750000	---	35.38	54.00	18.62	500.0	100.0	H	335.0	-3.8
1998.500000	56.13	---	74.00	17.87	500.0	200.0	V	44.0	-2.6
2028.500000	---	36.63	54.00	17.37	500.0	200.0	H	235.0	-2.3
2246.500000	---	37.63	54.00	16.37	500.0	200.0	H	267.0	-1.4
2249.000000	48.89	---	74.00	25.11	500.0	200.0	H	276.0	-1.4
2613.500000	---	40.91	54.00	13.09	500.0	200.0	H	263.0	0.2
2841.000000	55.75	---	74.00	18.25	500.0	100.0	H	321.0	1.2
4873.125000	---	42.57	54.00	11.43	500.0	100.0	H	39.0	-2.0

Remark: 1. Correction Factor = Antenna factor + Insertion loss (cable loss + amplifier gain)

2. Margin = Limit -MAX Peak/ Average

802.11n (HT20) CH11

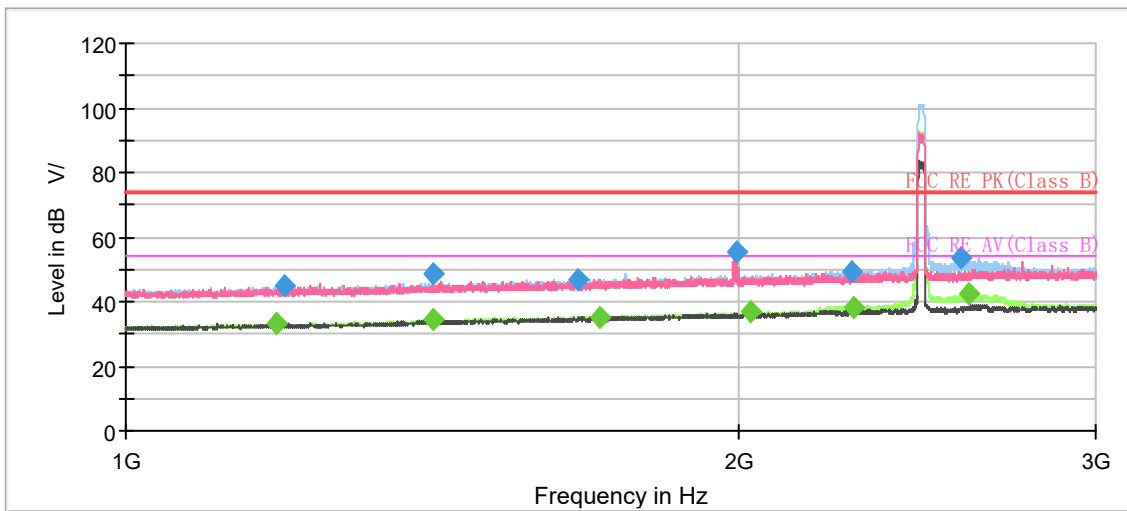

Note: The signal beyond the limit is carrier.
Radiates Emission from 1GHz to 3GHz

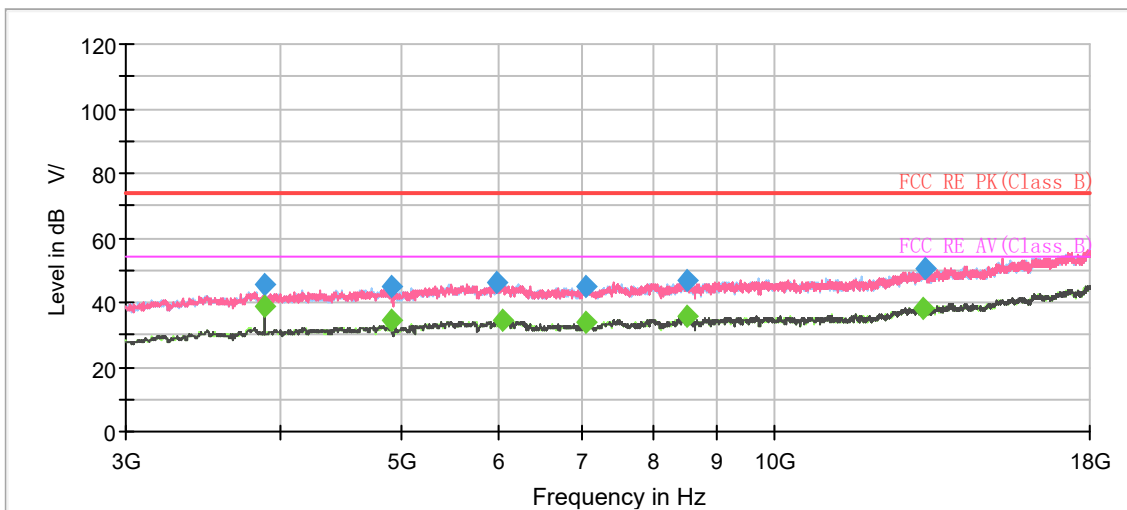

Radiates Emission from 3GHz to 18GHz

Frequency (MHz)	MaxPeak (dB μ V/m)	Average (dB μ V/m)	Limit (dB μ V/m)	Margin (dB)	Meas. Time (ms)	Height (cm)	Pol	Azimuth (deg)	Corr. (dB/m)
1185.250000	---	33.18	54.00	20.82	500.0	200.0	H	81.0	-7.1
1196.500000	45.01	---	74.00	28.99	500.0	100.0	V	217.0	-7.1
1416.500000	48.31	---	74.00	25.69	500.0	200.0	V	296.0	-5.5
1417.750000	---	34.32	54.00	19.68	500.0	100.0	H	348.0	-5.5
1669.500000	47.02	---	74.00	26.98	500.0	200.0	H	136.0	-4.2
1709.000000	---	35.32	54.00	18.68	500.0	200.0	H	61.0	-3.8
1998.750000	55.25	---	74.00	18.75	500.0	100.0	V	50.0	-2.6
2030.000000	---	36.66	54.00	17.34	500.0	200.0	H	69.0	-2.3
2274.500000	49.41	---	74.00	24.59	500.0	200.0	H	272.0	-1.4
2279.500000	---	38.28	54.00	15.72	500.0	100.0	H	269.0	-1.4
2573.500000	53.81	---	74.00	20.19	500.0	200.0	H	257.0	0.0
2599.000000	---	42.32	54.00	11.68	500.0	200.0	H	257.0	0.0

Remark: 1. Correction Factor = Antenna factor + Insertion loss (cable loss + amplifier gain)

2. Margin = Limit - MAX Peak/ Average

802.11n (HT40) CH3

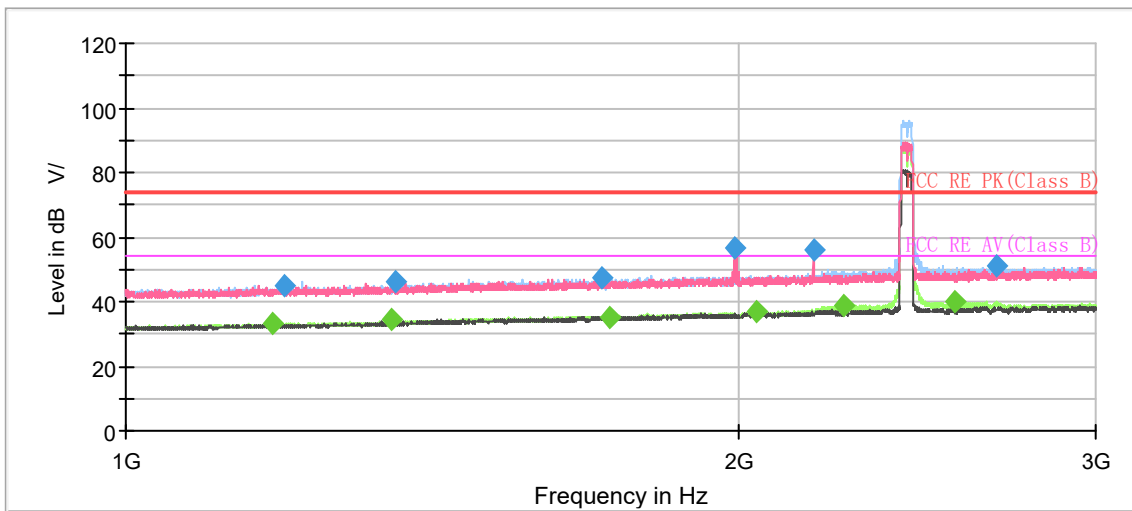

Note: The signal beyond the limit is carrier.
Radiates Emission from 1GHz to 3GHz

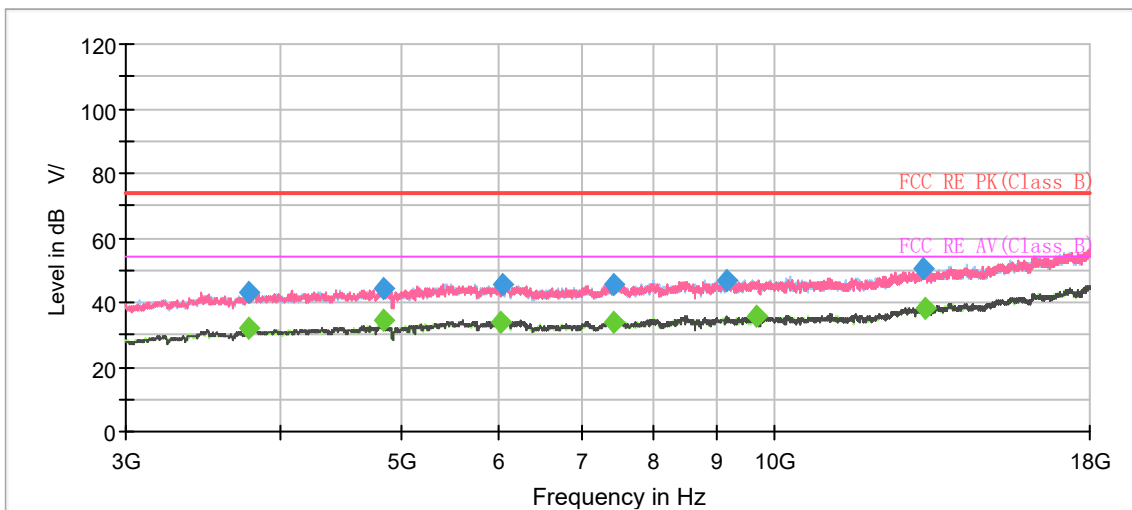

Radiates Emission from 3GHz to 18GHz

Frequency (MHz)	MaxPeak (dB μ V/m)	Average (dB μ V/m)	Limit (dB μ V/m)	Margin (dB)	Meas. Time (ms)	Height (cm)	Pol	Azimuth (deg)	Corr. (dB/m)
1181.750000	---	33.43	54.00	20.57	500.0	200.0	H	97.0	-7.1
1196.250000	44.78	---	74.00	29.22	500.0	200.0	V	265.0	-7.1
1350.000000	---	34.43	54.00	19.57	500.0	200.0	H	153.0	-6.1
1356.250000	46.39	---	74.00	27.61	500.0	100.0	H	125.0	-6.7
1715.500000	47.27	---	74.00	26.73	500.0	200.0	V	332.0	-3.8
1731.000000	---	35.36	54.00	18.64	500.0	100.0	H	97.0	-3.8
1995.000000	56.80	---	74.00	17.20	500.0	200.0	V	94.0	-2.6
2041.000000	---	36.86	54.00	17.14	500.0	100.0	H	45.0	-2.4
2178.250000	56.24	---	74.00	17.76	500.0	200.0	V	225.0	-1.8
2255.000000	---	38.67	54.00	15.33	500.0	200.0	H	271.0	-1.5
2560.250000	---	40.01	54.00	13.99	500.0	100.0	H	239.0	0.0
2679.250000	50.87	---	74.00	23.13	500.0	200.0	H	256.0	0.9

Remark: 1. Correction Factor = Antenna factor + Insertion loss (cable loss + amplifier gain)

2. Margin = Limit –MAX Peak/ Average

802.11n (HT40) CH6

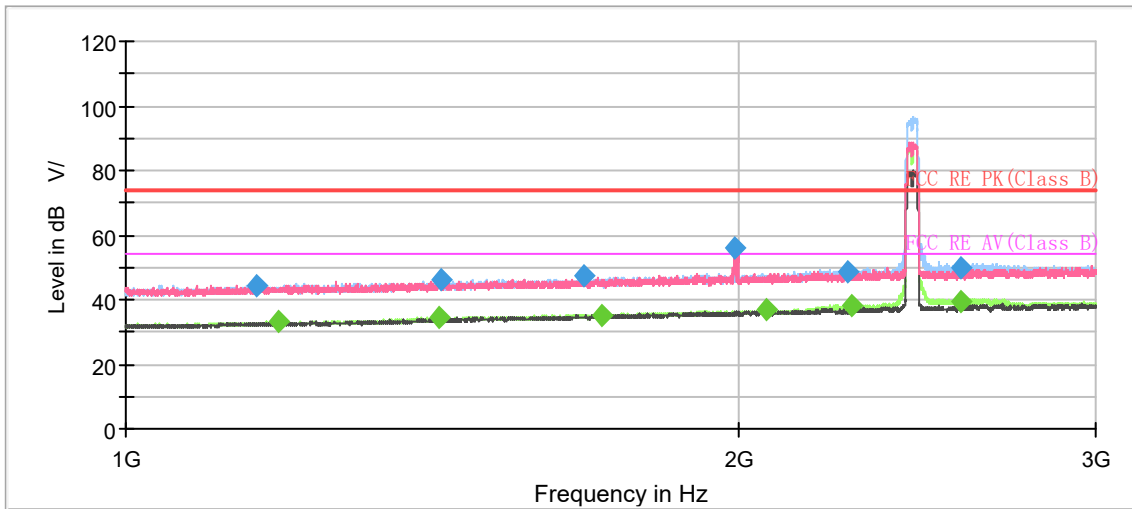

Note: The signal beyond the limit is carrier.
Radiates Emission from 1GHz to 3GHz

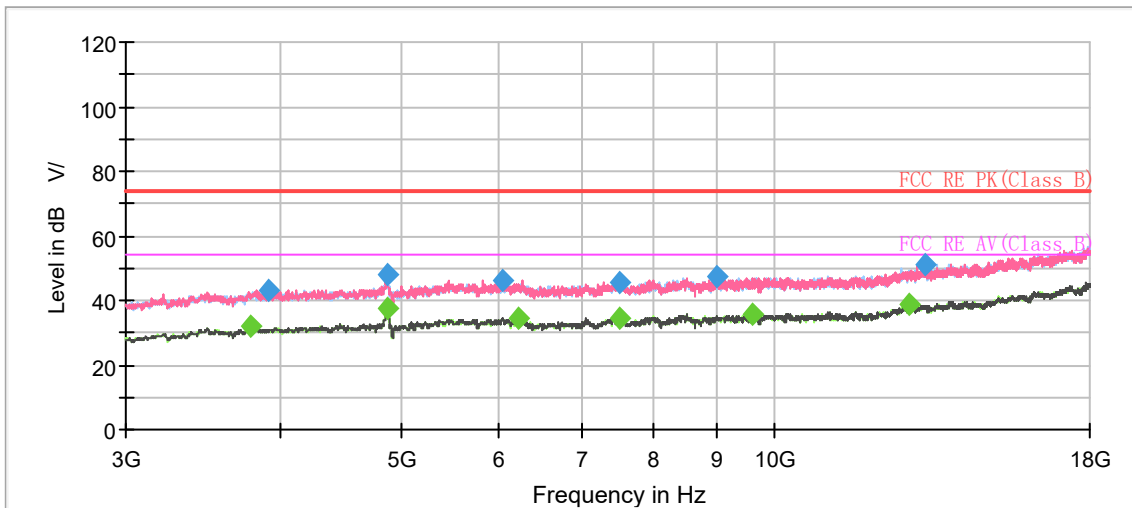

Radiates Emission from 3GHz to 18GHz

Frequency (MHz)	MaxPeak (dB μ V/m)	Average (dB μ V/m)	Limit (dB μ V/m)	Margin (dB)	Meas. Time (ms)	Height (cm)	Pol	Azimuth (deg)	Corr. (dB/m)
1160.500000	44.38	---	74.00	29.62	500.0	100.0	V	214.0	-7.2
1190.000000	---	33.35	54.00	20.65	500.0	200.0	H	265.0	-7.1
1426.750000	---	34.56	54.00	19.44	500.0	100.0	H	0.0	-5.5
1427.750000	46.22	---	74.00	27.78	500.0	100.0	H	3.0	-5.4
1678.500000	47.41	---	74.00	26.59	500.0	200.0	H	106.0	-4.1
1715.750000	---	35.38	54.00	18.62	500.0	200.0	H	351.0	-3.8
1994.000000	56.01	---	74.00	17.99	500.0	100.0	V	109.0	-2.6
2066.250000	---	36.63	54.00	17.37	500.0	100.0	H	162.0	-2.1
2266.000000	48.86	---	74.00	25.14	500.0	100.0	H	0.0	-1.5
2275.750000	---	38.02	54.00	15.98	500.0	200.0	H	0.0	-1.4
2576.000000	---	39.52	54.00	14.48	500.0	200.0	H	260.0	0.0
2577.250000	49.77	---	74.00	24.23	500.0	200.0	H	260.0	0.0

Remark: 1. Correction Factor = Antenna factor + Insertion loss (cable loss + amplifier gain)

2. Margin = Limit - MAX Peak/ Average

802.11n (HT40) CH9

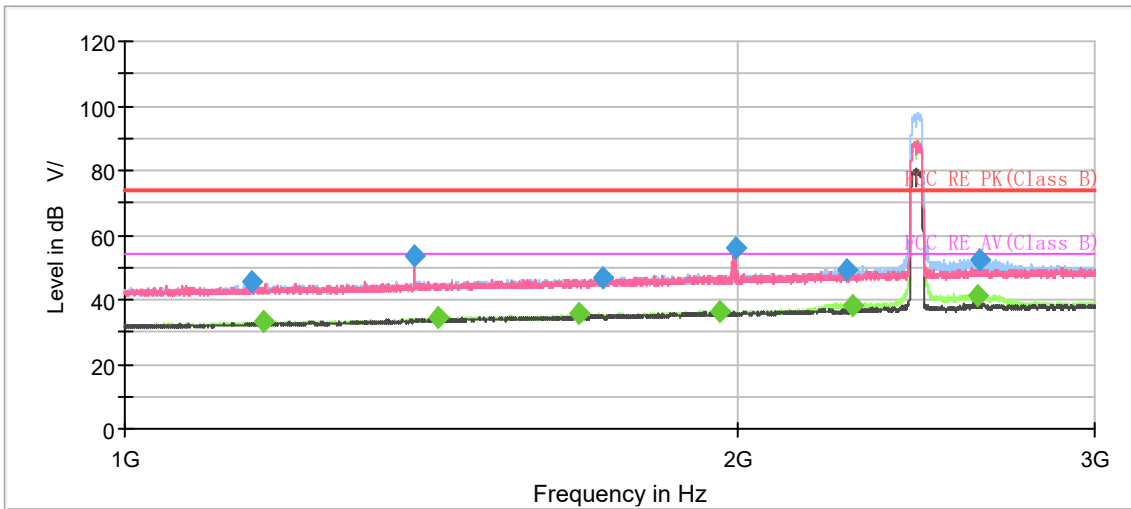

Note: The signal beyond the limit is carrier.
Radiates Emission from 1GHz to 3GHz

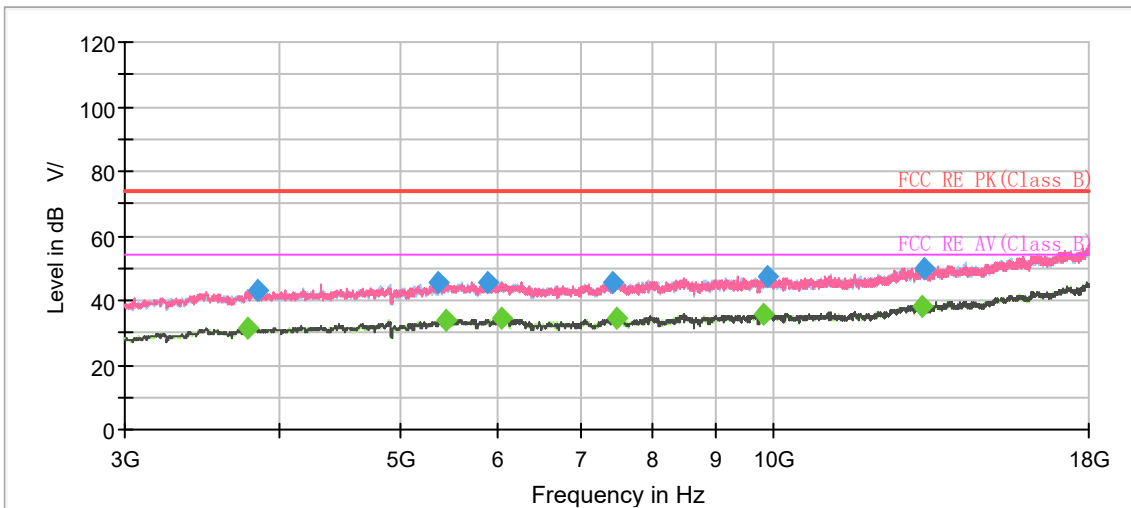

Radiates Emission from 3GHz to 18GHz

Frequency (MHz)	MaxPeak (dB μ V/m)	Average (dB μ V/m)	Limit (dB μ V/m)	Margin (dB)	Meas. Time (ms)	Height (cm)	Pol	Azimuth (deg)	Corr. (dB/m)
1154.500000	45.27	---	74.00	28.73	500.0	100.0	V	345.0	-7.2
1170.250000	---	33.22	54.00	20.78	500.0	100.0	H	66.0	-7.2
1388.750000	53.40	---	74.00	20.60	500.0	200.0	V	318.0	-5.7
1426.500000	---	34.25	54.00	19.75	500.0	200.0	H	290.0	-5.5
1671.750000	---	35.52	54.00	18.48	500.0	100.0	H	114.0	-4.2
1717.000000	46.99	---	74.00	27.01	500.0	100.0	V	286.0	-3.8
1964.250000	---	36.54	54.00	17.46	500.0	100.0	H	30.0	-2.7
1998.250000	55.73	---	74.00	18.27	500.0	200.0	V	63.0	-2.6
2267.750000	49.38	---	74.00	24.62	500.0	200.0	H	268.0	-1.4
2278.750000	---	38.38	54.00	15.62	500.0	200.0	H	282.0	-1.4
2626.750000	---	41.02	54.00	12.98	500.0	100.0	H	258.0	0.3
2633.500000	52.39	---	74.00	21.61	500.0	100.0	H	262.0	0.4

Remark: 1. Correction Factor = Antenna factor + Insertion loss (cable loss + amplifier gain)

2. Margin = Limit –MAX Peak/ Average

During the test, the Radiates Emission from 18GHz to 26.5GHz was performed in all modes with all channels, 802.11b CH6 are selected as the worst condition. The test data of the worst-case condition was recorded in this report.

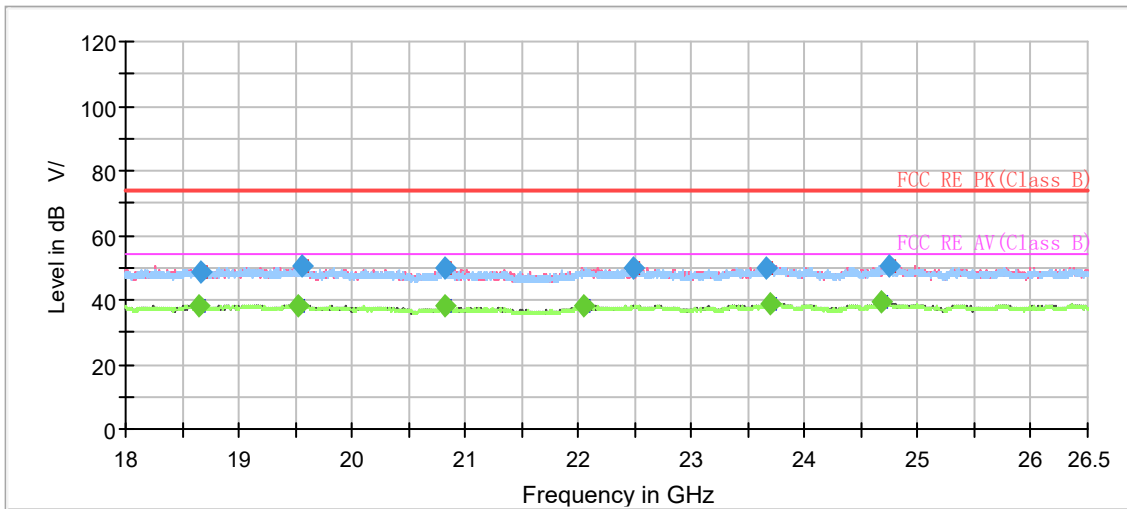

Radiates Emission from 18GHz to 26.5GHz

Frequency (MHz)	MaxPeak (dBμV/m)	Average (dBμV/m)	Limit (dBμV/m)	Margin (dB)	Meas. Time (ms)	Height (cm)	Pol	Azimuth (deg)	Corr. (dB/m)
18643.875000	---	37.98	54.00	16.02	500.0	100.0	V	139.0	-5.6
18658.750000	48.84	---	74.00	25.16	500.0	100.0	V	335.0	-5.6
19525.750000	---	38.45	54.00	15.55	500.0	200.0	V	225.0	-5.3
19564.000000	50.20	---	74.00	23.80	500.0	100.0	V	208.0	-5.3
20814.562500	---	38.04	54.00	15.96	500.0	200.0	V	131.0	-5.1
20824.125000	49.64	---	74.00	24.36	500.0	200.0	H	25.0	-5.1
22047.062500	---	38.36	54.00	15.64	500.0	200.0	V	30.0	-4.2
22485.875000	49.92	---	74.00	24.08	500.0	100.0	V	124.0	-3.9
23663.125000	50.12	---	74.00	23.88	500.0	100.0	H	21.0	-2.6
23702.437500	---	38.50	54.00	15.50	500.0	100.0	V	45.0	-2.5
24684.187500	---	39.13	54.00	14.87	500.0	100.0	H	150.0	-2.1
24751.125000	50.31	---	74.00	23.69	500.0	100.0	V	218.0	-2.1

Remark: 1. Correction Factor = Antenna factor + Insertion loss (cable loss + amplifier gain)
 2. Margin = Limit –MAX Peak/ Average

Bluetooth LE

During the test, the Radiates Emission from 30MHz to 1GHz was performed in all modes with all channels, Bluetooth LE-Channel 0 are selected as the worst condition. The test data of the worst-case condition was recorded in this report.

A symbol ($\text{dB } \mu\text{V/m}$) in the test plot below means ($\text{dB}\mu\text{V/m}$)

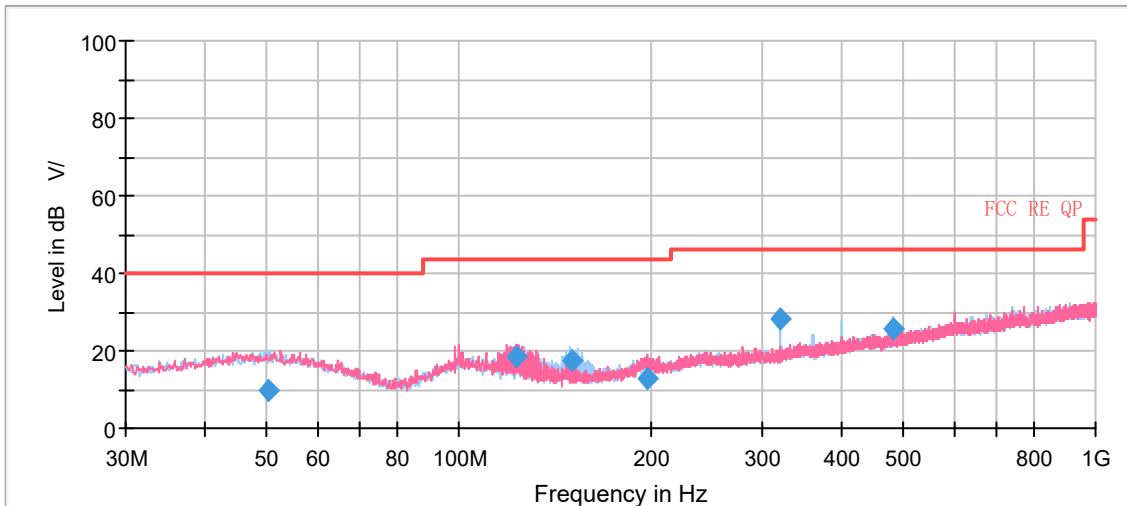

Radiates Emission from 30MHz to 1GHz

Frequency (MHz)	Quasi-Peak ($\text{dB}\mu\text{V/m}$)	Limit ($\text{dB}\mu\text{V/m}$)	Margin (dB)	Height (cm)	Polarization	Azimuth (deg)	Correct Factor (dB)
50.290000	9.91	40.00	30.09	125.0	H	116.0	20.6
123.200000	18.34	43.50	25.16	100.0	V	75.0	16.0
150.157500	17.43	43.50	26.07	225.0	H	85.0	14.6
197.648750	12.69	43.50	30.81	100.0	V	55.0	18.3
319.990000	28.03	46.00	17.97	100.0	H	0.0	20.8
479.998750	25.51	46.00	20.49	184.0	H	104.0	24.2

- Remark: 1. Correction Factor = Antenna factor + Insertion loss (cable loss + amplifier gain)**
2. Margin = Limit – Quasi-Peak

Bluetooth LE-Channel 0

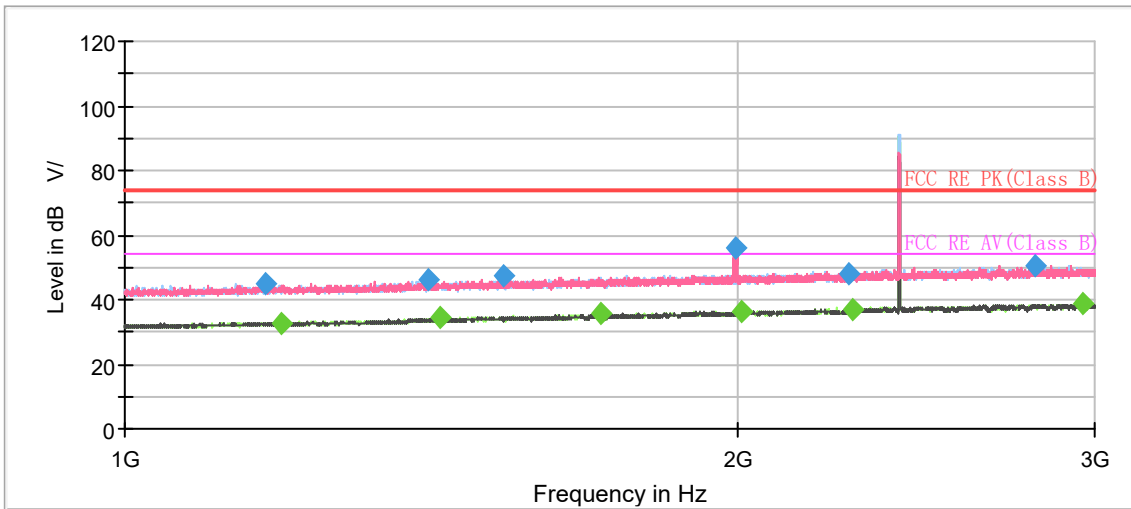

Note: The signal beyond the limit is carrier.
Radiates Emission from 1GHz to 3GHz

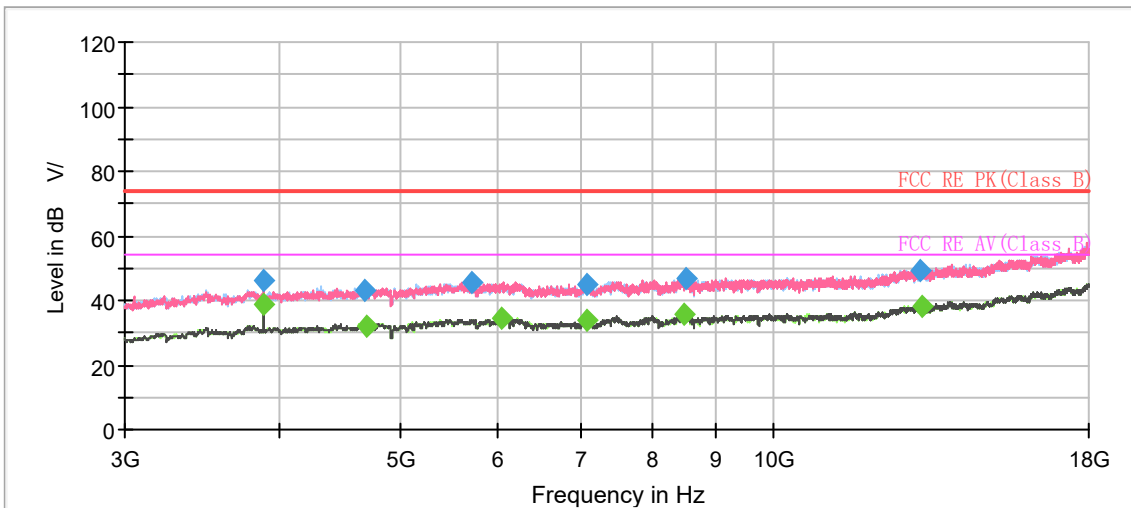

Radiates Emission from 3GHz to 18GHz

Frequency (MHz)	MaxPeak (dB μ V/m)	Average (dB μ V/m)	Limit (dB μ V/m)	Margin (dB)	Meas. Time (ms)	Height (cm)	Pol	Azimuth (deg)	Corr. (dB/m)
1173.250000	44.83	---	74.00	29.17	500.0	100.0	H	41.0	-7.1
1194.500000	---	32.88	54.00	21.12	500.0	100.0	H	72.0	-7.1
1411.750000	45.96	---	74.00	28.04	500.0	100.0	V	324.0	-5.5
1428.500000	---	34.26	54.00	19.74	500.0	100.0	V	314.0	-5.4
1536.500000	47.10	---	74.00	26.90	500.0	100.0	H	188.0	-4.6
1716.500000	---	35.42	54.00	18.58	500.0	100.0	H	242.0	-3.8
1998.000000	55.76	---	74.00	18.24	500.0	100.0	V	49.0	-2.6
2010.500000	---	36.41	54.00	17.59	500.0	100.0	V	49.0	-2.4
2271.750000	47.89	---	74.00	26.11	500.0	200.0	H	131.0	-1.4
2278.750000	---	37.22	54.00	16.78	500.0	200.0	V	18.0	-1.4
2803.000000	50.65	---	74.00	23.35	500.0	100.0	H	46.0	1.1
2958.250000	---	38.51	54.00	15.49	500.0	100.0	H	55.0	1.5
3886.875000	---	38.85	54.00	15.15	500.0	100.0	H	311.0	-4.9

Remark: 1. Correction Factor = Antenna factor + Insertion loss (cable loss + amplifier gain)

2. Margin = Limit -MAX Peak/ Average

Bluetooth LE-Channel 19

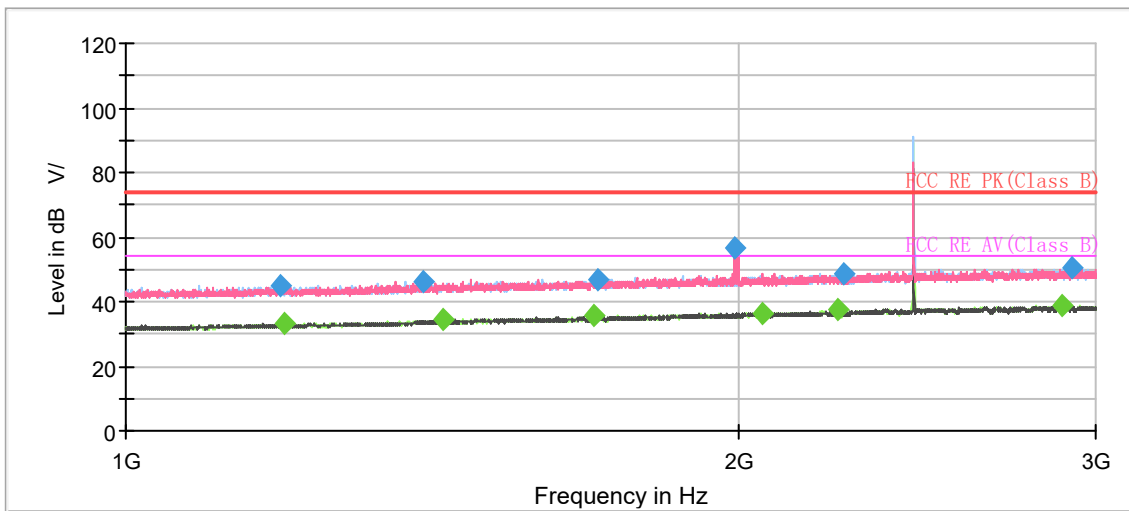

Note: The signal beyond the limit is carrier.
Radiates Emission from 1GHz to 3GHz

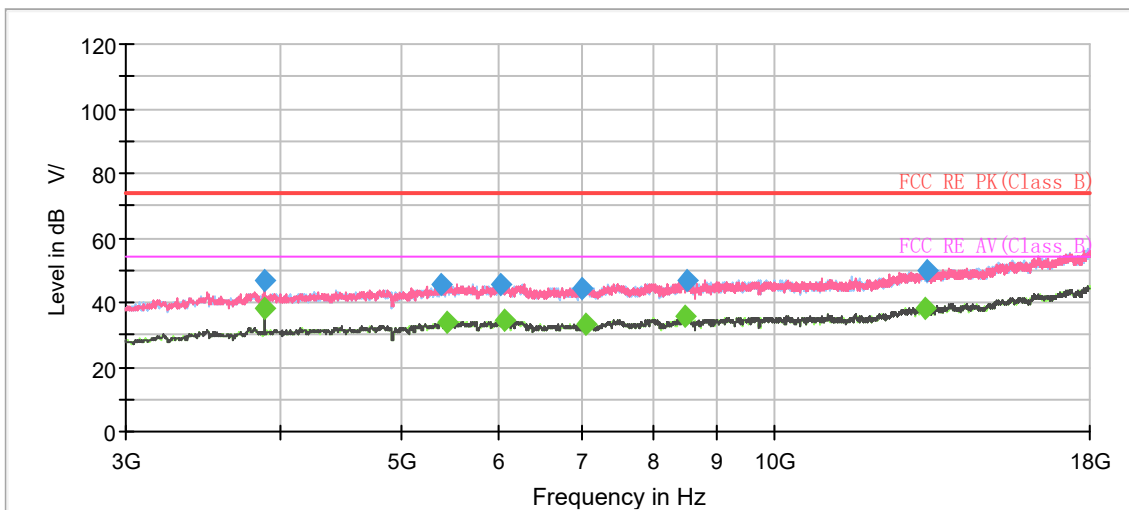

Radiates Emission from 3GHz to 18GHz

Frequency (MHz)	MaxPeak (dB μ V/m)	Average (dB μ V/m)	Limit (dB μ V/m)	Margin (dB)	Meas. Time (ms)	Height (cm)	Pol	Azimuth (deg)	Corr. (dB/m)
1192.750000	44.67	---	74.00	29.33	500.0	100.0	H	69.0	-7.1
1198.000000	---	33.24	54.00	20.76	500.0	200.0	V	180.0	-7.0
1400.250000	46.12	---	74.00	27.88	500.0	200.0	H	355.0	-5.6
1432.500000	---	34.53	54.00	19.47	500.0	100.0	V	0.0	-5.4
1697.500000	---	35.41	54.00	18.59	500.0	200.0	H	216.0	-3.8
1707.250000	47.02	---	74.00	26.98	500.0	100.0	V	209.0	-3.8
1992.500000	56.51	---	74.00	17.49	500.0	200.0	V	51.0	-2.7
2058.250000	---	36.38	54.00	17.62	500.0	200.0	H	265.0	-2.3
2240.250000	---	37.32	54.00	16.68	500.0	200.0	H	265.0	-1.4
2254.750000	48.59	---	74.00	25.41	500.0	100.0	H	47.0	-1.5
2885.750000	---	38.66	54.00	15.34	500.0	200.0	H	56.0	1.2
2920.250000	50.19	---	74.00	23.81	500.0	200.0	H	0.0	1.7

Remark: 1. Correction Factor = Antenna factor + Insertion loss (cable loss + amplifier gain)

2. Margin = Limit –MAX Peak/ Average

Bluetooth LE-Channel 39

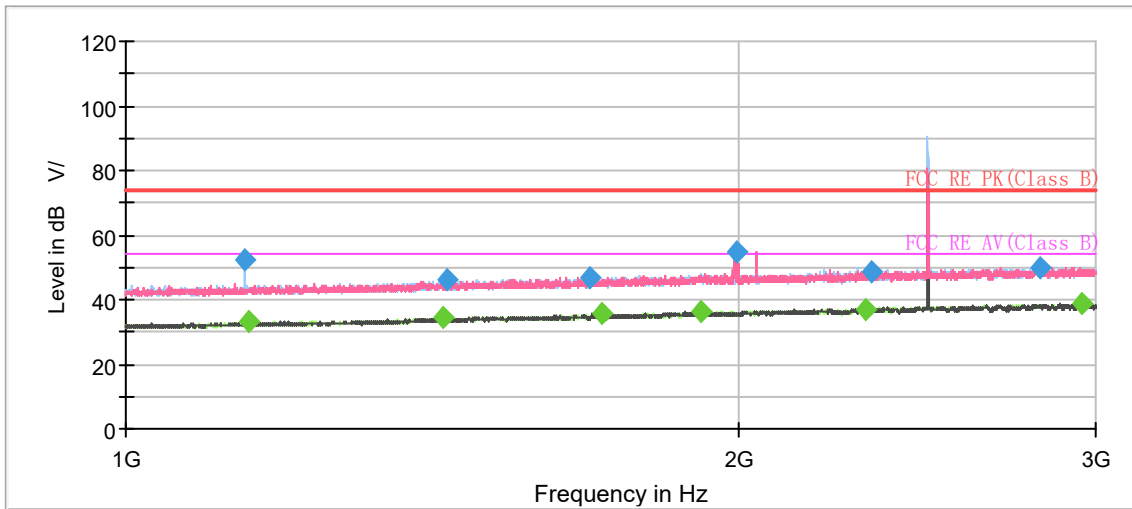

Note: The signal beyond the limit is carrier.
Radiates Emission from 1GHz to 3GHz

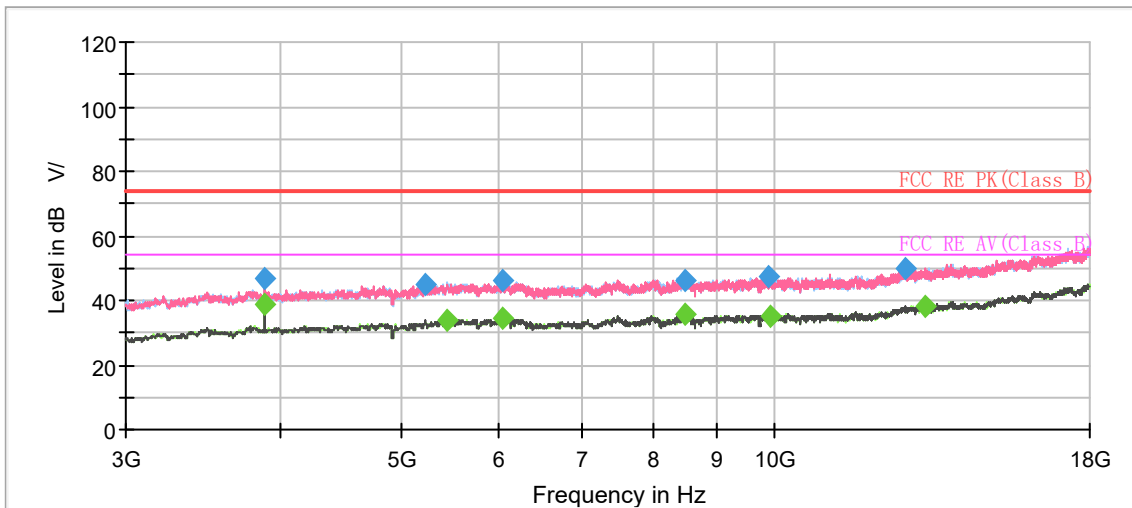

Radiates Emission from 3GHz to 18GHz

Frequency (MHz)	MaxPeak (dB μ V/m)	Average (dB μ V/m)	Limit (dB μ V/m)	Margin (dB)	Meas. Time (ms)	Height (cm)	Pol	Azimuth (deg)	Corr. (dB/m)
1144.750000	52.10	---	74.00	21.90	500.0	100.0	H	23.0	-7.3
1150.000000	---	33.19	54.00	20.81	500.0	100.0	V	199.0	-7.2
1434.000000	---	34.19	54.00	19.81	500.0	200.0	H	112.0	-5.4
1440.000000	45.88	---	74.00	28.12	500.0	100.0	H	149.0	-5.4
1692.500000	46.96	---	74.00	27.04	500.0	100.0	H	100.0	-3.8
1716.500000	---	35.43	54.00	18.57	500.0	200.0	H	337.0	-3.8
1917.000000	---	36.45	54.00	17.55	500.0	200.0	V	275.0	-2.8
1998.750000	54.63	---	74.00	19.37	500.0	200.0	V	109.0	-2.6
2312.250000	---	37.17	54.00	16.83	500.0	100.0	V	186.0	-1.0
2326.000000	48.58	---	74.00	25.42	500.0	100.0	V	137.0	-1.1
2816.750000	49.97	---	74.00	24.03	500.0	100.0	H	216.0	1.3
2952.500000	---	38.67	54.00	15.33	500.0	200.0	H	229.0	1.6

Remark: 1. Correction Factor = Antenna factor + Insertion loss (cable loss + amplifier gain)

2. Margin = Limit –MAX Peak/ Average

During the test, the Radiates Emission from 18GHz to 26.5GHz was performed in all modes with all channels, Bluetooth LE-Channel 0 are selected as the worst condition. The test data of the worst-case condition was recorded in this report.

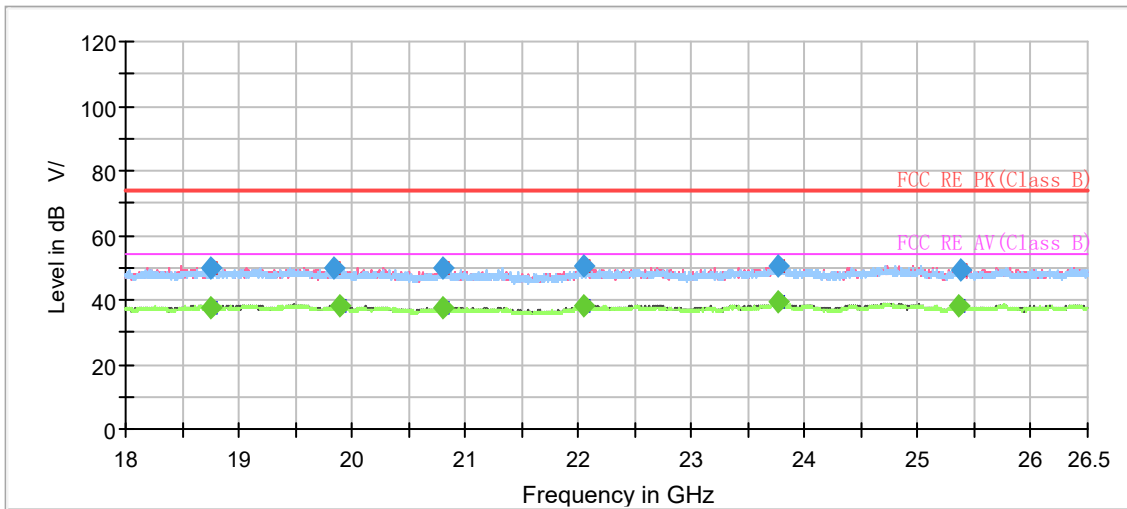

Radiates Emission from 18GHz to 26.5GHz

Frequency (MHz)	MaxPeak (dBμV/m)	Average (dBμV/m)	Limit (dBμV/m)	Margin (dB)	Meas. Time (ms)	Height (cm)	Pol	Azimuth (deg)	Corr. (dB/m)
18751.187500	---	37.65	54.00	16.35	500.0	100.0	V	86.0	-5.5
18752.250000	49.56	---	74.00	24.44	500.0	200.0	V	105.0	-5.5
19838.125000	49.55	---	74.00	24.45	500.0	100.0	V	0.0	-5.2
19895.500000	---	38.00	54.00	16.00	500.0	100.0	V	136.0	-5.2
20798.625000	---	37.80	54.00	16.20	500.0	100.0	V	121.0	-5.1
20809.250000	49.90	---	74.00	24.10	500.0	100.0	H	232.0	-5.1
22040.687500	50.32	---	74.00	23.68	500.0	200.0	V	81.0	-4.2
22046.000000	---	38.16	54.00	15.84	500.0	200.0	V	295.0	-4.2
23759.812500	50.47	---	74.00	23.53	500.0	100.0	H	179.0	-2.4
23766.187500	---	39.08	54.00	14.92	500.0	100.0	V	315.0	-2.4
25367.375000	---	38.05	54.00	15.95	500.0	200.0	V	86.0	-2.6
25385.437500	49.53	---	74.00	24.47	500.0	100.0	V	241.0	-2.6

Remark: 1. Correction Factor = Antenna factor + Insertion loss (cable loss + amplifier gain)
 2. Margin = Limit –MAX Peak/ Average

5.2. Conducted Emission

Ambient Condition

Temperature	Relative humidity
20°C ~ 25°C	45% ~ 50%

Methods of Measurement

The EUT is placed on a non-metallic table of 80cm height above the horizontal metal reference ground plane. During the test, the EUT was operating in its typical mode. The test method is according to ANSI C63.10. Connect the AC power line of the EUT to the L.I.S.N. Use EMI receiver to detect the average and Quasi-peak value. RBW is set to 9 kHz, VBW is set to 30kHz. The measurement result should include both L line and N line. The test is in transmitting mode.

Test Setup

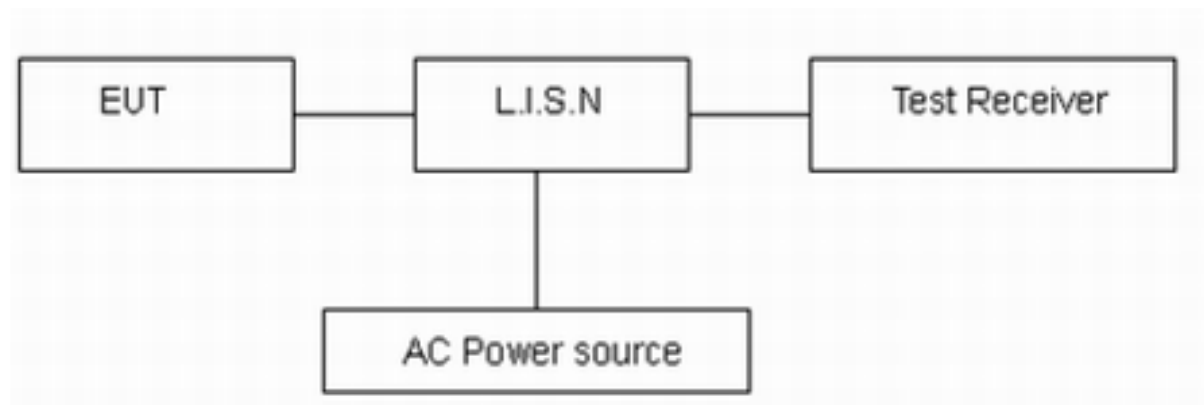

Note: AC Power source is used to change the voltage 120V/60Hz.

Limits

Frequency (MHz)	Conducted Limits(dBμV)	
	Quasi-peak	Average
0.15 - 0.5	66 to 56 *	56 to 46*
0.5 - 5	56	46
5 - 30	60	50

*: Decreases with the logarithm of the frequency.

Measurement Uncertainty

The assessed measurement uncertainty to ensure 95% confidence level for the normal distribution is with the coverage factor $k = 1.96$, $U = 2.69$ dB.

Test Results:

Following plots, Blue trace uses the peak detection and Green trace uses the average detection.

Wi-Fi 2.4G

During the test, the Conducted Emission was performed in all modes with all channels, 802.11b, Channel 6 are selected as the worst condition. The test data of the worst-case condition was recorded in this report.

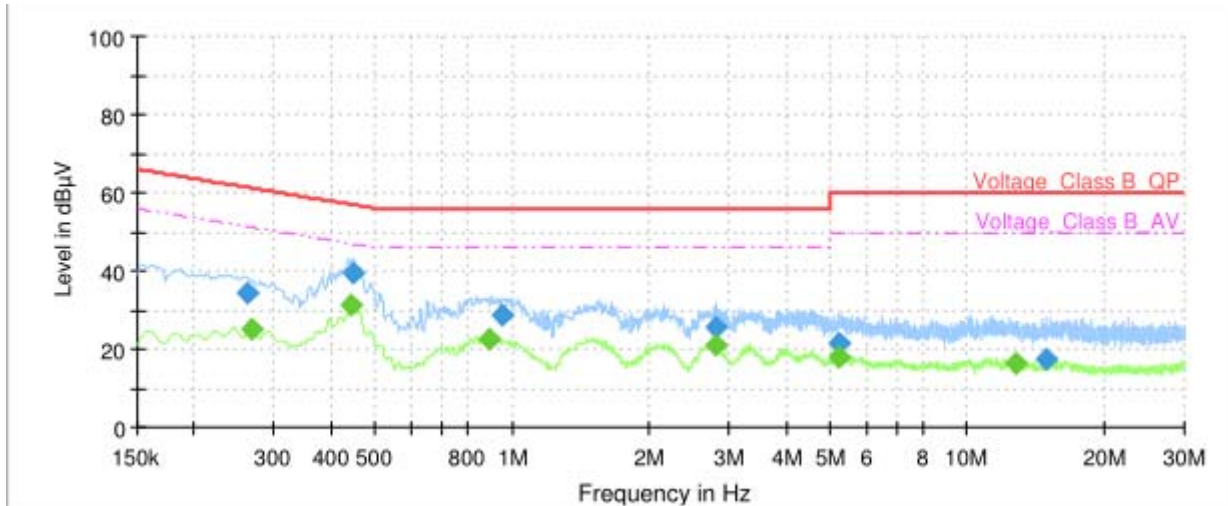

Frequency (MHz)	QuasiPeak (dBµV)	Average (dBµV)	Limit (dBµV)	Margin (dB)	Meas. Time (ms)	Bandwidth (kHz)	Line	Filter	Corr. (dB)
0.26	34.39	---	61.35	26.96	1000.0	9.000	L1	ON	21.1
0.27	---	25.32	51.21	25.89	1000.0	9.000	L1	ON	21.1
0.44	---	31.43	47.02	15.59	1000.0	9.000	L1	ON	20.9
0.45	39.34	---	56.89	17.55	1000.0	9.000	L1	ON	20.9
0.89	---	22.64	46.00	23.36	1000.0	9.000	L1	ON	20.3
0.95	28.70	---	56.00	27.30	1000.0	9.000	L1	ON	20.3
2.79	---	20.90	46.00	25.10	1000.0	9.000	L1	ON	19.6
2.81	25.51	---	56.00	30.49	1000.0	9.000	L1	ON	19.6
5.21	21.37	---	60.00	38.63	1000.0	9.000	L1	ON	19.5
5.23	---	18.09	50.00	31.91	1000.0	9.000	L1	ON	19.5
12.75	---	16.59	50.00	33.41	1000.0	9.000	L1	ON	19.6
14.98	17.64	---	60.00	42.36	1000.0	9.000	L1	ON	19.6

Remark: Correct factor=cable loss + LISN factor

L line Conducted Emission from 150 KHz to 30 MHz

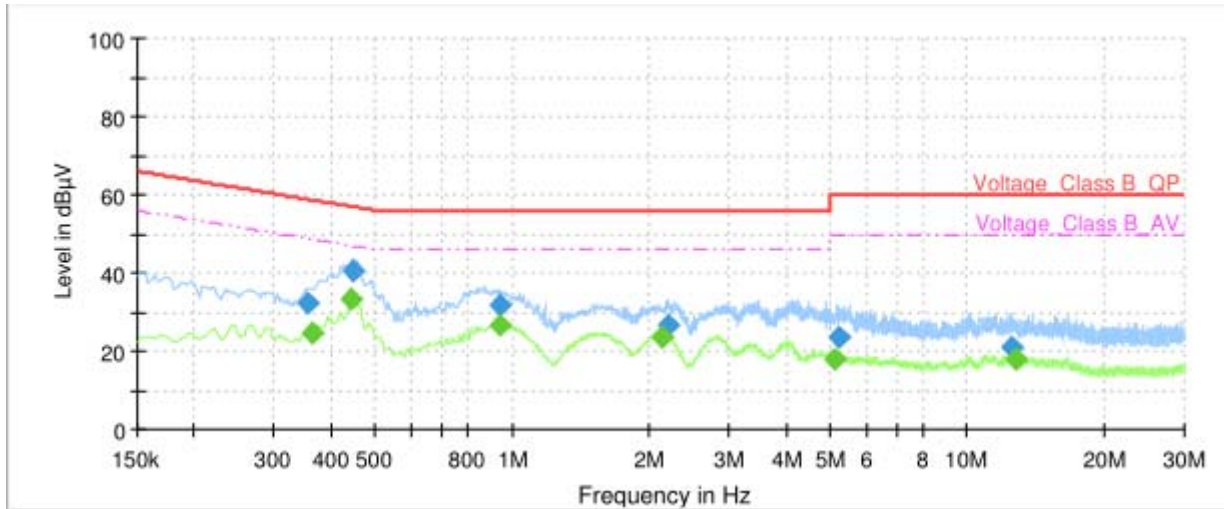

Frequency (MHz)	QuasiPeak (dBµV)	Average (dBµV)	Limit (dBµV)	Margin (dB)	Meas. Time (ms)	Bandwidth (kHz)	Line	Filter	Corr. (dB)
0.36	32.55	---	58.80	26.25	1000.0	9.000	N	ON	21.0
0.36	---	24.48	48.69	24.21	1000.0	9.000	N	ON	21.0
0.44	---	33.21	47.02	13.81	1000.0	9.000	N	ON	20.9
0.45	40.73	---	56.93	16.20	1000.0	9.000	N	ON	20.9
0.94	---	26.57	46.00	19.43	1000.0	9.000	N	ON	20.3
0.94	32.05	---	56.00	23.95	1000.0	9.000	N	ON	20.3
2.14	---	23.55	46.00	22.45	1000.0	9.000	N	ON	19.7
2.20	26.65	---	56.00	29.35	1000.0	9.000	N	ON	19.7
5.13	---	18.13	50.00	31.87	1000.0	9.000	N	ON	19.5
5.20	23.82	---	60.00	36.18	1000.0	9.000	N	ON	19.5
12.52	21.04	---	60.00	38.96	1000.0	9.000	N	ON	19.6
12.76	---	18.20	50.00	31.80	1000.0	9.000	N	ON	19.6

Remark: Correct factor=cable loss + LISN factor

N line Conducted Emission from 150 KHz to 30 MHz

Bluetooth LE

During the test, the Conducted Emission was performed in all modes with all channels, Bluetooth LE-Channel 0 are selected as the worst condition. The test data of the worst-case condition was recorded in this report.

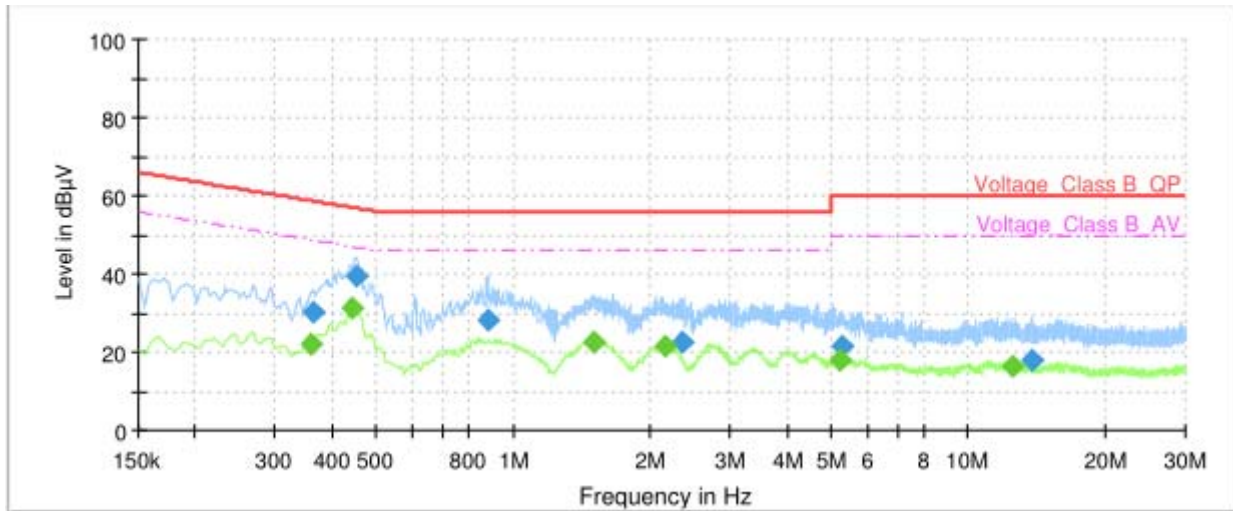

Frequency (MHz)	QuasiPeak (dBµV)	Average (dBµV)	Limit (dBµV)	Margin (dB)	Meas. Time (ms)	Bandwidth (kHz)	Line	Filter	Corr. (dB)
0.36	---	22.13	48.75	26.62	1000.0	9.000	L1	ON	21.0
0.36	30.21	---	58.69	28.48	1000.0	9.000	L1	ON	21.0
0.44	---	31.34	46.97	15.63	1000.0	9.000	L1	ON	20.9
0.45	39.28	---	56.85	17.57	1000.0	9.000	L1	ON	20.9
0.88	28.17	---	56.00	27.83	1000.0	9.000	L1	ON	20.3
1.51	---	22.39	46.00	23.61	1000.0	9.000	L1	ON	19.9
2.16	---	21.36	46.00	24.64	1000.0	9.000	L1	ON	19.7
2.36	22.62	---	56.00	33.38	1000.0	9.000	L1	ON	19.6
5.21	---	17.97	50.00	32.03	1000.0	9.000	L1	ON	19.5
5.28	21.66	---	60.00	38.34	1000.0	9.000	L1	ON	19.5
12.55	---	16.41	50.00	33.59	1000.0	9.000	L1	ON	19.6
13.75	18.12	---	60.00	41.88	1000.0	9.000	L1	ON	19.6

Remark: Correct factor=cable loss + LISN factor

L line Conducted Emission from 150 KHz to 30 MHz

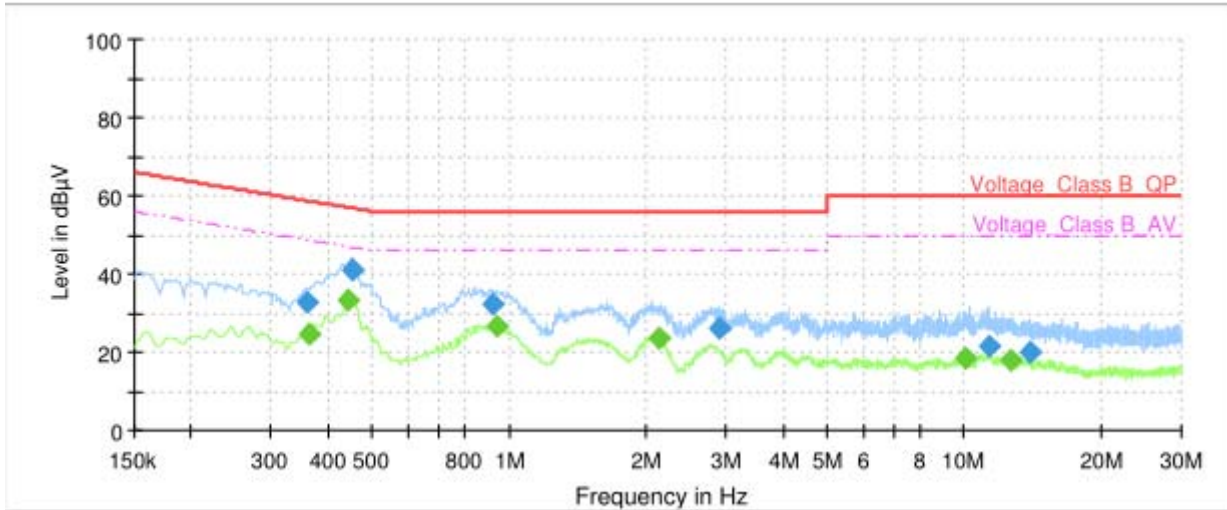

Frequency (MHz)	QuasiPeak (dBµV)	Average (dBµV)	Limit (dBµV)	Margin (dB)	Meas. Time (ms)	Bandwidth (kHz)	Line	Filter	Corr. (dB)
0.36	32.88	---	58.75	25.87	1000.0	9.000	N	ON	21.0
0.36	---	24.49	48.69	24.20	1000.0	9.000	N	ON	21.0
0.44	---	33.21	47.02	13.81	1000.0	9.000	N	ON	20.9
0.45	41.21	---	56.85	15.64	1000.0	9.000	N	ON	20.9
0.92	32.49	---	56.00	23.51	1000.0	9.000	N	ON	20.3
0.94	---	26.65	46.00	19.35	1000.0	9.000	N	ON	20.3
2.14	---	23.74	46.00	22.26	1000.0	9.000	N	ON	19.7
2.89	26.17	---	56.00	29.83	1000.0	9.000	N	ON	19.6
10.09	---	18.52	50.00	31.48	1000.0	9.000	N	ON	19.6
11.29	21.55	---	60.00	38.45	1000.0	9.000	N	ON	19.6
12.64	---	18.17	50.00	31.83	1000.0	9.000	N	ON	19.6
13.91	19.87	---	60.00	40.13	1000.0	9.000	N	ON	19.6

Remark: Correct factor=cable loss + LISN factor

N line Conducted Emission from 150 KHz to 30 MHz

6. Main Test Instruments

Name	Manufacturer	Type	Serial Number	Calibration Date	Expiration Date
Radiated Emission					
EMI Test Receiver	R&S	ESR	102389	2023-05-12	2024-05-11
Signal Analyzer	R&S	FSV40	101186	2023-05-12	2024-05-11
Loop Antenna	SCHWARZBECK	FMZB1519	1519-047	2023-04-16	2026-04-15
TRILOG Broadband Antenna	SCHWARZBECK	VULB 9163	1023	2023-07-14	2026-07-13
Horn Antenna	R&S	HF907	102723	2021-07-24	2024-07-23
Horn Antenna	ETS-Lindgren	3160-09	00102643	2021-10-10	2024-10-09
Software	R&S	EMC32	9.26.01	/	/
Conducted Emission					
Artificial main network	R&S	ENV216	102191	2022-12-13	2024-12-09
EMI Test Receiver	R&S	ESR	101667	2023-05-12	2024-05-11
Software	R&S	EMC32	10.35.10	/	/

ANNEX A: The EUT Appearance

The EUT Appearance are submitted separately.

ANNEX B: Test Setup Photos

The Test Setup Photos are submitted separately.

***** END OF REPORT *****