

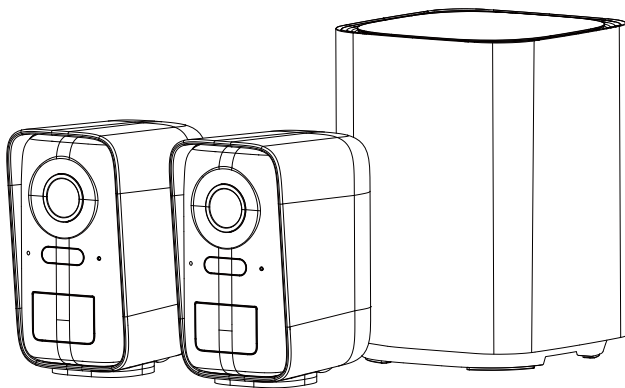

物料名称(Name)	W331 说明书
材质(Material)	封面封底材质:157g铜版纸/哑胶,内页材质:80g哑粉
尺寸(Dimension)	150x110mm,共76P,胶装
印刷(Printing)	80%K
表面工艺(Finish)	/
备注(remarks)	按语种顺序装订:英语、法语、德语

Botslab

Be Secure, Be Botslab



Outdoor Wireless Cameras W331 Quick Start Guide

Table of Contents

English.....	P01-P09
Français.....	P10-P17
德语.....	P10-P17

Packing List

Please check whether the main unit and all accessories are complete upon unpacking.

Camera installation list



Camera x 2

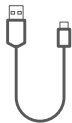

Type-C
cable x 1

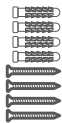

Screw
pack x 1



Warning
sticker x 2



Bracket x 2



待翻译 x 2



Positioning
sticker x 2

Base installation list



Base x 1

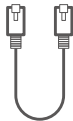

Network
cable x 1

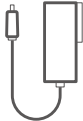

Power
adapter x 1



Quick Start
Guide x 1



power
adapter x 2

Product Appearance

Battery-Powered Camera Appearance

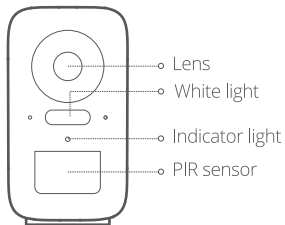
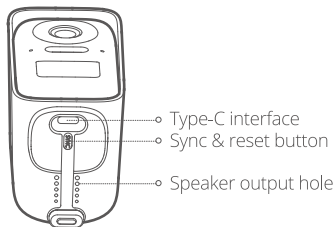

Base Appearance

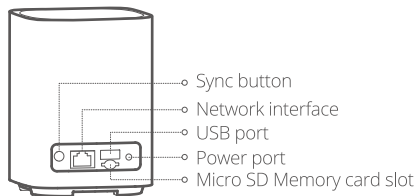
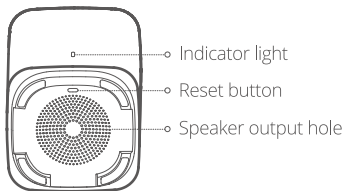

Memory card: Maximum storage of 128 GB

Network Setup Guide

Download and install the APP

Method 1: Scan the QR code below with your mobile phone to download and install the Botslab APP.

Method 2: Search and download the Botslab APP from App Store or Google Play, and then install it.

Launch the Botslab APP and tap the "Sign up" button to create a Botslab account. If you already have an account, tap the "Log in" button and enter your account and password to log in.



Scan untuk mendownload aplikasi **Botslab**



Connection Guide

1. Power on the base.
2. Connect the base to the home router with the provided network cable.
3. When the indicator light is in constant green, the base station is ready for setup.

For the suite containing battery, base, and camera, the battery-powered camera is paired with the base by default. After the base is successfully added to the APP, the sub-device will be displayed automatically.

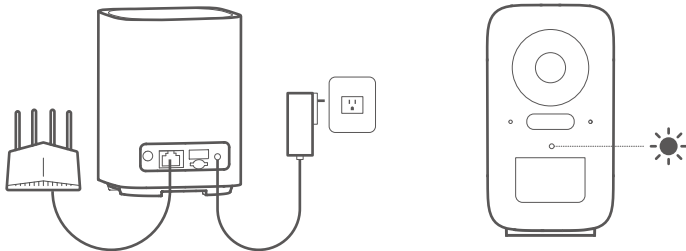

Add the Device

Method 1

1. Open the Botslab app, click the "Register" button to register a Botslab account. If you already have an account, click the "Login" button, and enter your account and password to log in
2. After logging in, click the "+" button on the homepage, enter "Scan" and scan the QR code on the device body. Follow the prompts to add the device (it is recommended to connect via network cable). (Refer to the attached operation instructions)

Method 2:

After logging in, click the "+" button on the homepage and add devices according to their model (see the attached picture for operation guidance)

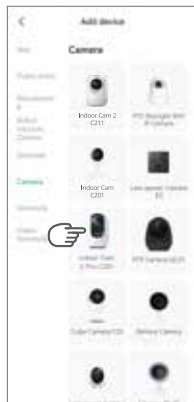

Installation Guide

Place of installation

A WiFi signal strength test is required to find a place to install the battery-powered camera.

1. After adding the base, the wizard for testing the signal strength will pop up. Follow the instructions for installation.
2. To test the WiFi signal strength, bring the battery-powered camera and your mobile phone to a desirable place for installation.
3. Place the camera as close as possible to the base. If the WiFi signal strength is weak, move it to a place with a stronger signal for installation.



Installation angle and height:

1. Hang the battery-powered camera 7 to 10 feet (2 to 3 meters) above the ground without direct sunlight.
2. When installing the battery-powered camera, the height maximizes the detection range of the battery-powered camera's motion sensor. It is not recommended to face the motion sensor to the moving object vertically. Otherwise, the motion event may not be detected. Make sure the included angle between the motion sensor and the measured object is greater than 10 degrees.

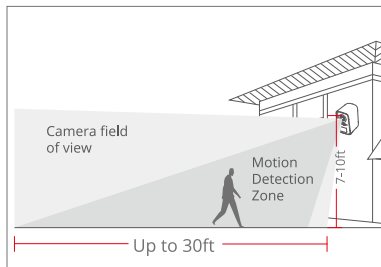

Installing Battery-Powered Camera

Installation Bracket

1. Attach the positioning sticker to the wall in the direction of the bracket base, and drill holes according to the position shown in the diagram.
2. Insert the expansion bolt into the wall at the positioning sticker's hole position.
3. Fix the bracket base with screws.
4. Insert the bracket into the base, and follow the instructions shown in the diagram.

Installing the Camera

1. Screw the camera body onto the bracket, and tighten and align it
2. Use the app to view the image's fixed position, and fix the camera position in place

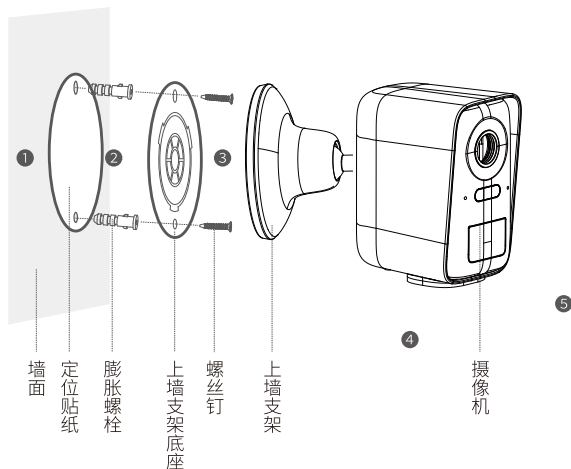

Rechargeable Battery-Powered Camera

Method 1

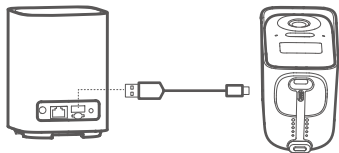

Method 2

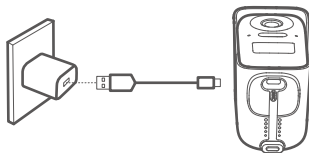

green light is in constant green	green light is off	Charging time
正在充电	充电完成	6 hours

Notes

1. For better night vision imaging, do not use the camera with the front or sides of the lens near reflective materials such as glass and white walls; otherwise, the images of things nearby will be rendered bright while those far away dark or even white.
2. Try to place the device in a place with good network signal reception. The distance between the device and metal objects (e.g., metal supports, metal doors, and windows) or other signal interference sources should not be too close.
3. Do not place the device near the heat source, e.g., electric heater, oven, or stove fire.
4. This product is designed to operate within a temperature range of -25°C to $+45^{\circ}\text{C}$. Do not use this product in environments that are too hot or too cold.

Operating mode description

Battery-powered camera

Indicator colors	Status
Constant blue	Device online
Slowly flashing blue	Upgrading/Someone is checking the camera streaming status
Constant green	Device is charging/ device startup/ device failure
Quickly flashing green	Device is networking/ Device networking successful/ Device upgrade
Slowly flashing green light	Waiting to connect to the network/ Incorrect password for WiFiconnection / Failed to connect to WiFi, or the network is unavailable
Light is off	Fully charged
Solid white light	Control white light on/off remotely
Fast flashing white light	Audio and visual alarm

Base

Indicator colors	Status
Constant green	Base powered on
Quickly flashing green	Device initialization, waiting for WiFi configuration, device offline Device networking/device network connection is successful, but the cloud account has not been bound. The light will quickly flash green until the device is bound to the cloud.
Slowly flashing green	Upgrading
Constant blue	Base online

The manufacturer reserves the right to adjust the functional status of the product through firmware upgrades or software adjustments

Important

Personal information security

For the safety of you and your family, please make sure that the products you purchase are not bound to any unauthorized person. Botslab will take strict measures to protect the information security of you and your family.

Description of Hazardous material Contents

Component	Toxic and Harmful Substances and Elementst					
	Lead(Pb)	Mercury(Hg)	Cadmium(Cd)	Hexavalent Chromium (Cr (VI))	Polybrominsted Biphenyls (PBB)	Polybrominsted DiphenylEthers (PBDE)
Plastic enclosure	○	○	○	○	○	○
Circuit board components	×	○	○	○	○	○
Power cable	×	○	○	○	○	○
Adapter	×	○	○	○	○	○
Lens	○	○	○	○	○	○

This form is prepared in accordance with SJ/T11364.

○ : Indicates that for each item in this produce ,said hazardous substance id below the requirements set forth by the standard GB/T26572.

× : It indicates that the hazardous substance in at least one homogeneous material of this part exceeds the limit specified in GB/T26572. However, it satisfies limit requirements specified in the List of Exempt Applications of Hazardous Substances Identified in the Management Catalog.



Note: A small patch of electronic components for special purposes is marked with "X" in the table (such as high voltage resistors, ceramic resistors, diodes), in which the lead content may exceed 0.1% . As the screws and the core in the data cables using alloy with better performance, the lead content may also be exceed 0.1%. These components are in accordance with the require- ments of the exemption clause of the EU RoHs directive. Limited by the current global technology development, there are no other alternative technologies and components. The external lead contents of these components are in accordance with enviornmental protection requirements.

FCC STATEMENT

This device complies with part 15 of the FCC Rules. Operation is subject to the following two conditions: (1) This device may not cause harmful interference, and (2) this device must accept any interference received, including interference that may cause undesired operation.

This equipment has been tested and found to comply with the limits for a Class B digital device, pursuant to part 15 of the FCC Rules. These limits are designed to provide reasonable protection against harmful interference in a residential installation. This equipment generates uses and can radiate radio frequency energy and, if not installed and used in accordance with the instructions, may cause harmful interference to radio communications. However, there is no guarantee that interference will not occur in a particular installation. If this equipment does cause harmful interference to radio or television reception, which can be determined by turning the equipment off and on, the user is encouraged to try to correct the interference by one or more of the following measures:

Reorient or relocate the receiving antenna.

- Increase the separation between the equipment and receiver.

- Connect the equipment into an outlet on a circuit different from that to which the receiver is connected.

- Consult the dealer or an experienced radio/TV technician for help.

Any Changes or modifications not expressly approved by the party responsible for compliance could void the user's authority to operate the equipment.

This equipment complies with FCC radiation exposure limits set forth for an uncontrolled environment. This equipment should be installed and operated with minimum distance 20cm between the radiator & your body.

IC Caution:

This device contains licence-exempt transmitter(s)/receiver(s) that comply with Innovation, Science and Economic Development Canada's licence-exempt RSS(s). Operation is subject to the following two conditions:

This device may not cause interference.

This device must accept any interference, including interference that may cause undesired operation of the device.

Cet appareil contient des émetteurs/récepteurs exemptés de licence qui sont conformes aux flux RSS exemptés de licence de Innovation, Science et développement économique Canada. L'exploitation est soumise aux deux conditions suivantes: Cet appareil ne doit pas causer d'interférences. Ce dispositif doit accepter toute interférence, y compris toute interférence pouvant causer un fonctionnement indésirable du dispositif.

After-Sales Service

Warranty Policy for Botslab Smart Camera Products

The product, if purchased out of China, will be repaired locally within 1 year from the date of purchase. Please contact the local authorized distributor for details.

Non-Warranty Policy for Botslab Smart Camera Products

- Cannot present valid warranty certificate and purchase invoice.
- Damages caused by usage, maintenance, and storage which are not performed following the product user manual and damages caused by disassembly and repair which are not authorized by Botslab.
- Damages which result of force majeure.
- Normal decoloration and wastage during usage will not be included into warranty service.

Contact Us



<https://www.botslab.com>



service@botslab.com



[Facebook@botslabofficial](#)



1-866-360-0505 (Only for US)
Working time: Mon-Fri, 9:00 - 17:00 EST