

**CFR 47 FCC PART 15 SUBPART C  
ISED RSS-247 ISSUE 2 (DTS)**

**TEST REPORT**

*For*

**Botslab Dual-Lens PTZ Camera**

**MODEL NUMBER: W315**

**REPORT NUMBER: E04A23110780F00402**

**ISSUE DATE: Jan. 22, 2024**

**FCC ID: 2A22Z-W315**

**IC: 27673-W315**

*Prepared for*

**Botslab, Inc.**

**919 North Market Street, Suite 950, Wilmington, New Castle, Delaware, USA**

*Prepared by*

**Guangdong Global Testing Technology Co., Ltd.**

**Room 101-105, 203-210, Building 1, No.2, Keji 8 Road, Songshan Lake Park,  
Dongguan city, Guangdong, People's Republic of China, 523808**

**This report is based on a single evaluation of the submitted sample(s) of the above mentioned  
Product, it does not imply an assessment of the production of the products.**

**This report shall not be reproduced, except in full, without the written approval of Guangdong  
Global Testing Technology Co., Ltd.**

Revision History

<u>Rev.</u>	<u>Issue Date</u>	<u>Revisions</u>	<u>Revised By</u>
<u>V0</u>	<u>Jan. 22, 2024</u>	<u>Initial Issue</u>	<u></u>

### Summary of Test Results

Test Item	Clause	Limit/Requirement	Result
Antenna Requirement	N/A	FCC Part 15.203/15.247 (c) RSS-GEN Clause 6.8	Compliance
AC Power Line Conducted Emission	ANSI C63.10-2013, Clause 6.2	FCC Part 15.207 RSS-GEN Clause 8.8	Pass
Conducted Output Power	ANSI C63.10-2013, Clause 11.9.1.3	FCC Part 15.247 (b)(3) RSS-247 Clause 5.4 (d)	Pass
6dB Bandwidth and 99% Occupied Bandwidth	ANSI C63.10-2013, Clause 11.8.1	FCC Part 15.247 (a)(2) RSS-247 Clause 5.2 (a) ISED RSS-Gen Clause 6.7	Pass
Power Spectral Density	ANSI C63.10-2013, Clause 11.10.2	FCC Part 15.247 (e) RSS-247 Clause 5.2 (b)	Pass
Conducted Band edge and spurious emission	ANSI C63.10-2013, Clause 11.11	FCC Part 15.247(d) RSS-247 Clause 5.5	Pass
Radiated Band edge and Spurious Emission	ANSI C63.10-2013, Clause 11.11 & Clause 11.12	FCC Part 15.247 (d) FCC Part 15.205/15.209 RSS-247 Clause 5.5 RSS-GEN Clause 8.9	Pass
Duty Cycle	ANSI C63.10-2013, Clause 11.6	None; for reporting purposes only.	Pass

\*This test report is only published to and used by the applicant, and it is not for evidence purpose in China.

\*The measurement result for the sample received is <Pass> according to <CFR 47 FCC PART 15 SUBPART C ISED RSS-247 ISSUE 2 (DTS)> when <Accuracy Method> decision rule is applied.

## CONTENTS

<b>1.</b>	<b>ATTESTATION OF TEST RESULTS .....</b>	<b>5</b>
<b>2.</b>	<b>TEST METHODOLOGY .....</b>	<b>6</b>
<b>3.</b>	<b>FACILITIES AND ACCREDITATION .....</b>	<b>6</b>
<b>4.</b>	<b>CALIBRATION AND UNCERTAINTY .....</b>	<b>7</b>
4.1.	<i>MEASURING INSTRUMENT CALIBRATION .....</i>	<i>7</i>
4.2.	<i>MEASUREMENT UNCERTAINTY .....</i>	<i>7</i>
<b>5.</b>	<b>EQUIPMENT UNDER TEST .....</b>	<b>8</b>
5.1.	<i>DESCRIPTION OF EUT .....</i>	<i>8</i>
5.2.	<i>CHANNEL LIST .....</i>	<i>8</i>
5.3.	<i>MAXIMUM AVERAGE EIRP .....</i>	<i>9</i>
5.4.	<i>TEST CHANNEL CONFIGURATION .....</i>	<i>9</i>
5.5.	<i>THE WORSE CASE POWER SETTING PARAMETER .....</i>	<i>9</i>
5.6.	<i>DESCRIPTION OF AVAILABLE ANTENNAS .....</i>	<i>9</i>
5.7.	<i>EUT ACCESSORY .....</i>	<i>9</i>
5.8.	<i>SUPPORT UNITS FOR SYSTEM TEST .....</i>	<i>10</i>
5.9.	<i>SETUP DIAGRAM .....</i>	<i>10</i>
<b>6.</b>	<b>MEASURING EQUIPMENT AND SOFTWARE USED .....</b>	<b>11</b>
<b>7.</b>	<b>ANTENNA PORT TEST RESULTS .....</b>	<b>13</b>
7.1.	<i>Conducted Output Power .....</i>	<i>13</i>
7.2.	<i>6dB Bandwidth and 99% Occupied Bandwidth .....</i>	<i>14</i>
7.3.	<i>Power Spectral Density .....</i>	<i>16</i>
7.4.	<i>Conducted Band edge and spurious emission .....</i>	<i>17</i>
7.5.	<i>Duty Cycle .....</i>	<i>19</i>
<b>8.</b>	<b>RADIATED TEST RESULTS .....</b>	<b>20</b>
8.1.	<i>Radiated Band edge and Spurious Emission .....</i>	<i>26</i>
<b>9.</b>	<b>ANTENNA REQUIREMENT .....</b>	<b>38</b>
<b>10.</b>	<b>AC POWER LINE CONDUCTED EMISSION .....</b>	<b>39</b>
<b>11.</b>	<b>TEST DATA - Appendix A .....</b>	<b>42</b>
	<b>APPENDIX: PHOTOGRAPHS OF TEST CONFIGURATION .....</b>	<b>62</b>
	<b>APPENDIX: PHOTOGRAPHS OF THE EUT .....</b>	<b>63</b>

# 1. ATTESTATION OF TEST RESULTS

## Applicant Information

Company Name: Botslab, Inc.  
 Address: 919 North Market Street, Suite 950, Wilmington, New Castle, Delaware, USA

## Manufacturer Information

Company Name: Botslab, Inc.  
 Address: 919 North Market Street, Suite 950, Wilmington, New Castle, Delaware, USA

## EUT Information

Product Description: Botslab Dual-Lens PTZ Camera  
 Model: W315  
 Series Model: N/A  
 Brand: Botslab  
 Sample Received Date: Nov. 23, 2023  
 Sample Status: Normal  
 Sample ID: A23110780 006  
 Date of Tested: Nov. 23, 2023 to Jan. 22, 2024

APPLICABLE STANDARDS	
STANDARD	TEST RESULTS
CFR 47 FCC PART 15 SUBPART C ISED RSS-247 ISSUE 2 (DTS)	Pass

Prepared By:

*Win Huang*

Win Huang  
 Project Engineer

Checked By:

*Alan He*

Alan He  
 Laboratory Leader

Approved By:

*Shawn Wen*  

Shawn Wen  
 Laboratory Manager

## 2. TEST METHODOLOGY

All tests were performed in accordance with the standard CFR 47 FCC PART 15 SUBPART C ISED RSS-247 ISSUE 2 (DTS)

## 3. FACILITIES AND ACCREDITATION

Accreditation Certificate	<p><b>A2LA (Certificate No.: 6947.01)</b> Guangdong Global Testing Technology Co., Ltd. has been assessed and proved to be in compliance with A2LA.</p> <p><b>FCC (FCC Designation No.: CN1343)</b> Guangdong Global Testing Technology Co., Ltd. has been recognized to perform compliance testing on equipment subject to Supplier's Declaration of Conformity (SDoC) and Certification rules</p> <p><b>ISED (Company No.: 30714)</b> Guangdong Global Testing Technology Co., Ltd. has been registered and fully described in a report filed with ISED. The Company Number is 30714 and the test lab Conformity Assessment Body Identifier (CABID) is CN0148.</p>
---------------------------	--

Note: All tests measurement facilities use to collect the measurement data are located at Room 101-105, 203-210, Building 1, No.2, Keji 8 Road, Songshan Lake Park, Dongguan city, Guangdong, People's Republic of China, 523808

## 4. CALIBRATION AND UNCERTAINTY

### 4.1. MEASURING INSTRUMENT CALIBRATION

The measuring equipment utilized to perform the tests documented in this report has been calibrated in accordance with the manufacturer's recommendations and is traceable to recognized national standards.

### 4.2. MEASUREMENT UNCERTAINTY

Where relevant, the following measurement uncertainty levels have been estimated for tests performed on the apparatus:

Test Items	k	Uncertainty
DTS Bandwidth	1.96	±9.2 PPM
20dB Emission Bandwidth	1.96	±9.2 PPM
Carrier Frequency Separation	1.96	±9.2 PPM
Time of Occupancy	1.96	±0.57%
Conducted Output Power	1.96	±1.5 dB
Power Spectral Density Level	1.96	±1.9 dB
Conducted Spurious Emission	1.96	9 kHz-30 MHz: ± 0.95 dB 30 MHz-1 GHz: ± 1.5 dB 1GHz-12.75GHz: ± 1.8 dB 12.75 GHz-26.5 GHz: ± 2.1dB

Note: This uncertainty represents an expanded uncertainty expressed at approximately the 95% confidence level using a coverage factor of k=1.96.

Test Item	Measurement Frequency Range	K	U(dB)
Conducted emissions from the AC mains power ports (AMN)	150 kHz ~ 30 MHz	2	3.37
Radiated emissions	9 kHz ~ 30 MHz	2	4.16
Radiated emissions	30 MHz ~ 1 GHz	2	3.79
Radiated emissions	1 GHz ~ 18 GHz	2	5.62
Radiated emissions	18 GHz ~ 40 GHz	2	5.54

Note: This uncertainty represents an expanded uncertainty expressed at approximately the 95% confidence level using a coverage factor of k=2.

## 5. EQUIPMENT UNDER TEST

### 5.1. DESCRIPTION OF EUT

EUT Name		Botslab Dual-Lens PTZ Camera
Model		W315
Series Model		N/A
Hardware Version		V1.0
Software Version		20231221
Ratings		DC 12V 1.0A
Power Supply	AC	Power Adapter MODEL: RD1201000-C55-35MGD INPUT: 100-240V~ 50/60Hz 0.6A MAX OUTPUT: 12.0V 1.0A
	DC	12.0V

Frequency Band:	2400 MHz to 2483.5 MHz
Frequency Range:	2402 MHz to 2480 MHz
Bluetooth Version:	Bluetooth 5.0
Bluetooth Mode:	Bluetooth LE
Type of Modulation:	GFSK
Number of Channels:	40
Channel Separation:	2 MHz
Maximum Peak Power:	-0.45 dBm
Antenna Type:	External Antenna
Antenna Gain:	3.50 dBi
Normal Test Voltage:	12 Vdc
EUT Test software:	SecureCRT

### 5.2. CHANNEL LIST

Channel	Frequency (MHz)	Channel	Frequency (MHz)	Channel	Frequency (MHz)	Channel	Frequency (MHz)
0	2402	11	2424	22	2446	33	2468
1	2404	12	2426	23	2448	34	2470
2	2406	13	2428	24	2450	35	2472
3	2408	14	2430	25	2452	36	2474
4	2410	15	2432	26	2454	37	2476
5	2412	16	2434	27	2456	38	2478
6	2414	17	2436	28	2458	39	2480
7	2416	18	2438	29	2460	/	/
8	2418	19	2440	30	2462	/	/
9	2420	20	2442	31	2464	/	/
10	2422	21	2444	32	2468	/	/



**5.3. MAXIMUM AVERAGE EIRP**

Test Mode	Frequency (MHz)	Channel Number	Maximum Peak Output Power (dBm)	Maximum EIRP (dBm)
LE 1Mbps	2402 ~ 2480	0-39[40]	-0.45	3.05

**5.4. TEST CHANNEL CONFIGURATION**

Test Mode	Test Channel	Frequency
LE 1Mbps	CH 0(Low Channel), CH 19(MID Channel), CH 39(High Channel)	2402 MHz, 2440 MHz, 2480 MHz

**5.5. THE WORSE CASE POWER SETTING PARAMETER**

The Worse Case Power Setting Parameter under 2400 ~ 2483.5MHz Band				
Test Software Version		SecureCRT		
Modulation Type	Transmit Antenna Number	Test Software setting value		
		CH 0	CH 19	CH 39
GFSK(1Mbps)	1	default	default	default

**5.6. DESCRIPTION OF AVAILABLE ANTENNAS**

Antenna	Frequency (MHz)	Antenna Type	MAX Antenna Gain (dBi)
1	2402-2480	External	3.50

Test Mode	Transmit and Receive Mode	Description
LE 1Mbps	<input checked="" type="checkbox"/> 1TX, 1RX	Antenna 1 can be used as transmitting/receiving antenna.
Note:		

Note: The value of the antenna gain was declared by customer.

**5.7. EUT ACCESSORY**

Adapter	
Model No.:	RD1201000-C55-35MGD
Input:	100-240V~ 50/60Hz 0.6A MAX
Output:	12.0V 1.0A
AC Cable:	N/A

DC Cable:	3.05 Meter
-----------	------------

Cable	
Accessory:	DC cable
Model No.:	N/A
Description:	DC Cable
Cable Type:	Unshielded without ferrite; Unshielded with two ferrite
Length:	0.53Meter

**5.8. SUPPORT UNITS FOR SYSTEM TEST**

The EUT has been tested as an independent unit

**5.9. SETUP DIAGRAM**

Radiated emissions:

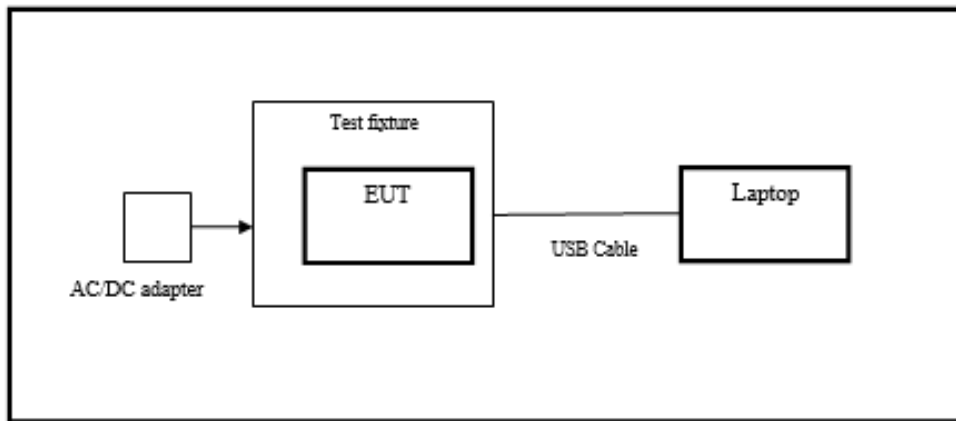

## 6. MEASURING EQUIPMENT AND SOFTWARE USED

Test Equipment of Conducted RF					
Equipment	Manufacturer	Model No.	Serial No.	Last Cal.	Due Date
Spectrum Analyzer	Rohde & Schwarz	FSV40	102257	2023/09/18	2024/09/17
Spectrum Analyzer	KEYSIGHT	N9020A	MY51285127	2023/09/18	2024/09/17
EXG Analog Signal Generator	KEYSIGHT	N5173B	MY61253075	2023/09/18	2024/09/17
Vector Signal Generator	Rohde & Schwarz	SMM100A	101899	2023/09/18	2024/09/17
RF Control box	MWRF-test	MW100-RFCB	MW220926GTG	2023/09/18	2024/09/17
Wideband Radio Communication Tester	Rohde & Schwarz	CMW270	102792	2023/09/18	2024/09/17
Wideband Radio Communication Tester	Rohde & Schwarz	CMW500	103235	2023/09/18	2024/09/17
temperature humidity chamber	Espec	SH-241	SH-241-2014	2023/09/18	2024/09/17
RF Test Software	MWRF-test	MTS8310E (Ver. V2/0)	N/A	N/A	N/A

Test Equipment of Radiated emissions below 1GHz					
Equipment	Manufacturer	Model No.	Serial No.	Last Cal.	Due Date
3m Semi-anechoic Chamber	ETS	9m*6m*6m	Q2146	2022/08/30	2025/08/29
EMI Test Receiver	Rohde & Schwarz	ESCI3	101409	2023/09/18	2024/09/17
Spectrum Analyzer	KEYSIGHT	N9020A	MY51283932	2023/09/18	2024/09/17
Pre-Amplifier	HZEMC	HPA-9K0130	HYP A21001	2023/09/18	2024/09/17
Biconilog Antenna	Schwarzbeck	VULB 9168	01315	2022/10/10	2025/10/09
Biconilog Antenna	ETS	3142E	00243646	2022/03/23	2025/03/22
Loop Antenna	ETS	6502	243668	2022/03/30	2025/03/29
Test Software	Farad	EZ-EMC (Ver.FA-03A2 RE)	N/A	N/A	N/A

Test Equipment of Radiated emissions above 1GHz					
Equipment	Manufacturer	Model No.	Serial No.	Last Cal.	Due Date
3m Semi-anechoic Chamber	ETS	9m*6m*6m	Q2149	2022/08/30	2025/08/29
Spectrum Analyzer	Rohde & Schwarz	FSV40	101413	2023/09/18	2024/09/17
Spectrum Analyzer	KEYSIGHT	N9020A	MY51283932	2023/09/18	2024/09/17
Pre-Amplifier	A-INFO	HPA-1G1850	HYP A21003	2023/09/18	2024/09/17
Horn antenna	A-INFO	3117	246069	2022/03/11	2025/03/10
Pre-Amplifier	ZKJC	HPA-184057	HYP A21004	2023/09/18	2024/09/17

Horn antenna	ZKJC	3116C	246265	2022/03/29	2025/03/28
Test Software	Farad	EZ-EMC (Ver.FA-03A2 RE+)	N/A	N/A	N/A

<b>Test Equipment of Conducted emissions</b>					
<b>Equipment</b>	<b>Manufacturer</b>	<b>Model No.</b>	<b>Serial No.</b>	<b>Last Cal.</b>	<b>Due Date</b>
Shielded Room	CHENG YU	8m*5m*4m	N/A	2022/10/29	2025/10/28
EMI Test Receiver	Rohde & Schwarz	ESR3	102647	2023/09/18	2024/09/17
LISN/AMN	Rohde & Schwarz	ENV216	102843	2023/09/18	2024/09/17
NNLK 8129 RC	Schwarzbeck	NNLK 8129 RC	5046	2023/09/18	2024/09/17
Test Software	Farad	EZ-EMC (Ver. EMC-con-3A1 1+)	N/A	N/A	N/A

## 7. ANTENNA PORT TEST RESULTS

### 7.1. CONDUCTED OUTPUT POWER

#### LIMITS

CFR 47 FCC Part15 (15.247) Subpart C ISED RSS-247 ISSUE 2			
Section	Test Item	Limit	Frequency Range (MHz)
CFR 47 FCC 15.247(b)(3) ISED RSS-247 5.4 (d)	Peak Conduct Output Power	1 watt or 30 dBm	2400-2483.5

#### TEST PROCEDURE

Connect the EUT to a low loss RF cable from the antenna port to the power sensor (video bandwidth is greater than the occupied bandwidth).

Measure peak emission level, the indicated level is the peak output power, after any corrections for external attenuators and cables.

#### TEST SETUP

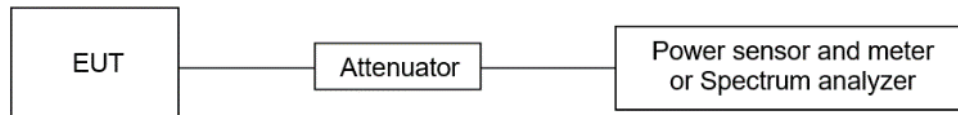

#### TEST ENVIRONMENT

Temperature	23.5°C	Relative Humidity	49%
Atmosphere Pressure	101kPa		

#### TEST RESULTS

Please refer to section "Test Data" - Appendix A

## 7.2. 6DB BANDWIDTH AND 99% OCCUPIED BANDWIDTH

### LIMITS

CFR 47 FCC Part15 (15.247) Subpart C ISED RSS-247 ISSUE 2			
Section	Test Item	Limit	Frequency Range (MHz)
CFR 47 FCC 15.247(a)(2) ISED RSS-247 5.2 (a)	6 dB Bandwidth	≥ 500 kHz	2400-2483.5
ISED RSS-Gen Clause 6.7	99 % Occupied Bandwidth	For reporting purposes only.	2400-2483.5

### TEST PROCEDURE

Refer to ANSI C63.10-2013 clause 11.8 for DTS bandwidth and clause 6.9 for Occupied Bandwidth.

Connect the EUT to the spectrum analyser and use the following settings:

Center Frequency	The center frequency of the channel under test
Frequency Span	For 6 dB Bandwidth: Enough to capture all products of the modulation carrier emission For 99 % Occupied Bandwidth: Between 1.5 times and 5.0 times the OBW
Detector	Peak
RBW	For 6 dB Bandwidth: 100 kHz For 99 % Occupied Bandwidth: 1 % to 5 % of the occupied bandwidth
VBW	For 6 dB Bandwidth: $\geq 3 \times \text{RBW}$ For 99 % Occupied Bandwidth: $\geq 3 \times \text{RBW}$
Trace	Max hold
Sweep	Auto couple

a) Use the 99 % power bandwidth function of the instrument, allow the trace to stabilize and report the measured bandwidth.

b) Allow the trace to stabilize and measure the maximum width of the emission that is constrained by the frequencies associated with the two outermost amplitude points (upper and lower frequencies) that are attenuated by 6 dB relative to the maximum level measured in the fundamental emission.

**TEST SETUP**

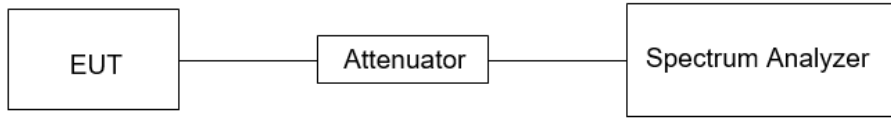

**TEST ENVIRONMENT**

Temperature	23.5°C	Relative Humidity	49%
Atmosphere Pressure	101kPa		

**TEST RESULTS**

Please refer to section "Test Data" - Appendix A

### 7.3. POWER SPECTRAL DENSITY

#### LIMITS

CFR 47 FCC Part15 (15.247) Subpart C ISED RSS-247 ISSUE 2			
Section	Test Item	Limit	Frequency Range (MHz)
CFR 47 FCC §15.247 (e) ISED RSS-247 5.2 (b)	Power Spectral Density	8 dBm in any 3 kHz band	2400-2483.5

#### TEST PROCEDURE

Refer to ANSI C63.10-2013 clause 11.10.

Connect the EUT to the spectrum analyser and use the following settings:

Center Frequency	The center frequency of the channel under test
Detector	PEAK
RBW	$3 \text{ kHz} \leq \text{RBW} \leq 100 \text{ kHz}$
VBW	$\geq 3 \times \text{RBW}$
Span	1.5 x DTS bandwidth
Trace	Max hold
Sweep time	Auto couple

Allow trace to fully stabilize and use the peak marker function to determine the maximum amplitude level within the RBW.

If measured value exceeds limit, reduce RBW (no less than 3 kHz) and repeat.

#### TEST SETUP

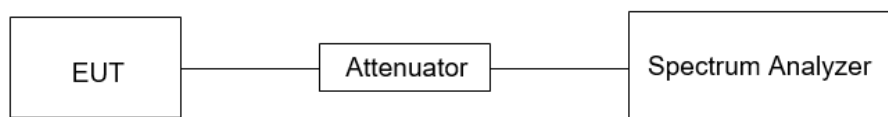

#### TEST ENVIRONMENT

Temperature	23.5°C	Relative Humidity	49%
Atmosphere Pressure	101kPa		

#### TEST RESULTS

Please refer to section "Test Data" - Appendix A



## 7.4. CONDUCTED BAND EDGE AND SPURIOUS EMISSION

### LIMITS

CFR 47 FCC Part15 (15.247) Subpart C ISED RSS-247 ISSUE 2		
Section	Test Item	Limit
CFR 47 FCC §15.247 (d) ISED RSS-247 5.5	Conducted Bandedge and Spurious Emissions	at least 20 dB below that in the 100 kHz bandwidth within the band that contains the highest level of the desired power

### TEST PROCEDURE

Refer to ANSI C63.10-2013 clause 11.11 and 11.13.

Connect the EUT to the spectrum analyser and use the following settings for reference level measurement:

Center Frequency	The center frequency of the channel under test
Detector	Peak
RBW	100 kHz
VBW	$\geq 3 \times \text{RBW}$
Span	1.5 x DTS bandwidth
Trace	Max hold
Sweep time	Auto couple.

Allow trace to fully stabilize and use the peak marker function to determine the maximum PSD level.

Change the settings for emission level measurement:

Span	Set the center frequency and span to encompass frequency range to be measured
Detector	Peak
RBW	100 kHz
VBW	$\geq 3 \times \text{RBW}$
measurement points	$\geq \text{span}/\text{RBW}$
Trace	Max hold
Sweep time	Auto couple.

Allow trace to fully stabilize and use the peak marker function to determine the maximum PSD level. Ensure that the amplitude of all unwanted emissions outside of the authorized frequency band (excluding restricted frequency bands) is attenuated by at least the minimum requirements specified in 11.11.

**TEST SETUP**

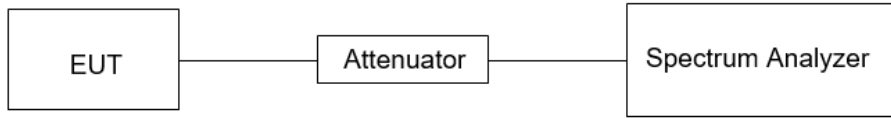

**TEST ENVIRONMENT**

Temperature	23.5°C	Relative Humidity	49%
Atmosphere Pressure	101kPa		

**TEST RESULTS**

Please refer to section "Test Data" - Appendix A

## 7.5. DUTY CYCLE

### LIMITS

None; for reporting purposes only.

### TEST PROCEDURE

Refer to ANSI C63.10-2013 clause 11.6 Zero – Span Spectrum Analyzer method.

### TEST SETUP

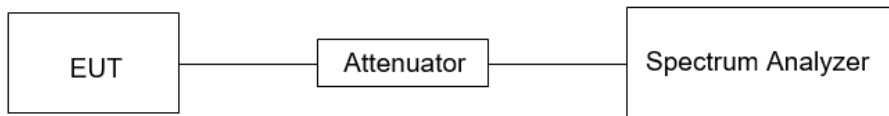

### TEST ENVIRONMENT

Temperature	23.5°C	Relative Humidity	49%
Atmosphere Pressure	101kPa		

### TEST RESULTS

Please refer to section "Test Data" - Appendix B

## 8. RADIATED TEST RESULTS

### LIMITS

Please refer to CFR 47 FCC §15.205 and §15.209.

Please refer to ISED RSS-GEN Clause 8.9 and Clause 8.10.

Radiation Disturbance Test Limit for FCC (Class B) (9 kHz ~ 1 GHz)

Emissions radiated outside of the specified frequency bands above 30 MHz			
Frequency Range (MHz)	Field Strength Limit (uV/m) at 3 m	Field Strength Limit (dBuV/m) at 3 m	
		Quasi-Peak	
30 - 88	100	40	
88 - 216	150	43.5	
216 - 960	200	46	
Above 960	500	54	
Above 1000	500	Peak	Average
		74	54

FCC Emissions radiated outside of the specified frequency bands below 30 MHz		
Frequency (MHz)	Field strength (microvolts/meter)	Measurement distance (meters)
0.009-0.490	2400/F(kHz)	300
0.490-1.705	24000/F(kHz)	30
1.705-30.0	30	30

ISED General field strength limits at frequencies below 30 MHz

Table 6 – General field strength limits at frequencies below 30 MHz		
Frequency	Magnetic field strength (H-Field) (µA/m)	Measurement distance (m)
9 - 490 kHz <sup>Note 1</sup>	6.37/F (F in kHz)	300
490 - 1705 kHz	63.7/F (F in kHz)	30
1.705 - 30 MHz	0.08	30

**Note 1:** The emission limits for the ranges 9-90 kHz and 110-490 kHz are based on measurements employing a linear average detector.

ISED Restricted bands please refer to ISED RSS-GEN Clause 8.10

Table 7 – Restricted frequency bands <sup>Note 1</sup>		
MHz	MHz	GHz
0.090 - 0.110	149.9 - 150.05	9.0 - 9.2
0.495 - 0.505	156.52475 - 156.52525	9.3 - 9.5
2.1735 - 2.1905	156.7 - 156.9	10.6 - 12.7
3.020 - 3.026	162.0125 - 167.17	13.25 - 13.4
4.125 - 4.128	167.72 - 173.2	14.47 - 14.5
4.17725 - 4.17775	240 - 285	15.35 - 16.2
4.20725 - 4.20775	322 - 335.4	17.7 - 21.4
5.677 - 5.683	399.9 - 410	22.01 - 23.12
6.215 - 6.218	608 - 614	23.6 - 24.0
6.26775 - 6.26825	960 - 1427	31.2 - 31.8
6.31175 - 6.31225	1435 - 1626.5	36.43 - 36.5
8.291 - 8.294	1645.5 - 1646.5	Above 38.6
8.362 - 8.366	1660 - 1710	
8.37625 - 8.38675	1718.8 - 1722.2	
8.41425 - 8.41475	2200 - 2300	
12.29 - 12.293	2310 - 2390	
12.51975 - 12.52025	2483.5 - 2500	
12.57675 - 12.57725	2655 - 2900	
13.36 - 13.41	3260 - 3267	
16.42 - 16.423	3332 - 3339	
16.89475 - 16.89525	3345.8 - 3358	
16.80425 - 16.80475	3500 - 4400	
25.5 - 25.67	4500 - 5150	
37.5 - 38.25	5350 - 5460	
73 - 74.6	7250 - 7750	
74.8 - 75.2	8025 - 8500	
108 - 138		

**Note 1:** Certain frequency bands listed in table 7 and in bands above 38.6 GHz are designated for licence-exempt applications. These frequency bands and the requirements that apply to related devices are set out in the 200 and 300 series of RSSs.

FCC Restricted bands of operation refer to FCC §15.205 (a):

MHz	MHz	MHz	GHz
0.090-0.110	16.42-16.423	399.9-410	4.5-5.15
<sup>1</sup> 0.495-0.505	16.69475-16.69525	608-614	5.35-5.46
2.1735-2.1905	16.80425-16.80475	960-1240	7.25-7.75
4.125-4.128	25.5-25.67	1300-1427	8.025-8.5
4.17725-4.17775	37.5-38.25	1435-1626.5	9.0-9.2
4.20725-4.20775	73-74.6	1645.5-1646.5	9.3-9.5
6.215-6.218	74.8-75.2	1660-1710	10.6-12.7
6.26775-6.26825	108-121.94	1718.8-1722.2	13.25-13.4
6.31175-6.31225	123-138	2200-2300	14.47-14.5
8.291-8.294	149.9-150.05	2310-2390	15.35-16.2
8.362-8.366	156.52475-156.52525	2483.5-2500	17.7-21.4
8.37625-8.38675	156.7-156.9	2690-2900	22.01-23.12
8.41425-8.41475	162.0125-167.17	3260-3267	23.6-24.0
12.29-12.293	167.72-173.2	3332-3339	31.2-31.8
12.51975-12.52025	240-285	3345.8-3358	36.43-36.5
12.57675-12.57725	322-335.4	3600-4400	( <sup>2</sup> )
13.36-13.41			

Note: <sup>1</sup>Until February 1, 1999, this restricted band shall be 0.490-0.510 MHz.  
<sup>2</sup>Above 38.6c

**TEST PROCEDURE**

Below 30 MHz

The setting of the spectrum analyser

RBW	200 Hz (From 9 kHz to 0.15 MHz)/ 9 kHz (From 0.15 MHz to 30 MHz)
VBW	200 Hz (From 9 kHz to 0.15 MHz)/ 9 kHz (From 0.15 MHz to 30 MHz)
Sweep	Auto

1. The testing follows the guidelines in ANSI C63.10-2013 clause 6.4.
2. The EUT was arranged to its worst case and then turntable (from 0 degree to 360 degrees) to find the maximum reading. A pre-amp and a high pass filter are used for the test in order to get better signal level. Both Horizontal, Face-on and Face-off polarizations of the antenna are set to make the measurement.
3. The EUT was placed on a turntable with 80 cm above ground.
4. The EUT was set 3 meters from the interference receiving antenna, which was mounted on the top of a 1 m height antenna tower.
5. The radiated emission limits are based on measurements employing a CISPR quasi-peak detector except for the frequency bands 9-90 kHz, 110-490 kHz and above 1000 MHz Radiated emission limits in these three bands are based on measurements employing an average detector.
6. For measurement below 1 GHz, the initial step in collecting conducted emission data is a spectrum analyzer peak detector mode pre-scanning the measurement frequency range. Significant peaks are then marked and then Quasi Peak and average detector mode re-measured. If the emission level of the EUT measured by the peak detector is 3 dB lower than the applicable limit, the peak emission level will be reported. Otherwise, the emission measurement will be repeated using the quasi-peak and average detector and reported.
7. Although these tests were performed other than open field site, adequate comparison measurements were confirmed against 30m open field site. Therefore sufficient tests were made to demonstrate that the alternative site produces results that correlate with the ones of tests made in an open field site based on KDB 414788.
8. The limits in CFR 47, Part 15, Subpart C, paragraph 15.209 (a), are identical to those in RSS-GEN Section 8.9, Table 6, since the measurements are performed in terms of magnetic field strength and converted to electric field strength levels (as reported in the table) using the free space impedance of 377Ω. For example, the measurement frequency X KHz resulted in a level of Y dBuV/m, which is equivalent to  $Y-51.5 = Z$  dBuA/m, which has the same margin, W dB, to the corresponding RSS-GEN Table 6 limit as it has to be 15.209(a) limit.

Below 1 GHz and above 30 MHz

The setting of the spectrum analyser

RBW	120 kHz
VBW	300 kHz
Sweep	Auto
Detector	Peak/QP
Trace	Max hold

1. The testing follows the guidelines in ANSI C63.10-2013 clause 6.5.

2. The EUT was arranged to its worst case and then tune the antenna tower (from 1 m to 4 m) and turntable (from 0 degree to 360 degrees) to find the maximum reading. A pre-amp and a high pass filter are used for the test in order to get better signal level. Both horizontal and vertical polarizations of the antenna are set to make the measurement.
3. The EUT was placed on a turntable with 80 cm above ground.
4. The EUT was set 3 meters from the interference receiving antenna, which was mounted on the top of a variable height antenna tower.
5. For measurement below 1 GHz, the initial step in collecting conducted emission data is a spectrum analyzer peak detector mode pre-scanning the measurement frequency range. Significant peaks are then marked and then Quasi Peak detector mode re-measured. If the emission level of the EUT measured by the peak detector is 3 dB lower than the applicable limit, the peak emission level will be reported. Otherwise, the emission measurement will be repeated using the quasi-peak detector and reported.

Above 1G

The setting of the spectrum analyser

RBW	1 MHz
VBW	PEAK: 3 MHz AVG: see note 6
Sweep	Auto
Detector	Peak
Trace	Max hold

1. The testing follows the guidelines in ANSI C63.10-2013 clause 6.6.
2. The EUT was arranged to its worst case and then tune the antenna tower (from 1 m to 4 m) and turntable (from 0 degree to 360 degrees) to find the maximum reading. A pre-amp and a high pass filter are used for the test in order to get better signal level. Both horizontal and vertical polarizations of the antenna are set to make the measurement.
3. The EUT was placed on a turntable with 1.5 m above ground.
4. The EUT was set 3 meters from the interference receiving antenna, which was mounted on the top of a variable height antenna tower.
5. For measurement above 1 GHz, the emission measurement will be measured by the peak detector. This peak level, once corrected, must comply with the limit specified in Section 15.209.
6. For measurements above 1 GHz the resolution bandwidth is set to 1 MHz, then the video bandwidth is set to 3 MHz for peak measurements and 1 MHz resolution bandwidth with 1/T video bandwidth with peak detector for average measurements. For the Duty Cycle please refer to clause 7.1.ON TIME AND DUTY CYCLE.

X axis, Y axis, Z axis positions:

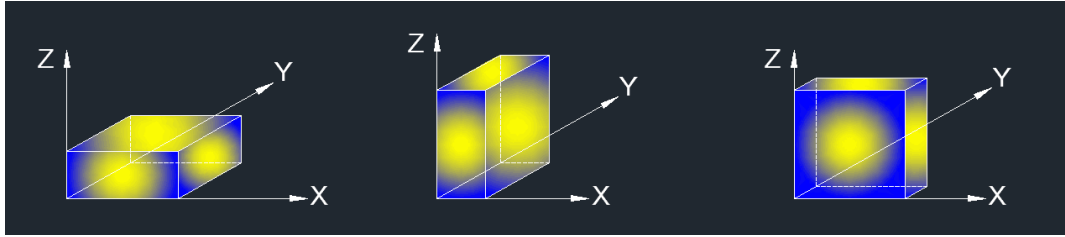

Note 1: For all radiated test, EUT in each of three orthogonal axis emissions had been tested, but only the worst case (X axis) data recorded in the report.

**TEST SETUP**

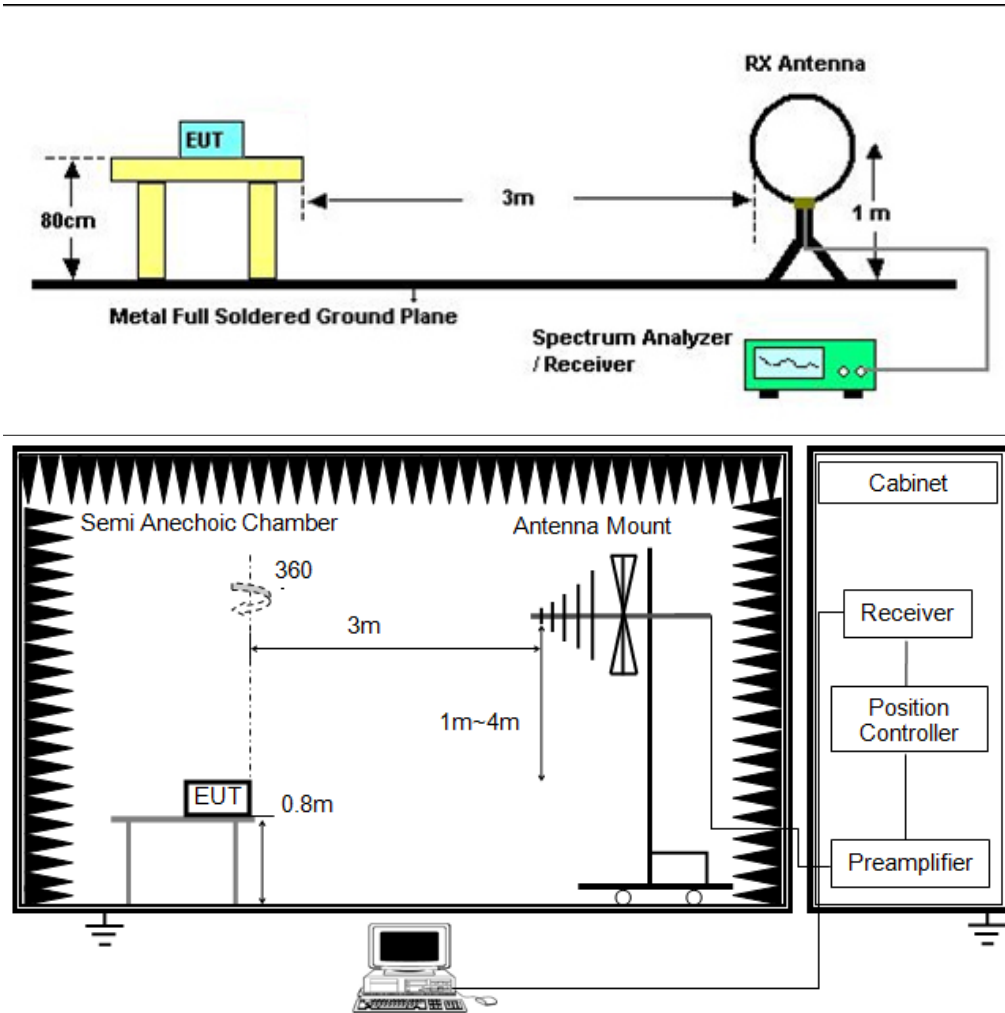



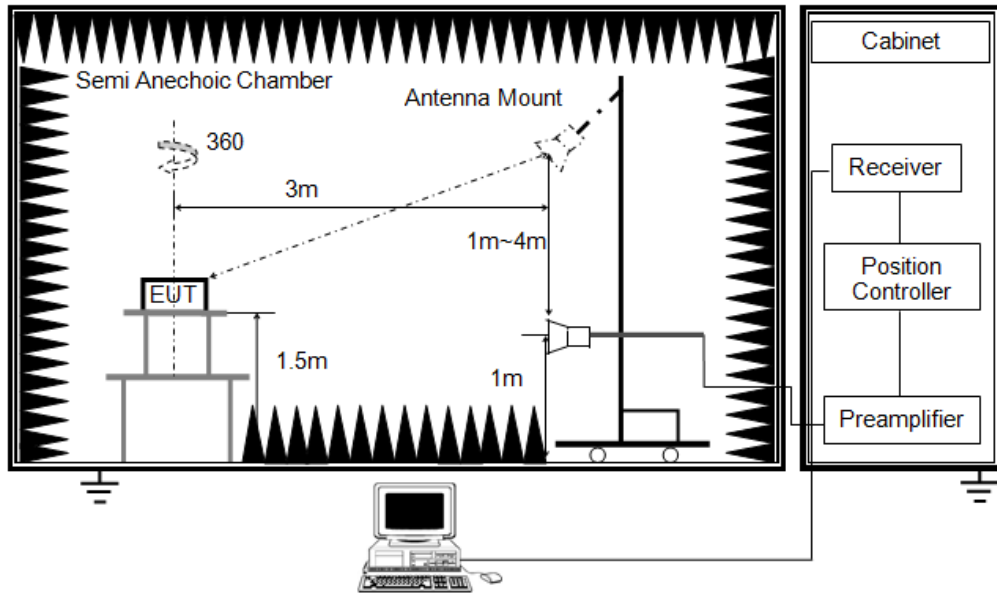

**TEST ENVIRONMENT**

Temperature	24.3°C	Relative Humidity	54%
Atmosphere Pressure	101kPa		

**TEST RESULTS**

### 8.1. RADIATED BAND EDGE AND SPURIOUS EMISSION

- 30MHz to 1GHz

The worst result as bellow:

Mode:	BLE 2402
Power:	AC120/60Hz
TE:	Big
Date	2023/11/27
T/A/P	24.3°C/54%/101Kpa

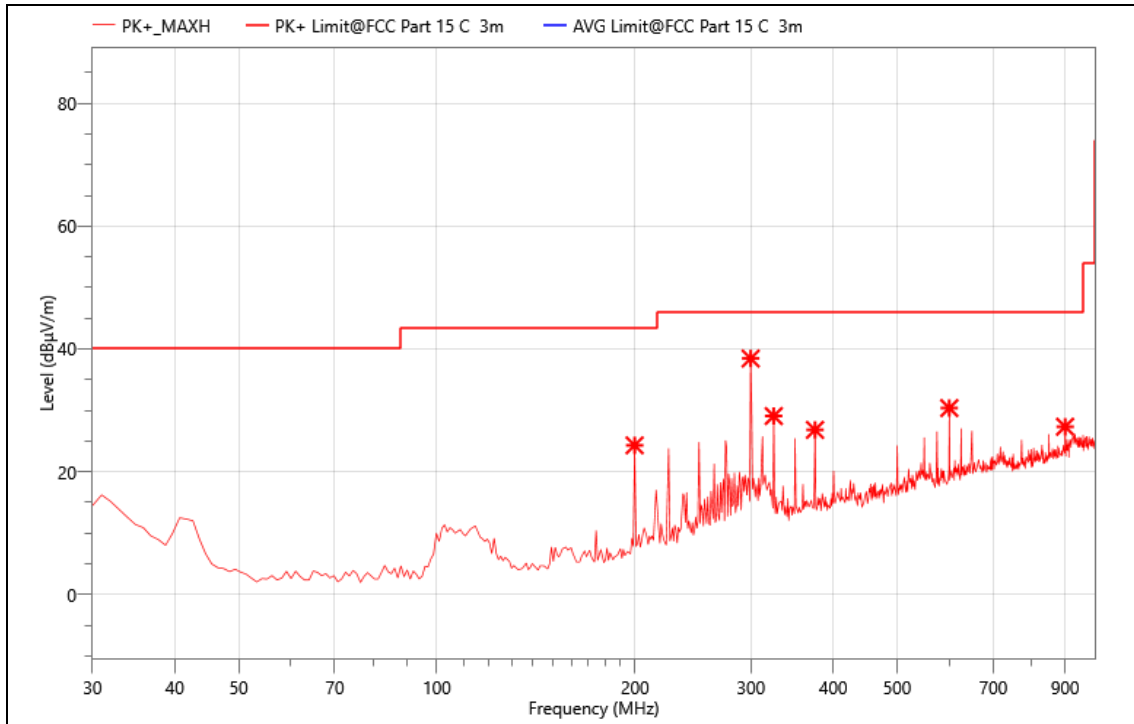

#### Critical\_Freqs

No.	Freq. (MHz)	Reading (dBµV)	Meas. (dBµV/m)	Limit (dBµV/m)	Margin (dBµV/m)	Det.	Pol.	Corr. (dB)
1	199.750	46.38	24.30	43.50	19.20	PK+	H	-22.08
2	299.660	57.30	38.44	46.00	7.56	PK+	H	-18.86
3	324.880	46.67	29.07	46.00	16.93	PK+	H	-17.6
4	375.320	41.92	26.82	46.00	19.18	PK+	H	-15.1
5	600.360	40.26	30.37	46.00	15.63	PK+	H	-9.89
6	900.090	32.43	27.33	46.00	18.67	PK+	H	-5.1

Mode:	BLE 2402
Power:	AC120/60Hz
TE:	Big
Date	2023/11/27
T/A/P	24.3°C/54%/101Kpa

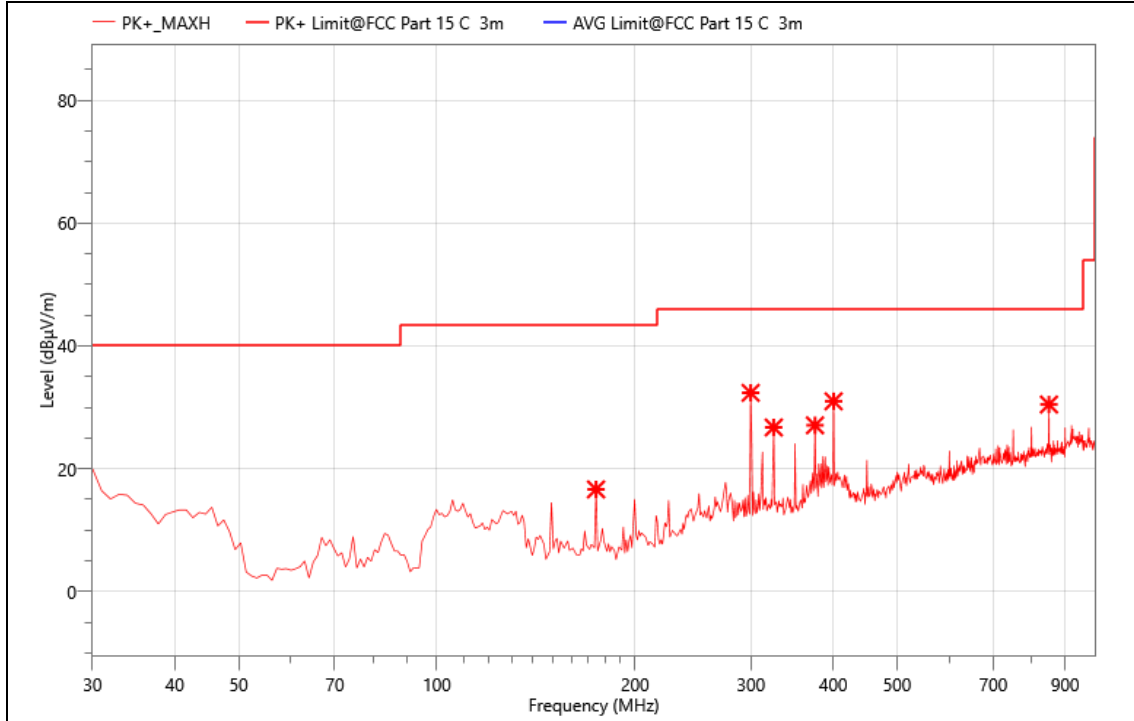

### Critical\_Freqs

No.	Freq. (MHz)	Reading (dBµV)	Meas. (dBµV/m)	Limit (dBµV/m)	Margin (dBµV/m)	Det.	Pol.	Corr. (dB)
1	174.530	38.93	16.63	43.50	26.87	PK+	V	-22.3
2	299.660	51.22	32.36	46.00	13.64	PK+	V	-18.86
3	324.880	44.32	26.72	46.00	19.28	PK+	V	-17.6
4	375.320	42.17	27.07	46.00	18.93	PK+	V	-15.1
5	400.540	44.91	30.99	46.00	15.01	PK+	V	-13.92
6	850.620	36.13	30.46	46.00	15.54	PK+	V	-5.67

● Above 1GHz

The worst result as bellow:

Mode:	BLE 2402
Power:	AC120/60Hz
TE:	Big
Date	2023/11/27
T/A/P	24.3°C/54%/101Kpa

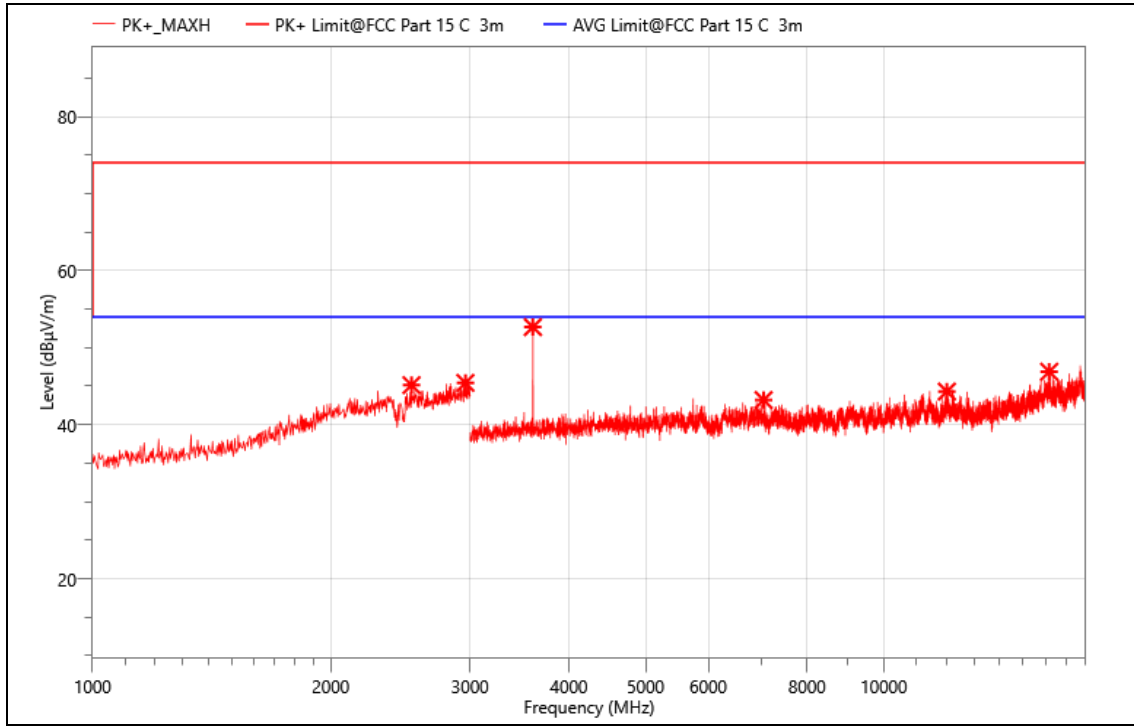

**Critical\_Freqs**

No.	Freq. (MHz)	Reading (dBµV)	Meas. (dBµV/m)	Limit (dBµV/m)	Margin (dBµV/m)	Det.	Pol.	Corr. (dB)
1	2530.000	53.78	45.14	74.00	28.86	PK+	H	-8.64
2	2960.000	52.77	45.43	74.00	28.57	PK+	H	-7.34
3	3601.500	66.57	52.67	74.00	21.33	PK+	H	-13.9
4	7048.500	50.83	43.20	74.00	30.80	PK+	H	-7.63
5	12015.000	48.14	44.30	74.00	29.70	PK+	H	-3.84
6	16183.500	46.94	46.88	74.00	27.12	PK+	H	-0.06

Mode:	BLE 2402
Power:	AC120/60Hz
TE:	Big
Date	2023/11/27
T/A/P	24.3°C/54%/101Kpa

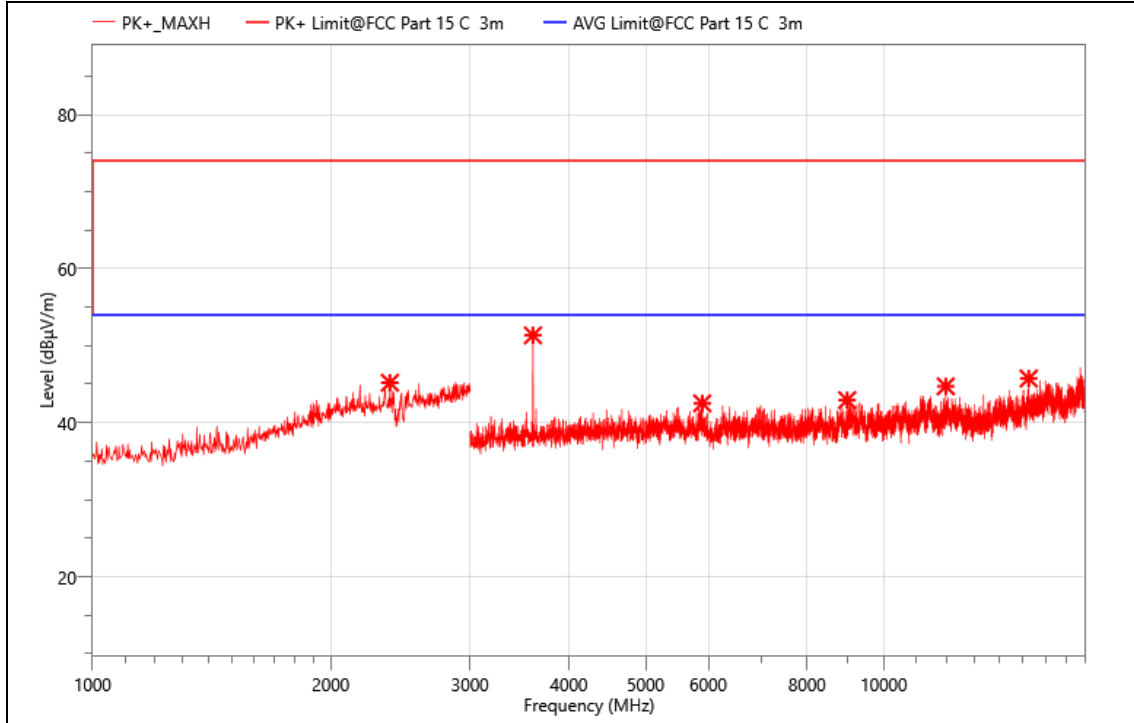

**Critical\_Freqs**

No.	Freq. (MHz)	Reading (dBµV)	Meas. (dBµV/m)	Limit (dBµV/m)	Margin (dBµV/m)	Det.	Pol.	Corr. (dB)
1	2376.000	53.69	45.19	74.00	28.81	PK+	V	-8.5
2	3603.000	65.23	51.34	74.00	22.66	PK+	V	-13.89
3	5896.500	50.99	42.51	74.00	31.49	PK+	V	-8.48
4	8989.500	50.86	42.93	74.00	31.07	PK+	V	-7.93
5	11977.500	49.20	44.72	74.00	29.28	PK+	V	-4.48
6	15246.000	48.53	45.74	74.00	28.26	PK+	V	-2.79

Mode:	BLE 2440
Power:	AC120/60Hz
TE:	Big
Date	2023/11/27
T/A/P	24.3°C/54%/101Kpa

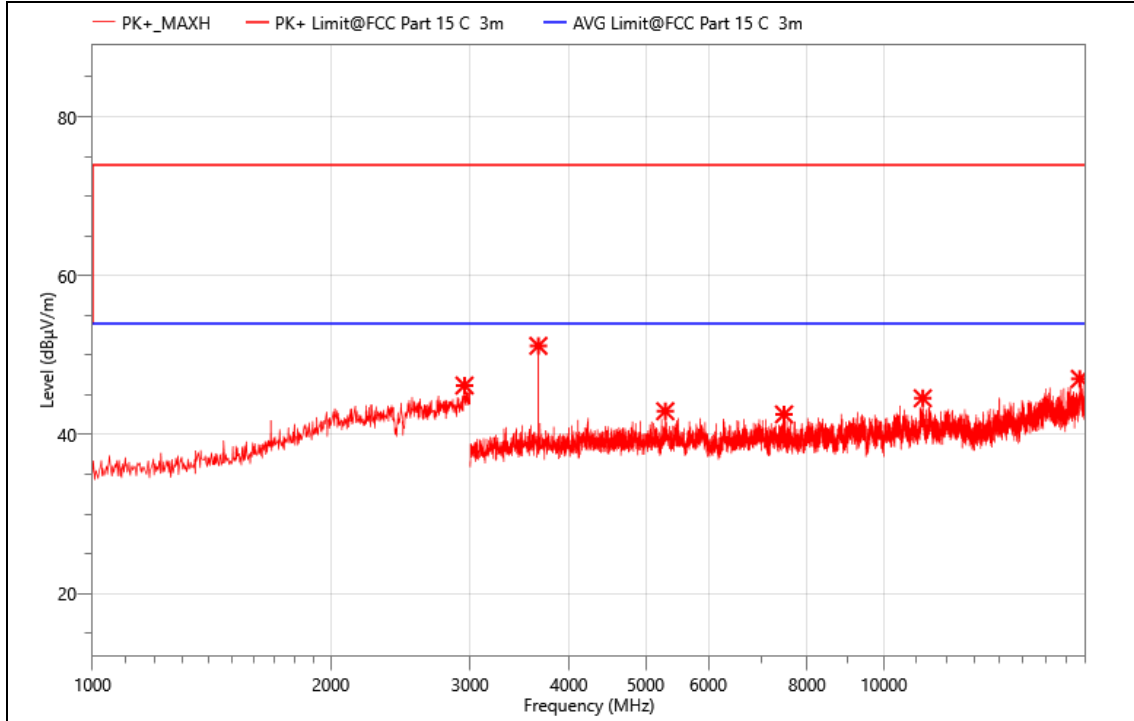

### Critical\_Freqs

No.	Freq. (MHz)	Reading (dBµV)	Meas. (dBµV/m)	Limit (dBµV/m)	Margin (dBµV/m)	Det.	Pol.	Corr. (dB)
1	2952.000	53.60	46.18	74.00	27.82	PK+	V	-7.42
2	3660.000	64.94	51.17	74.00	22.83	PK+	V	-13.77
3	5295.000	52.34	42.95	74.00	31.05	PK+	V	-9.39
4	7480.500	50.50	42.55	74.00	31.45	PK+	V	-7.95
5	11200.500	48.55	44.58	74.00	29.42	PK+	V	-3.97
6	17692.500	47.12	47.02	74.00	26.98	PK+	V	-0.1

Mode:	BLE 2440
Power:	AC120/60Hz
TE:	Big
Date	2023/11/27
T/A/P	24.3°C/54%/101Kpa

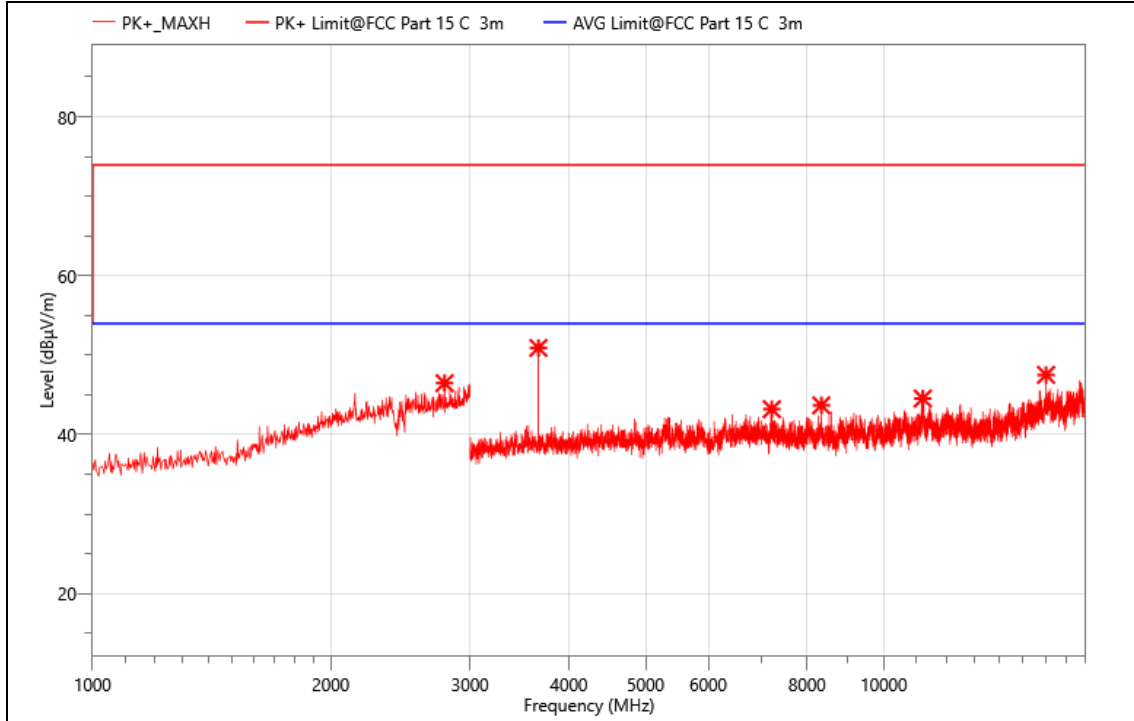

**Critical\_Freqs**

No.	Freq. (MHz)	Reading (dBµV)	Meas. (dBµV/m)	Limit (dBµV/m)	Margin (dBµV/m)	Det.	Pol.	Corr. (dB)
1	2786.000	54.91	46.48	74.00	27.52	PK+	H	-8.43
2	3660.000	64.68	50.91	74.00	23.09	PK+	H	-13.77
3	7219.500	50.89	43.20	74.00	30.80	PK+	H	-7.69
4	8338.500	51.33	43.69	74.00	30.31	PK+	H	-7.64
5	11202.000	48.44	44.54	74.00	29.46	PK+	H	-3.9
6	16036.500	49.11	47.52	74.00	26.48	PK+	H	-1.59

Mode:	BLE 2480
Power:	AC120/60Hz
TE:	Big
Date	2023/11/27
T/A/P	24.3°C/54%/101Kpa

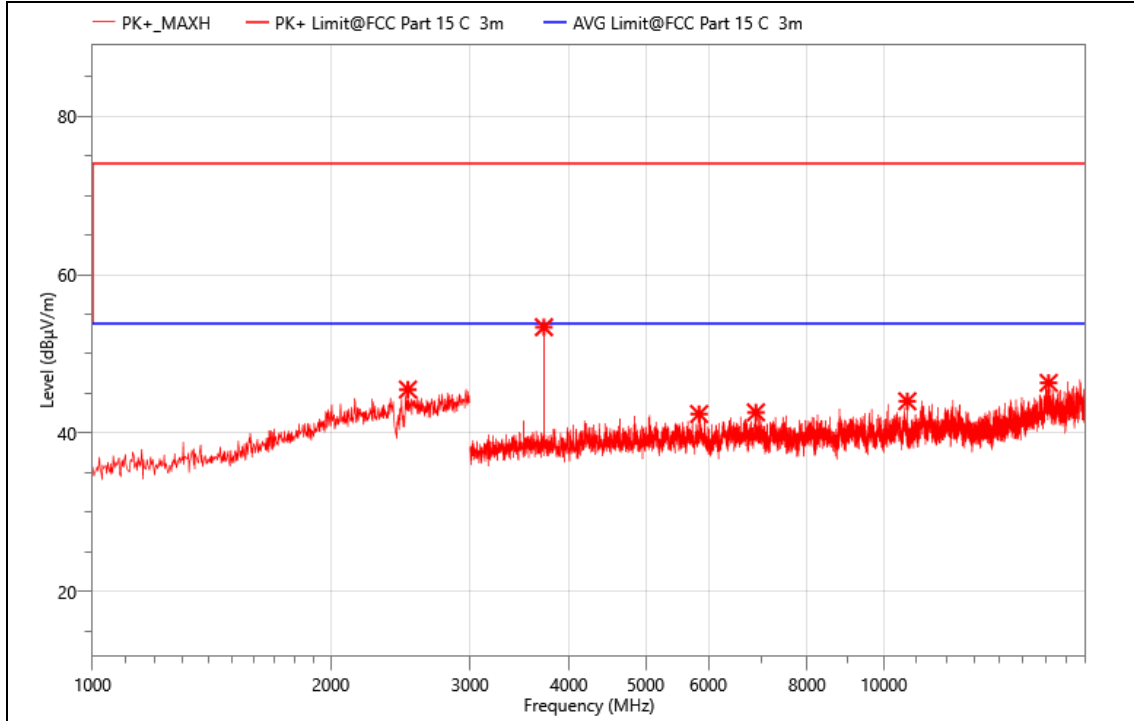

**Critical\_Freqs**

No.	Freq. (MHz)	Reading (dBµV)	Meas. (dBµV/m)	Limit (dBµV/m)	Margin (dBµV/m)	Det.	Pol.	Corr. (dB)
1	2504.000	53.91	45.50	74.00	28.50	PK+	H	-8.41
2	3720.000	67.20	53.37	74.00	20.63	PK+	H	-13.83
3	5842.500	51.17	42.40	74.00	31.60	PK+	H	-8.77
4	6892.500	50.83	42.61	74.00	31.39	PK+	H	-8.22
5	10710.000	49.01	44.01	74.00	29.99	PK+	H	-5
6	16158.000	46.53	46.34	74.00	27.66	PK+	H	-0.19



Mode:	BLE 2480
Power:	AC120/60Hz
TE:	Big
Date	2023/11/27
T/A/P	24.3°C/54%/101Kpa

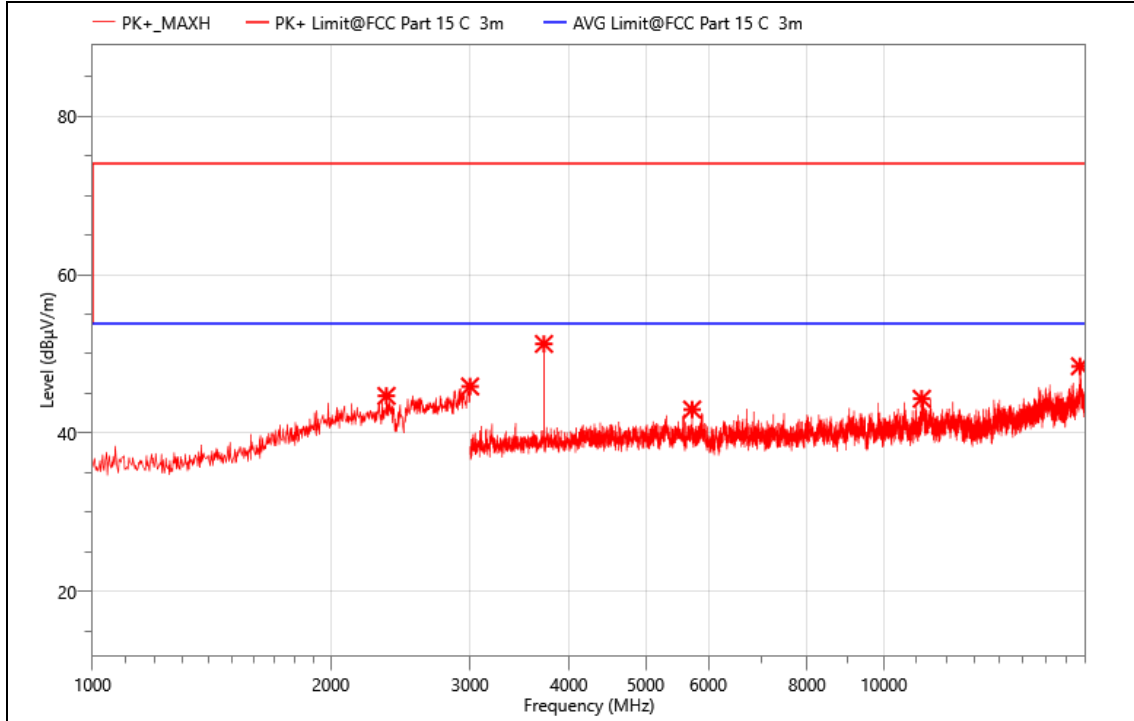

**Critical\_Freqs**

No.	Freq. (MHz)	Reading (dBµV)	Meas. (dBµV/m)	Limit (dBµV/m)	Margin (dBµV/m)	Det.	Pol.	Corr. (dB)
1	2352.000	53.09	44.69	74.00	29.31	PK+	V	-8.4
2	3000.000	52.89	45.88	74.00	28.12	PK+	V	-7.01
3	3720.000	65.09	51.26	74.00	22.74	PK+	V	-13.83
4	5725.500	51.72	42.97	74.00	31.03	PK+	V	-8.75
5	11169.000	48.33	44.33	74.00	29.67	PK+	V	-4
6	17697.000	48.45	48.43	74.00	25.57	PK+	V	-0.02

Note: 1. All the modes had been tested, but only the worst data was recorded in the report.  
 2. For the radiation test from 18 GHz to 26 GHz, a pre-scan was performed, and the result was 20 dB lower than the limit line, the test data was not shown in the report.

● Band Edge

The worst result as bellow:

Mode:	BLE 2402
Power:	AC120/60Hz
TE:	Big
Date	2023/11/27
T/A/P	24.3°C/54%/101Kpa

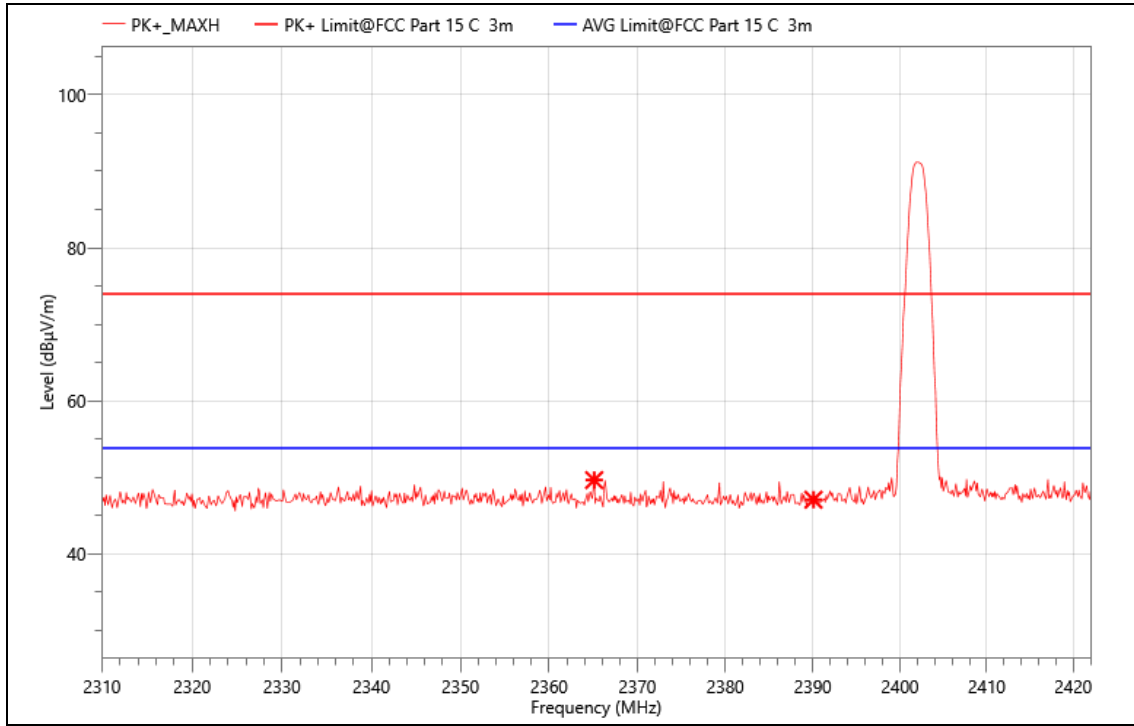

**Critical\_Freqs**

No.	Freq. (MHz)	Reading (dBµV)	Meas. (dBµV/m)	Limit (dBµV/m)	Margin (dBµV/m)	Det.	Pol.	Corr. (dB)
1	2365.104	27.00	49.67	74.00	24.33	PK+	V	22.67
2	2390.080	24.38	47.10	74.00	26.90	PK+	V	22.72

Mode:	BLE 2402
Power:	AC120/60Hz
TE:	Big
Date	2023/11/27
T/A/P	24.3°C/54%/101Kpa

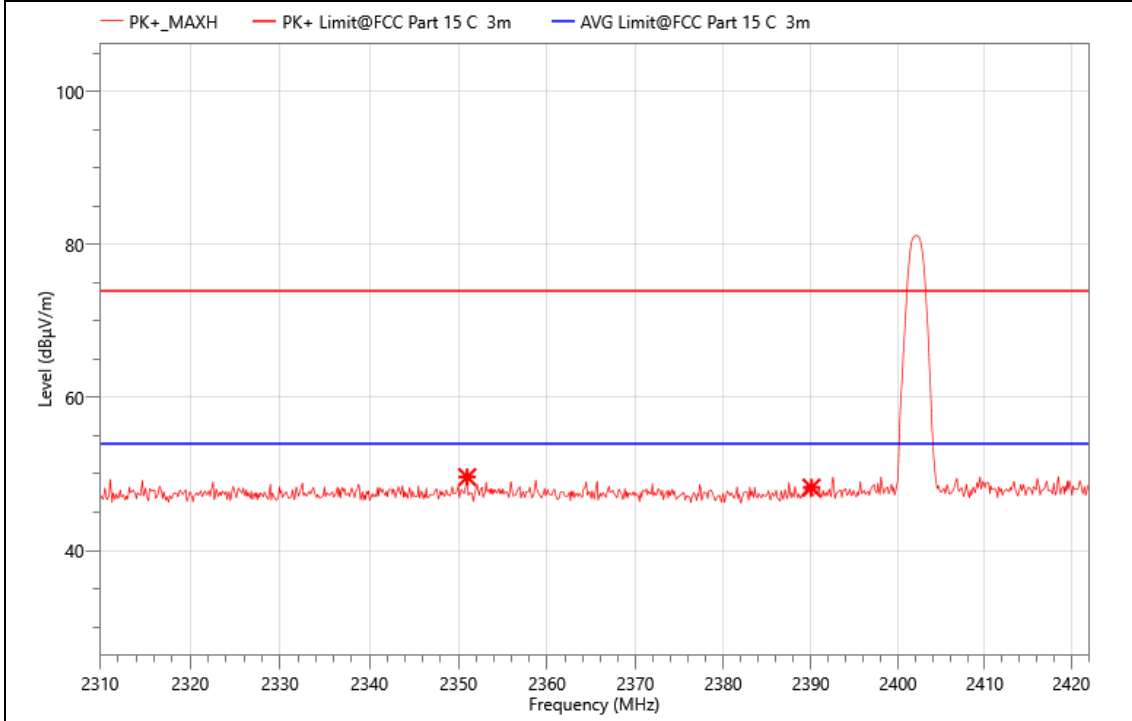

**Critical\_Freqs**

No.	Freq. (MHz)	Reading (dBµV)	Meas. (dBµV/m)	Limit (dBµV/m)	Margin (dBµV/m)	Det.	Pol.	Corr. (dB)
1	2350.992	26.86	49.60	74.00	24.40	PK+	H	22.74
2	2390.080	25.50	48.22	74.00	25.78	PK+	H	22.72

Mode:	BLE 2480
Power:	AC120/60Hz
TE:	Big
Date	2023/11/27
T/A/P	24.3°C/54%/101Kpa

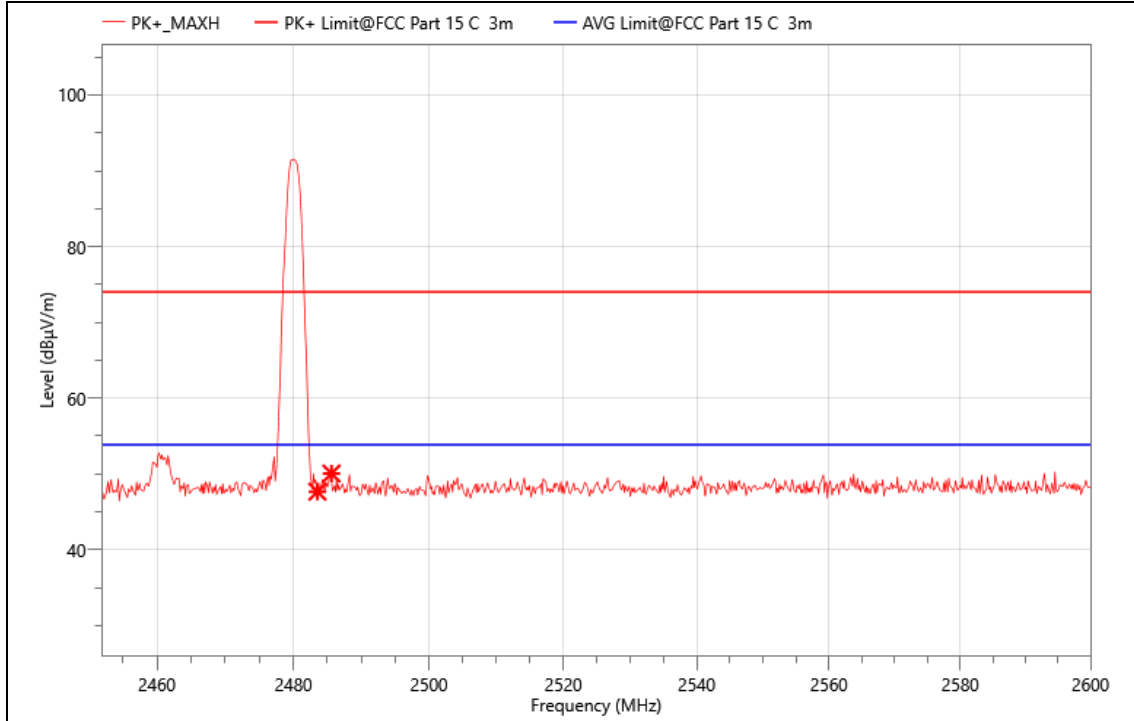

**Critical\_Freqs**

No.	Freq. (MHz)	Reading (dBµV)	Meas. (dBµV/m)	Limit (dBµV/m)	Margin (dBµV/m)	Det.	Pol.	Corr. (dB)
1	2483.524	24.50	47.65	74.00	26.35	PK+	V	23.15
2	2485.596	26.91	50.05	74.00	23.95	PK+	V	23.14

Mode:	BLE 2480
Power:	AC120/60Hz
TE:	Big
Date	2023/11/27
T/A/P	24.3°C/54%/101Kpa

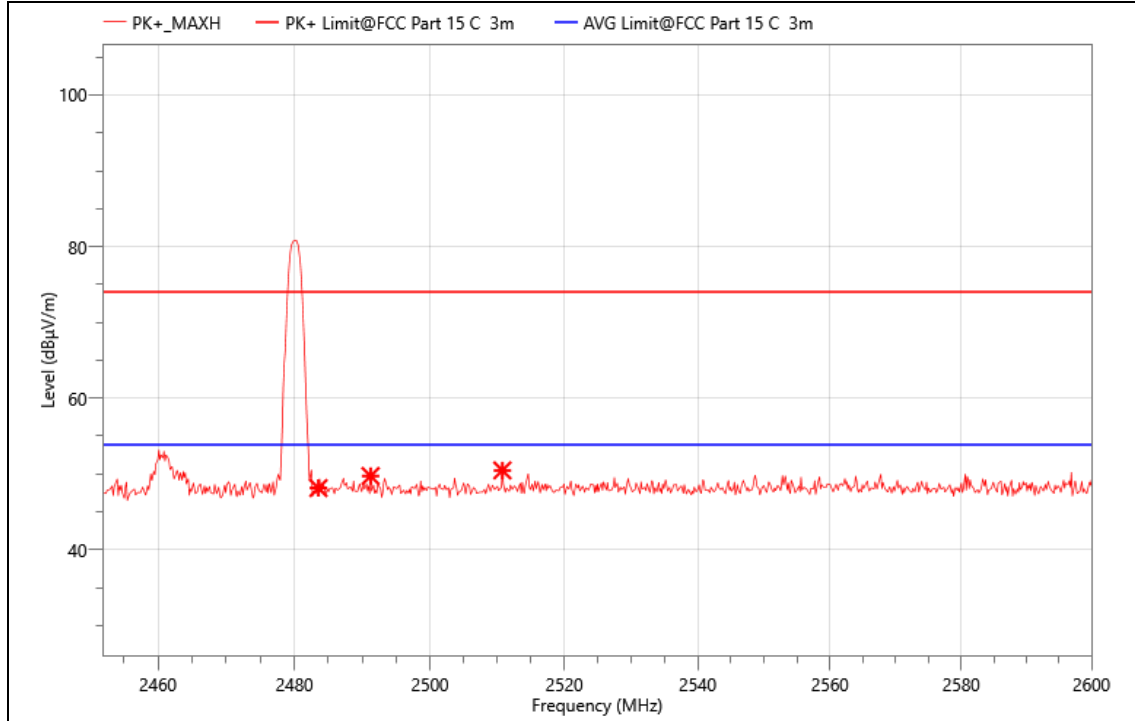

**Critical\_Freqs**

No.	Freq. (MHz)	Reading (dBµV)	Meas. (dBµV/m)	Limit (dBµV/m)	Margin (dBµV/m)	Det.	Pol.	Corr. (dB)
1	2483.524	24.98	48.13	74.00	25.87	PK+	H	23.15
2	2491.220	26.59	49.72	74.00	24.28	PK+	H	23.13
3	2510.756	27.35	50.46	74.00	23.54	PK+	H	23.11

Note:

1. Measurement = Reading Level + Correct Factor.
2. If Peak Result complies with AV limit, AV Result is deemed to comply with AV limit.
3. Peak: Peak detector.
4. Only the worst data was recorded, if it complies with the limit, the other emissions deemed to comply with the limit.

## **9. ANTENNA REQUIREMENT**

### **REQUIREMENT**

Please refer to FCC §15.203

An intentional radiator shall be designed to ensure that no antenna other than that furnished by the responsible party shall be used with the device. The use of a permanently attached antenna or of an antenna that uses a unique coupling to the intentional radiator shall be considered sufficient to comply with the provisions of this section. The manufacturer may design the unit so that a broken antenna can be replaced by the user, but the use of a standard antenna jack or electrical connector is prohibited.

Please refer to FCC §15.247(b)(4), RSS-GEN Clause 6.8

The conducted output power limit specified in paragraph (b) of this section is based on the use of antennas with directional gains that do not exceed 6 dBi. Except as shown in paragraph (c) of this section, if transmitting antennas of directional gain greater than 6 dBi are used, the conducted output power from the intentional radiator shall be reduced below the stated values in paragraphs (b)(1), (b)(2), and (b)(3) of this section, as appropriate, by the amount in dB that the directional gain of the antenna exceeds 6 dBi.

### **DESCRIPTION**

Compliance

## 10. AC POWER LINE CONDUCTED EMISSION

### LIMITS

Please refer to CFR 47 FCC §15.207 (a) and ISED RSS-Gen Clause 8.8

FREQUENCY (MHz)	Quasi-peak	Average
0.15 -0.5	66 - 56 *	56 - 46 *
0.50 -5.0	56.00	46.00
5.0 -30.0	60.00	50.00

### TEST PROCEDURE

The EUT is put on a table of non-conducting material that is 80 cm high. The vertical conducting wall of shielding is located 40 cm to the rear of the EUT. The power line of the EUT is connected to the AC mains through a Artificial Mains Network (A.M.N.). A EMI Measurement Receiver (R&S Test Receiver ESR3) is used to test the emissions from both sides of AC line. According to the requirements in Section 6.2 of ANSI C63.10-2013. Conducted emissions from the EUT measured in the frequency range between 0.15 MHz and 30 MHz using CISPR Quasi-Peak and average detector mode. The bandwidth of EMI test receiver is set at 9 kHz.

The arrangement of the equipment is installed to meet the standards and operating in a manner, which tends to maximize its emission characteristics in a normal application.

### TEST SETUP

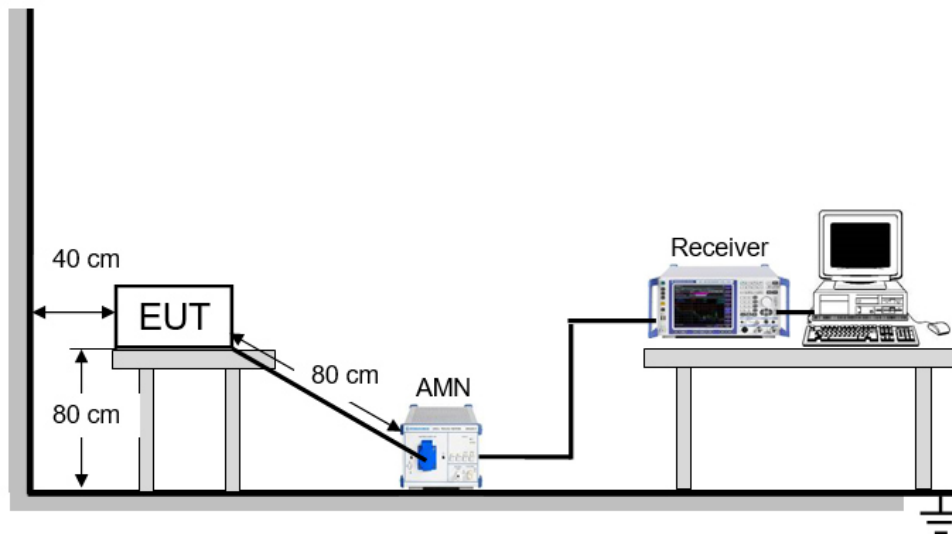

### TEST ENVIRONMENT

Temperature	24.3°C	Relative Humidity	52%
Atmosphere Pressure	101kPa		

**TEST RESULTS**

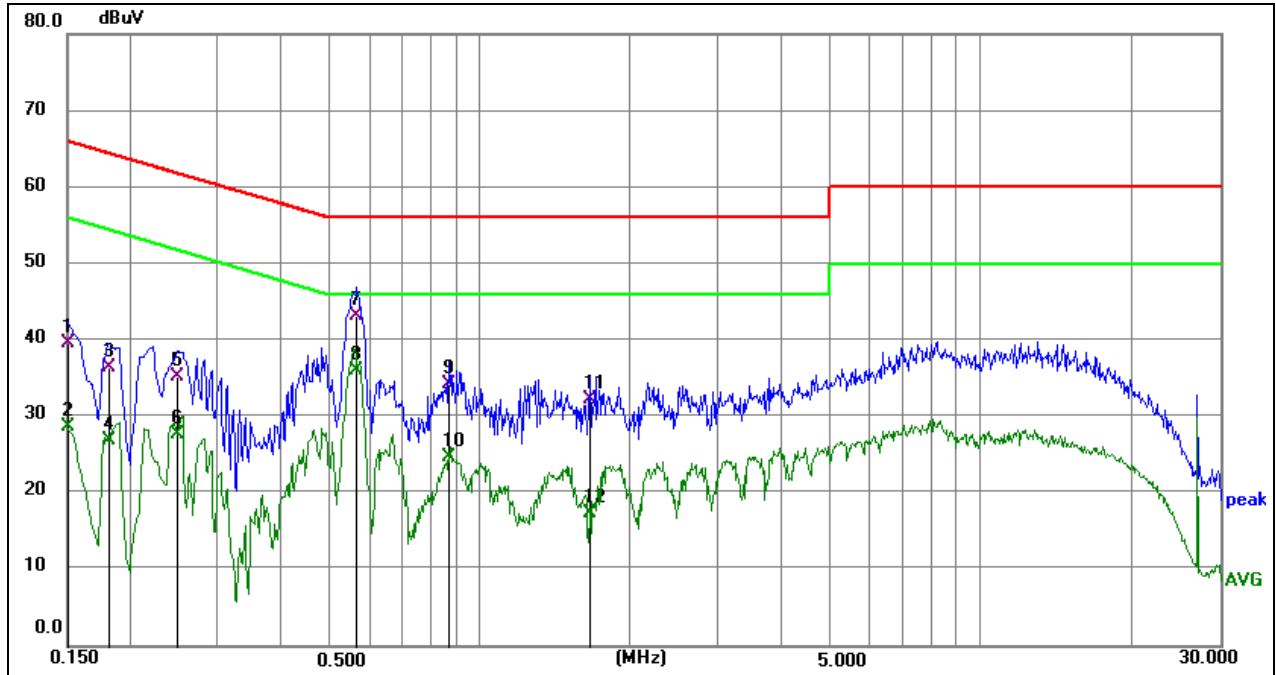

Phase: N	Mode: BLE 2402MHz
----------	-------------------

No.	Frequency (MHz)	Reading (dBuV)	Correct (dB)	Result (dBuV)	Limit (dBuV)	Margin (dB)	Remark
1	0.1500	29.52	10.00	39.52	66.00	-26.48	QP
2	0.1500	18.65	10.00	28.65	56.00	-27.35	AVG
3	0.1814	26.58	9.94	36.52	64.42	-27.90	QP
4	0.1814	16.98	9.94	26.92	54.42	-27.50	AVG
5	0.2490	25.24	9.91	35.15	61.79	-26.64	QP
6	0.2490	17.85	9.91	27.76	51.79	-24.03	AVG
7	0.5685	33.27	9.99	43.26	56.00	-12.74	QP
8	0.5685	26.05	9.99	36.04	46.00	-9.96	AVG
9	0.8700	24.22	10.04	34.26	56.00	-21.74	QP
10	0.8700	14.68	10.04	24.72	46.00	-21.28	AVG
11	1.6620	21.99	10.17	32.16	56.00	-23.84	QP
12	1.6620	7.15	10.17	17.32	46.00	-28.68	AVG



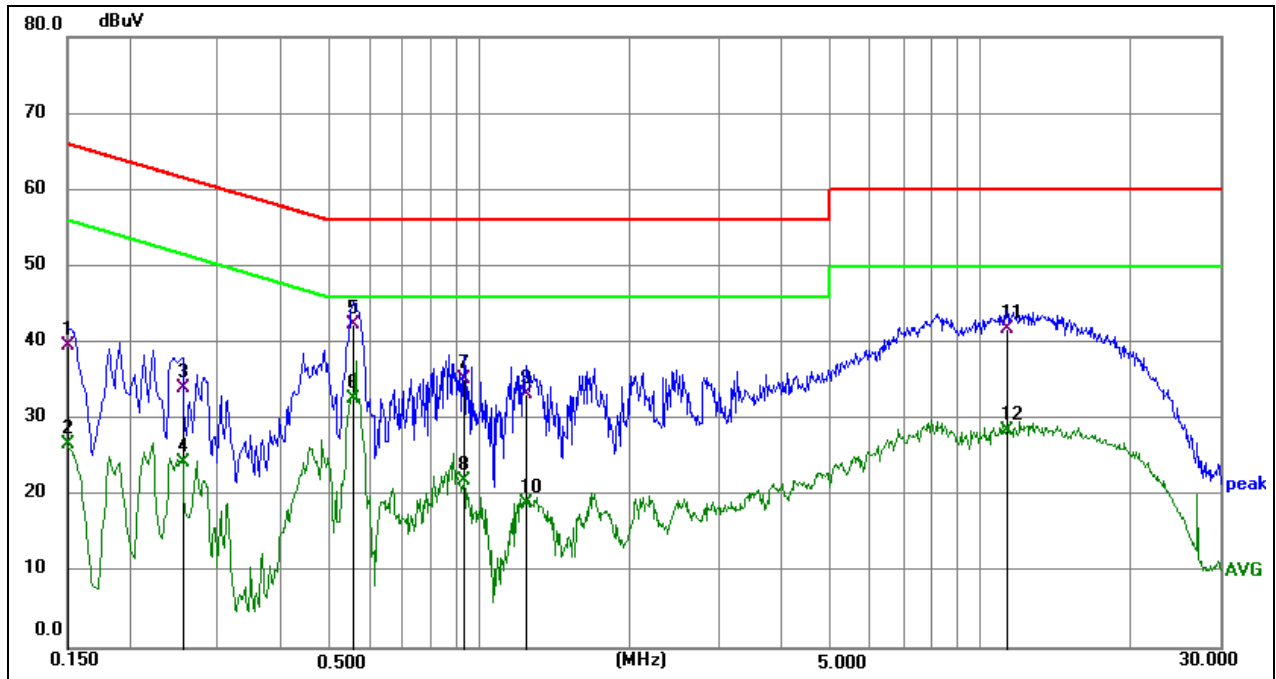

Phase: L1	Mode: BLE 2402MHz
-----------	-------------------

No.	Frequency (MHz)	Reading (dBuV)	Correct (dB)	Result (dBuV)	Limit (dBuV)	Margin (dB)	Remark
1	0.1500	29.62	9.90	39.52	66.00	-26.48	QP
2	0.1500	16.80	9.90	26.70	56.00	-29.30	AVG
3	0.2535	24.32	9.80	34.12	61.64	-27.52	QP
4	0.2535	14.61	9.80	24.41	51.64	-27.23	AVG
5	0.5594	32.42	9.94	42.36	56.00	-13.64	QP
6	0.5594	22.62	9.94	32.56	46.00	-13.44	AVG
7	0.9284	25.21	10.05	35.26	56.00	-20.74	QP
8	0.9284	11.91	10.05	21.96	46.00	-24.04	AVG
9	1.2390	23.17	10.08	33.25	56.00	-22.75	QP
10	1.2390	8.93	10.08	19.01	46.00	-26.99	AVG
11	11.2964	30.69	11.00	41.69	60.00	-18.31	QP
12	11.2964	17.55	11.00	28.55	50.00	-21.45	AVG

- Note: 1. Result = Reading + Correct Factor.  
 2. If QP Result complies with AV limit, AV Result is deemed to comply with AV limit.  
 3. Test setup: RBW: 200 Hz (9 kHz ~ 150 kHz), 9 kHz (150 kHz ~ 30 MHz).  
 4. Step size: 80 Hz (0.009 MHz ~ 0.15 MHz), 4 kHz (0.15 MHz ~ 30 MHz), Scan time: auto.

Note: All the modes have been tested, only the worst data was recorded in the report.

## 11. TEST DATA - Appendix A

### Duty Cycle

Condition	Mode	Frequency (MHz)	Antenna	On Time (ms)	Period (ms)	Duty Cycle (%)	Correction Factor (dB)	1/T (kHz)	Final settingFor VBW (kHz)
NVNT	BLE 1M	2402	Ant1	0.31	0.93	33.33	4.77	3.25	1
NVNT	BLE 1M	2440	Ant1	0.31	0.93	33.33	4.77	3.25	1
NVNT	BLE 1M	2480	Ant1	0.31	0.93	33.33	4.77	3.26	1

## Maximum Conducted Output Power

Condition	Mode	Frequency (MHz)	Antenna	Conducted Power (dBm)	Duty Factor (dB)	Total Power (dBm)	Limit (dBm)	E.I.R.P (dBm)	E.I.R.P Limit (dBm)	Verdict
NVNT	BLE 1M	2402	Ant1	-0.45	0	-0.45	30	3.05	<=36.02	Pass
NVNT	BLE 1M	2440	Ant1	-0.9	0	-0.9	30	2.60	<=36.02	Pass
NVNT	BLE 1M	2480	Ant1	-0.77	0	-0.77	30	2.73	<=36.02	Pass

Note1: Antenna Gain: 3.50dBi;

Note2: E.I.R.P = Measured Power + Antenna Gain

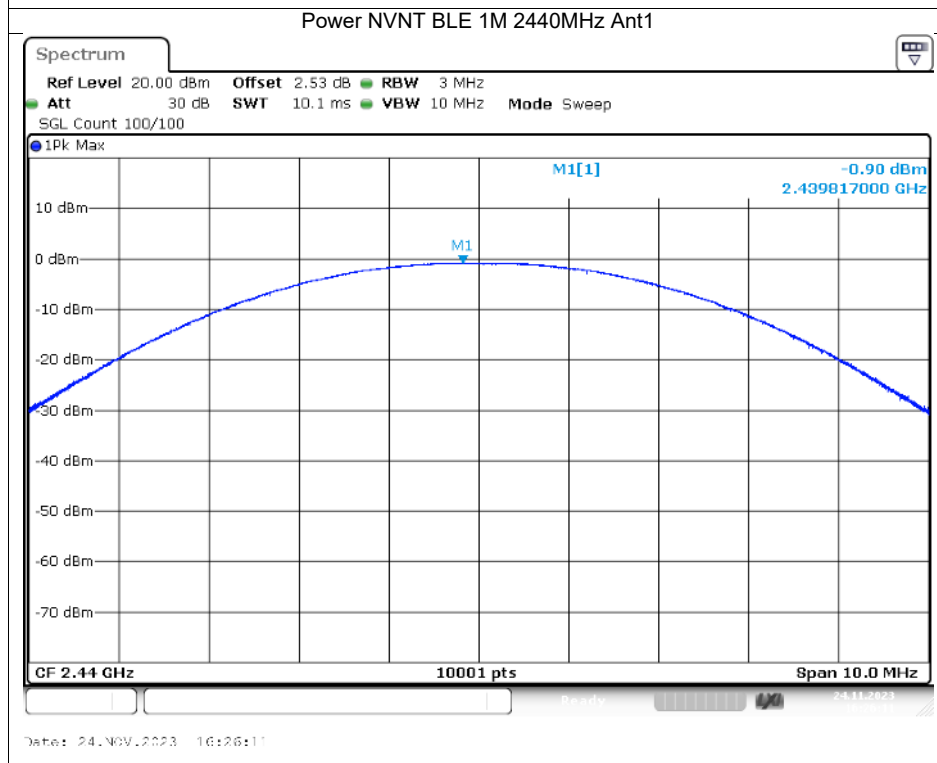
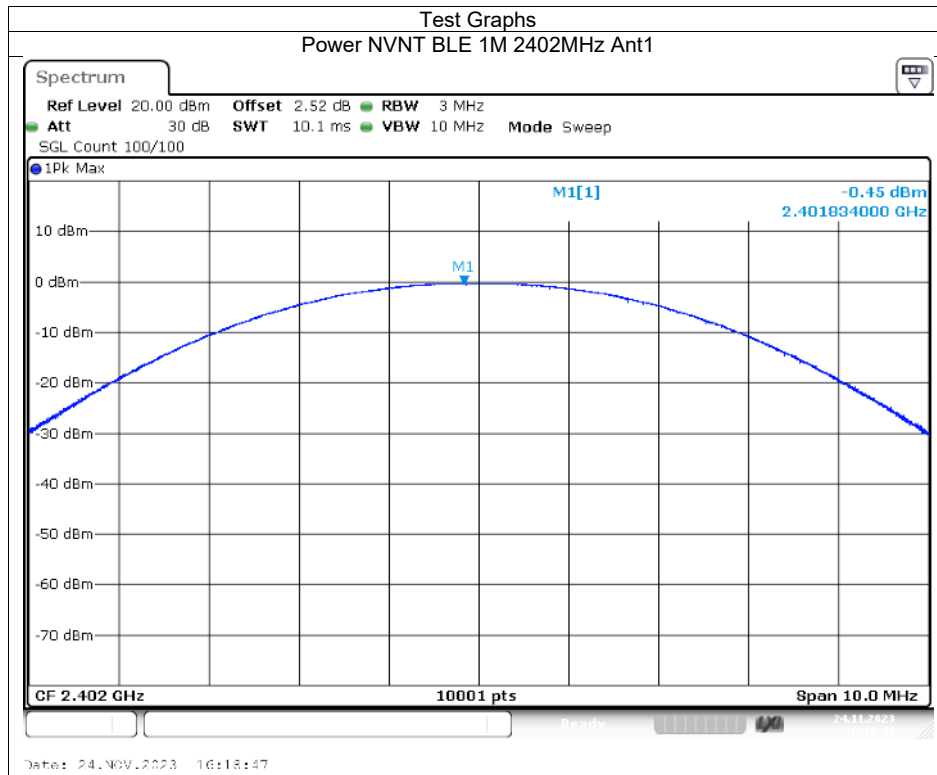

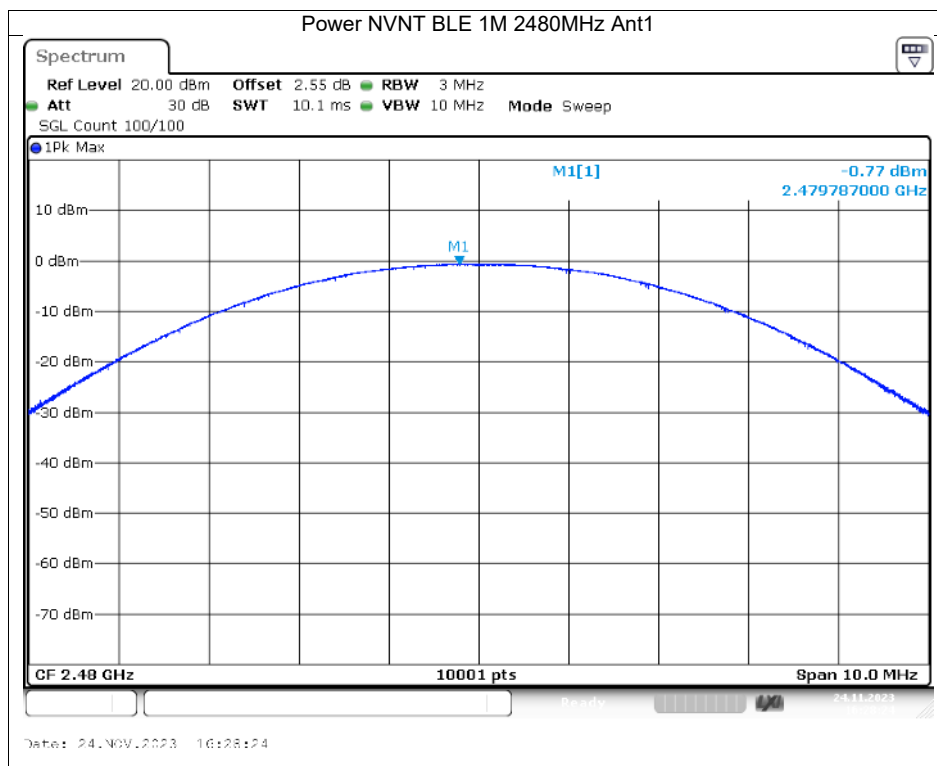

## -6dB Bandwidth

Condition	Mode	Frequency (MHz)	Antenna	-6 dB Bandwidth (MHz)	Limit -6 dB Bandwidth (MHz)	Verdict
NVNT	BLE 1M	2402	Ant1	0.642	0.5	Pass
NVNT	BLE 1M	2440	Ant1	0.66	0.5	Pass
NVNT	BLE 1M	2480	Ant1	0.652	0.5	Pass

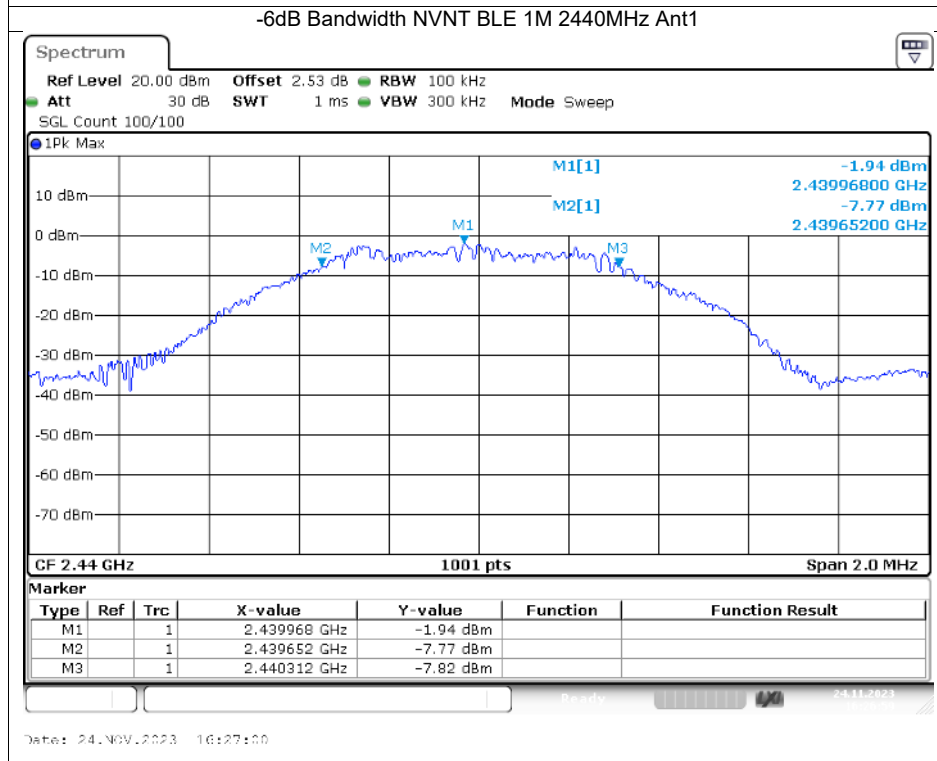
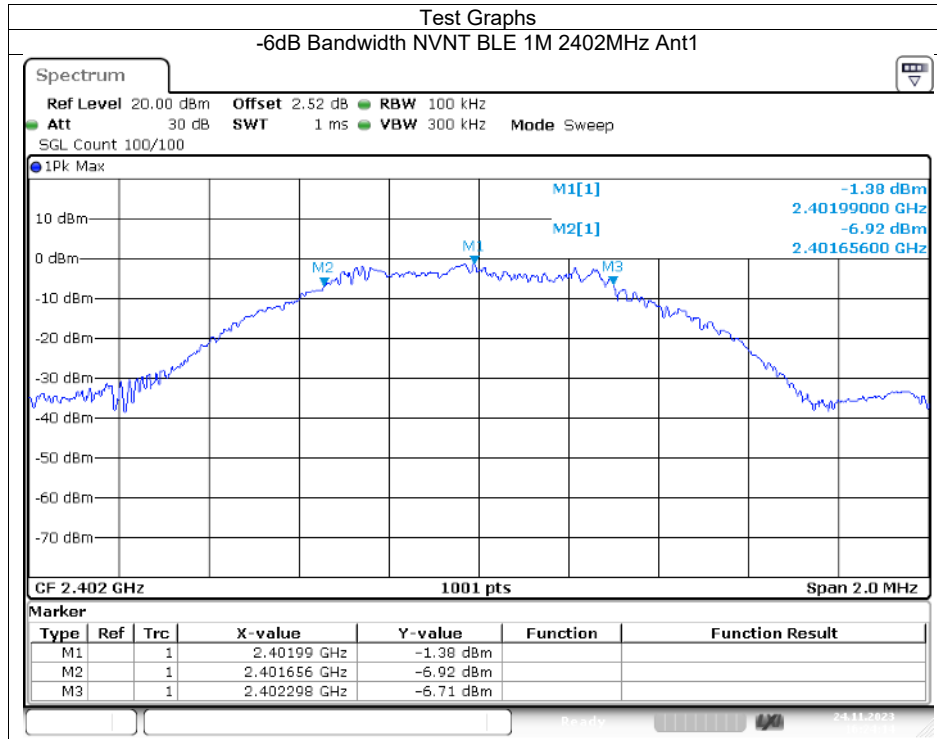

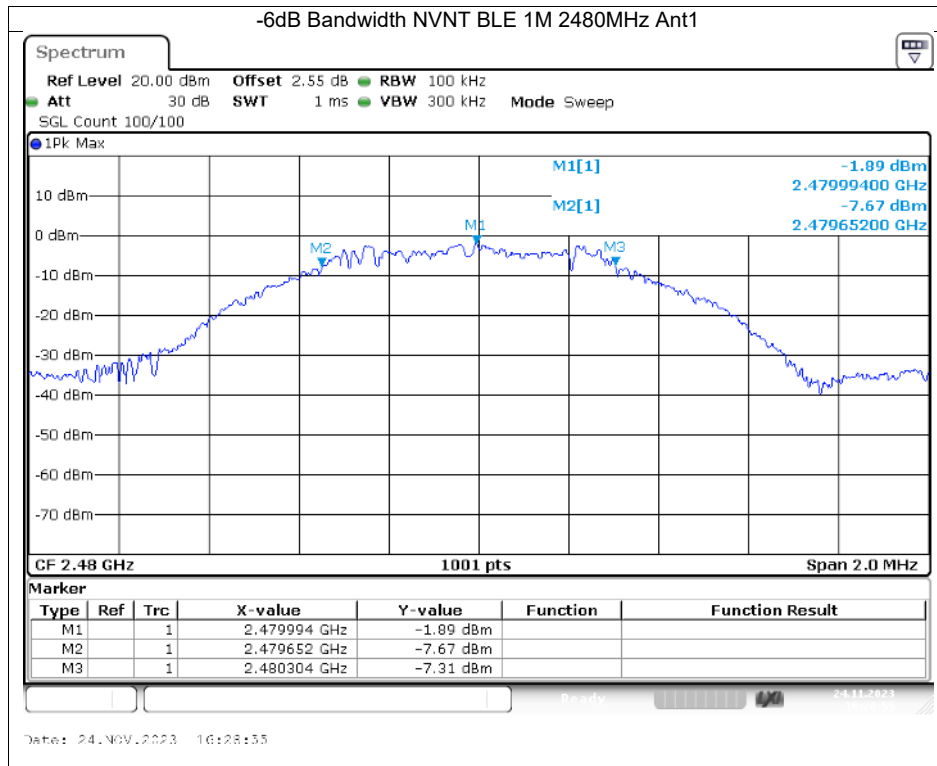



## Occupied Channel Bandwidth

Condition	Mode	Frequency (MHz)	Antenna	99% OBW (MHz)
NVNT	BLE 1M	2402	Ant1	1.031
NVNT	BLE 1M	2440	Ant1	1.019
NVNT	BLE 1M	2480	Ant1	1.019

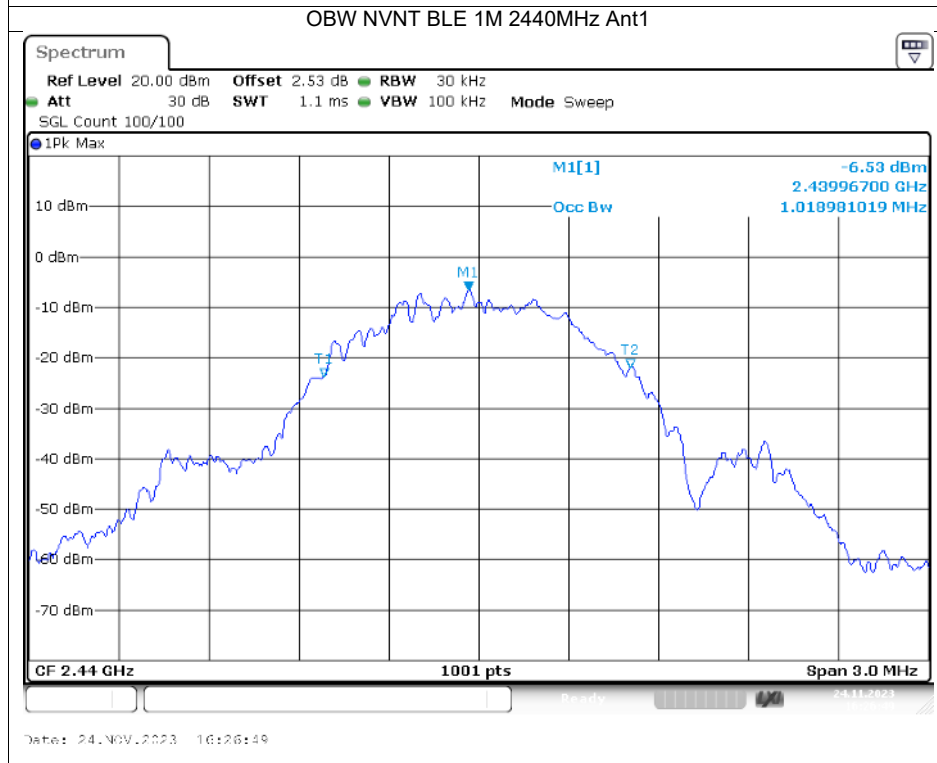
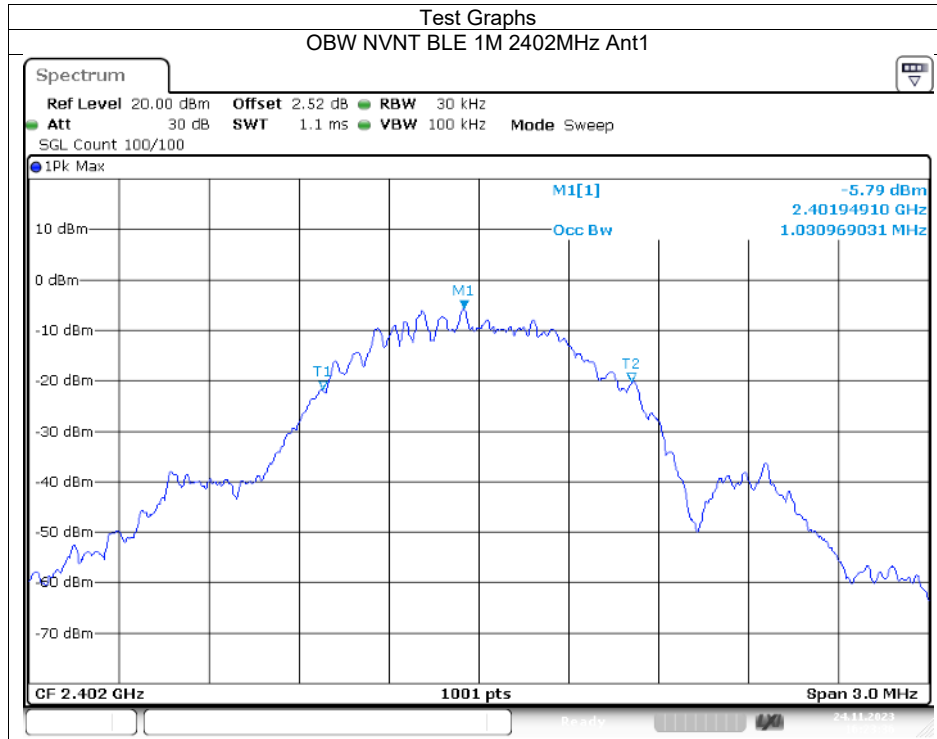

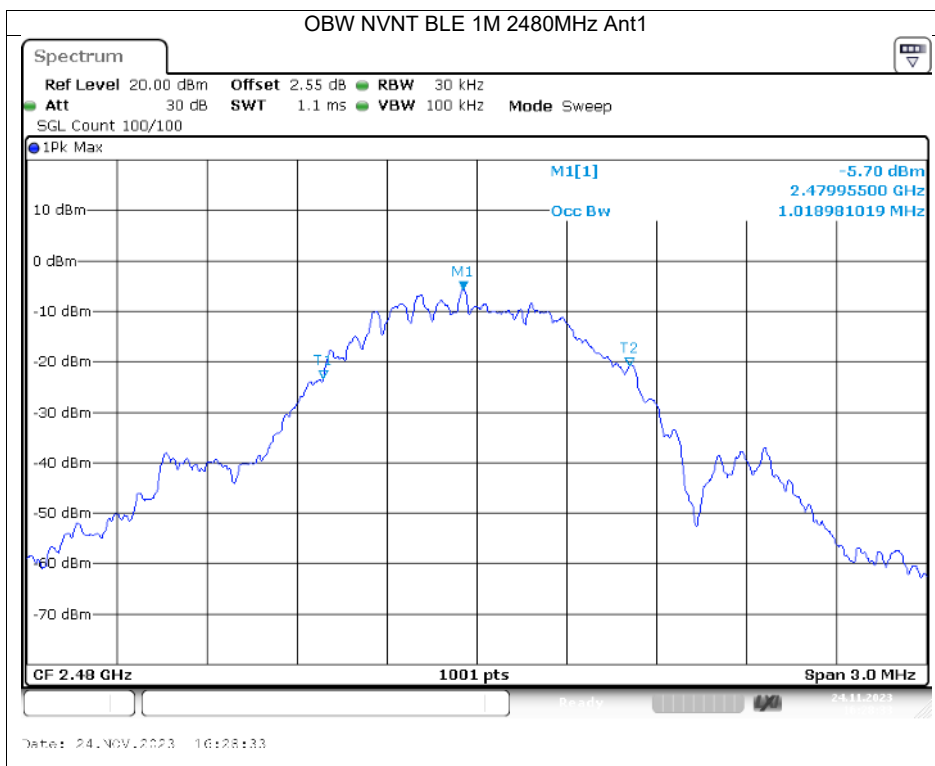

## Maximum Power Spectral Density Level

Condition	Mode	Frequency (MHz)	Antenna	Conducted PSD (dBm/3kHz)	Duty Factor (dB)	Total PSD (dBm/3kHz)	Limit (dBm/3kHz)	Verdict
NVNT	BLE 1M	2402	Ant1	-18.03	0	-18.03	8	Pass
NVNT	BLE 1M	2440	Ant1	-18.55	0	-18.55	8	Pass
NVNT	BLE 1M	2480	Ant1	-18.45	0	-18.45	8	Pass

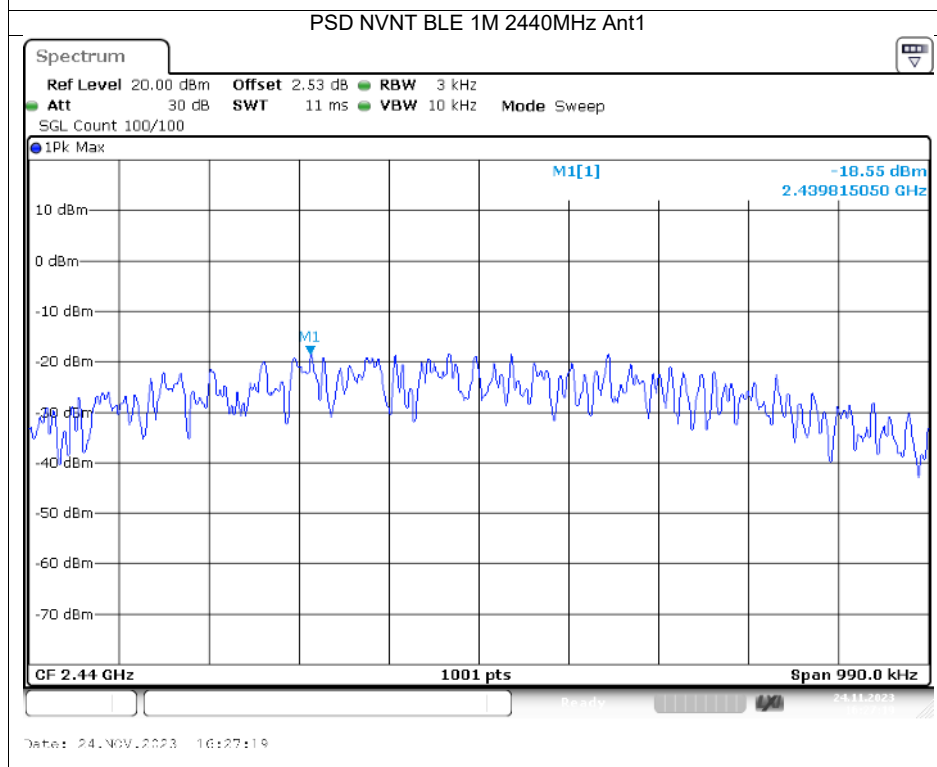
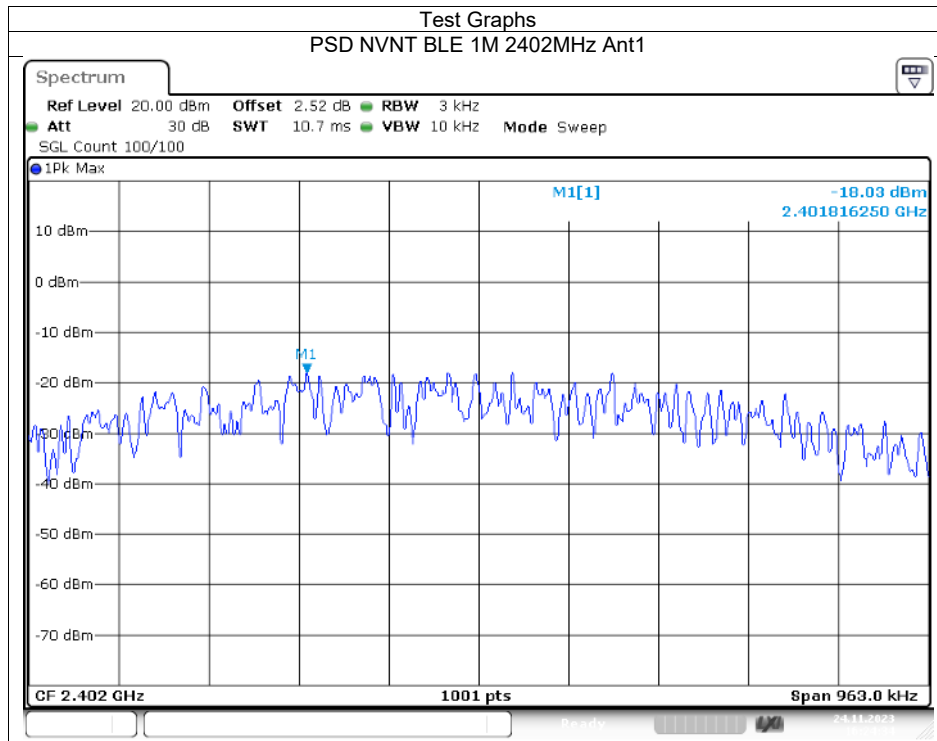

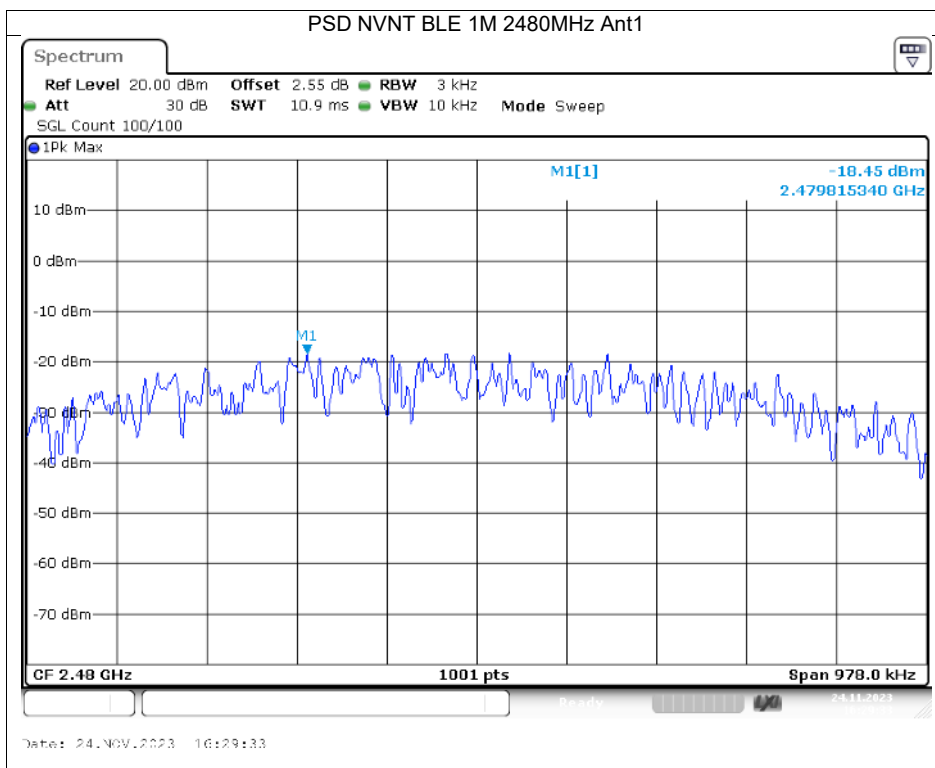

## Band Edge

Condition	Mode	Frequency (MHz)	Antenna	Max Value (dBc)	Limit (dBc)	Verdict
NVNT	BLE 1M	2402	Ant1	-53.14	-20	Pass
NVNT	BLE 1M	2480	Ant1	-53.76	-20	Pass

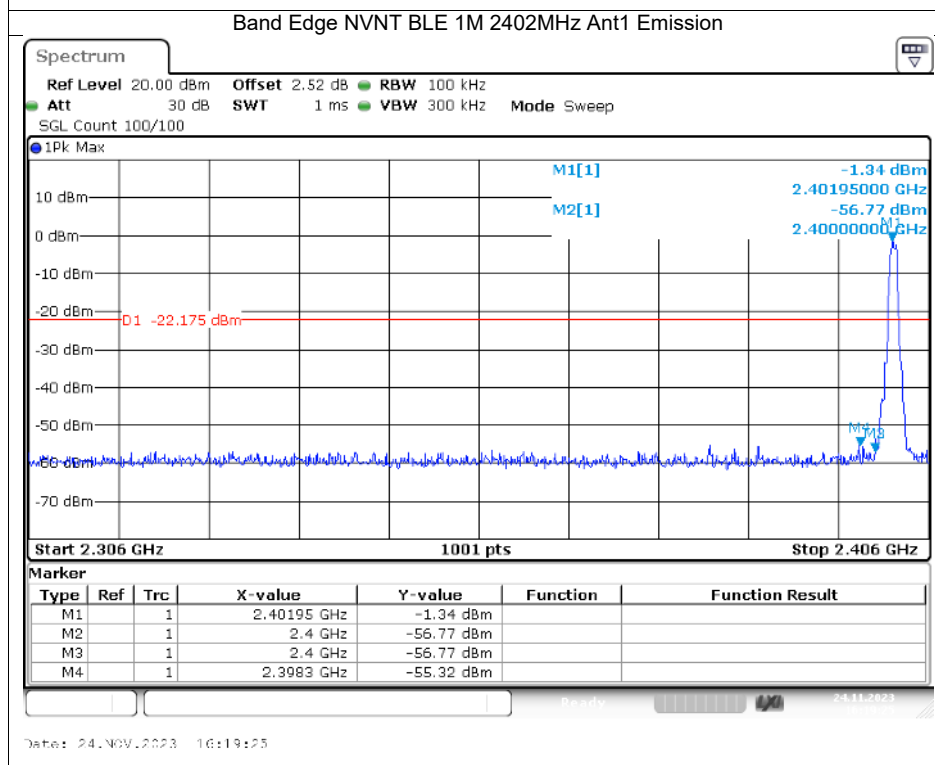
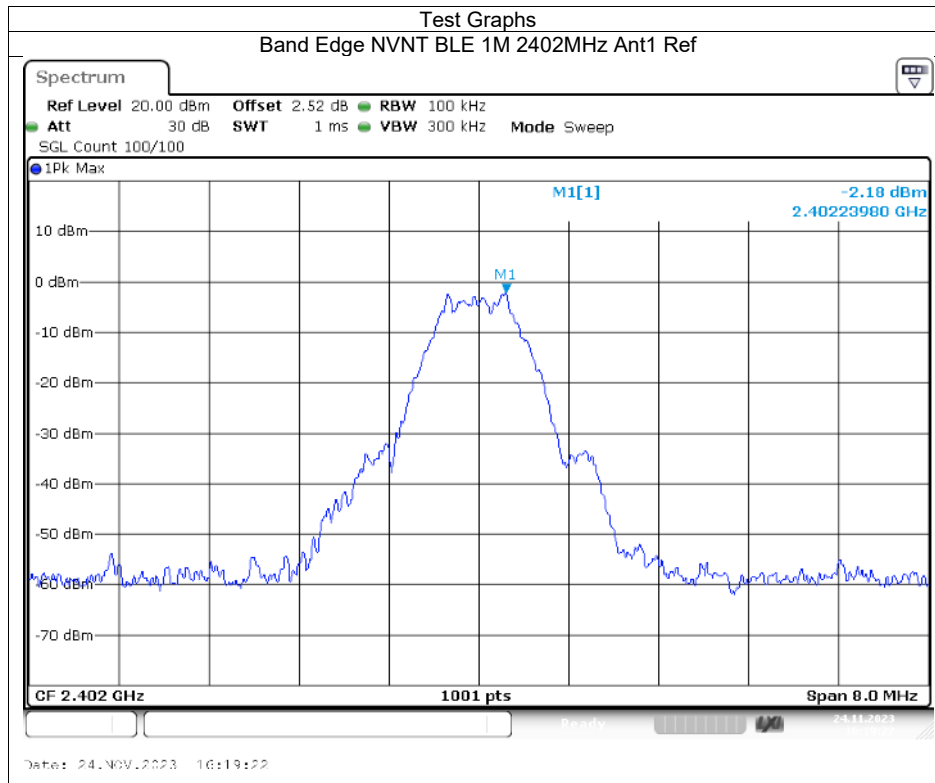



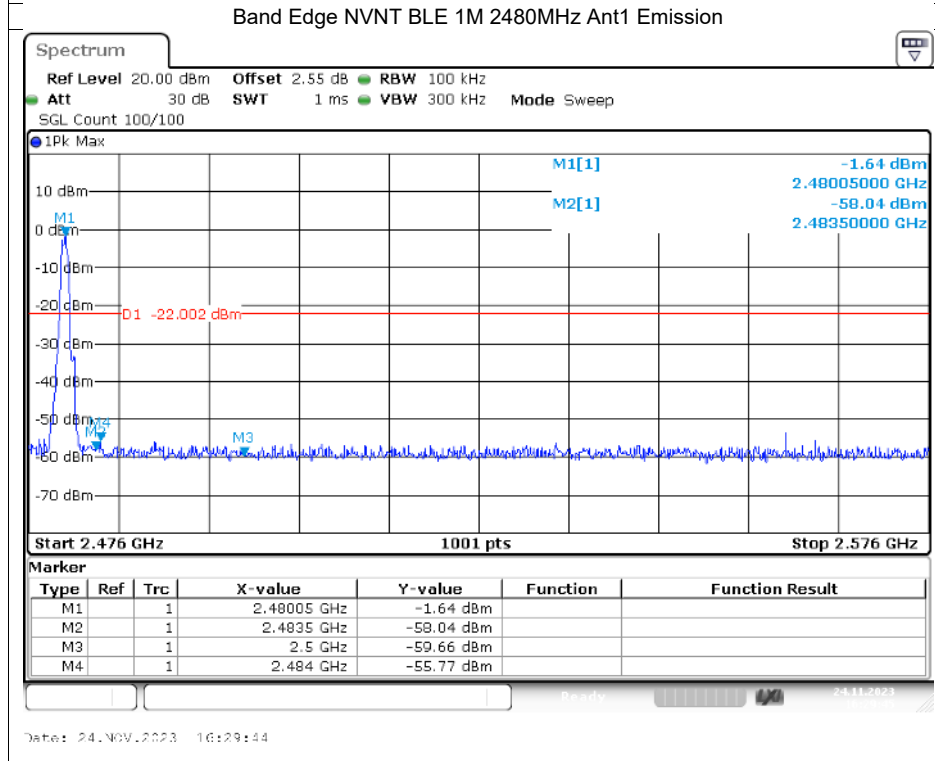
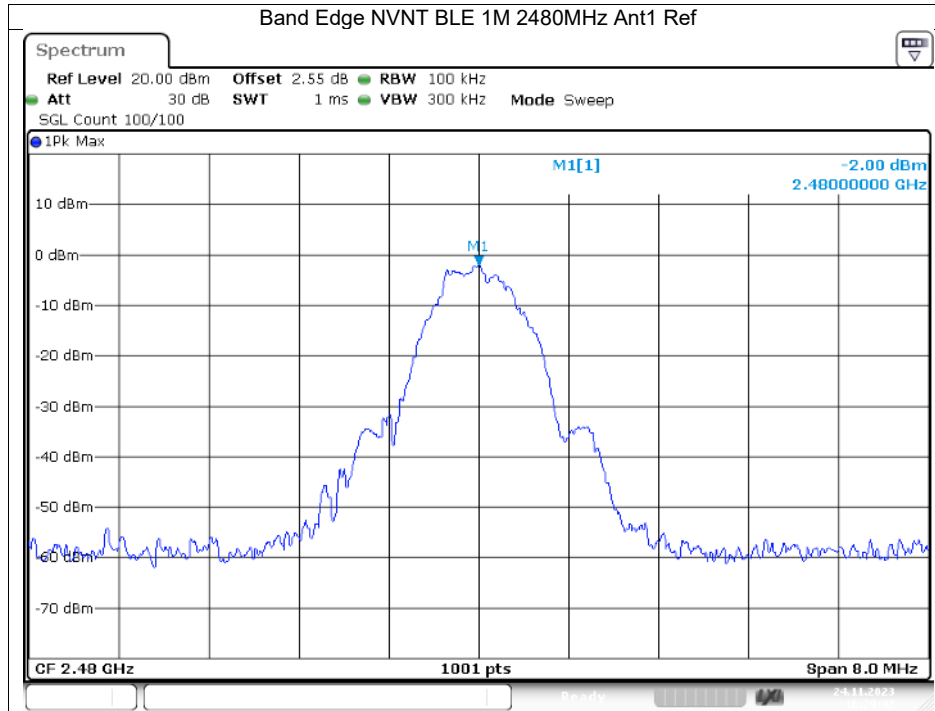

## Conducted RF Spurious Emission

Condition	Mode	Frequency (MHz)	Antenna	Max Value (dBc)	Limit (dBc)	Verdict
NVNT	BLE 1M	2402	Ant1	-37.18	-20	Pass
NVNT	BLE 1M	2440	Ant1	-34.92	-20	Pass
NVNT	BLE 1M	2480	Ant1	-35.85	-20	Pass

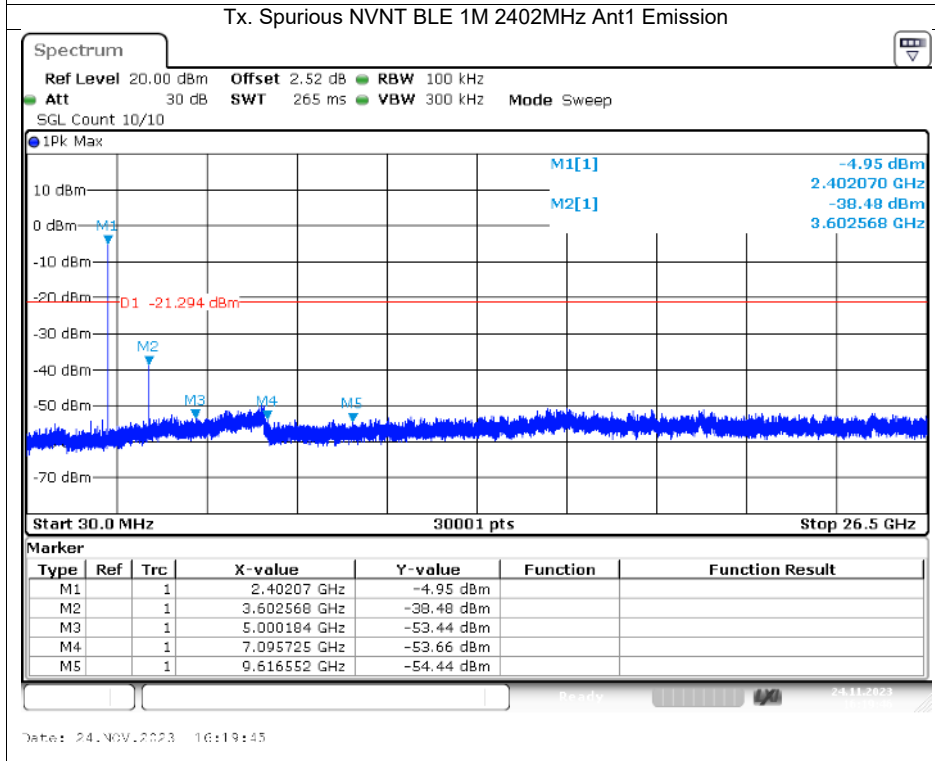
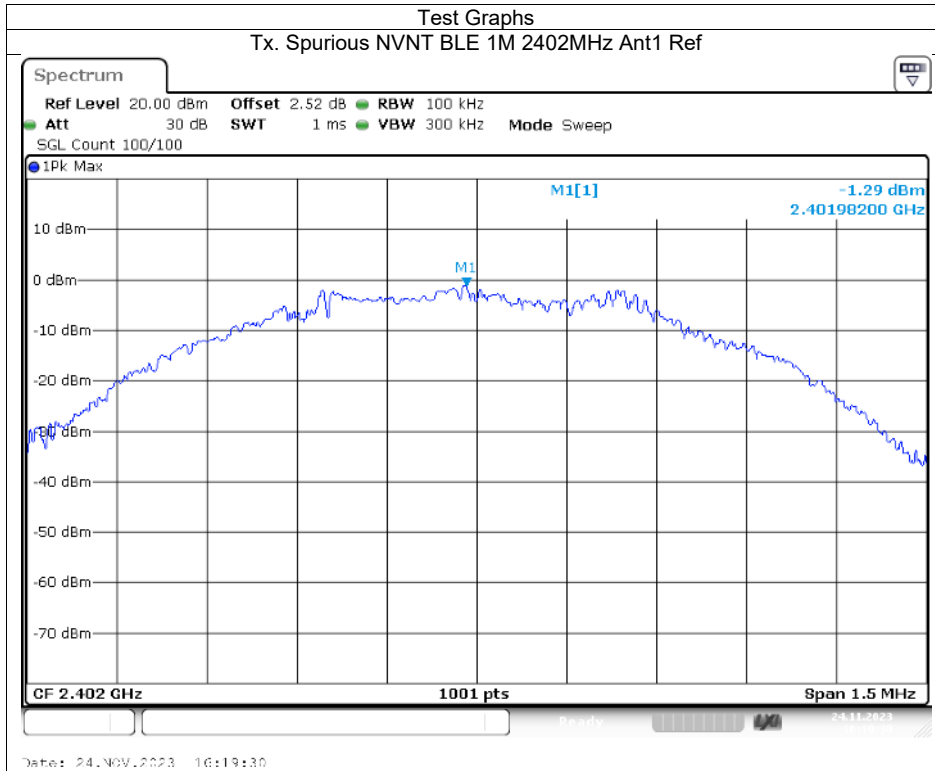

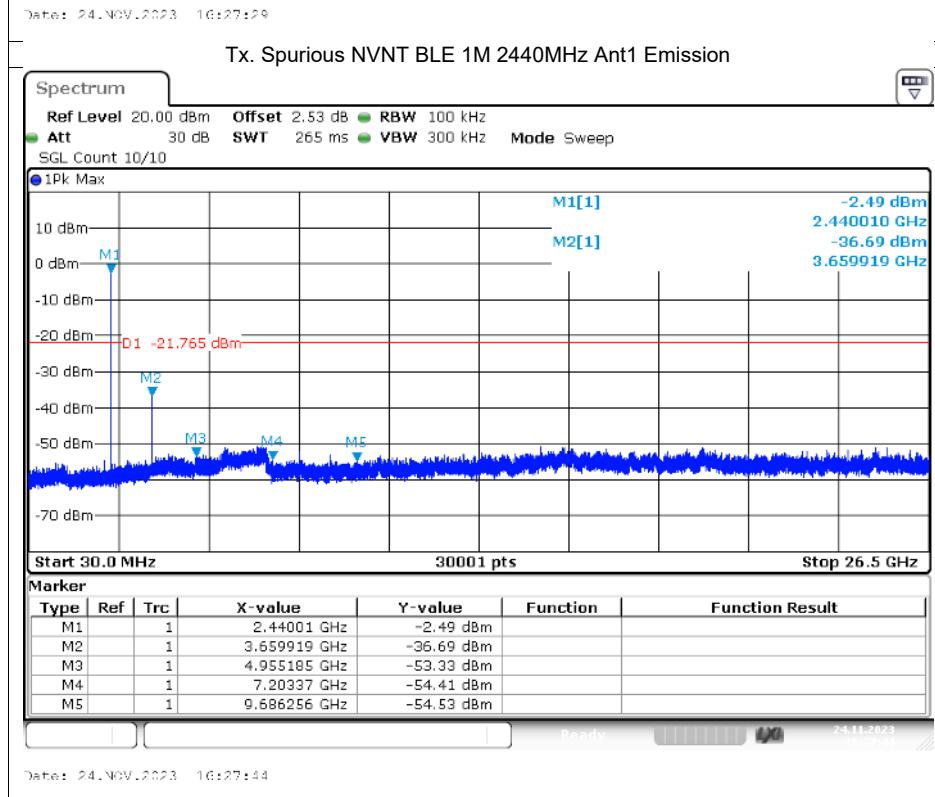
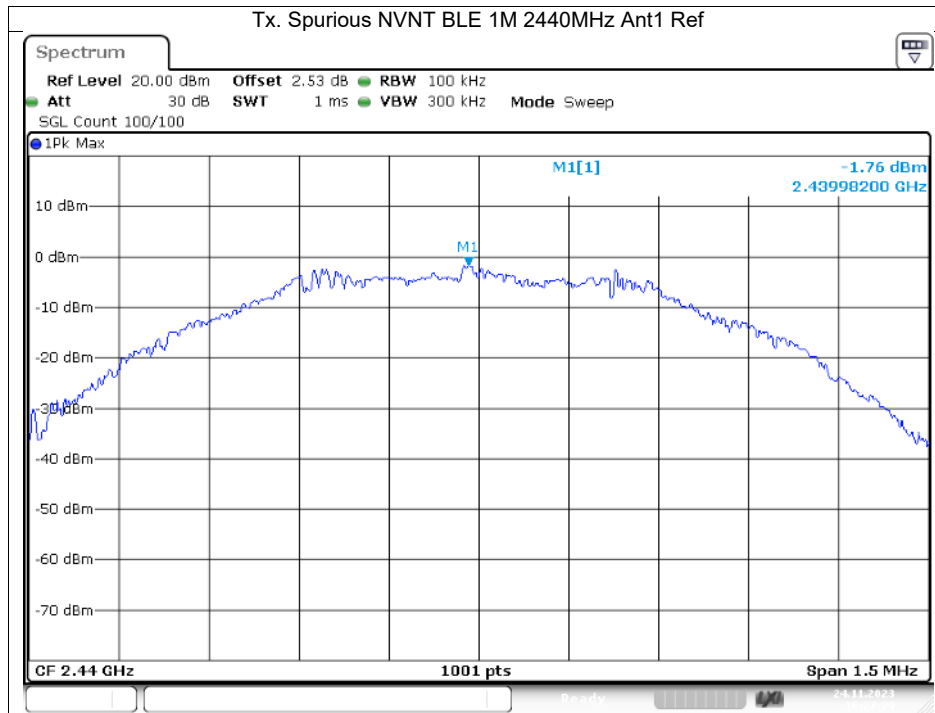

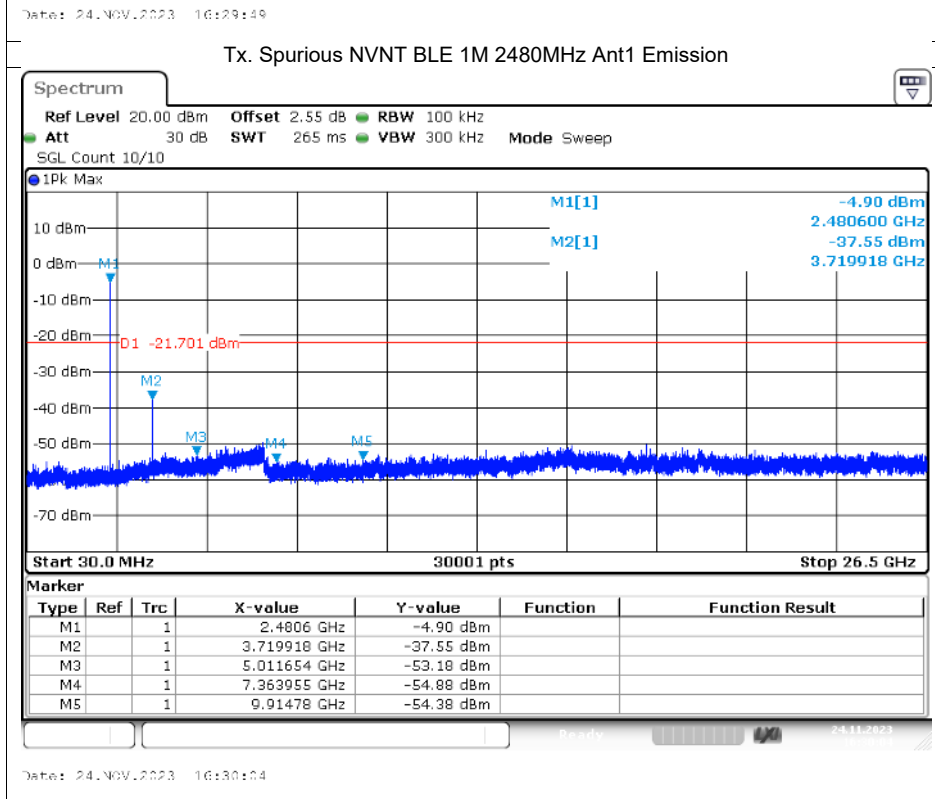
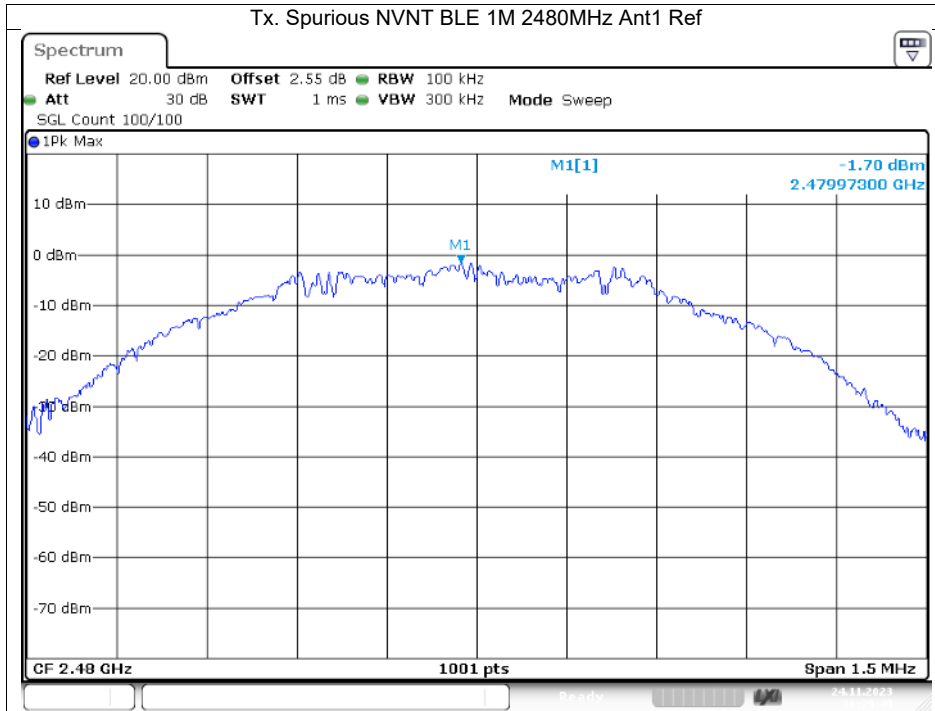

## **APPENDIX: PHOTOGRAPHS OF TEST CONFIGURATION**

Please refer to the report: E04A23110780F00401.

## **APPENDIX: PHOTOGRAPHS OF THE EUT**

Please refer to the report: E04A23110780F00401.

---

**END OF REPORT**