

FCC 47 CFR Part 15.407

TEST REPORT

For

Botslab Outdoor Pan/Tilt Camera Pro

MODEL NUMBER: W312

REPORT NUMBER: E04A23060231F00102

ISSUE DATE: Jul 24, 2023

FCC ID: 2A22Z-W312

Prepared for

Botslab, Inc.

919 North Market Street, Suite 950, Wilmington, New Castle, Delaware, USA

Prepared by

Guangdong Global Testing Technology Co., Ltd.

Room 101-105, 203-210, Building 1, No.2, Keji 8 Road, Songshan Lake Park, Dongguan city, Guangdong, People' s Republic of China, 523808

**This report shall not be reproduced, except in full, without the written approval of
Guangdong Global Testing Technology Co., Ltd.**

Revision History

<u>Rev.</u>	<u>Issue Date</u>	<u>Revisions</u>	<u>Revised By</u>
<u>V0</u>	<u>Jul 24, 2023</u>	<u>Initial Issue</u>	<u>Win</u>

Summary of Test Results			
Test Item	Clause	Limit/Requirement	Result
Antenna Requirement	N/A	FCC Part 15.203, FCC Part 15.407(a)(1) (2)	Pass
6 dB AND 26 dB emission bandwidth	KDB 789033 D02 v02r01 Section C.1	FCC Part 15.407 (a)(2)(5)	Pass
Maximum conducted output power	KDB 789033 D02 v02r01 Section E.3.a (Method PM)	FCC Part 15.407 (a)(1)(2)(3)	Pass
Peak Power Spectral Density	KDB 789033 D02 v02r01 Section F	FCC Part 15.407 (a)(1)(2)(3)	Pass
Radiated Emissions and Band Edge Measurement	KDB 789033 D02 v02r01 Section G.3, G.4, G.5, and G.6	FCC Part 15.407 (b)(1)(2)(3)(4)(6), FCC Part 15.209/205	Pass
FREQUENCY STABILITY		FCC 15.407 (g)	Pass
Dynamic Frequency Selection (Slave)	KDB 905462 D03 Client Without DFS New Rules v01r02	FCC Part 15.407 (h)	Pass
Dynamic Frequency Selection (Master)	KDB 905462 D02 UNII DFS Compliance Procedures New Rules v02	FCC Part 15.407 (h)	N/A
AC Power Line Conducted Emission	ANSI C63.10-2013, Clause 6.2.	FCC Part 15.407 (b)(6), FCC Part 15.207	Pass
Duty Cycle	ANSI C63.10-2013, Clause 12.2	None; for reporting purposes only.	Pass

Note:

1. N/A: In this whole report not applicable.

*The measurement result for the sample received is <Pass> according to <FCC 47 CFR Part 15.407> when <Accuracy Method> decision rule is applied.

CONTENTS

1.	ATTESTATION OF TEST RESULTS.....	5
2.	TEST METHODOLOGY.....	6
3.	FACILITIES AND ACCREDITATION.....	6
4.	CALIBRATION AND UNCERTAINTY	7
4.1.	<i>MEASURING INSTRUMENT CALIBRATION</i>	<i>7</i>
4.2.	<i>MEASUREMENT UNCERTAINTY.....</i>	<i>7</i>
5.	EQUIPMENT UNDER TEST	8
5.1.	<i>DESCRIPTION OF EUT</i>	<i>8</i>
5.2.	<i>CHANNEL LIST</i>	<i>8</i>
5.3.	<i>MAXIMUM AVERAGE EIRP</i>	<i>9</i>
5.4.	<i>THE WORSE CASE POWER SETTING PARAMETER</i>	<i>10</i>
5.5.	<i>DESCRIPTION OF AVAILABLE ANTENNAS</i>	<i>12</i>
5.6.	<i>SUPPORT UNITS FOR SYSTEM TEST</i>	<i>12</i>
5.7.	<i>SETUP DIAGRAM</i>	<i>12</i>
6.	MEASURING EQUIPMENT AND SOFTWARE USED.....	14
7.	ANTENNA PORT TEST RESULTS	16
7.1.	<i>6dB AND 26dB EMISSION BANDWIDTH.....</i>	<i>16</i>
7.2.	<i>Maximum conducted output power</i>	<i>18</i>
7.3.	<i>Peak Power Spectral Density.....</i>	<i>20</i>
7.4.	<i>Frequency Stability</i>	<i>22</i>
7.5.	<i>Dynamic Frequency Selection (Slave)</i>	<i>24</i>
7.6.	<i>Duty Cycle</i>	<i>27</i>
8.	RADIATED TEST RESULTS	28
9.	ANTENNA REQUIREMENT	34
10.	AC POWER LINE CONDUCTED EMISSION	35
11.	TEST DATA.....	37
	APPENDIX: PHOTOGRAPHS OF TEST CONFIGURATION	38
	APPENDIX: PHOTOGRAPHS OF THE EUT	39

1. ATTESTATION OF TEST RESULTS

Applicant Information

Company Name: Botslab, Inc.
 Address: 919 North Market Street, Suite 950, Wilmington, New Castle, Delaware, USA

Manufacturer Information

Company Name: Botslab, Inc.
 Address: 919 North Market Street, Suite 950, Wilmington, New Castle, Delaware, USA

EUT Information

EUT Name: Botslab Outdoor Pan/Tilt Camera Pro
 Model: W312
 Brand: N/A
 Sample Received Date: Jun 08, 2023
 Sample Status: Normal
 Sample ID: A23060231 001
 Date of Tested: Jun 08, 2023 to Jul 24, 2023

APPLICABLE STANDARDS	
STANDARD	TEST RESULTS
FCC 47 CFR Part 15.407	Pass

Prepared By:

Win Huang

Win Huang
 Project Engineer

Checked By:

Alan He

Alan He
 Manager

Approved By:

Shawn Wen

Shawn Wen
 General Manager



2. TEST METHODOLOGY

All tests were performed in accordance with the standard FCC 47 CFR Part 15.407, DD

3. FACILITIES AND ACCREDITATION

Accreditation Certificate	<p>A2LA (Certificate No.: 6947.01) Guangdong Global Testing Technology Co., Ltd. has been assessed and proved to be in compliance with A2LA.</p> <p>FCC (FCC Designation No.: CN1343) Guangdong Global Testing Technology Co., Ltd. has been recognized to perform compliance testing on equipment subject to Supplier's Declaration of Conformity (SDoC) and Certification rules</p> <p>ISED (Company No.: 30714) Guangdong Global Testing Technology Co., Ltd. has been registered and fully described in a report filed with ISED. The Company Number is 30714 and the test lab Conformity Assessment Body Identifier (CABID) is CN0148.</p>
---------------------------	--

Note: All tests measurement facilities use to collect the measurement data are located at Room 101-105, 203-210, Building 1, No.2, Keji 8 Road, Songshan Lake Park, Dongguan city, Guangdong, People's Republic of China, 523808

4. CALIBRATION AND UNCERTAINTY

4.1. MEASURING INSTRUMENT CALIBRATION

The measuring equipment utilized to perform the tests documented in this report has been calibrated in accordance with the manufacturer's recommendations and is traceable to recognized national standards.

4.2. MEASUREMENT UNCERTAINTY

Where relevant, the following measurement uncertainty levels have been estimated for tests performed on the apparatus:

Description	Limit	Uncertainties
Carrier Frequencies	$\pm 1.0E-05$	$\pm 2.2E-10$
Occupied Channel Bandwidth	-	$\pm 1.71\%$
Power	± 1.5 dB	± 1.15 dB
Power Density	± 1.5 dB	± 1.21 dB
Transmitter unwanted emissions outside the 5 GHz RLAN bands		
30 MHz to 1 GHz	± 3 dB	± 0.80 dB
1 GHz to 26GHz	± 3 dB	± 2.42 dB
Transmitter unwanted emissions inside the 5 GHz RLAN bands		
5 150 MHz to 5 350 MHz and 5 470 MHz to 5 725 MHz	± 3 dB	± 1.69 dB
Receiver Spurious emission		
30 MHz to 1 GHz	± 3 dB	± 0.80 dB
1 GHz to 26GHz	± 3 dB	± 2.42 dB

Test Item	Uncertainty
Radiation Emission	4.62 dB (30 MHz ~ 1 GHz)
	3.50 dB (1 GHz ~ 18 GHz)
	4.24 dB (18 GHz ~ 26 GHz)
Note: This uncertainty represents an expanded uncertainty expressed at approximately the 95 % confidence level using a coverage factor of k=2.	

5. EQUIPMENT UNDER TEST

5.1. DESCRIPTION OF EUT

EUT Name		Botslab Outdoor Pan/Tilt Camera Pro
Model		W312
Hardware Version		K6PRO_PVT_V1.0
Software Version		K6PRO_MP_v1.0.58.1539
Ratings		ADAPTER: MODEL: TEKA-TB120100US INPUT: 100-240V~ 50/60Hz 0.35A Max OUTPUT: 12.0V 1.0A
Power Supply	AC	120V 60Hz
	DC	12.0V 1.0A

Frequency Band:	5150 MHz to 5250 MHz (U-NII-1) 5250 MHz to 5350 MHz (U-NII-2A) 5470 MHz to 5725 MHz (U-NII-2C) 5 725 MHz to 5 850 MHz (U-NII-3)
Frequency Range:	5180 MHz to 5240 MHz 5260 MHz to 5320 MHz 5500 MHz to 5700 MHz 5745 MHz to 5 825 MHz
Support Standards:	IEEE 802.11a/n
TPC Function:	Not Support
DFS Operational mode:	Slave without radar Interference detection function
Type of Modulation:	IEEE 802.11a: OFDM(64QAM, 16QAM, QPSK, BPSK) IEEE 802.11n: OFDM(64QAM, 16QAM, QPSK, BPSK)
Channel Spacing:	IEEE 802.11a/n-HT20: 20 MHz IEEE 802.11n-HT40: 40 MHz
Data Rate:	IEEE 802.11a: Up to 54 Mbps IEEE 802.11n-HT20: Up to MCS 0 IEEE 802.11n-HT40: Up to MCS 0
Maximum conducted output power:	5180 MHz to 5240 MHz: 11.48dBm 5260 MHz to 5320 MHz: 11.02dBm 5500 MHz to 5700 MHz: 11.41dBm 5745 MHz to 5825 MHz: 11.25dBm
Antenna Type:	External Antenna
Antenna Gain:	4.94dBi
Normal Test Voltage:	12 Vdc
EUT Test software:	CMD

5.2. CHANNEL LIST

UNII-1 (For Bandwidth=20MHz)		UNII-1 (For Bandwidth=40MHz)		UNII-1 (For Bandwidth=80MHz)	
Channel	Frequency (MHz)	Channel	Frequency (MHz)	Channel	Frequency (MHz)
36	5180	38	5190	42	5210

40	5200	46	5230		
44	5220				
48	5240				

UNII-2A (For Bandwidth=20MHz)		UNII-2A (For Bandwidth=40MHz)		UNII-2A (For Bandwidth=80MHz)	
Channel	Frequency (MHz)	Channel	Frequency (MHz)	Channel	Frequency (MHz)
52	5260	54	5270	58	5290
56	5280	62	5310		
60	5300				
64	5320				

UNII-2C (For Bandwidth=20MHz)		UNII-2C (For Bandwidth=40MHz)		UNII-2C (For Bandwidth=80MHz)	
Channel	Frequency (MHz)	Channel	Frequency (MHz)	Channel	Frequency (MHz)
100	5500	102	5510	106	5530
104	5520	110	5550	122	5610
108	5540	118	5590	138	5690
112	5560	126	5630		
116	5580	134	5670		
120	5600	142	5710		
124	5620				
128	5640				
132	5660				
136	5680				
140	5700				
144	5720				

UNII-3 (For Bandwidth=20MHz)		UNII-3 (For Bandwidth=40MHz)		UNII-3 (For Bandwidth=80MHz)	
Channel	Frequency (MHz)	Channel	Frequency (MHz)	Channel	Frequency (MHz)
149	5745	151	5755	155	5775
153	5765	159	5795		
157	5785				
161	5805				
165	5825				

5.3. MAXIMUM AVERAGE EIRP

UNII-1 BAND(FCC&ISED)

IEEE Std. 802.11	Frequency (MHz)	Maximum Average Conducted Power (dBm)	Max Average EIRP (dBm)
a	5150 ~ 5250	9.88	/
n HT20		11.19	/
n HT40		11.48	/

UNII-2A BAND(FCC&ISED)

IEEE Std. 802.11	Frequency (MHz)	Maximum Average Conducted Power (dBm)	Max Average EIRP (dBm)
a	5250 ~ 5350	10.81	/
n HT20		10.59	/
n HT40		11.02	/

UNII-2C BAND(FCC&ISED)

IEEE Std. 802.11	Frequency (MHz)	Maximum Average Conducted Power (dBm)	Max Average EIRP (dBm)
a	5470 ~ 5725	11.41	/
n HT20		10.03	/
n HT40		9.47	/

UNII-3 BAND(FCC&ISED)

IEEE Std. 802.11	Frequency (MHz)	Maximum Average Conducted Power (dBm)	Max Average EIRP (dBm)
a	5725 ~ 5850	11.25	/
n HT20		9.88	/
n HT40		9.67	/

5.4. THE WORSE CASE POWER SETTING PARAMETER

The Worse Case Power Setting Parameter	
Test Software	CMD

UNII-1

Mode	Rate	Channel	Soft set value
			ANT 1
11a	6M	36	51515151
		40	51515151
		48	51515151
11n HT20	MCS0	36	61616161
		40	61616161
		48	61616161
11n HT40	MCS0	38	51515151
		46	51515151

UNII-2A

Mode	Rate	Channel	Soft set value
			ANT 1
11a	6M	52	61616161
		56	61616161
		64	51515151
11n HT20	MCS0	52	61616161
		56	61616161
		64	51515151
11n HT40	MCS0	54	51515151
		62	51515151

UNII-2C

Mode	Rate	Channel	Soft set value
			ANT 1
11a	6M	100	81818181
		116	61616161
		140	61616161
11n HT20	MCS0	100	61616161
		116	51515151
		140	51515151
11n HT40	MCS0	102	51515151
		118	51515151
		134	51515151

UNII-3

Mode	Rate	Channel	Soft set value
			ANT 1
11a	6M	149	61616161
		157	61616161
		165	61616161
11n HT20	MCS0	149	51515151
		157	51515151
		165	51515151
11n HT40	MCS0	151	41414141
		159	51515151

THE WORSE CASE CONFIGURATIONS

The EUT was tested in the following configuration(s):

Controlled in test mode using a software application on the EUT supplied by customer. The application was used to enable a continuous transmission and to select the mode, test channels, bandwidth, data rates as required.

Test channels referring to section 5.4.

Maximum power setting referring to section 5.6.

Worst case Data Rates declared by the customer:

802.11a 20 mode: 6 Mbps

802.11n HT20 mode: MCS0

802.11n HT40 mode: MCS0

5.5. DESCRIPTION OF AVAILABLE ANTENNAS

Antenna No.	Frequency Band	Antenna Type	Max Antenna Gain (dBi)
1	5150-5850	External Antenna	4.94

IEE Std. 802.11	Transmit and Receive Mode	Description
802.11a	<input checked="" type="checkbox"/> 1TX, 1RX	ANT 1 can be used as transmitting/receiving antenna.
802.11n HT20	<input checked="" type="checkbox"/> 1TX, 1RX	ANT 1 can be used as transmitting/receiving antenna.
802.11n HT40	<input checked="" type="checkbox"/> 1TX, 1RX	ANT 1 can be used as transmitting/receiving antenna.

Note:

1.BT&WLAN 2.4G, BT & WLAN 5G, WLAN 2.4G & WLAN 5G can't transmit simultaneously.
(declared by client)

5.6. SUPPORT UNITS FOR SYSTEM TEST

The EUT has been tested as an independent unit

Equipment	Manufacturer	Model No.
Botslab Outdoor Pan/Tilt Camera Pro	Botslab, Inc.	W312
PC	Lenovo	T14

5.7. SETUP DIAGRAM

AC Power Line Conducted Emission:

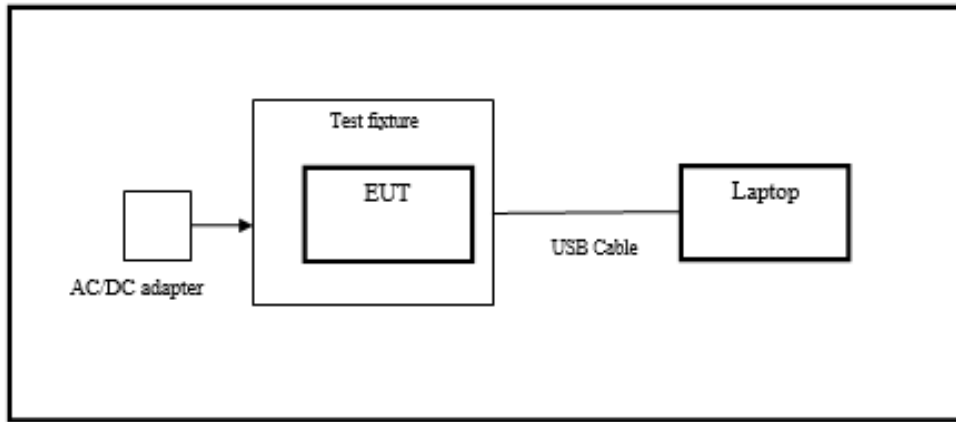

Conducted:

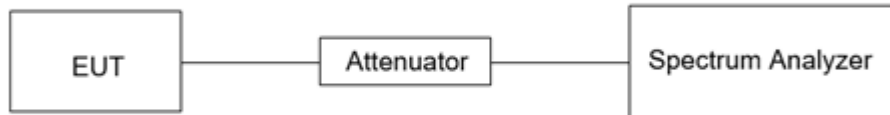

Radiated Emissions:



6. MEASURING EQUIPMENT AND SOFTWARE USED

Test Equipment of Conducted RF					
Equipment	Manufacturer	Model No.	Serial No.	Last Cal.	Due Date
Spectrum Analyzer	Rohde & Schwarz	FSV40	102257	2022/10/08	2023/10/07
EXG Analog Signal Generator	KEYSIGHT	N5173B	MY61253075	2022/10/08	2023/10/07
Vector Signal Generator	Rohde & Schwarz	SMM100A	101899	2023/03/16	2024/03/15
RF Control box	MWRF-test	MW100-RFCB	MW220926GTG	2022/10/08	2023/10/07
Wideband Radio Communication Tester	Rohde & Schwarz	CMW270	102792	2023/03/16	2024/03/15
Wideband Radio Communication Tester	Rohde & Schwarz	CMW500	103235	2022/10/08	2023/10/07
temperature humidity chamber	Espec	SH-241	SH-241-2014	2022/10/08	2023/10/07
RF Test Software	MWRF-test	MTS8310E (Ver. V2/0)	N/A	N/A	N/A
Test Equipment of Radiated emissions below 1GHz					
Equipment	Manufacturer	Model No.	Serial No.	Last Cal.	Due Date
3m Semi-anechoic Chamber	ETS	9m*6m*6m	Q2146	2022/08/30	2025/08/29
EMI Test Receiver	Rohde & Schwarz	ESCI3	101409	2022/10/08	2023/10/07
Pre-Amplifier	HzEMC	HPA-9K0130	HYP A21001	2022/10/29	2023/10/28
Biconilog Antenna	Schwarzbeck	VULB 9168	01315	2022/10/10	2025/10/09
Biconilog Antenna	ETS	3142E	00243646	2022/03/23	2025/03/22
Loop Antenna	ETS	6502	243668	2022/03/30	2025/03/29
Test Software	Farad	EZ-EMC (Ver.FA-03A2 RE)	N/A	N/A	N/A
Test Equipment of Radiated emissions above 1GHz					
Equipment	Manufacturer	Model No.	Serial No.	Last Cal.	Due Date
3m Semi-anechoic Chamber	ETS	9m*6m*6m	Q2149	2022/08/30	2025/08/29
Spectrum Analyzer	Rohde & Schwarz	FSV40	101413	2022/10/08	2023/10/07
Pre-Amplifier	A-INFO	HPA-1G1850	HYP A21003	2022/10/29	2023/10/28
Horn antenna	A-INFO	3117	246069	2022/03/11	2023/03/10
Pre-Amplifier	ZKJC	HPA-184057	HYP A21004	2022/10/29	2023/10/28
Horn antenna	ZKJC	3116C	246265	2022/03/29	2023/03/28
Test Software	Farad	EZ-EMC (Ver.FA-03A2 RE+)	N/A	N/A	N/A
Test Equipment of Conducted emissions					
Equipment	Manufacturer	Model No.	Serial No.	Last Cal.	Due Date

Shielded Room	CHENG YU	8m*5m*4m	N/A	2022/10/29	2025/10/28
EMI Test Receiver	Rohde & Schwarz	ESR3	102647	2022/12/03	2023/12/02
LISN/AMN	Rohde & Schwarz	ENV216	102843	2022/10/08	2023/10/07
NNLK 8129 RC	Schwarzbeck	NNLK 8129 RC	5046	2023/03/30	2024/03/29
Test Software	Farad	EZ-EMC (Ver. EMC-con-3A1 1+)	N/A	N/A	N/A

7. ANTENNA PORT TEST RESULTS

7.1. 6DB AND 26DB EMISSION BANDWIDTH

LIMITS

CFR 47 FCC Part15, Subpart E		
Test Item	Limit	Frequency Range (MHz)
26 dB Emission Bandwidth	For reporting purposes only.	5150 ~ 5250
26 dB Emission Bandwidth	For reporting purposes only.	5250 ~ 5350
26 dB Emission Bandwidth	For reporting purposes only.	5470 ~ 5725
6 dB Emission Bandwidth	The minimum 6 dB emission bandwidth shall be 500 kHz.	5725 ~ 5850

TEST PROCEDURE

Refer to KDB 789033 D02 General U-NII Test Procedures New Rules v02r01 section II.C1. for 26 dB Emission Bandwidth.

Connect the EUT to the spectrum analyser and use the following settings:

Center Frequency	The center frequency of the channel under test
Detector	Peak
RBW	For 6 dB Emission Bandwidth: RBW=100 kHz For 26 dB Emission bandwidth: approximately 1 % of the EBW..
VBW	For 6 dB Bandwidth: $\geq 3 \times \text{RBW}$ For 26 dB Bandwidth: $> 3 \times \text{RBW}$
Trace	Max hold
Sweep	Auto couple

- a) Use the 99 % power bandwidth function of the instrument, allow the trace to stabilize and report the measured bandwidth.
- b) Allow the trace to stabilize and measure the maximum width of the emission that is constrained by the frequencies associated with the two outermost amplitude points (upper and lower frequencies) that are attenuated by 6/26 dB relative to the maximum level measured in the fundamental emission.

Calculation for 26 dB Bandwidth of UNII-2C Straddle Channel:

For Example: Fundamental frequency: 5720 MHz

26 dB BW: 20.00 MHz

FL: 5710.16 MHz

FH: 5730.16 MHz

Turning Frequency: 5725 MHz

26 dB Bandwidth of UNII-2C Band Portion = $5725 - 5710.16 = 14.84$ MHz

Calculation for 6dB Bandwidth of UNII-3 Straddle Channel:

For Example: Fundamental frequency: 5720 MHz

6 dB BW: 16.44 MHz

FL: 5711.76 MHz

FH: 5728.2 MHz

Turning Frequency: 5725 MHz

6 dB Bandwidth of UNII-3 band Portion = $5728.2 - 5725 = 3.2$ MHz

TEST ENVIRONMENT

Temperature	22°C	Relative Humidity	51%
Atmosphere Pressure	101kPa		

TEST RESULTS

Please refer to section "Test Data" - Appendix A

7.2. MAXIMUM CONDUCTED OUTPUT POWER

LIMITS

CFR 47 FCC Part15, Subpart E		
Test Item	Limit	Frequency Range (MHz)
Conducted Output Power	<input type="checkbox"/> Outdoor Access Point: 1 W (30 dBm) <input type="checkbox"/> Indoor Access Point: 1 W (30 dBm) <input type="checkbox"/> Fixed Point-To-Point Access Points: 1 W (30 dBm) <input checked="" type="checkbox"/> Client Devices: 250 mW (24 dBm)	5150 ~ 5250
	Shall not exceed the lesser of 250 mW (24dBm) or 11 dBm + 10 log B, where B is the 26 dB emission bandwidth in megahertz.	5250 ~ 5350 5470 ~ 5725
	Shall not exceed 1 Watt (30 dBm).	5725 ~ 5850

Note:

The above limits are based upon the maximum antenna gain does not exceed 6 dBi. If transmitting antennas of directional gain greater than 6 dBi are used, the maximum conducted output power shall be reduced by the amount in dB that the directional gain of the antenna exceeds 6 dBi.

TEST PROCEDURE

Refer to KDB 789033 D02 General U-NII Test Procedures New Rules v02r01 section II.E.

Method SA-1 (trace averaging with the EUT transmitting at full power throughout each sweep):

- (i) Set span to encompass the entire emission bandwidth (EBW) (or, alternatively, the entire 99% occupied bandwidth) of the signal.
- (ii) Set RBW = 1 MHz.
- (iii) Set VBW ≥ 3 MHz.
- (iv) Number of points in sweep ≥ 2 × span / RBW. (This ensures that bin-to-bin spacing is ≤ RBW/2, so that narrowband signals are not lost between frequency bins.)
- (v) Sweep time = auto.
- (vi) Detector = power averaging (rms), if available. Otherwise, use sample detector mode.
- (vii) If transmit duty cycle < 98 %, use a video trigger with the trigger level set to enable triggering only on full power pulses. Transmitter must operate at maximum power control level for the entire duration of every sweep. If the EUT transmits continuously (i.e., with no off intervals) or at duty cycle ≥ 98 %, and if each transmission is entirely at the maximum power control level, then the trigger shall be set to “free run.”
- (viii) Trace average at least 100 traces in power averaging (rms) mode.
- (ix) Compute power by integrating the spectrum across the EBW (or, alternatively, the entire 99% occupied bandwidth) of the signal using the instrument’s band power measurement function with band limits set equal to the EBW (or occupied bandwidth) band edges. If the instrument does not have a band power function, sum the spectrum levels (in power units) at 1 MHz intervals extending across the EBW (or, alternatively, the entire 99% occupied bandwidth) of the spectrum.

Method PM (Measurement using an RF average power meter):

- (i) Measurements may be performed using a wideband RF power meter with a thermocouple detector or equivalent if all of the following conditions are satisfied:
 - a. The EUT is configured to transmit continuously or to transmit with a constant duty cycle.

- b. At all times when the EUT is transmitting, it must be transmitting at its maximum power control level.
- c. The integration period of the power meter exceeds the repetition period of the transmitted signal by at least a factor of five.
- (ii) If the transmitter does not transmit continuously, measure the duty cycle, x , of the transmitter output signal as described in II.B.
- (iii) Measure the average power of the transmitter. This measurement is an average over both the on and off periods of the transmitter.
- (iv) Adjust the measurement in dBm by adding $10 \log (1/x)$ where x is the duty cycle (e.g., $10 \log (1/0.25)$ if the duty cycle is 25 %).

Method PM-G (Measurement using a gated RF average power meter):

Measurements may be performed using a wideband gated RF power meter provided that the gate parameters are adjusted such that the power is measured only when the EUT is transmitting at its maximum power control level. Since the measurement is made only during the ON time of the transmitter, no duty cycle correction factor is required.

Straddle channel power was measured using spectrum analyzer.

TEST ENVIRONMENT

Temperature	22°C	Relative Humidity	51%
Atmosphere Pressure	101kPa		

TEST RESULTS

Please refer to section "Test Data" - Appendix A

7.3. PEAK POWER SPECTRAL DENSITY

LIMITS

CFR 47 FCC Part15, Subpart E		
Test Item	Limit	Frequency Range (MHz)
Power Spectral Density	<input type="checkbox"/> Outdoor Access Point: 17 dBm/MHz <input type="checkbox"/> Indoor Access Point: 17 dBm/MHz <input type="checkbox"/> Fixed Point-To-Point Access Points: 17 dBm/MHz <input checked="" type="checkbox"/> Client Devices: 11 dBm/MHz	5150 ~ 5250
	11 dBm/MHz	5250 ~ 5350 5470 ~ 5725
	30 dBm/500kHz	5725 ~ 5850

Note:

The above limits are based upon the maximum antenna gain does not exceed 6 dBi. If transmitting antennas of directional gain greater than 6 dBi are used, maximum power spectral density shall be reduced by the amount in dB that the directional gain of the antenna exceeds 6 dBi.

TEST PROCEDURE

Refer to KDB 789033 D02 General U-NII Test Procedures New Rules v02r01 section II.F.

Connect the EUT to the spectrum analyser and use the following settings:

For U-NII-1, U-NII-2A and U-NII-2C band:

Center Frequency	The center frequency of the channel under test
Detector	RMS
RBW	1 MHz
VBW	$\geq 3 \times \text{RBW}$
Span	Encompass the entire emissions bandwidth (EBW) of the signal
Trace	Max hold
Sweep time	Auto

For U-NII-3:

Center Frequency	The center frequency of the channel under test
Detector	RMS
RBW	500 kHz
VBW	$\geq 3 \times \text{RBW}$
Span	Encompass the entire emissions bandwidth (EBW) of the signal
Trace	Max hold
Sweep time	Auto

Allow trace to fully stabilize and Use the peak search function on the instrument to find the peak of the spectrum and record its value.

Add $10 \log (1/x)$, where x is the duty cycle, to the peak of the spectrum, the result is the Maximum PSD over 1 MHz / 500 kHz reference bandwidth.

TEST ENVIRONMENT

Temperature	22°C	Relative Humidity	51%
Atmosphere Pressure	101kPa		

TEST RESULTS

Please refer to section "Test Data" - Appendix A

7.4. Frequency Stability

LIMITS

The frequency of the carrier signal shall be maintained within band of operation.

TEST PROCEDURE

1. The EUT was placed inside an environmental chamber as the temperature in the chamber was varied between 0 °C ~ 40 °C (declared by customer).

2. The temperature was incremented by 10 °C intervals and the unit allowed to stabilize at each temperature before each measurement. The center frequency of the transmitting channel was evaluated at each temperature and the frequency deviation from the channel's center frequency was recorded.

3. The primary supply voltage is varied from 85 % to 115 % of the nominal value for non hand-carried battery and AC powered equipment. For hand-carried, battery-powered equipment, primary supply voltage is reduced to the battery operating end point which shall be specified by the manufacturer.

Connect the EUT to the spectrum analyser and use the following settings:

Center Frequency	The center frequency of the channel under test
Detector	Peak
RBW	10 kHz
VBW	$\geq 3 \times \text{RBW}$
Span	Encompass the entire emissions bandwidth (EBW) of the signal
Trace	Max hold
Sweep time	Auto

4. While maintaining a constant temperature inside the environmental chamber, turn the EUT on and record the operating frequency at startup, and at 2 minutes, 5 minutes, and 10 minutes after the EUT is energized.

5. Allow the trace to stabilize, find the peak value of the power envelope and record the frequency, then calculated the frequency drift.

TEST ENVIRONMENT

	Normal Test Conditions	Extreme Test Conditions
Relative Humidity	20 % - 75 %	/
Atmospheric Pressure	100 kPa ~102 kPa	/
Temperature	T_N (Normal Temperature): 25.1 °C	T_L (Low Temperature): 0 °C
		T_H (High Temperature): 40 °C
Supply Voltage	V_N (Normal Voltage): DC 12V	V_L (Low Voltage): DC 10.2 V
		V_H (High Voltage): DC 13.8 V

TEST ENVIRONMENT

Temperature	22°C	Relative Humidity	51%
Atmosphere Pressure	101kPa		

TEST RESULTS

Please refer to section "Test Data" - Appendix A

7.5. DYNAMIC FREQUENCY SELECTION (SLAVE)

LIMITS

(1) DFS Detection Thresholds

Table 3: DFS Detection Thresholds for Master Devices and Client Devices With Radar Detection

Maximum Transmit Power	Value (See Notes 1, 2, and 3)
EIRP ≥ 200 milliwatt	-64 dBm
EIRP < 200 milliwatt and power spectral density < 10 dBm/MHz	-62 dBm
EIRP < 200 milliwatt that do not meet the power spectral density requirement	-64 dBm

Note 1: This is the level at the input of the receiver assuming a 0 dBi receive antenna.
 Note 2: Throughout these test procedures an additional 1 dB has been added to the amplitude of the test transmission waveforms to account for variations in measurement equipment. This will ensure that the test signal is at or above the detection threshold level to trigger a DFS response.
 Note3: EIRP is based on the highest antenna gain. For MIMO devices refer to KDB Publication 662911 D01.

(2) DFS Response Requirements

Table 4: DFS Response Requirement Values

Parameter	Value
Non-occupancy period	Minimum 30 minutes
Channel Availability Check Time	60 seconds
Channel Move Time	10 seconds See Note 1.
Channel Closing Transmission Time	200 milliseconds + an aggregate of 60 milliseconds over remaining 10 second period. See Notes 1 and 2.
U-NII Detection Bandwidth	Minimum 100% of the U-NII 99% transmission power bandwidth. See Note 3.

Note 1: Channel Move Time and the Channel Closing Transmission Time should be performed with Radar Type 0. The measurement timing begins at the end of the Radar Type 0 burst.
 Note 2: The Channel Closing Transmission Time is comprised of 200 milliseconds starting at the beginning of the Channel Move Time plus any additional intermittent control signals required facilitating a Channel move (an aggregate of 60 milliseconds) during the remainder of the 10 second period. The aggregate duration of control signals will not count quiet periods in between transmissions.
 Note 3: During the U-NII Detection Bandwidth detection test, radar type 0 should be used. For each frequency step the minimum percentage of detection is 90 percent. Measurements are performed with no data traffic.

APPLICABILITY OF DFS REQUIREMENTS

A U-NII network will employ a DFS function to detect signals from radar systems and to avoid co-channel operation with these systems. This applies to the 5250-5350 MHz and/or 5470-5725 MHz bands.

Within the context of the operation of the DFS function, a U-NII device will operate in either Master Mode or Client Mode. U-NII devices operating in Client Mode can only operate in a network controlled by a U-NII device operating in Master Mode.

Table 1: Applicability of DFS Requirements Prior to Use of a Channel

Requirement	Operational Mode		
	<input type="checkbox"/> Master	<input checked="" type="checkbox"/> Client Without Radar Detection	<input type="checkbox"/> Client With Radar Detection
Non-Occupancy Period	Yes	Not required	Yes
DFS Detection Threshold	Yes	Not required	Yes
Channel Availability Check Time	Yes	Not required	Not required
U-NII Detection Bandwidth	Yes	Not required	Yes

Table 2: Applicability of DFS requirements during normal operation

Requirement	Operational Mode	
	<input type="checkbox"/> Master Device or Client with Radar Detection	<input checked="" type="checkbox"/> Client Without Radar Detection
DFS Detection Threshold	Yes	Not required
Channel Closing Transmission Time	Yes	Yes
Channel Move Time	Yes	Yes
U-NII Detection Bandwidth	Yes	Not required

Additional requirements for devices with multiple bandwidth modes	<input type="checkbox"/> Master Device or Client with Radar Detection	<input checked="" type="checkbox"/> Client Without Radar Detection
U-NII Detection Bandwidth and Statistical Performance Check	All BW modes must be tested	Not required
Channel Move Time and Channel Closing Transmission Time	Test using widest BW mode available	Test using the widest BW mode available for the link
All other tests	Any single BW mode	Not required

Note: Frequencies selected for statistical performance check should include several frequencies within the radar detection bandwidth and frequencies near the edge of the radar detection bandwidth. For 802.11 devices it is suggested to select frequencies in each of the bonded 20 MHz channels and the channel center frequency.

PARAMETERS OF RADAR TEST WAVEFORMS

This section provides the parameters for required test waveforms, minimum percentage of successful detections, and the minimum number of trials that must be used for determining DFS conformance. Step intervals of 0.1 microsecond for Pulse Width, 1 microsecond for PRI, 1 MHz for chirp width and 1 for the number of pulses will be utilized for the random determination of specific test waveforms.

Table 5 Short Pulse Radar Test Waveforms

Radar Type	Pulse Width (μsec)	PRI (μsec)	Number of Pulses	Minimum Percentage of Successful Detection	Minimum Number of Trials
0	1	1428	18	See Note 1	See Note 1
1	1	Test A	Roundup $\left\{ \left(\frac{1}{360} \right) \cdot \left(\frac{19 \cdot 10^6}{PRI_{\mu sec}} \right) \right\}$	60%	30
		Test B			
2	1-5	150-230	23-29	60%	30
3	6-10	200-500	16-18	60%	30
4	11-20	200-500	12-16	60%	30
Aggregate (Radar Types 1-4)				80%	120
Note 1: Short Pulse Radar Type 0 should be used for the detection bandwidth test, channel move time, and channel closing time tests. Test A: 15 unique PRI values randomly selected from the list of 23 PRI values in Table 5a Test B: 15 unique PRI values randomly selected within the range of 518-3066 μsec, with a minimum increment of 1 μsec, excluding PRI values selected in Test A					

A minimum of 30 unique waveforms are required for each of the Short Pulse Radar Types 2 through 4. If more than 30 waveforms are used for Short Pulse Radar Types 2 through 4, then each additional waveform must also be unique and not repeated from the previous waveforms. If more than 30 waveforms are used for Short Pulse Radar Type 1, then each additional waveform is generated with Test B and must also be unique and not repeated from the previous waveforms in Tests A or B. Test aggregate is average of the percentage of successful detections of short pulse radar types 1-4.

TEST ENVIRONMENT

Temperature	22°C	Relative Humidity	51%
Atmosphere Pressure	101kPa		

TEST RESULTS

Please refer to section "Test Data" - Appendix A

7.6. DUTY CYCLE

LIMITS

None; for reporting purposes only.

TEST PROCEDURE

Refer to KDB 789033 D02 General U-NII Test Procedures New Rules v02r01 section II.B.

The zero-span mode on a spectrum analyzer or EMI receiver, if the response time and spacing between bins on the sweep are sufficient to permit accurate measurements of the on and off times of the transmitted signal. Set the center frequency of the instrument to the center frequency of the transmission. Set RBW \geq EBW if possible; otherwise, set RBW to the largest available value. Set VBW \geq RBW. Set detector = peak or average. The zero-span measurement method shall not be used unless both RBW and VBW are $> 50/T$, where T is defined in II.B.1.a), and the number of sweep points across duration T exceeds 100. (For example, if VBW and/or RBW are limited to 3 MHz, then the zero-span method of measuring duty cycle shall not be used if $T \leq 16.7$ microseconds.)

TEST ENVIRONMENT

Temperature	22°C	Relative Humidity	51%
Atmosphere Pressure	101kPa		

TEST RESULTS

Please refer to section "Test Data" - Appendix A

8. RADIATED TEST RESULTS

LIMITS

Refer to CFR 47 FCC §15.205, §15.209 and §15.407 (b).

Radiation Disturbance Test Limit for FCC (Class B) (9 kHz ~ 1 GHz)

Emissions radiated outside of the specified frequency bands above 30 MHz			
Frequency Range (MHz)	Field Strength Limit (uV/m) at 3 m	Field Strength Limit	
		(dBuV/m) at 3 m	
		Quasi-Peak	
30 - 88	100	40	
88 - 216	150	43.5	
216 - 960	200	46	
Above 960	500	54	
Above 1000	500	Peak	Average
		74	54

FCC Emissions radiated outside of the specified frequency bands below 30 MHz		
Frequency (MHz)	Field strength (microvolts/meter)	Measurement distance (meters)
0.009-0.490	2400/F(kHz)	300
0.490-1.705	24000/F(kHz)	30
1.705-30.0	30	30

FCC Restricted bands of operation refer to FCC §15.205 (a):

MHz	MHz	MHz	GHz
0.090-0.110	16.42-16.423	399.9-410	4.5-5.15
¹ 0.495-0.505	16.69475-16.69525	608-614	5.35-5.46
2.1735-2.1905	16.80425-16.80475	960-1240	7.25-7.75
4.125-4.128	25.5-25.67	1300-1427	8.025-8.5
4.17725-4.17775	37.5-38.25	1435-1626.5	9.0-9.2
4.20725-4.20775	73-74.6	1645.5-1646.5	9.3-9.5
6.215-6.218	74.8-75.2	1660-1710	10.6-12.7
6.26775-6.26825	108-121.94	1718.8-1722.2	13.25-13.4
6.31175-6.31225	123-138	2200-2300	14.47-14.5
8.291-8.294	149.9-150.05	2310-2390	15.35-16.2
8.362-8.366	156.52475-156.52525	2483.5-2500	17.7-21.4
8.37625-8.38675	156.7-156.9	2690-2900	22.01-23.12
8.41425-8.41475	162.0125-167.17	3260-3267	23.6-24.0
12.29-12.293	167.72-173.2	3332-3339	31.2-31.8
12.51975-12.52025	240-285	3345.8-3358	36.43-36.5
12.57675-12.57725	322-335.4	3600-4400	(²)
13.36-13.41			

Note: ¹Until February 1, 1999, this restricted band shall be 0.490-0.510 MHz.

²Above 38.6c

Limits of unwanted/undesirable emission out of the restricted bands refer to CFR 47 FCC §15.407 (b) and ISED RSS-247 6.2.

LIMITS OF RADIATED EMISSION MEASUREMENT (Above 1GHz)		
Frequency Range (MHz)	EIRP Limit	Field Strength Limit (dBuV/m) at 3 m
5150~5250 MHz	PK: -27 (dBm/MHz)	PK:68.2(dBμV/m)
5250~5350 MHz		
5470~5725 MHz		
5725~5850 MHz	PK: -27 (dBm/MHz) *1 PK: 10 (dBm/MHz) *2 PK: 15.6 (dBm/MHz) *3 PK: 27 (dBm/MHz) *4	PK: 68.2(dBμV/m) *1 PK: 105.2 (dBμV/m) *2 PK: 110.8(dBμV/m) *3 PK: 122.2 (dBμV/m) *4
Note: *1 beyond 75 MHz or more above of the band edge. *2 below the band edge increasing linearly to 10 dBm/MHz at 25 MHz above. *3 below the band edge increasing linearly to a level of 15.6 dBm/MHz at 5 MHz above. *4 from 5 MHz above or below the band edge increasing linearly to a level of 27 dBm/MHz at the band edge.		

TEST PROCEDURE

Below 30 MHz

The setting of the spectrum analyser

RBW	200 Hz (From 9 kHz to 0.15 MHz)/ 9 kHz (From 0.15 MHz to 30 MHz)
VBW	200 Hz (From 9 kHz to 0.15 MHz)/ 9 kHz (From 0.15 MHz to 30 MHz)
Sweep	Auto

1. The testing follows the guidelines in ANSI C63.10-2013 clause 6.4.
2. The EUT was arranged to its worst case and then turntable (from 0 degree to 360 degrees) to find the maximum reading. A pre-amp and a high pass filter are used for the test in order to get better signal level. Both Horizontal, Face-on and Face-off polarizations of the antenna are set to make the measurement.
3. The EUT was placed on a turntable with 80 cm above ground.
4. The EUT was set 3 meters from the interference receiving antenna, which was mounted on the top of a 1 m height antenna tower.
5. The radiated emission limits are based on measurements employing a CISPR quasi-peak detector except for the frequency bands 9-90 kHz, 110-490 kHz and above 1000 MHz Radiated emission limits in these three bands are based on measurements employing an average detector.
6. For measurement below 1 GHz, the initial step in collecting conducted emission data is a spectrum analyzer peak detector mode pre-scanning the measurement frequency range. Significant peaks are then marked and then Quasi Peak and average detector mode re-measured. If the emission level of the EUT measured by the peak detector is 3 dB lower than the applicable limit, the peak emission level will be reported. Otherwise, the emission measurement will be repeated using the quasi-peak and average detector and reported.

7. Although these tests were performed other than open field site, adequate comparison measurements were confirmed against 30m open field site. Therefore sufficient tests were made to demonstrate that the alternative site produces results that correlate with the ones of tests made in an open field site based on KDB 414788.

8. The limits in CFR 47, Part 15, Subpart C, paragraph 15.209 (a), are identical to those in RSS-GEN Section 8.9, Table 6, since the measurements are performed in terms of magnetic field strength and converted to electric field strength levels (as reported in the table) using the free space impedance of 377Ω . For example, the measurement frequency X KHz resulted in a level of Y dBuV/m, which is equivalent to $Y-51.5 = Z$ dBuA/m, which has the same margin, W dB, to the corresponding RSS-GEN Table 6 limit as it has to be 15.209(a) limit.

Below 1 GHz and above 30 MHz

The setting of the spectrum analyser

RBW	120 kHz
VBW	300 kHz
Sweep	Auto
Detector	Peak/QP
Trace	Max hold

1. The testing follows the guidelines in ANSI C63.10-2013 clause 6.5.
2. The EUT was arranged to its worst case and then tune the antenna tower (from 1 m to 4 m) and turntable (from 0 degree to 360 degrees) to find the maximum reading. A pre-amp and a high pass filter are used for the test in order to get better signal level. Both horizontal and vertical polarizations of the antenna are set to make the measurement.
3. The EUT was placed on a turntable with 80 cm above ground.
4. The EUT was set 3 meters from the interference receiving antenna, which was mounted on the top of a variable height antenna tower.
5. For measurement below 1 GHz, the initial step in collecting conducted emission data is a spectrum analyzer peak detector mode pre-scanning the measurement frequency range. Significant peaks are then marked and then Quasi Peak detector mode re-measured. If the emission level of the EUT measured by the peak detector is 3 dB lower than the applicable limit, the peak emission level will be reported. Otherwise, the emission measurement will be repeated using the quasi-peak detector and reported.

Above 1 GHz

The setting of the spectrum analyser

RBW	1 MHz
VBW	PEAK: 3 MHz AVG: see note 6
Sweep	Auto
Detector	Peak
Trace	Max hold

1. The testing follows the guidelines in KDB 789033 D02 General U-NII Test Procedures New Rules v02r01 section II.G.3 ~ II.G.6.
2. The EUT was arranged to its worst case and then tune the antenna tower (from 1 m to 4 m) and turntable (from 0 degree to 360 degrees) to find the maximum reading. A pre-amp and a high pass filter are used for the test in order to get better signal level. Both horizontal and vertical polarizations of the antenna are set to make the measurement.
3. The EUT was placed on a turntable with 1.5 m above ground.
4. The EUT was set 3 meters from the interference receiving antenna, which was mounted on the top of a variable height antenna tower.
5. For measurement above 1 GHz, the emission measurement will be measured by the peak detector. This peak level, once corrected, must comply with the limit specified in Section 15.209.
6. For measurements above 1 GHz the resolution bandwidth is set to 1 MHz, then the video bandwidth is set to 3 MHz for peak measurements and 1 MHz resolution bandwidth with 1/T video bandwidth with peak detector for average measurements. For the Duty Cycle please refer to clause 7.1.ON TIME AND DUTY CYCLE.

X axis, Y axis, Z axis positions:

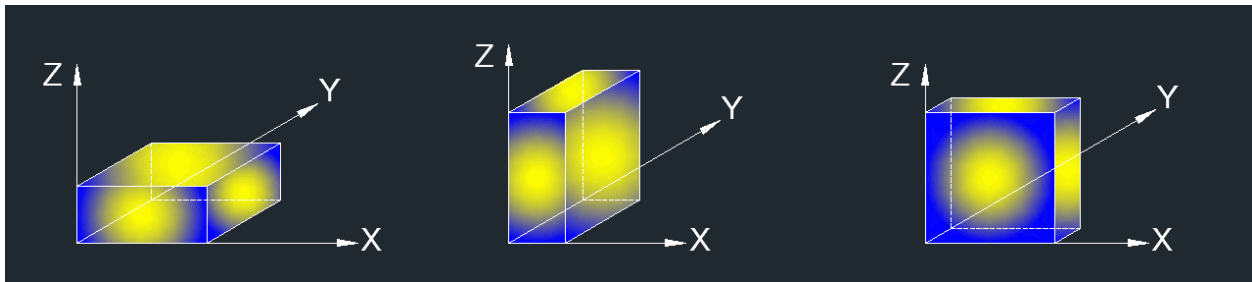

Note 1: For all radiated test, EUT in each of three orthogonal axis emissions had been tested, but only the worst case (X axis) data recorded in the report.

TEST SETUP

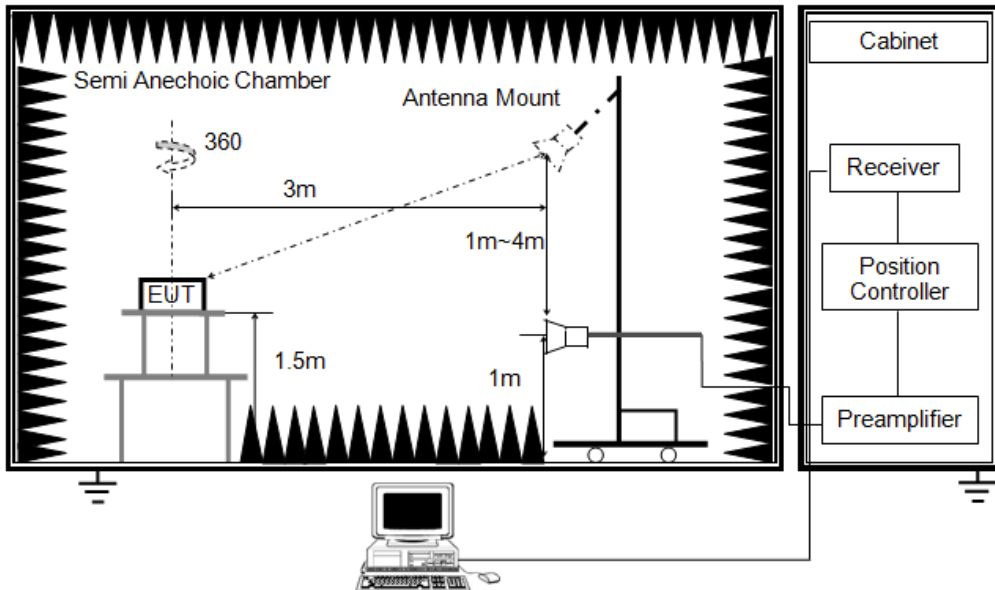
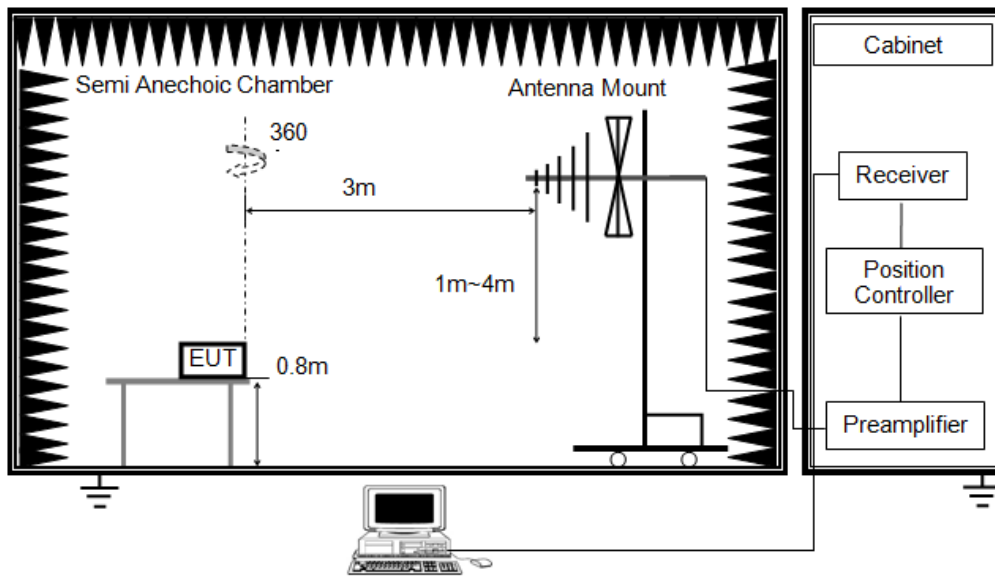
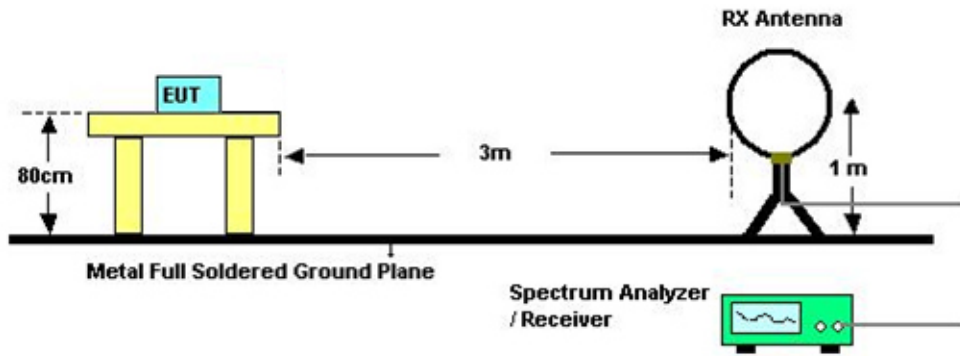

TEST ENVIRONMENT

Temperature	22°C	Relative Humidity	51%
Atmosphere Pressure	101kPa		

TEST RESULTS

Please refer to section "Test Data" - Appendix A

9. ANTENNA REQUIREMENT

REQUIREMENT

Standard	Requirement
FCC CRF Part 15.203	An intentional radiator shall be designed to ensure that no antenna other than that furnished by the responsible party shall be used with the device. The use of a permanently attached antenna or of an antenna that uses a unique coupling to the intentional radiator shall be considered sufficient to comply with the provisions of this section. The manufacturer may design the unit so that a broken antenna can be replaced by the user, but the use of a standard antenna Sunshine or electrical connector is prohibited. This requirement does not apply to carrier current devices or to devices operated under the provisions of §15.211, §15.213, §15.217, §15.219, or §15.221. Further, this requirement does not apply to intentional radiators that must be professionally installed, such as perimeter protection systems and some field disturbance sensors, or to other intentional radiators which, in accordance with §15.31(d), must be measured at the installation site. However, the installer shall be responsible for ensuring that the proper antenna is employed so that the limits in this part are not exceeded.

For intentional device, according to FCC 47 CFR Section 15.203, RSS-Gen issue 5 6.8. an intentional radiator shall be designed to ensure that no antenna other than that furnished by the responsible party shall be used with the device. And according to FCC 47 CFR Section 15.407 (a), if transmitting antennas of directional gain greater than 6dBi are used, the power shall be reduced by the amount in dB that the directional gain of the antenna exceeds 6dBi.

DESCRIPTION

Pass

10. AC POWER LINE CONDUCTED EMISSION

LIMITS

Please refer to CFR 47 FCC §15.207 (a) and ISED RSS-Gen Clause 8.8

FREQUENCY (MHz)	Quasi-peak	Average
0.15 -0.5	66 - 56 *	56 - 46 *
0.50 -5.0	56.00	46.00
5.0 -30.0	60.00	50.00

TEST PROCEDURE

Refer to ANSI C63.10-2013 clause 6.2.

The EUT is put on a table of non-conducting material that is 80 cm high. The vertical conducting wall of shielding is located 40 cm to the rear of the EUT. The power line of the EUT is connected to the AC mains through a Artificial Mains Network (A.M.N.). A EMI Measurement Receiver (R&S Test Receiver ESR3) is used to test the emissions from both sides of AC line. According to the requirements in Section 6.2 of ANSI C63.10-2013. Conducted emissions from the EUT measured in the frequency range between 0.15 MHz and 30 MHz using CISPR Quasi-Peak and average detector mode. The bandwidth of EMI test receiver is set at 9 kHz.

The arrangement of the equipment is installed to meet the standards and operating in a manner, which tends to maximize its emission characteristics in a normal application.

TEST SETUP

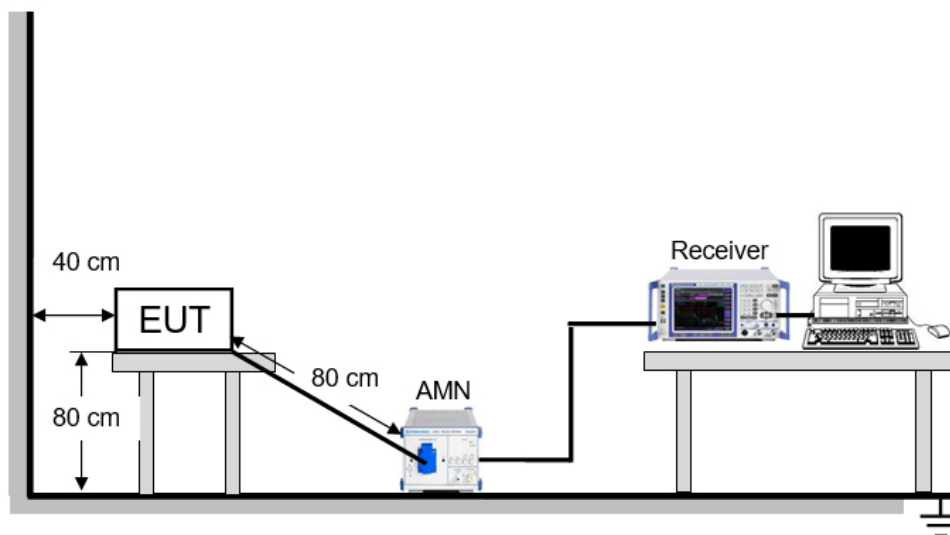

TEST ENVIRONMENT

Temperature	26°C	Relative Humidity	54%
Atmosphere Pressure	101kPa		

TEST RESULTS

Please refer to section "Test Data" - Appendix A

11. TEST DATA

Please refer to section "Test Data" - Appendix A

APPENDIX: PHOTOGRAPHS OF TEST CONFIGURATION

Please refer to test report: E04A23060231F00101

APPENDIX: PHOTOGRAPHS OF THE EUT

Please refer to test report: E04A23060231F00101

END OF REPORT