

**CFR 47 FCC PART 15 SUBPART E  
ISED RSS-247 ISSUE 2 (U-NII)**

**TEST REPORT**

*For*

**Botslab Outdoor Dual-Lens Camera**

**MODEL NUMBER: W302**

**REPORT NUMBER: E01A23040871F00103**

**ISSUE DATE: Jul 17, 2023**

**FCC ID: 2A22Z-W302**

**IC: 27673-W302**

*Prepared for*

**Botslab, Inc.**

**919 North Market Street, Suite 950, Wilmington, New Castle, Delaware, USA**

*Prepared by*

**Dong Guan Anci Electronic Technology Co., Ltd.**

**1-2 Floor, Building A, No.11, Headquarters 2 Road, Songshan, Lake Hi-tech Industrial Development Zone, Dongguan City, Guangdong Pr., China.**

**This report shall not be reproduced, except in full, without the written approval of  
Dong Guan Anci Electronic Technology Co., Ltd.**

Revision History

Rev.	Issue Date	Revisions	Revised By
V0	Jul 17, 2023	Initial Issue	Duke

### Summary of Test Results

Summary of Test Results			
Test Item	Clause	Limit/Requirement	Result
ON TIME AND DUTY CYCLE	ANSI C63.10-2013, Clause 12.2	None; for reporting purposes only.	Pass
6dB AND 26dB EMISSION BANDWIDTH AND 99% OCCUPIED BANDWIDTH	KDB 789033 D02 v02r01 Section C.1	FCC Part 15.407 (a)(2)(5), RSS-247 Issue 2, Clause 6.2.1.2 RSS-Gen Clause 6.6	Pass
CONDUCTED OUTPUT POWER	KDB 789033 D02 v02r01 Section E.3.a (Method PM)	FCC 15.407 (a) RSS-247 Clause 6.2	Pass
POWER SPECTRAL DENSITY	KDB 789033 D02 v02r01 Section F	FCC 15.407 (a) RSS-247 Clause 6.2	Pass
AC Power Line Conducted Emission	ANSI C63.10-2013, Clause 6.2.	FCC 15.207 RSS-GEN Clause 8.8	Pass
Radiated Emissions and Band Edge Measurement	KDB 789033 D02 v02r01 Section G.3, G.4, G.5, and G.6	FCC 15.407 (b) FCC 15.209 FCC 15.205 RSS-247 Clause 6.2 RSS-GEN Clause 8.9	Pass
FREQUENCY STABILITY		FCC 15.407 (g)	Pass
Dynamic Frequency Selection (Slave)	KDB 905462 D03 Client Without DFS New Rules v01r02	FCC Part 15.407 (h), RSS-247 Issue 2 Clause 6.3	Pass
Dynamic Frequency Selection (Master)	KDB 905462 D02 UNII DFS Compliance Procedures New Rules v02	FCC Part 15.407 (h), RSS-247 Issue 2 Clause 6.3	N/A
Antenna Requirement	N/A	FCC 47 CFR Part 15.203/ 15.407(a)(1) (2), RSS-Gen Issue 5, Clause 6.8	Pass

Note:

1. N/A: In this whole report not applicable.

\*The measurement result for the sample received is <Pass> according to <CFR 47 FCC PART 15 SUBPART E ISED RSS-247 ISSUE 2 (U-NII)> when <Accuracy Method> decision rule is applied.

## CONTENTS

<b>1. ATTESTATION OF TEST RESULTS .....</b>	<b>5</b>
<b>2. TEST METHODOLOGY .....</b>	<b>6</b>
<b>3. FACILITIES AND ACCREDITATION .....</b>	<b>6</b>
<b>4. CALIBRATION AND UNCERTAINTY .....</b>	<b>7</b>
4.1. <i>MEASURING INSTRUMENT CALIBRATION .....</i>	<i>7</i>
4.2. <i>MEASUREMENT UNCERTAINTY .....</i>	<i>7</i>
<b>5. EQUIPMENT UNDER TEST .....</b>	<b>8</b>
5.1. <i>DESCRIPTION OF EUT .....</i>	<i>8</i>
5.2. <i>CHANNEL LIST .....</i>	<i>9</i>
5.3. <i>MAXIMUM AVERAGE EIRP .....</i>	<i>10</i>
5.4. <i>THE WORSE CASE POWER SETTING PARAMETER .....</i>	<i>11</i>
5.5. <i>DESCRIPTION OF AVAILABLE ANTENNAS .....</i>	<i>14</i>
5.6. <i>SUPPORT UNITS FOR SYSTEM TEST .....</i>	<i>14</i>
5.7. <i>SETUP DIAGRAM .....</i>	<i>14</i>
<b>6. MEASURING EQUIPMENT AND SOFTWARE USED .....</b>	<b>15</b>
<b>7. ANTENNA PORT TEST RESULTS .....</b>	<b>16</b>
7.1. <i>ON TIME AND DUTY CYCLE .....</i>	<i>16</i>
7.2. <i>6dB AND 26dB EMISSION BANDWIDTH AND 99% OCCUPIED BANDWIDTH ....</i>	<i>17</i>
7.3. <i>CONDUCTED OUTPUT POWER .....</i>	<i>19</i>
7.4. <i>POWER SPECTRAL DENSITY .....</i>	<i>21</i>
7.5. <i>FREQUENCY STABILITY .....</i>	<i>23</i>
7.6. <i>Dynamic Frequency Selection (Slave) .....</i>	<i>25</i>
<b>8. RADIATED TEST RESULTS .....</b>	<b>31</b>
<b>9. AC POWER LINE CONDUCTED EMISSION .....</b>	<b>37</b>
<b>10.    ANTENNA REQUIREMENT .....</b>	<b>54</b>
<b>11.    TEST DATA .....</b>	<b>57</b>
<b>APPENDIX: PHOTOGRAPHS OF TEST CONFIGURATION .....</b>	<b>58</b>
<b>APPENDIX: PHOTOGRAPHS OF THE EUT .....</b>	<b>59</b>

# 1. ATTESTATION OF TEST RESULTS

## Applicant Information

Company Name: Botslab, Inc.  
 Address: 919 North Market Street, Suite 950, Wilmington, New Castle, Delaware, USA

## Manufacturer Information

Company Name: Botslab, Inc.  
 Address: 919 North Market Street, Suite 950, Wilmington, New Castle, Delaware, USA

## EUT Information

EUT Name: Botslab Outdoor Dual-Lens Camera  
 Model: W302  
 Brand: N/A  
 Sample Received Date: Jun 12, 2023  
 Sample Status: Normal  
 Sample ID: A23040871 004  
 Date of Tested: Jun 12, 2023 to Jul 17, 2023

APPLICABLE STANDARDS	
STANDARD	TEST RESULTS
CFR 47 FCC PART 15 SUBPART E ISED RSS-247 ISSUE 2 (U-NII)	Pass

Prepared By:



Duke  
 Project Engineer

Checked By:



Dyson  
 Project Engineer

Approved By:

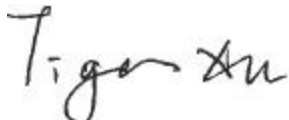

Tiger  
 Laboratory Supervisor

## 2. TEST METHODOLOGY

All tests were performed in accordance with the standard CFR 47 FCC PART 15 SUBPART E  
ISED RSS-247 ISSUE 2 (U-NII), DD

## 3. FACILITIES AND ACCREDITATION

### Site Description

Name of Firm : Dong Guan Anci Electronic Technology Co., Ltd.  
Site Location : 1-2 Floor, Building A, No.11, Headquarters 2 Road, Songshan,  
Lake Hi-tech Industrial Development Zone, Dongguan  
City, evelopment Zone, Dongguan City, Guangdong Pr., China.

## 4. CALIBRATION AND UNCERTAINTY

### 4.1. MEASURING INSTRUMENT CALIBRATION

The measuring equipment utilized to perform the tests documented in this report has been calibrated in accordance with the manufacturer's recommendations and is traceable to recognized national standards.

### 4.2. MEASUREMENT UNCERTAINTY

Where relevant, the following measurement uncertainty levels have been estimated for tests performed on the apparatus:

Where relevant, the following measurement uncertainty levels have been estimated for tests performed on the apparatus:

Description	Limit	Uncertainties
Carrier Frequencies	$\pm 1.0E-05$	$\pm 2.2E-10$
Occupied Channel Bandwidth	-	$\pm 1.71\%$
Power	$\pm 1.5$ dB	$\pm 1.15$ dB
Power Density	$\pm 1.5$ dB	$\pm 1.21$ dB
Transmitter unwanted emissions outside the 5 GHz RLAN bands		
30 MHz to 1 GHz	$\pm 3$ dB	$\pm 0.80$ dB
1 GHz to 26GHz	$\pm 3$ dB	$\pm 2.42$ dB
Transmitter unwanted emissions inside the 5 GHz RLAN bands		
5 150 MHz to 5 350 MHz and 5 470 MHz to 5 725 MHz	$\pm 3$ dB	$\pm 1.69$ dB
Receiver Spurious emission		
30 MHz to 1 GHz	$\pm 3$ dB	$\pm 0.80$ dB
1 GHz to 26GHz	$\pm 3$ dB	$\pm 2.42$ dB

Test Item	Uncertainty
Radiation Emission	4.62 dB (30 MHz ~ 1 GHz)
	3.50 dB (1 GHz ~ 18 GHz)
	4.24 dB (18 GHz ~ 26 GHz)
Note: This uncertainty represents an expanded uncertainty expressed at approximately the 95 % confidence level using a coverage factor of k=2.	

## 5. EQUIPMENT UNDER TEST

### 5.1. DESCRIPTION OF EUT

EUT Name		Botslab Outdoor Dual-Lens Camera
Model		W302
Hardware Version		A23193
Software Version		A23193
Ratings		Adapter: MODEL: SA0122-1201000UB INPUT: 100-240V~ 50-60Hz 0.5A Max OUTPUT: 12.0V 1.0A 12.0W
Power Supply	AC	120V /60Hz
	DC	12.0V 1.0A

Frequency Band:	5150 MHz to 5250 MHz (U-NII-1) 5250 MHz to 5350 MHz (U-NII-2A) 5470 MHz to 5725 MHz (U-NII-2C) 5725 MHz to 5850 MHz (U-NII-3)
Frequency Range:	5180 MHz to 5240 MHz 5260 MHz to 5320 MHz 5500 MHz to 5700 MHz(5600MHz to 5650MHz Not used in Canada) 5745 MHz to 5825 MHz
Support Standards:	IEEE 802.11a/n/ac/ax
TPC Function:	Not Support
DFS Operational mode:	Slave without radar Interference detection function
Type of Modulation:	IEEE 802.11a: OFDM(64QAM, 16QAM, QPSK, BPSK) IEEE 802.11n: OFDM(64QAM, 16QAM, QPSK, BPSK) IEEE 802.11ac: OFDM(256QAM, 64QAM, 16QAM, QPSK, BPSK) IEEE 802.11ax: OFDM(256QAM, 64QAM, 16QAM, QPSK, BPSK)
Channel Spacing:	IEEE 802.11a/n-HT20/ac-VHT20/ax-HE20: 20 MHz IEEE 802.11n-HT40/ac-VHT40/ax-HE40: 40 MHz
Data Rate:	IEEE 802.11a: Up to 54 Mbps IEEE 802.11n-HT20: Up to MCS15 IEEE 802.11n-HT40: Up to MCS15 IEEE 802.11ac-VHT20: Up to MCS8 IEEE 802.11ac-VHT40: Up to MCS9 IEEE 802.11ax-HE20: Up to MCS8 IEEE 802.11ax-HE40: Up to MCS9
Number of Channels:	5150 MHz to 5250 MHz: 4 for IEEE 802.11a/n-HT20/ac-VHT20 2 for IEEE 802.11n-HT40/ac-VHT40 5250 MHz to 5350 MHz: 4 for IEEE 802.11a/n-HT20/ac-VHT20 2 for IEEE 802.11n-HT40/ac-VHT40 5470 MHz to 5725 MHz: 11 for IEEE 802.11a/n-HT20/ac-VHT20 5 for IEEE 802.11n-HT40/ac-VHT40



	5725 MHz to 5850 MHz: 5 for IEEE 802.11a/n-HT20/ac-VHT20 2 for IEEE 802.11n-HT40/ac-VHT40
Maximum conducted output power:	5180 MHz to 5240 MHz: 15.80dBm 5260 MHz to 5320 MHz: 14.87dBm 5500 MHz to 5700 MHz: 14.75dBm 5745 MHz to 5825 MHz: 14.84dBm
Antenna Type:	External Antenna
Antenna Gain:	4.84dBi
Normal Test Voltage:	12 Vdc
EUT Test software:	SecureCRT

**5.2. CHANNEL LIST**

UNII-1 (For Bandwidth=20MHz)		UNII-1 (For Bandwidth=40MHz)		UNII-1 (For Bandwidth=80MHz)	
Channel	Frequency (MHz)	Channel	Frequency (MHz)	Channel	Frequency (MHz)
36	5180	38	5190	42	5210
40	5200	46	5230		
44	5220				
48	5240				

UNII-2A (For Bandwidth=20MHz)		UNII-2A (For Bandwidth=40MHz)		UNII-2A (For Bandwidth=80MHz)	
Channel	Frequency (MHz)	Channel	Frequency (MHz)	Channel	Frequency (MHz)
52	5260	54	5270	58	5290
56	5280	62	5310		
60	5300				
64	5320				

UNII-2C (For Bandwidth=20MHz)		UNII-2C (For Bandwidth=40MHz)		UNII-2C (For Bandwidth=80MHz)	
Channel	Frequency (MHz)	Channel	Frequency (MHz)	Channel	Frequency (MHz)
100	5500	102	5510	106	5530
104	5520	110	5550	122	5610
108	5540	118	5590	138	5690
112	5560	126	5630		
116	5580	134	5670		
120	5600	142	5710		
124	5620				
128	5640				
132	5660				
136	5680				
140	5700				
144	5720				

UNII-3 (For Bandwidth=20MHz)		UNII-3 (For Bandwidth=40MHz)		UNII-3 (For Bandwidth=80MHz)	
---------------------------------	--	---------------------------------	--	---------------------------------	--

Channel	Frequency (MHz)	Channel	Frequency (MHz)	Channel	Frequency (MHz)
149	5745	151	5755	155	5775
153	5765	159	5795		
157	5785				
161	5805				
165	5825				

**5.3. MAXIMUM AVERAGE EIRP**

**UNII-1 BAND(FCC&ISED)**

IEEE Std. 802.11	Frequency (MHz)	Maximum Average Conducted Power (dBm)	Max Average EIRP (dBm)
a	5150 ~ 5250	15.80	20.64
n HT20		13.52	18.36
n HT40		13.15	17.99
ac VHT20		13.65	18.49
ac VHT40		13.20	18.04
11ax HE20		13.32	18.16
11ax HE40		13.24	18.08

**UNII-2A BAND(FCC&ISED)**

IEEE Std. 802.11	Frequency (MHz)	Maximum Average Conducted Power (dBm)	Max Average EIRP (dBm)
a	5250 ~ 5350	14.43	19.27
n HT20		14.87	19.71
n HT40		14.15	18.99
ac VHT20		14.54	19.38
ac VHT40		13.56	18.49
11ax HE20		14.82	19.66
11ax HE40		13.41	18.25

**UNII-2C BAND(FCC&ISED)**

IEEE Std. 802.11	Frequency (MHz)	Maximum Average Conducted Power (dBm)	Max Average EIRP (dBm)
a	5470 ~ 5725	13.49	18.33
n HT20		13.51	18.35
n HT40		14.33	19.17
ac VHT20		13.60	18.44
ac VHT40		14.31	19.15
11ax HE20		13.47	18.31
11ax HE40		14.23	19.07

**UNII-3 BAND(FCC&ISED)**

IEEE Std. 802.11	Frequency (MHz)	Maximum Average Conducted Power	Max Average EIRP (dBm)
------------------	-----------------	---------------------------------	------------------------

		(dBm)	
a	5725 ~ 5850	14.25	19.09
n HT20		14.44	19.28
n HT40		13.63	18.47
ac VHT20		14.25	19.09
ac VHT40		13.78	18.62
11ax HE20		14.39	19.23
11ax HE40		13.64	18.48

**5.4. THE WORSE CASE POWER SETTING PARAMETER**

The Worse Case Power Setting Parameter	
Test Software	SecureCRT

UNII-1

Mode	Rate	Channel	Soft set value
			ANT 1
11a	6M	36	11
		40	11
		48	11
11n HT20	MCS0	36	11
		40	11
		48	11
11n HT40	MCS0	38	11
		46	11
11ac VHT20	MCS0	36	11
		40	11
		48	11
11ac VHT40	MCS0	38	11
		46	11
11ax HE20	MCS0	36	11
		40	11
		48	11
11ax HE40	MCS0	38	11
		46	11

UNII-2A

Mode	Rate	Channel	Soft set value
			ANT 1
11a	6M	52	11
		56	11
		64	11
11n HT20	MCS0	52	11
		56	11
		64	11
11n HT40	MCS0	54	11
		62	11
11ac VHT20	MCS0	52	11
		56	11

		64	11
11ac VHT40	MCS0	54	11
		62	11
11ax HE20	MCS0	52	11
		56	11
		64	11
11ax HE40	MCS0	54	11
		62	11

UNII-2C

Mode	Rate	Channel	Soft set value
			ANT 1
11a	6M	100	10
		116	10
		140	10
11n HT20	MCS0	100	10
		116	10
		140	10
11n HT40	MCS0	102	10
		118	10
		134	10
11ac VHT20	MCS0	100	10
		116	10
		140	10
11ac VHT40	MCS0	102	10
		118	10
		134	10
11ax HE20	MCS0	100	10
		116	10
		140	10
11ax HE40	MCS0	102	10
		118	10
		134	10

UNII-3

Mode	Rate	Channel	Soft set value
			ANT 1
11a	6M	149	10
		157	10
		165	10
11n HT20	MCS0	149	10
		157	10
		165	10
11n HT40	MCS0	151	10
		159	10
11ac VHT20	MCS0	149	10
		157	10
		165	10
11ac VHT40	MCS0	151	10
		159	10
11ax HE20	MCS0	149	10

		157	10
		165	10
11ax HE40	MCS0	151	10
		159	10

## THE WORSE CASE CONFIGURATIONS

The EUT was tested in the following configuration(s):

Controlled in test mode using a software application on the EUT supplied by customer. The application was used to enable a continuous transmission and to select the mode, test channels, bandwidth, data rates as required.

Test channels referring to section 5.4.

Maximum power setting referring to section 5.4.

Worst case Data Rates declared by the customer:

802.11a mode: 6 Mbps  
 802.11n HT20 mode: MCS0  
 802.11n HT40 mode: MCS0  
 802.11ac VHT20 mode: MCS0  
 802.11ac VHT40 mode: MCS0  
 802.11ax HE20 mode: MCS0  
 802.11ax HE40 mode: MCS0

### 5.5. DESCRIPTION OF AVAILABLE ANTENNAS

Antenna No.	Frequency Band	Antenna Type	Max Antenna Gain (dBi)
1	5150-5850	External Antenna	4.78

IEE Std. 802.11	Transmit and Receive Mode	Description
802.11a	☒ 1TX, 1RX	ANT 1 can be used as transmitting/receiving antenna.
802.11n HT20	☒ 1TX, 1RX	ANT 1 can be used as transmitting/receiving antenna.
802.11n HT40	☒ 1TX, 1RX	ANT 1 can be used as transmitting/receiving antenna.
802.11ac VHT20	☒ 1TX, 1RX	ANT 1 can be used as transmitting/receiving antenna.
802.11ac VHT40	☒ 1TX, 1RX	ANT 1 can be used as transmitting/receiving antenna.
802.11ax HE20	☒ 1TX, 1RX	ANT 1 can be used as transmitting/receiving antenna.
802.11ax HE40	☒ 1TX, 1RX	ANT 1 can be used as transmitting/receiving antenna.

Note:  
 1. BT&WLAN 2.4G, BT & WLAN 5G, WLAN 2.4G & WLAN 5G can't transmit simultaneously.  
 (declared by client)

### 5.6. SUPPORT UNITS FOR SYSTEM TEST

The EUT has been tested as an independent unit

Equipment	Manufacturer	Model No.
Botslab Outdoor Dual-Lens Camera	Botslab, Inc.	W302
PC	Lenovo	T14

### 5.7. SETUP DIAGRAM

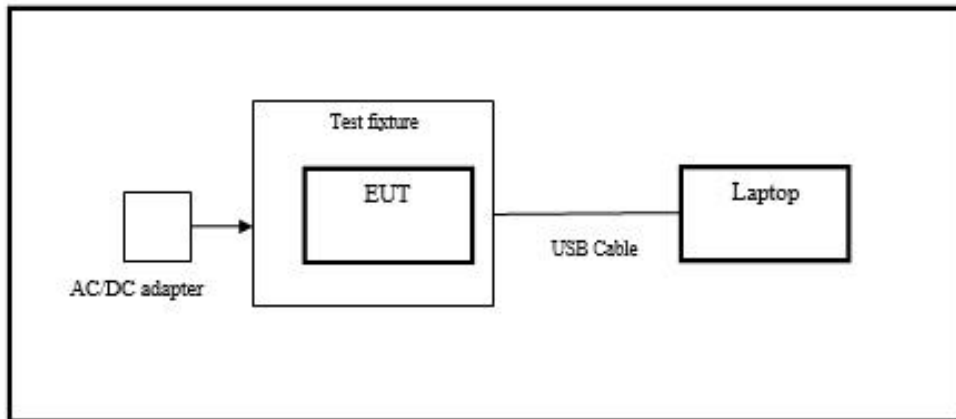

## 6. MEASURING EQUIPMENT AND SOFTWARE USED

Test Equipment of Conducted RF					
Equipment	Manufacturer	Model No.	Serial No.	Last Cal.	Due Date
Spectrum Analyzer	Rohde & Schwarz	FSV40	US40240623	2022-10-29	2023-10-28
MXG Vector Signal Generator	KEYSIGHT	N5182B	MY61250185	2022/10/8	2023/10/7
EXG Analog Signal Generator	KEYSIGHT	N5173B	My61252603	2022/10/8	2023/10/7
USB RF Power sensor	RadiPower	RPR3006W	17100015SNO88	2022/10/8	2023/10/7
USB RF Power sensor	RadiPower	RPR3006W	17100015SNO89	2022/10/8	2023/10/7
RF Test Software	MWRF-test	MTS 8310	N/A	N/A	N/A
Radio Frequency control box	MWRF-test	MW200-RFCB	MW220111 ANCI	2023/05/09	2024/5/10
Radio Frequency control box	MWRF-test	MW200-RFCB 2#	/	2023/05/09	2024/5/10
temperature humidity chamber	Espec	SH-241	SH-241-2014	2022/10/8	2023/10/7
Test Equipment of Radiated emissions below 1GHz					
Equipment	Manufacturer	Model No.	Serial No.	Last Cal.	Due Date
EMI Test Receiver	ROHDE&SCHWARZ	ESCI	100302	2023/05/09	2024/5/10
Bilog Antenna	Schwarzbeck	VULB9163	VULB9163-1290	2022/12/12	2023/12/11
RF Cable	ZKJC	ZT06S-NJ-NJ-11M	19060398	2023/05/09	2024/5/10
RF Cable	ZKJC	ZT06S-NJ-NJ-0.5M	19060400	2023/05/09	2024/5/10
RF Cable	ZKJC	ZT06S-NJ-NJ-2.5M	19060404	2023/05/09	2024/5/10
EMI Test Receiver	ROHDE&SCHWARZ	ESPI7	100502	2022/10/8	2023/10/7
3m Semi-anechoic Chamber	Keysight	9m*6m*6m	N/A	2021/11/13	2024/11/12
Test Equipment of Radiated emissions above 1GHz					
Equipment	Manufacturer	Model No.	Serial No.	Last Cal.	Due Date
Low noise Amplifiers	A-INFO	LA1018N4009	J1013130524001	2023/05/09	2024/5/10
Horn antenna	A-INFO	LB-10180-SF	J2031090612123	2023/05/09	2024/5/10
RF Cable	ZKJC	ZT26-NJ-NJ-11M	19060401	2023/05/09	2024/5/10
RF Cable	ZKJC	ZT26-NJ-NJ-2.5M	19060402	2023/05/09	2024/5/10
RF Cable	ZKJC	ZT26-NJ-NJ-0.5M	19060403	2023/05/09	2024/5/10

Spectrum Analyzer	Rohde & Schwarz	FSV40	US40240623	2022-10-29	2023-10-28
3m Semi-anechoic Chamber	Keysight	9m*6m*6m	N/A	2021/11/13	2024/11/12
Test Software	Farad	EZ-EMC (Ver.FA-03A2 RE)	N/A	N/A	N/A
<b>Test Equipment of Conducted emissions</b>					
<b>Equipment</b>	<b>Manufacturer</b>	<b>Model No.</b>	<b>Serial No.</b>	<b>Last Cal.</b>	<b>Due Date</b>
EMI Test Receiver	ROHDE&SCHWARZ	ESCI	101358	2023/05/09	2024/5/10
1# Shielded Room	chengyu	8m*4m*3.3m	N/A	2022/11/22	2025/11/21
LISN	ROHDE&SCHWARZ	ENV216	101413	2022/10/8	2023/10/7
Test Software	Farad	EZ-EMC (Ver.ANCI-3A1)	N/A	N/A	N/A
RF Cable	N/A	ZT06S-NJ-NJ-2.5M	19044022	2023/05/09	2024/5/10

## 7. ANTENNA PORT TEST RESULTS

### 7.1. ON TIME AND DUTY CYCLE

#### LIMITS

None; for reporting purposes only.

#### TEST PROCEDURE

Refer to KDB 789033 D02 General U-NII Test Procedures New Rules v02r01 section II.B.

The zero-span mode on a spectrum analyzer or EMI receiver, if the response time and spacing between bins on the sweep are sufficient to permit accurate measurements of the on and off times of the transmitted signal. Set the center frequency of the instrument to the center frequency of the transmission. Set RBW  $\geq$  EBW if possible; otherwise, set RBW to the largest available value. Set VBW  $\geq$  RBW. Set detector = peak or average. The zero-span measurement method shall not be used unless both RBW and VBW are  $> 50/T$ , where T is defined in II.B.1.a), and the number of sweep points across duration T exceeds 100. (For example, if VBW and/or RBW are limited to 3 MHz, then the zero-span method of measuring duty cycle shall not be used if  $T \leq 16.7$  microseconds.)

#### TEST ENVIRONMENT

Temperature	22°C	Relative Humidity	51%
Atmosphere Pressure	101kPa		

#### TEST RESULTS

Please refer to section "Test Data" - Appendix C1~C4



## 7.2. 6DB AND 26DB EMISSION BANDWIDTH AND 99% OCCUPIED BANDWIDTH

### LIMITS

CFR 47 FCC Part15, Subpart E ISED RSS-247 ISSUE 2		
Test Item	Limit	Frequency Range (MHz)
26 dB Emission Bandwidth	For reporting purposes only.	5150 ~ 5250
26 dB Emission Bandwidth	For reporting purposes only.	5250 ~ 5350
26 dB Emission Bandwidth	For reporting purposes only.	5470 ~ 5725 (For FCC) 5470 ~ 5600 (For ISED) 5650 ~ 5725 (For ISED)
6 dB Emission Bandwidth	The minimum 6 dB emission bandwidth shall be 500 kHz.	5725 ~ 5850
99 % Occupied Bandwidth	For reporting purposes only.	5150 ~ 5825 (For ISED)

### TEST PROCEDURE

Refer to KDB 789033 D02 General U-NII Test Procedures New Rules v02r01 section II.C1. for 26 dB Emission Bandwidth; section II.C2. for 6 dB Emission Bandwidth; section II.D. for 99 % Occupied Bandwidth.

Connect the EUT to the spectrum analyser and use the following settings:

Center Frequency	The center frequency of the channel under test
Detector	Peak
RBW	For 6 dB Emission Bandwidth: RBW=100 kHz For 26 dB Emission bandwidth: approximately 1 % of the EBW. For 99 % Occupied Bandwidth: approximately 1 % ~ 5 % of the OBW.
VBW	For 6 dB Bandwidth: $\geq 3 \times \text{RBW}$ For 26 dB Bandwidth: $> 3 \times \text{RBW}$ For 99 % Bandwidth: $> 3 \times \text{RBW}$
Trace	Max hold
Sweep	Auto couple

a) Use the 99 % power bandwidth function of the instrument, allow the trace to stabilize and report the measured bandwidth.

b) Allow the trace to stabilize and measure the maximum width of the emission that is constrained by the frequencies associated with the two outermost amplitude points (upper and lower frequencies) that are attenuated by 6/26 dB relative to the maximum level measured in the fundamental emission.

### **Calculation for 99 % Bandwidth of UNII-2C and UNII-3 Straddle Channel:**

For Example: Fundamental Frequency: 5720 MHz

99 % OBW: 21.00 MHz

Turning Frequency: 5725 MHz

99 % Bandwidth of UNII-2C Band Portion =  $(5725 - (5720 - (21.00/2))) = 15.50 \text{ MHz}$

99 % Bandwidth of UNII-3 Band Portion =  $(5720 + (21.00/2) - 5725) = 5.50 \text{ MHz}$

**Calculation for 26 dB Bandwidth of UNII-2C Straddle Channel:**

For Example: Fundamental frequency: 5720 MHz

26 dB BW: 20.00 MHz

FL: 5710.16 MHz

FH: 5730.16 MHz

Turning Frequency: 5725 MHz

26 dB Bandwidth of UNII-2C Band Portion =  $5725 - 5710.16 = 14.84$  MHz**Calculation for 6dB Bandwidth of UNII-3 Straddle Channel:**

For Example: Fundamental frequency: 5720 MHz

6 dB BW: 16.44 MHz

FL: 5711.76 MHz

FH: 5728.2 MHz

Turning Frequency: 5725 MHz

6 dB Bandwidth of UNII-3 band Portion =  $5728.2 - 5725 = 3.2$  MHz**TEST ENVIRONMENT**

Temperature	22°C	Relative Humidity	51%
Atmosphere Pressure	101kPa		

**TEST RESULTS**

Please refer to section "Test Data" - Appendix C1~C4

### 7.3. CONDUCTED OUTPUT POWER

#### LIMITS

CFR 47 FCC Part15, Subpart E		
Test Item	Limit	Frequency Range (MHz)
Conducted Output Power	<input type="checkbox"/> Outdoor Access Point: 1 W (30 dBm) <input type="checkbox"/> Indoor Access Point: 1 W (30 dBm) <input type="checkbox"/> Fixed Point-To-Point Access Points: 1 W (30 dBm) <input checked="" type="checkbox"/> Client Devices: 250 mW (24 dBm)	5150 ~ 5250
	Shall not exceed the lesser of 250 mW (24dBm) or 11 dBm + 10 log B, where B is the 26 dB emission bandwidth in megahertz.	5250 ~ 5350 5470 ~ 5725
	Shall not exceed 1 Watt (30 dBm).	5725 ~ 5850

ISED RSS-247 ISSUE 2		
Test Item	Limit	Frequency Range (MHz)
Conducted Output Power or e.i.r.p.	The maximum e.i.r.p. shall not exceed 200 mW (23 dBm) or 10 + 10 log <sub>10</sub> B, dBm, whichever power is less. B is the 99 % emission bandwidth in megahertz.	5150 ~ 5250
	a. The maximum conducted output power shall not exceed 250 mW (24 dBm) or 11 + 10 log <sub>10</sub> B dBm, whichever is less.  b. The maximum e.i.r.p. shall not exceed 1.0 W (30 dBm) or 17 + 10 log <sub>10</sub> B dBm, whichever is less. B is the 99 % emission bandwidth in megahertz. Note that devices with a maximum e.i.r.p. greater than 500 mW shall implement TPC in order to have the capability to operate at least 6 dB below the maximum permitted e.i.r.p. of 1 W.	5250 ~ 5350 5470 ~ 5600 5650 ~ 5725
	Shall not exceed 1 Watt (30 dBm). The e.i.r.p. shall not exceed 4 W	5725 ~ 5850

#### Note:

The above limits are based upon the maximum antenna gain does not exceed 6 dBi. If transmitting antennas of directional gain greater than 6 dBi are used, the maximum conducted output power shall be reduced by the amount in dB that the directional gain of the antenna exceeds 6 dBi.

#### TEST PROCEDURE

Refer to KDB 789033 D02 General U-NII Test Procedures New Rules v02r01 section II.E.

#### Method SA-1 (trace averaging with the EUT transmitting at full power throughout each sweep):

- (i) Set span to encompass the entire emission bandwidth (EBW) (or, alternatively, the entire 99% occupied bandwidth) of the signal.
- (ii) Set RBW = 1 MHz.
- (iii) Set VBW ≥ 3 MHz.

- (iv) Number of points in sweep  $\geq 2 \times \text{span} / \text{RBW}$ . (This ensures that bin-to-bin spacing is  $\leq \text{RBW}/2$ , so that narrowband signals are not lost between frequency bins.)
- (v) Sweep time = auto.
- (vi) Detector = power averaging (rms), if available. Otherwise, use sample detector mode.
- (vii) If transmit duty cycle  $< 98\%$ , use a video trigger with the trigger level set to enable triggering only on full power pulses. Transmitter must operate at maximum power control level for the entire duration of every sweep. If the EUT transmits continuously (i.e., with no off intervals) or at duty cycle  $\geq 98\%$ , and if each transmission is entirely at the maximum power control level, then the trigger shall be set to "free run."
- (viii) Trace average at least 100 traces in power averaging (rms) mode.
- (ix) Compute power by integrating the spectrum across the EBW (or, alternatively, the entire 99% occupied bandwidth) of the signal using the instrument's band power measurement function with band limits set equal to the EBW (or occupied bandwidth) band edges. If the instrument does not have a band power function, sum the spectrum levels (in power units) at 1 MHz intervals extending across the EBW (or, alternatively, the entire 99% occupied bandwidth) of the spectrum.

**Method PM (Measurement using an RF average power meter):**

- (i) Measurements may be performed using a wideband RF power meter with a thermocouple detector or equivalent if all of the following conditions are satisfied:
- The EUT is configured to transmit continuously or to transmit with a constant duty cycle.
  - At all times when the EUT is transmitting, it must be transmitting at its maximum power control level.
  - The integration period of the power meter exceeds the repetition period of the transmitted signal by at least a factor of five.
- (ii) If the transmitter does not transmit continuously, measure the duty cycle,  $x$ , of the transmitter output signal as described in II.B.
- (iii) Measure the average power of the transmitter. This measurement is an average over both the on and off periods of the transmitter.
- (iv) Adjust the measurement in dBm by adding  $10 \log (1/x)$  where  $x$  is the duty cycle (e.g.,  $10 \log (1/0.25)$  if the duty cycle is 25 %).

**Method PM-G (Measurement using a gated RF average power meter):**

Measurements may be performed using a wideband gated RF power meter provided that the gate parameters are adjusted such that the power is measured only when the EUT is transmitting at its maximum power control level. Since the measurement is made only during the ON time of the transmitter, no duty cycle correction factor is required.

Straddle channel power was measured using spectrum analyzer.

**TEST ENVIRONMENT**

Temperature	22°C	Relative Humidity	51%
Atmosphere Pressure	101kPa		

**TEST RESULTS**

Please refer to section "Test Data" - Appendix C1~C4

## 7.4. POWER SPECTRAL DENSITY

### LIMITS

CFR 47 FCC Part15, Subpart E		
Test Item	Limit	Frequency Range (MHz)
Power Spectral Density	<input type="checkbox"/> Outdoor Access Point: 17 dBm/MHz <input type="checkbox"/> Indoor Access Point: 17 dBm/MHz <input type="checkbox"/> Fixed Point-To-Point Access Points: 17 dBm/MHz <input checked="" type="checkbox"/> Client Devices: 11 dBm/MHz	5150 ~ 5250
	11 dBm/MHz	5250 ~ 5350 5470 ~ 5725
	30 dBm/500kHz	5725 ~ 5850

ISED RSS-247 ISSUE 2		
Test Item	Limit	Frequency Range (MHz)
Power Spectral Density	The e.i.r.p. spectral density shall not exceed 10 dBm in any 1.0 MHz band.	5150 ~ 5250
	The power spectral density shall not exceed 11 dBm in any 1.0 MHz band.	5250 ~ 5350 5470 ~ 5600 5650 ~ 5725
	30 dBm / 500 kHz	5725 ~ 5850

#### Note:

The above limits are based upon the maximum antenna gain does not exceed 6 dBi.

If transmitting antennas of directional gain greater than 6 dBi are used, maximum power spectral density shall be reduced by the amount in dB that the directional gain of the antenna exceeds 6 dBi.

### TEST PROCEDURE

Refer to KDB 789033 D02 General U-NII Test Procedures New Rules v02r01 section II.F.

Connect the EUT to the spectrum analyser and use the following settings:

For U-NII-1, U-NII-2A and U-NII-2C band:

Center Frequency	The center frequency of the channel under test
Detector	RMS
RBW	1 MHz
VBW	$\geq 3 \times \text{RBW}$
Span	Encompass the entire emissions bandwidth (EBW) of the signal
Trace	Max hold
Sweep time	Auto

For U-NII-3:

Center Frequency	The center frequency of the channel under test
Detector	RMS
RBW	500 kHz
VBW	$\geq 3 \times \text{RBW}$
Span	Encompass the entire emissions bandwidth (EBW) of the signal
Trace	Max hold
Sweep time	Auto

Allow trace to fully stabilize and Use the peak search function on the instrument to find the peak of the spectrum and record its value.

Add  $10 \log (1/x)$ , where x is the duty cycle, to the peak of the spectrum, the result is the Maximum PSD over 1 MHz / 500 kHz reference bandwidth.

#### **TEST ENVIRONMENT**

Temperature	22°C	Relative Humidity	51%
Atmosphere Pressure	101kPa		

#### **TEST RESULTS**

Please refer to section "Test Data" - Appendix C1~C4

## 7.5. FREQUENCY STABILITY

### LIMITS

The frequency of the carrier signal shall be maintained within band of operation.

### TEST PROCEDURE

1. The EUT was placed inside an environmental chamber as the temperature in the chamber was varied between 0 °C ~ 40 °C (declared by customer).

2. The temperature was incremented by 10 °C intervals and the unit allowed to stabilize at each temperature before each measurement. The center frequency of the transmitting channel was evaluated at each temperature and the frequency deviation from the channel's center frequency was recorded.

3. The primary supply voltage is varied from 85 % to 115 % of the nominal value for non hand-carried battery and AC powered equipment. For hand-carried, battery-powered equipment, primary supply voltage is reduced to the battery operating end point which shall be specified by the manufacturer.

Connect the EUT to the spectrum analyser and use the following settings:

Center Frequency	The center frequency of the channel under test
Detector	Peak
RBW	10 kHz
VBW	$\geq 3 \times \text{RBW}$
Span	Encompass the entire emissions bandwidth (EBW) of the signal
Trace	Max hold
Sweep time	Auto

4. While maintaining a constant temperature inside the environmental chamber, turn the EUT on and record the operating frequency at startup, and at 2 minutes, 5minutes, and 10 minutes after the EUT is energized.

5. Allow the trace to stabilize, find the peak value of the power envelope and record the frequency, then calculated the frequency drift.

### TEST ENVIRONMENT

	Normal Test Conditions	Extreme Test Conditions
Relative Humidity	20 % - 75 %	/
Atmospheric Pressure	100 kPa ~102 kPa	/
Temperature	T <sub>N</sub> (Normal Temperature): 25.1 °C	T <sub>L</sub> (Low Temperature): 0 °C
		T <sub>H</sub> (High Temperature): 40 °C
Supply Voltage	V <sub>N</sub> (Normal Voltage): DC 3.3 V	V <sub>L</sub> (Low Voltage): DC 2.805 V
		V <sub>H</sub> (High Voltage): DC 3.795 V

**TEST ENVIRONMENT**

Temperature	22°C	Relative Humidity	51%
Atmosphere Pressure	101kPa		

**TEST RESULTS**

Please refer to section "Test Data" - Appendix C1~C4



## 7.6. DYNAMIC FREQUENCY SELECTION (SLAVE)

### LIMITS

#### (1) DFS Detection Thresholds

Table 3: DFS Detection Thresholds for Master Devices and Client Devices With Radar Detection

Maximum Transmit Power	Value (See Notes 1, 2, and 3)
EIRP ≥ 200 milliwatt	-64 dBm
EIRP < 200 milliwatt and power spectral density < 10 dBm/MHz	-62 dBm
EIRP < 200 milliwatt that do not meet the power spectral density requirement	-64 dBm

Note 1: This is the level at the input of the receiver assuming a 0 dBi receive antenna.  
 Note 2: Throughout these test procedures an additional 1 dB has been added to the amplitude of the test transmission waveforms to account for variations in measurement equipment. This will ensure that the test signal is at or above the detection threshold level to trigger a DFS response.  
 Note3: EIRP is based on the highest antenna gain. For MIMO devices refer to KDB Publication 662911 D01.

#### (2) DFS Response Requirements

Table 4: DFS Response Requirement Values

Parameter	Value
Non-occupancy period	Minimum 30 minutes
Channel Availability Check Time	60 seconds
Channel Move Time	10 seconds See Note 1.
Channel Closing Transmission Time	200 milliseconds + an aggregate of 60 milliseconds over remaining 10 second period. See Notes 1 and 2.
U-NII Detection Bandwidth	Minimum 100% of the U-NII 99% transmission power bandwidth. See Note 3.

Note 1: Channel Move Time and the Channel Closing Transmission Time should be performed with Radar Type 0. The measurement timing begins at the end of the Radar Type 0 burst.  
 Note 2: The Channel Closing Transmission Time is comprised of 200 milliseconds starting at the beginning of the Channel Move Time plus any additional intermittent control signals required facilitating a Channel move (an aggregate of 60 milliseconds) during the remainder of the 10 second period. The aggregate duration of control signals will not count quiet periods in between transmissions.  
 Note 3: During the U-NII Detection Bandwidth detection test, radar type 0 should be used. For each frequency step the minimum percentage of detection is 90 percent. Measurements are performed with no data traffic.

**APPLICABILITY OF DFS REQUIREMENTS**

A U-NII network will employ a DFS function to detect signals from radar systems and to avoid co-channel operation with these systems. This applies to the 5250-5350 MHz and/or 5470-5725 MHz bands.

Within the context of the operation of the DFS function, a U-NII device will operate in either Master Mode or Client Mode. U-NII devices operating in Client Mode can only operate in a network controlled by a U-NII device operating in Master Mode.

Table 1: Applicability of DFS Requirements Prior to Use of a Channel

Requirement	Operational Mode		
	<input type="checkbox"/> Master	<input checked="" type="checkbox"/> Client Without Radar Detection	<input type="checkbox"/> Client With Radar Detection
Non-Occupancy Period	Yes	Not required	Yes
DFS Detection Threshold	Yes	Not required	Yes
Channel Availability Check Time	Yes	Not required	Not required
U-NII Detection Bandwidth	Yes	Not required	Yes

Table 2: Applicability of DFS requirements during normal operation

Requirement	Operational Mode	
	<input type="checkbox"/> Master Device or Client with Radar Detection	<input checked="" type="checkbox"/> Client Without Radar Detection
DFS Detection Threshold	Yes	Not required
Channel Closing Transmission Time	Yes	Yes
Channel Move Time	Yes	Yes
U-NII Detection Bandwidth	Yes	Not required

Additional requirements for devices with multiple bandwidth modes	<input type="checkbox"/> Master Device or Client with Radar Detection	<input checked="" type="checkbox"/> Client Without Radar Detection
U-NII Detection Bandwidth and Statistical Performance Check	All BW modes must be tested	Not required
Channel Move Time and Channel Closing Transmission Time	Test using widest BW mode available	Test using the widest BW mode available for the link
All other tests	Any single BW mode	Not required

Note: Frequencies selected for statistical performance check should include several frequencies within the radar detection bandwidth and frequencies near the edge of the radar detection bandwidth. For 802.11 devices it is suggested to select frequencies in each of the bonded 20 MHz channels and the channel center frequency.

**PARAMETERS OF RADAR TEST WAVEFORMS**

This section provides the parameters for required test waveforms, minimum percentage of successful detections, and the minimum number of trials that must be used for determining DFS conformance. Step intervals of 0.1 microsecond for Pulse Width, 1 microsecond for PRI, 1 MHz for chirp width and 1 for the number of pulses will be utilized for the random determination of specific test waveforms.

Table 5 Short Pulse Radar Test Waveforms

Radar Type	Pulse Width (µsec)	PRI (µsec)	Number of Pulses	Minimum Percentage of Successful Detection	Minimum Number of Trials
0	1	1428	18	See Note 1	See Note 1
1	1	Test A	Roundup $\left\{ \frac{1}{360} \right\}$	60%	30
		Test B			
2	1-5	150-230	23-29	60%	30
3	6-10	200-500	16-18	60%	30
4	11-20	200-500	12-16	60%	30
Aggregate (Radar Types 1-4)				80%	120
Note 1: Short Pulse Radar Type 0 should be used for the detection bandwidth test, channel move time, and channel closing time tests. Test A: 15 unique PRI values randomly selected from the list of 23 PRI values in Table 5a Test B: 15 unique PRI values randomly selected within the range of 518-3066 µsec, with a minimum increment of 1 µsec, excluding PRI values selected in Test A					

A minimum of 30 unique waveforms are required for each of the Short Pulse Radar Types 2 through 4. If more than 30 waveforms are used for Short Pulse Radar Types 2 through 4, then each additional waveform must also be unique and not repeated from the previous waveforms. If more than 30 waveforms are used for Short Pulse Radar Type 1, then each additional waveform is generated with Test B and must also be unique and not repeated from the previous waveforms in Tests A or B. Test aggregate is average of the percentage of successful detections of short pulse radar types 1-4.

**TEST ENVIRONMENT**

Temperature	22°C	Relative Humidity	51%
Atmosphere Pressure	101kPa		

**TEST RESULTS**

Both the Master and Client device were set to 802.11ax / MCS0x1 with 40 MHz channel bandwidth to ensure a stable channel loading. KDB 905462 D02 v02 UNII DFS Compliance Procedures states in Table 2 the EUT should be tested at maximum channel bandwidth (40 MHz for 802.11ax mode).

Test Frequency and channel for 802.11ax (HE40):

Transmit / Receive Channels Tested at 80 MHz Bandwidth setting:	
Channel	Frequency (MHz)
54	5270
134	5670

**Calibration**

Radar Signal 0:

5270MHz:

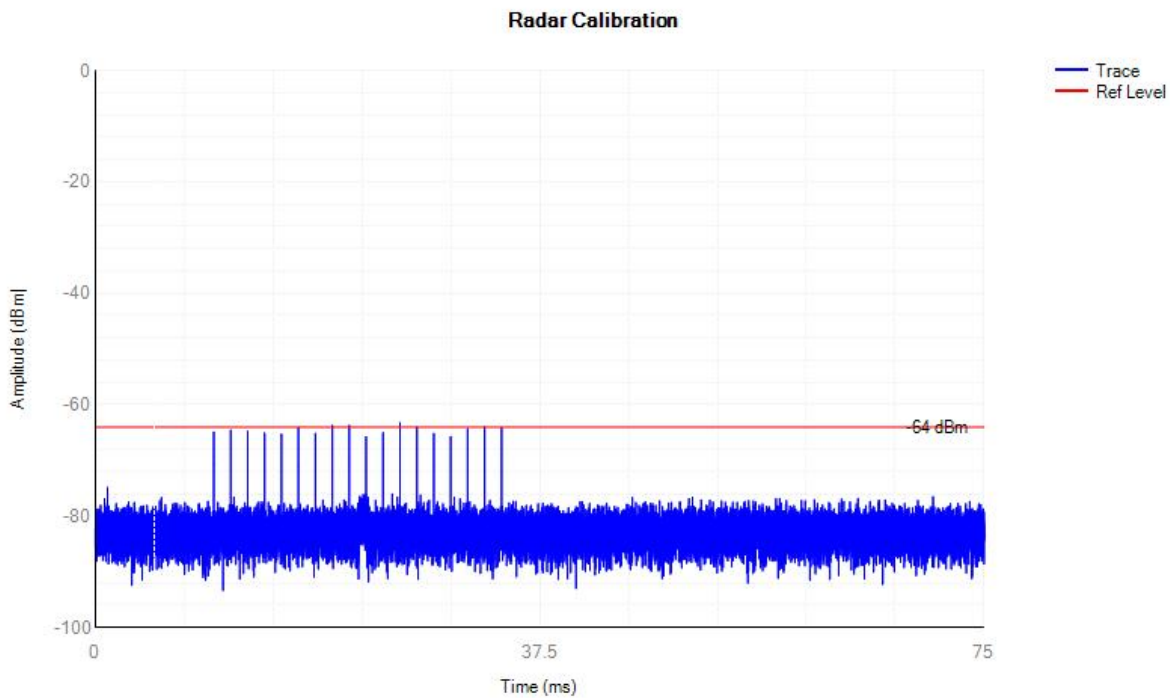

5670MHz:

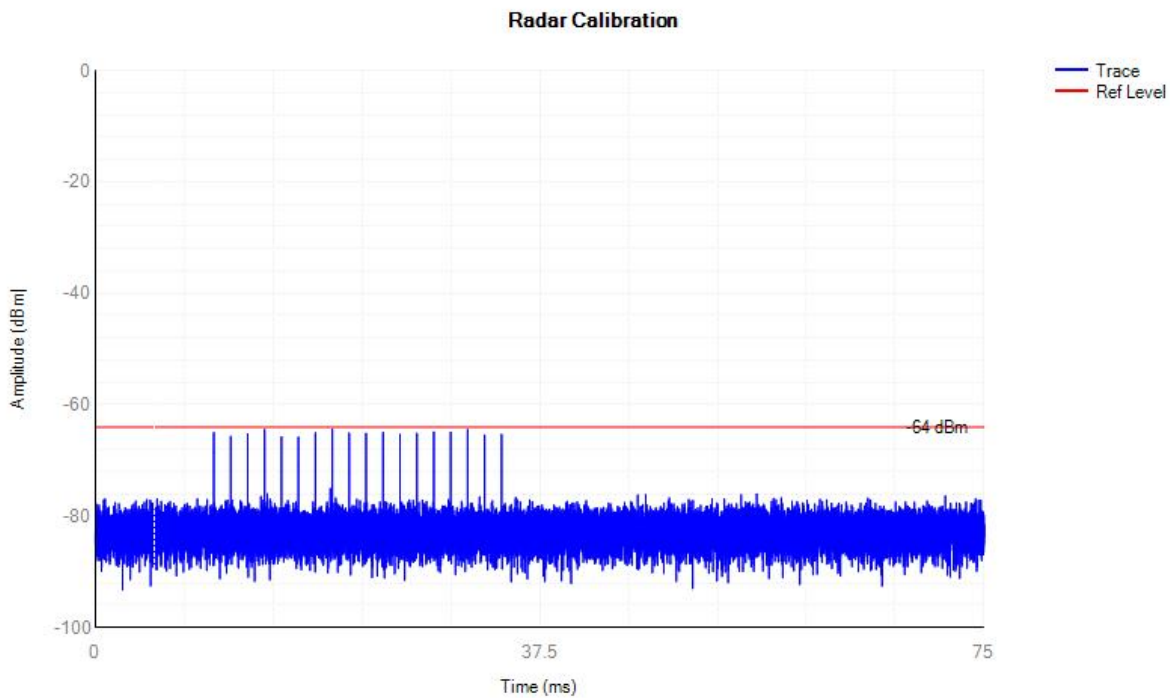

**Shutdown Time**  
5270MHz:

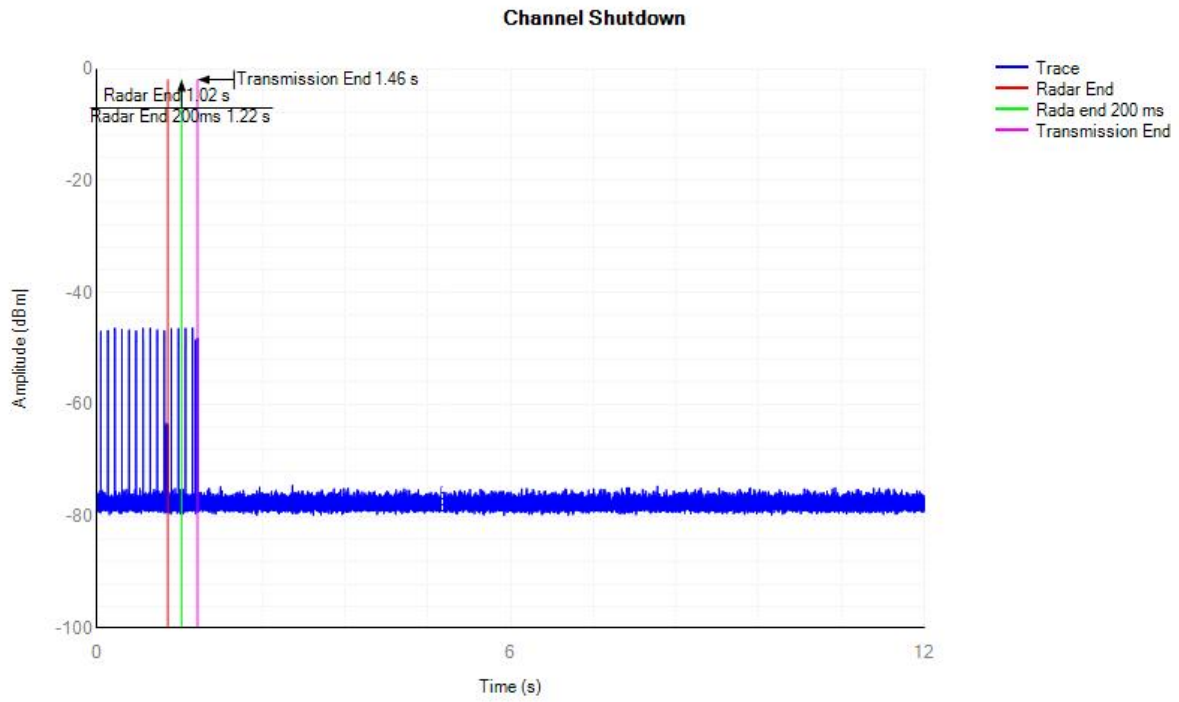

5670MHz:

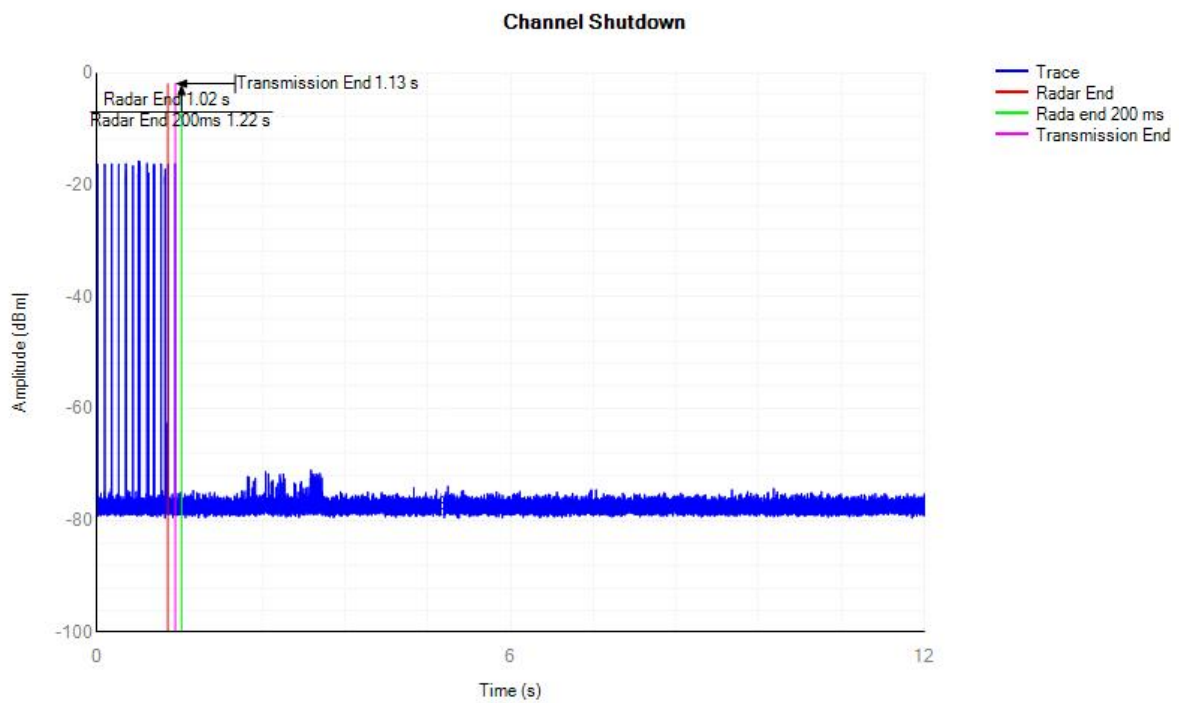

**Non-Occupancy**  
5270MHz:

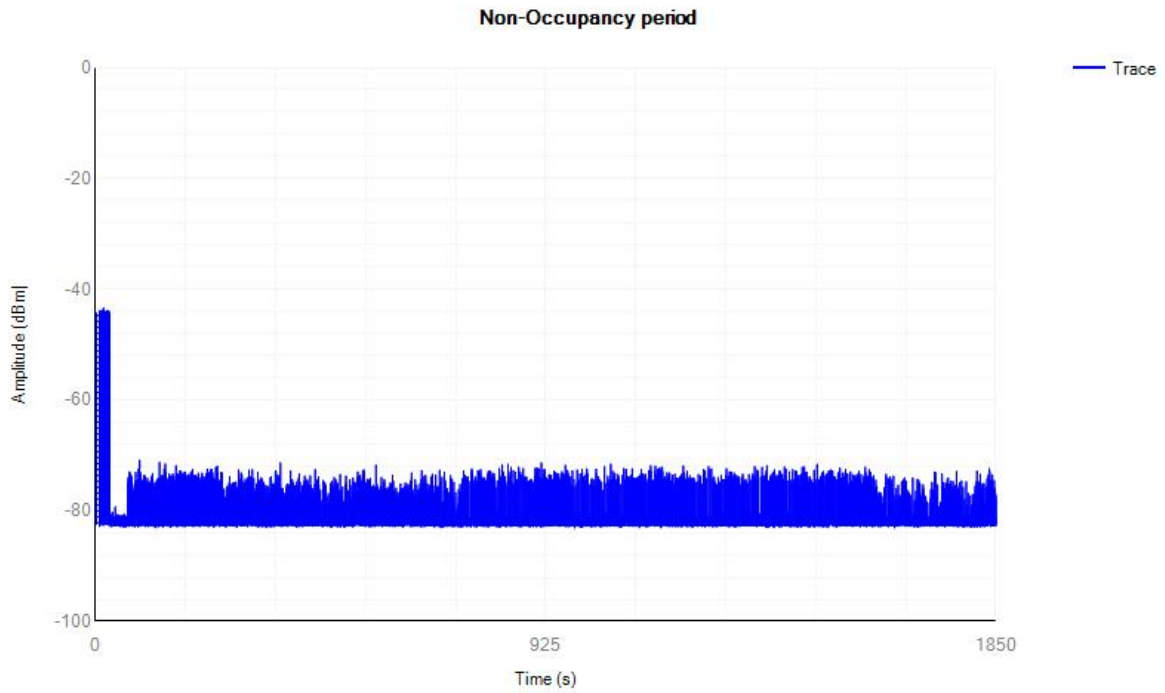

5670MHz:

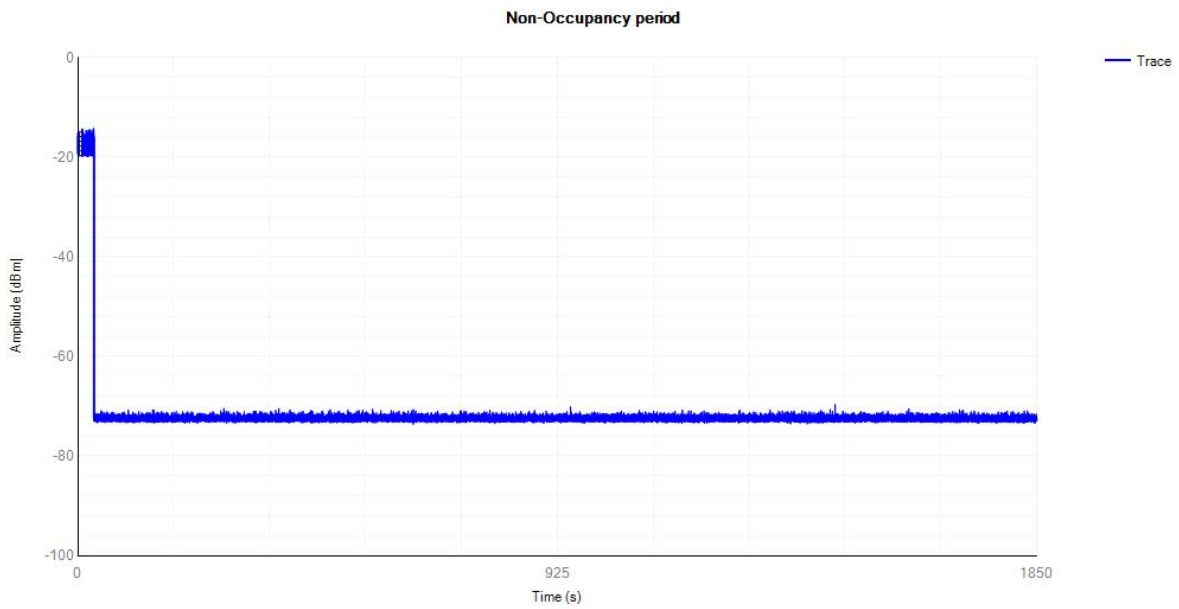

## 8. RADIATED TEST RESULTS

### LIMITS

Refer to CFR 47 FCC §15.205, §15.209 and §15.407 (b).

Refer to ISED RSS-GEN Clause 8.9, Clause 8.10 and ISED RSS-247 6.2.

Radiation Disturbance Test Limit for FCC (Class B) (9 kHz ~ 1 GHz)

Emissions radiated outside of the specified frequency bands above 30 MHz			
Frequency Range (MHz)	Field Strength Limit (uV/m) at 3 m	Field Strength Limit (dBuV/m) at 3 m	
		Quasi-Peak	
30 - 88	100	40	
88 - 216	150	43.5	
216 - 960	200	46	
Above 960	500	54	
Above 1000	500	Peak	Average
		74	54

FCC Emissions radiated outside of the specified frequency bands below 30 MHz		
Frequency (MHz)	Field strength (microvolts/meter)	Measurement distance (meters)
0.009-0.490	2400/F(kHz)	300
0.490-1.705	24000/F(kHz)	30
1.705-30.0	30	30

ISED General field strength limits at frequencies below 30 MHz

Table 6 – General field strength limits at frequencies below 30 MHz		
Frequency	Magnetic field strength (H-Field) (uA/m)	Measurement distance (m)
9 - 490 kHz <sup>Note 1</sup>	6.37/F (F in kHz)	300
490 - 1705 kHz	63.7/F (F in kHz)	30
1.705 - 30 MHz	0.08	30

**Note 1:** The emission limits for the ranges 9-90 kHz and 110-490 kHz are based on measurements employing a linear average detector.

ISED Restricted bands refer to ISED RSS-GEN Clause 8.10

Table 7 – Restricted frequency bands <sup>Note 1</sup>		
MHz	MHz	GHz
0.090 - 0.110	149.9 - 150.05	9.0 - 9.2
0.495 - 0.505	156.52475 - 156.52525	9.3 - 9.5
2.1735 - 2.1905	156.7 - 156.9	10.8 - 12.7
3.020 - 3.026	162.0125 - 167.17	13.25 - 13.4
4.125 - 4.128	167.72 - 173.2	14.47 - 14.5
4.17725 - 4.17775	240 - 285	15.35 - 16.2
4.20725 - 4.20775	322 - 335.4	17.7 - 21.4
5.677 - 5.683	399.9 - 410	22.01 - 23.12
6.215 - 6.218	608 - 614	23.6 - 24.0
6.26775 - 6.26825	960 - 1427	31.2 - 31.8
6.31175 - 6.31225	1435 - 1626.5	36.43 - 36.5
8.291 - 8.294	1645.5 - 1646.5	Above 38.6
8.362 - 8.366	1660 - 1710	
8.37625 - 8.38675	1718.8 - 1722.2	
8.41425 - 8.41475	2200 - 2300	
12.29 - 12.293	2310 - 2390	
12.51975 - 12.52025	2483.5 - 2500	
12.57675 - 12.57725	2655 - 2900	
13.36 - 13.41	3260 - 3267	
16.42 - 16.423	3332 - 3339	
16.80475 - 16.80525	3345.8 - 3358	
16.80425 - 16.80475	3500 - 4400	
25.5 - 25.67	4500 - 5150	
37.5 - 38.25	5350 - 5480	
73 - 74.6	7250 - 7750	
74.8 - 75.2	8025 - 8500	
108 - 138		

**Note 1:** Certain frequency bands listed in table 7 and in bands above 38.6 GHz are designated for licence-exempt applications. These frequency bands and the requirements that apply to related devices are set out in the 200 and 300 series of RSSs.

FCC Restricted bands of operation refer to FCC §15.205 (a):

MHz	MHz	MHz	GHz
0.090-0.110	16.42-16.423	399.9-410	4.5-5.15
<sup>1</sup> 0.495-0.505	16.69475-16.69525	608-614	5.35-5.46
2.1735-2.1905	16.80425-16.80475	960-1240	7.25-7.75
4.125-4.128	25.5-25.67	1300-1427	8.025-8.5
4.17725-4.17775	37.5-38.25	1435-1626.5	9.0-9.2
4.20725-4.20775	73-74.6	1645.5-1646.5	9.3-9.5
6.215-6.218	74.8-75.2	1660-1710	10.6-12.7
6.26775-6.26825	108-121.94	1718.8-1722.2	13.25-13.4
6.31175-6.31225	123-138	2200-2300	14.47-14.5
8.291-8.294	149.9-150.05	2310-2390	15.35-16.2
8.362-8.366	156.52475-156.52525	2483.5-2500	17.7-21.4
8.37625-8.38675	156.7-156.9	2690-2900	22.01-23.12
8.41425-8.41475	162.0125-167.17	3260-3267	23.6-24.0
12.29-12.293	167.72-173.2	3332-3339	31.2-31.8
12.51975-12.52025	240-285	3345.8-3358	36.43-36.5
12.57675-12.57725	322-335.4	3600-4400	( <sup>2</sup> )
13.36-13.41			

Note: <sup>1</sup>Until February 1, 1999, this restricted band shall be 0.490-0.510 MHz.

<sup>2</sup>Above 38.6c

Limits of unwanted/undesirable emission out of the restricted bands refer to CFR 47 FCC §15.407 (b) and ISED RSS-247 6.2.

LIMITS OF RADIATED EMISSION MEASUREMENT (Above 1GHz)



Frequency Range (MHz)	EIRP Limit	Field Strength Limit (dBuV/m) at 3 m
5150~5250 MHz	PK: -27 (dBm/MHz)	PK:68.2(dBμV/m)
5250~5350 MHz		
5470~5725 MHz		
5725~5850 MHz	PK: -27 (dBm/MHz) *1 PK: 10 (dBm/MHz) *2 PK: 15.6 (dBm/MHz) *3 PK: 27 (dBm/MHz) *4	PK: 68.2(dBμV/m) *1 PK: 105.2 (dBμV/m) *2 PK: 110.8(dBμV/m) *3 PK: 122.2 (dBμV/m) *4
<p>Note:</p> <p>*1 beyond 75 MHz or more above of the band edge.</p> <p>*2 below the band edge increasing linearly to 10 dBm/MHz at 25 MHz above.</p> <p>*3 below the band edge increasing linearly to a level of 15.6 dBm/MHz at 5 MHz above.</p> <p>*4 from 5 MHz above or below the band edge increasing linearly to a level of 27 dBm/MHz at the band edge.</p>		

### **TEST PROCEDURE**

Below 30 MHz

The setting of the spectrum analyser

RBW	200 Hz (From 9 kHz to 0.15 MHz)/ 9 kHz (From 0.15 MHz to 30 MHz)
VBW	200 Hz (From 9 kHz to 0.15 MHz)/ 9 kHz (From 0.15 MHz to 30 MHz)
Sweep	Auto

1. The testing follows the guidelines in ANSI C63.10-2013 clause 6.4.
2. The EUT was arranged to its worst case and then turntable (from 0 degree to 360 degrees) to find the maximum reading. A pre-amp and a high pass filter are used for the test in order to get better signal level. Both Horizontal, Face-on and Face-off polarizations of the antenna are set to make the measurement.
3. The EUT was placed on a turntable with 80 cm above ground.
4. The EUT was set 3 meters from the interference receiving antenna, which was mounted on the top of a 1 m height antenna tower.
5. The radiated emission limits are based on measurements employing a CISPR quasi-peak detector except for the frequency bands 9-90 kHz, 110-490 kHz and above 1000 MHz Radiated emission limits in these three bands are based on measurements employing an average detector.
6. For measurement below 1 GHz, the initial step in collecting conducted emission data is a spectrum analyzer peak detector mode pre-scanning the measurement frequency range. Significant peaks are then marked and then Quasi Peak and average detector mode re-measured. If the emission level of the EUT measured by the peak detector is 3 dB lower than the applicable limit, the peak emission level will be reported. Otherwise, the emission measurement will be repeated using the quasi-peak and average detector and reported.
7. Although these tests were performed other than open field site, adequate comparison measurements were confirmed against 30m open field site. Therefore sufficient tests were made to demonstrate that the alternative site produces results that correlate with the ones of tests made in an open field site based on KDB 414788.

8. The limits in CFR 47, Part 15, Subpart C, paragraph 15.209 (a), are identical to those in RSS-GEN Section 8.9, Table 6, since the measurements are performed in terms of magnetic field strength and converted to electric field strength levels (as reported in the table) using the free space impedance of  $377\Omega$ . For example, the measurement frequency X KHz resulted in a level of Y dBuV/m, which is equivalent to  $Y-51.5 = Z$  dBuA/m, which has the same margin, W dB, to the corresponding RSS-GEN Table 6 limit as it has to be 15.209(a) limit.

Below 1 GHz and above 30 MHz

The setting of the spectrum analyser

RBW	120 kHz
VBW	300 kHz
Sweep	Auto
Detector	Peak/QP
Trace	Max hold

1. The testing follows the guidelines in ANSI C63.10-2013 clause 6.5.
2. The EUT was arranged to its worst case and then tune the antenna tower (from 1 m to 4 m) and turntable (from 0 degree to 360 degrees) to find the maximum reading. A pre-amp and a high pass filter are used for the test in order to get better signal level. Both horizontal and vertical polarizations of the antenna are set to make the measurement.
3. The EUT was placed on a turntable with 80 cm above ground.
4. The EUT was set 3 meters from the interference receiving antenna, which was mounted on the top of a variable height antenna tower.
5. For measurement below 1 GHz, the initial step in collecting conducted emission data is a spectrum analyzer peak detector mode pre-scanning the measurement frequency range. Significant peaks are then marked and then Quasi Peak detector mode re-measured. If the emission level of the EUT measured by the peak detector is 3 dB lower than the applicable limit, the peak emission level will be reported. Otherwise, the emission measurement will be repeated using the quasi-peak detector and reported.

Above 1 GHz

The setting of the spectrum analyser

RBW	1 MHz
VBW	PEAK: 3 MHz AVG: see note 6
Sweep	Auto
Detector	Peak
Trace	Max hold

1. The testing follows the guidelines in KDB 789033 D02 General U-NII Test Procedures New Rules v02r01 section II.G.3 ~ II.G.6.
2. The EUT was arranged to its worst case and then tune the antenna tower (from 1 m to 4 m) and turntable (from 0 degree to 360 degrees) to find the maximum reading. A pre-amp and a high pass filter are used for the test in order to get better signal level. Both horizontal and vertical polarizations of the antenna are set to make the measurement.
3. The EUT was placed on a turntable with 1.5 m above ground.
4. The EUT was set 3 meters from the interference receiving antenna, which was mounted on the top of a variable height antenna tower.
5. For measurement above 1 GHz, the emission measurement will be measured by the peak detector. This peak level, once corrected, must comply with the limit specified in Section 15.209.
6. For measurements above 1 GHz the resolution bandwidth is set to 1 MHz, then the video bandwidth is set to 3 MHz for peak measurements and 1 MHz resolution bandwidth with 1/T video bandwidth with peak detector for average measurements. For the Duty Cycle please refer to clause 7.1.ON TIME AND DUTY CYCLE.

X axis, Y axis, Z axis positions:

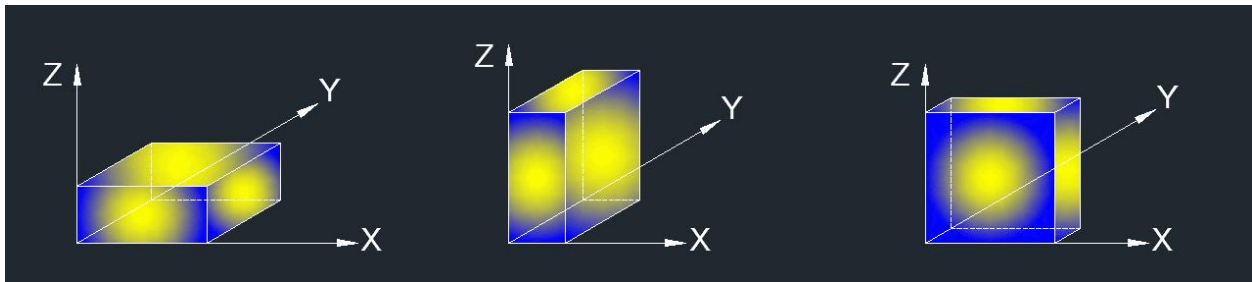

Note 1: For all radiated test, EUT in each of three orthogonal axis emissions had been tested, but only the worst case (X axis) data recorded in the report.

**TEST ENVIRONMENT**

Temperature	22°C	Relative Humidity	51%
Atmosphere Pressure	101kPa		

**TEST RESULTS**

- Undesirable radiated Spurious Emission below 1GHz (30MHz to 1GHz)

The worst result as bellow:

EUT :	Botslab Outdoor Dual-Lens Camera
MN:	W302
Mode:	A5180
Power:	DC5V
TE:	BIG
Date	2023/7/4
T/A/P	24.1°C/54%/101Kpa

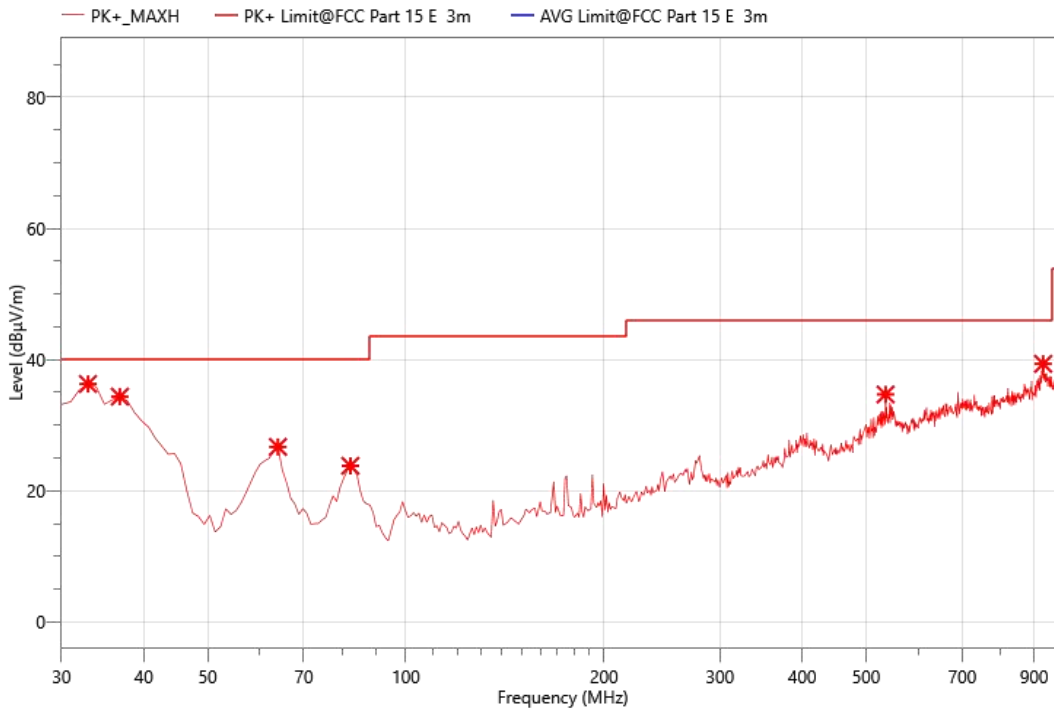

### Critical\_Freqs

No.	Freq. (MHz)	Reading (dBµV)	Meas. (dBµV/m)	Limit (dBµV/m)	Margin (dBµV/m)	Det.	Height (cm)	Pol.	Azimuth (deg)	Corr. (dB)
1	32.910	42.46	36.30	40.00	3.70	PK+	150.0	V	360.0	-6.16
2	36.790	42.76	34.37	40.00	5.63	PK+	150.0	V	360.0	-8.39
3	63.950	41.23	26.70	40.00	13.30	PK+	150.0	V	360.0	-14.53
4	82.380	38.89	23.82	40.00	16.18	PK+	150.0	V	360.0	-15.07
5	535.370	32.31	34.70	46.00	11.30	PK+	150.0	V	360.0	2.39
6	929.190	28.61	39.36	46.00	6.64	PK+	150.0	V	360.0	10.75

Note: 1. Result Level = Read Level+ Antenna Factor+ Cable Loss- Amp. Factor

EUT :	Botslab Outdoor Dual-Lens Camera
MN:	W302
Mode:	A5180
Power:	DC5V
TE:	BIG
Date	2023/7/4
T/A/P	24.1°C/54%/101Kpa

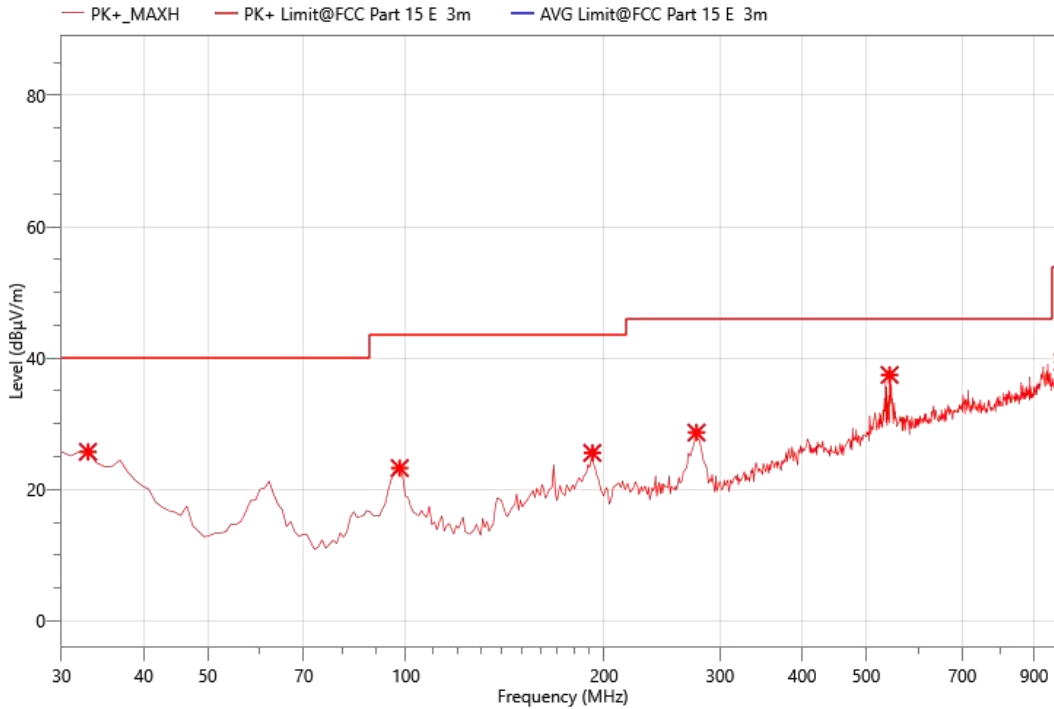

### Critical\_Freqs

No.	Freq. (MHz)	Reading (dBµV)	Meas. (dBµV/m)	Limit (dBµV/m)	Margin (dBµV/m)	Det.	Height (cm)	Pol.	Azimuth (deg)	Corr. (dB)
1	32.910	31.90	25.74	40.00	14.26	PK+	150.0	H	360.0	-6.16
2	97.900	36.83	23.27	43.50	20.23	PK+	150.0	H	360.0	-13.56
3	191.990	36.46	25.58	43.50	17.92	PK+	150.0	H	360.0	-10.88
4	276.380	35.48	28.68	46.00	17.32	PK+	150.0	H	360.0	-6.8
5	543.130	34.61	37.44	46.00	8.56	PK+	150.0	H	360.0	2.83
6	995.150	29.21	39.39	53.90	14.51	PK+	150.0	H	360.0	10.18

Note: 1. Result Level = Read Level+ Antenna Factor+ Cable Loss- Amp. Factor

- Undesirable radiated Spurious Emission Above 1GHz (1GHz to 40GHz)  
All modes has been tested and the worst result (801.11a) recorded as below:

EUT :	Botslab Outdoor Dual-Lens Camera
MN:	W302
Mode:	A5180
Power:	DC5V
TE:	BIG
Date	2023/7/4
T/A/P	24.1°C/54%/101Kpa

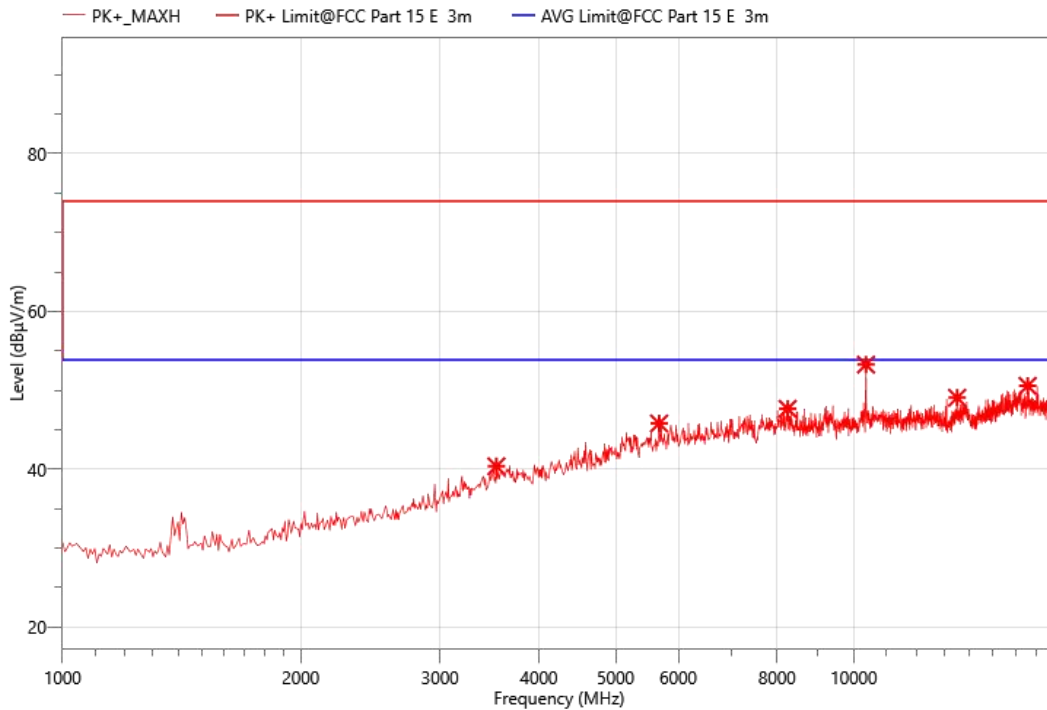

**Critical\_Freqs**

No.	Freq. (MHz)	Reading (dBµV)	Meas. (dBµV/m)	Limit (dBµV/m)	Margin (dBµV/m)	Det.	Height (cm)	Pol.	Azimuth (deg)	Corr. (dB)
1	3534.000	54.58	40.36	74.00	33.64	PK+	150.0	V	360.0	-14.22
2	5676.000	51.84	45.79	74.00	28.21	PK+	150.0	V	360.0	-6.05
3	8250.000	48.56	47.65	74.00	26.35	PK+	150.0	V	360.0	-0.91
4	10360.000	53.68	53.25	74.00	20.75	PK+	150.0	V	360.0	-0.43
5	13510.000	48.06	49.05	74.00	24.95	PK+	150.0	V	360.0	0.99
6	16585.000	46.62	50.56	74.00	23.44	PK+	150.0	V	360.0	3.94

EUT :	Botslab Outdoor Dual-Lens Camera
MN:	W302
Mode:	A5180
Power:	DC5V
TE:	BIG
Date	2023/7/4
T/A/P	24.1°C/54%/101Kpa

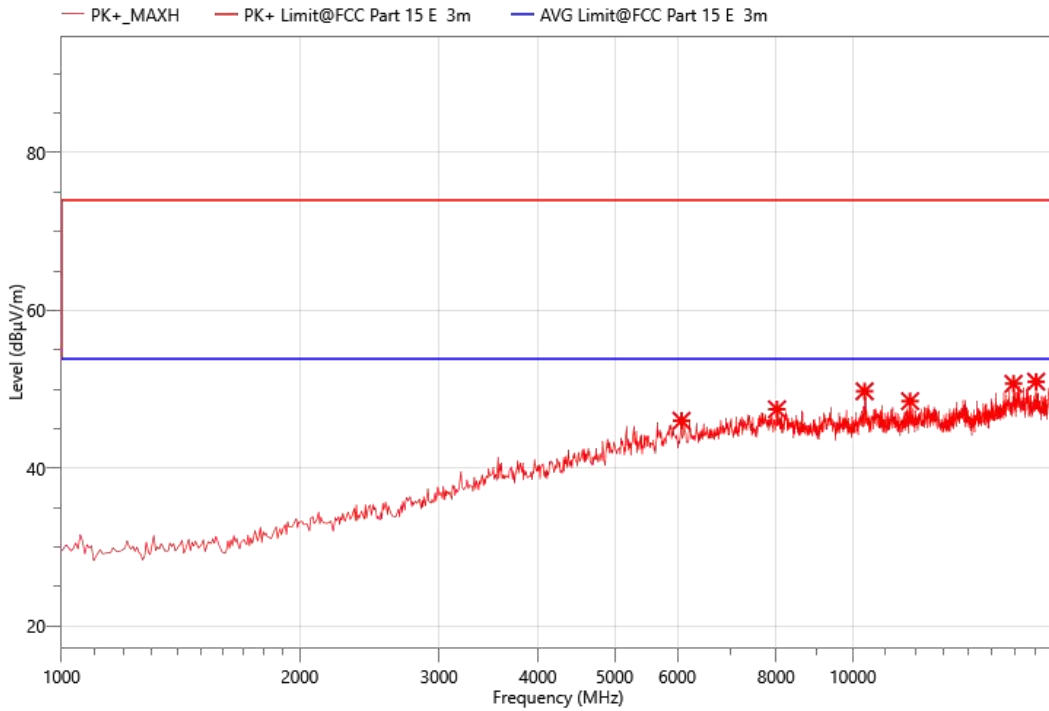

### Critical\_Freqs

No.	Freq. (MHz)	Reading (dBµV)	Meas. (dBµV/m)	Limit (dBµV/m)	Margin (dBµV/m)	Det.	Height (cm)	Pol.	Azimuth (deg)	Corr. (dB)
1	6075.000	51.36	46.01	74.00	27.99	PK+	150.0	H	360.0	-5.35
2	8020.000	49.08	47.46	74.00	26.54	PK+	150.0	H	360.0	-1.62
3	10350.000	50.16	49.74	74.00	24.26	PK+	150.0	H	360.0	-0.42
4	11815.000	48.35	48.49	74.00	25.51	PK+	150.0	H	360.0	0.14
5	15965.000	46.46	50.69	74.00	23.31	PK+	150.0	H	360.0	4.23
6	17050.000	46.95	50.96	74.00	23.04	PK+	150.0	H	360.0	4.01



EUT :	Botslab Outdoor Dual-Lens Camera
MN:	W302
Mode:	A5200
Power:	DC5V
TE:	BIG
Date	2023/7/4
T/A/P	24.1°C/54%/101Kpa

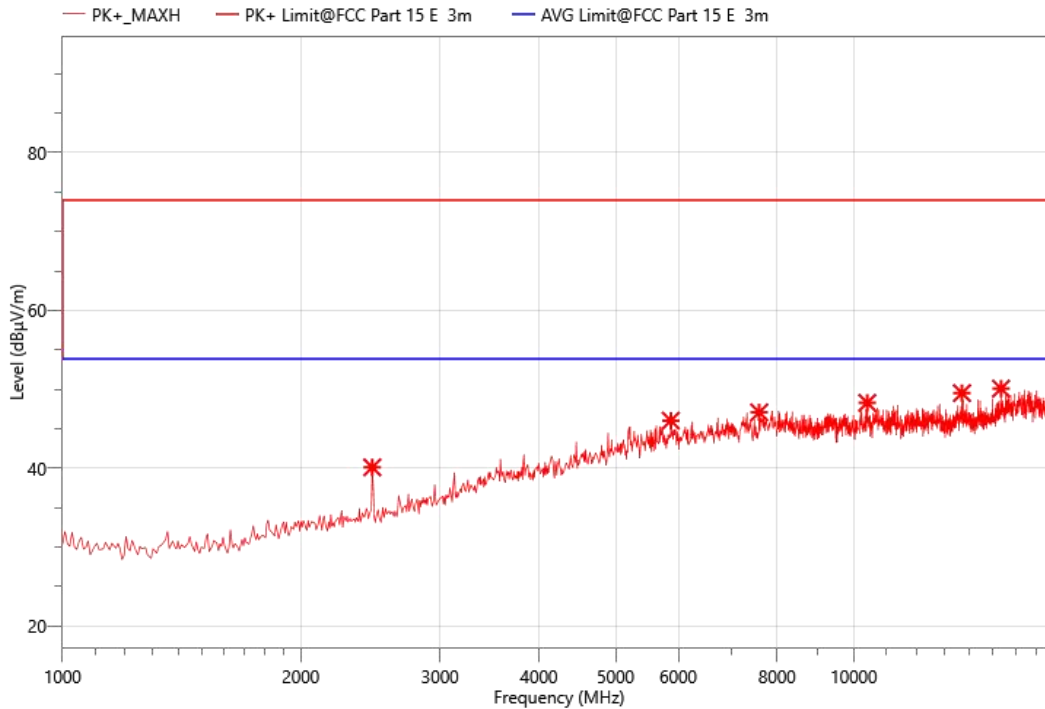

### Critical\_Freqs

No.	Freq. (MHz)	Reading (dBµV)	Meas. (dBµV/m)	Limit (dBµV/m)	Margin (dBµV/m)	Det.	Height (cm)	Pol.	Azimuth (deg)	Corr. (dB)
1	2463.000	60.46	40.09	74.00	33.91	PK+	150.0	H	360.0	-20.37
2	5872.000	51.22	46.02	74.00	27.98	PK+	150.0	H	360.0	-5.2
3	7594.000	49.88	47.07	74.00	26.93	PK+	150.0	H	360.0	-2.81
4	10400.000	48.39	48.28	74.00	25.72	PK+	150.0	H	360.0	-0.11
5	13700.000	47.20	49.51	74.00	24.49	PK+	150.0	H	360.0	2.31
6	15350.000	47.24	50.08	74.00	23.92	PK+	150.0	H	360.0	2.84

EUT :	Botslab Outdoor Dual-Lens Camera
MN:	W302
Mode:	A5200
Power:	DC5V
TE:	BIG
Date	2023/7/4
T/A/P	24.1°C/54%/101Kpa

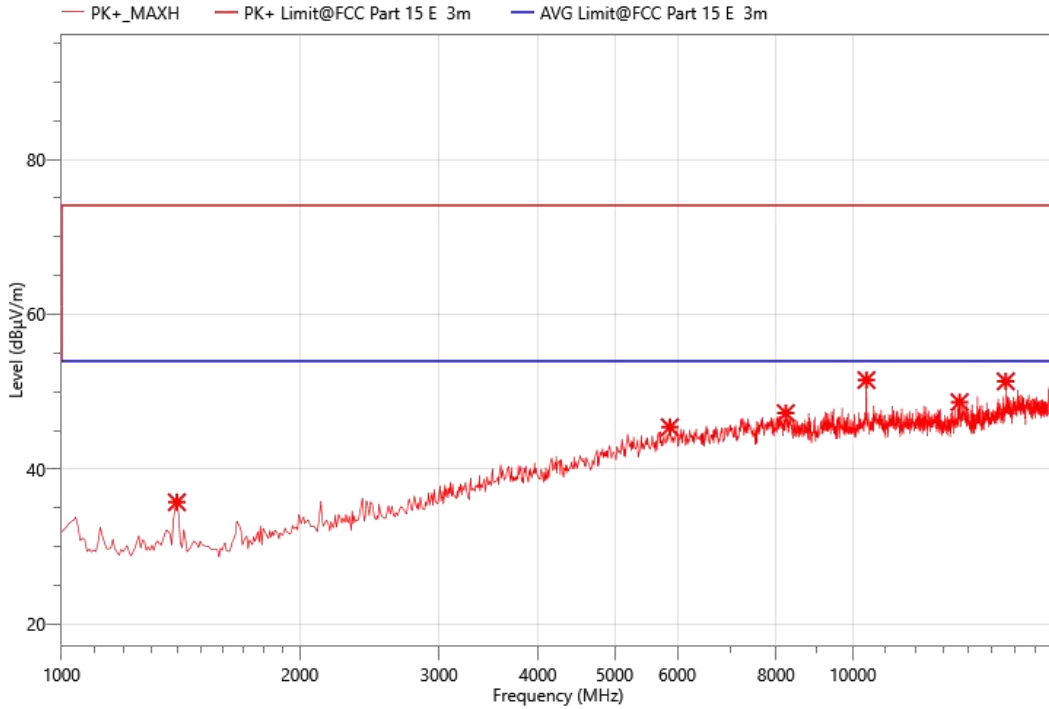

### Critical\_Freqs

No.	Freq. (MHz)	Reading (dBµV)	Meas. (dBµV/m)	Limit (dBµV/m)	Margin (dBµV/m)	Det.	Height (cm)	Pol.	Azimuth (deg)	Corr. (dB)
1	1399.000	61.78	35.75	74.00	38.25	PK+	150.0	V	360.0	-26.03
2	5872.000	50.63	45.43	74.00	28.57	PK+	150.0	V	360.0	-5.2
3	8230.000	48.27	47.25	74.00	26.75	PK+	150.0	V	360.0	-1.02
4	10405.000	51.63	51.52	74.00	22.48	PK+	150.0	V	360.0	-0.11
5	13645.000	47.37	48.66	74.00	25.34	PK+	150.0	V	360.0	1.29
6	15610.000	49.00	51.35	74.00	22.65	PK+	150.0	V	360.0	2.35

EUT :	Botslab Outdoor Dual-Lens Camera
MN:	W302
Mode:	A5240
Power:	DC5V
TE:	BIG
Date	2023/7/4
T/A/P	24.1°C/54%/101Kpa

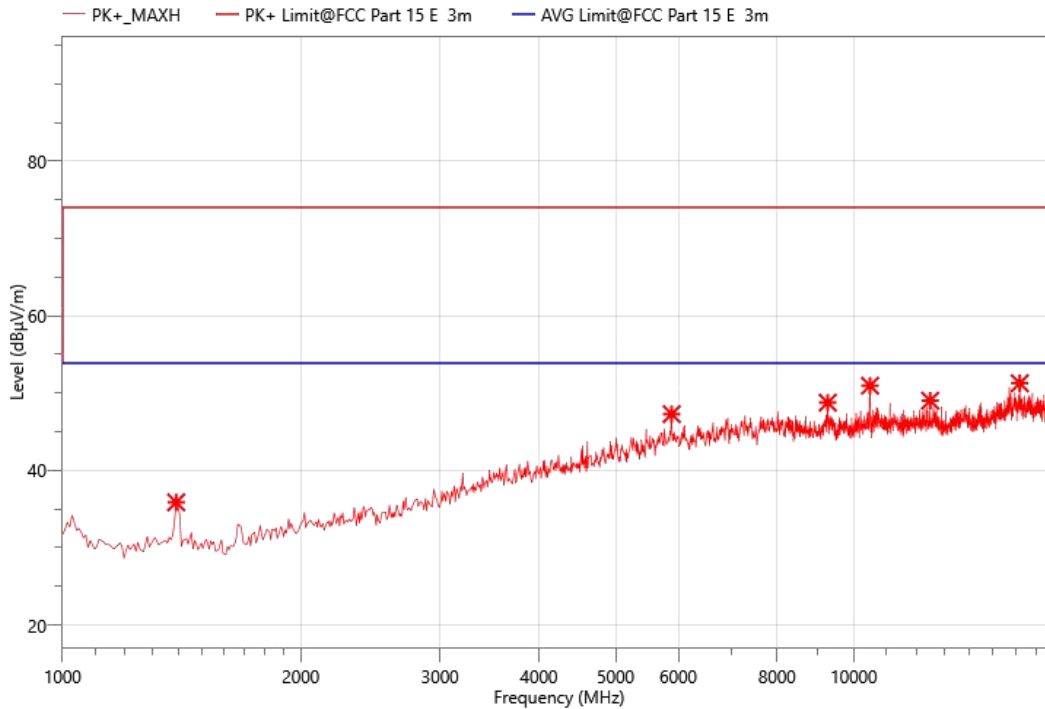

### Critical\_Freqs

No.	Freq. (MHz)	Reading (dBµV)	Meas. (dBµV/m)	Limit (dBµV/m)	Margin (dBµV/m)	Det.	Height (cm)	Pol.	Azimuth (deg)	Corr. (dB)
1	1392.000	61.91	35.88	74.00	38.12	PK+	150.0	V	360.0	-26.03
2	5886.000	52.33	47.29	74.00	26.71	PK+	150.0	V	360.0	-5.04
3	9270.000	49.79	48.77	74.00	25.23	PK+	150.0	V	360.0	-1.02
4	10485.000	51.67	50.96	74.00	23.04	PK+	150.0	V	360.0	-0.71
5	12490.000	48.49	49.03	74.00	24.97	PK+	150.0	V	360.0	0.54
6	16210.000	47.27	51.28	74.00	22.72	PK+	150.0	V	360.0	4.01

EUT :	Botslab Outdoor Dual-Lens Camera
MN:	W302
Mode:	A5240
Power:	DC5V
TE:	BIG
Date	2023/7/4
T/A/P	24.1°C/54%/101Kpa

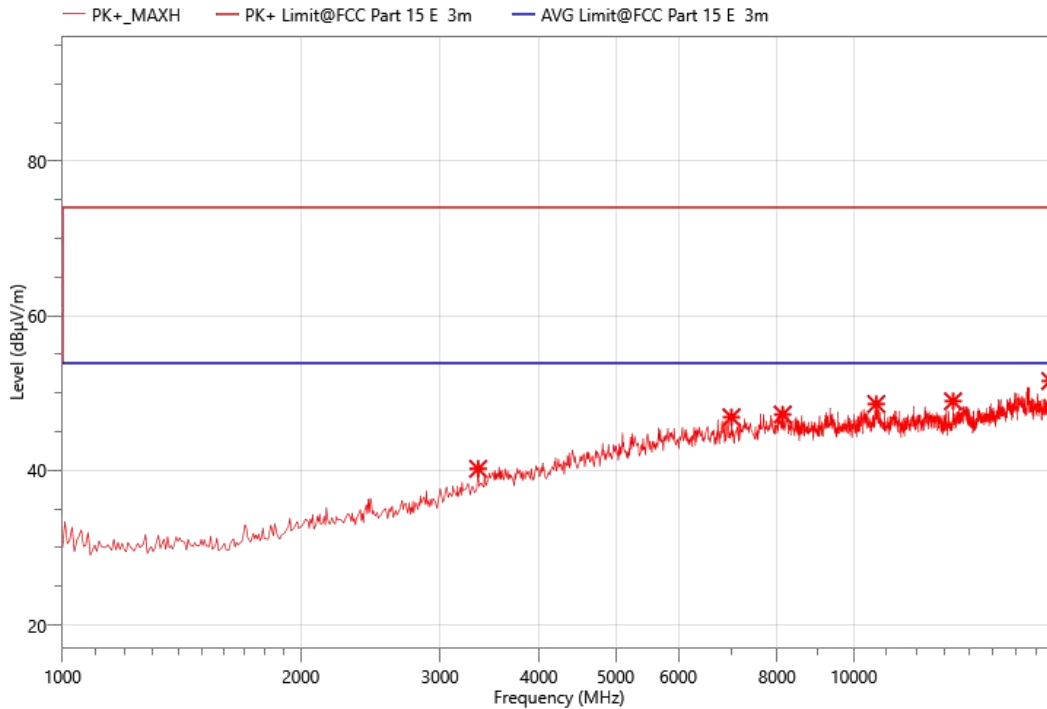

### Critical\_Freqs

No.	Freq. (MHz)	Reading (dBµV)	Meas. (dBµV/m)	Limit (dBµV/m)	Margin (dBµV/m)	Det.	Height (cm)	Pol.	Azimuth (deg)	Corr. (dB)
1	3352.000	55.56	40.21	74.00	33.79	PK+	150.0	H	360.0	-15.35
2	7006.000	49.89	46.88	74.00	27.12	PK+	150.0	H	360.0	-3.01
3	8130.000	49.20	47.24	74.00	26.76	PK+	150.0	H	360.0	-1.96
4	10675.000	48.21	48.59	74.00	25.41	PK+	150.0	H	360.0	0.38
5	13350.000	48.24	48.95	74.00	25.05	PK+	150.0	H	360.0	0.71
6	17715.000	47.37	51.57	74.00	22.43	PK+	150.0	H	360.0	4.2

**No others harmonics emissions are higher than 20 dB below the limits of 47 CFR Part 15.407.**

- Note: (1) All Readings are Peak Value (VBW=3MHz) and Peak Value (VBW=10Hz).
- (2) Emission Level= Reading Level+Probe Factor +Cable Loss.
- (3) EIRP[dBm] = E[dBµV/m] + 20 log[d[meters]] - 104.77  
d is the measurement distance in 3 meters

● Band Edge

EUT :	Botslab Outdoor Dual-Lens Camera
MN:	W302
Mode:	A5180
Power:	DC5V
TE:	BIG
Date	2023/7/4
T/A/P	24.1°C/54%/101Kpa

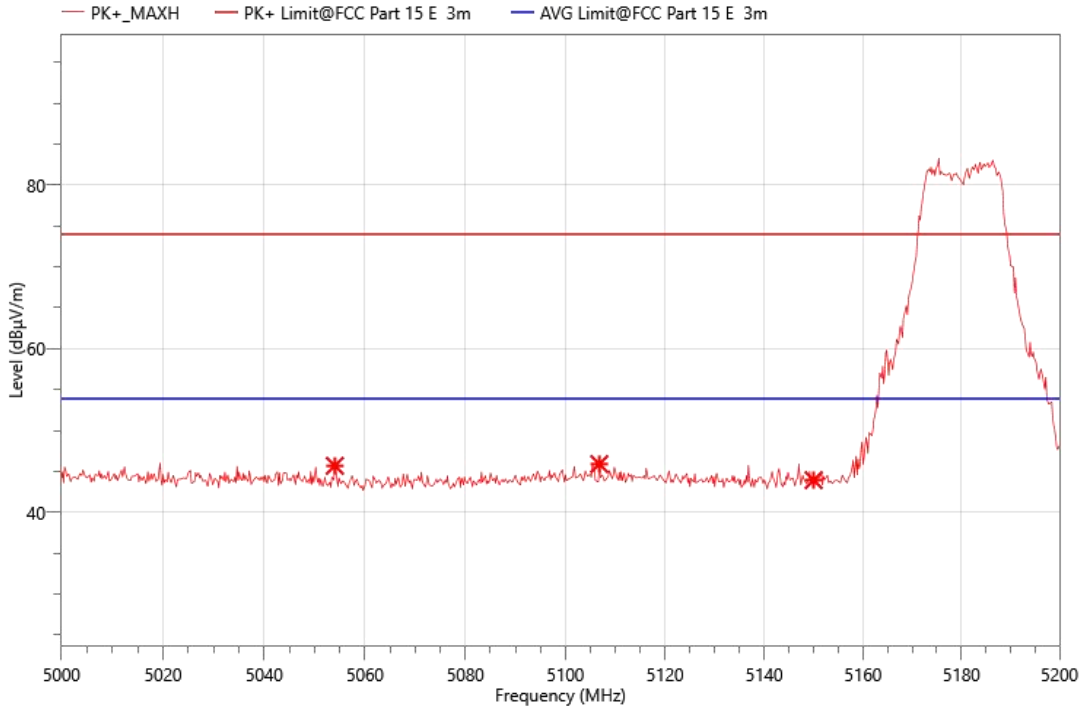

**Critical\_Freqs**

No.	Freq. (MHz)	Reading (dBµV)	Meas. (dBµV/m)	Limit (dBµV/m)	Margin (dBµV/m)	Det.	Height (cm)	Pol.	Azimuth (deg)	Corr. (dB)
1	5054.000	54.52	45.68	74.00	28.32	PK+	150.0	H	360.0	-8.84
2	5106.800	54.44	45.89	74.00	28.11	PK+	150.0	H	360.0	-8.55
3	5150.000	52.65	43.93	74.00	30.07	PK+	150.0	H	360.0	-8.72

EUT :	Botslab Outdoor Dual-Lens Camera
MN:	W302
Mode:	A5180
Power:	DC5V
TE:	BIG
Date	2023/7/4
T/A/P	24.1°C/54%/101Kpa

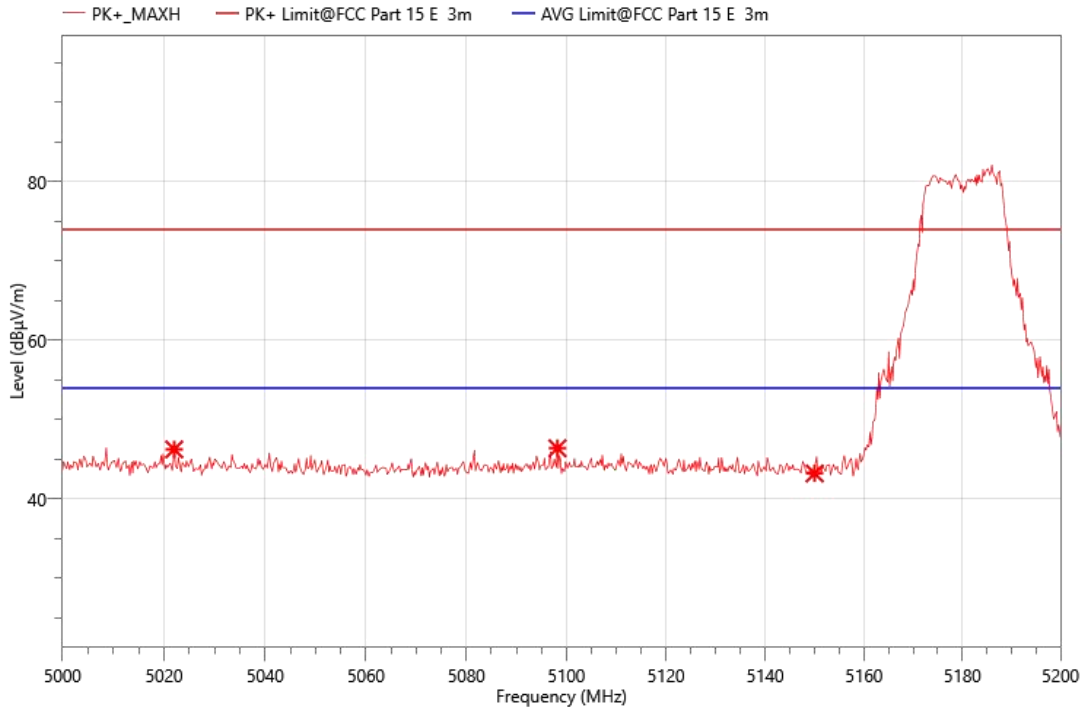

### Critical\_Freqs

No.	Freq. (MHz)	Reading (dBµV)	Meas. (dBµV/m)	Limit (dBµV/m)	Margin (dBµV/m)	Det.	Height (cm)	Pol.	Azimuth (deg)	Corr. (dB)
1	5022.000	54.92	46.25	74.00	27.75	PK+	150.0	V	249.2	-8.67
2	5098.200	54.91	46.40	74.00	27.60	PK+	150.0	V	249.2	-8.51
3	5150.000	51.94	43.22	74.00	30.78	PK+	150.0	V	249.2	-8.72

EUT :	Botslab Outdoor Dual-Lens Camera
MN:	W302
Mode:	A5320
Power:	DC5V
TE:	BIG
Date	2023/7/4
T/A/P	24.1°C/54%/101Kpa

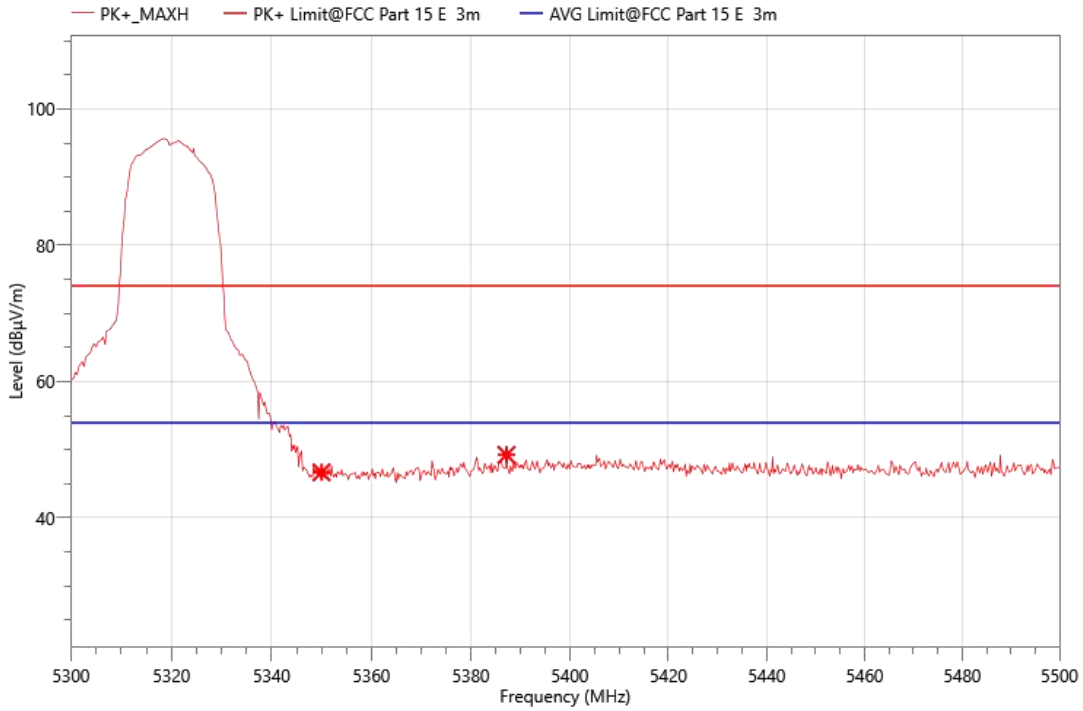

### Critical\_Freqs

No.	Freq. (MHz)	Reading (dBµV)	Meas. (dBµV/m)	Limit (dBµV/m)	Margin (dBµV/m)	Det.	Height (cm)	Pol.	Azimuth (deg)	Corr. (dB)
1	5350.000	54.29	46.67	74.00	27.33	PK+	150.0	H	360.0	-7.62
2	5387.200	56.73	49.24	74.00	24.76	PK+	150.0	H	360.0	-7.49

EUT :	Botslab Outdoor Dual-Lens Camera
MN:	W302
Mode:	A5320
Power:	DC5V
TE:	BIG
Date	2023/7/4
T/A/P	24.1°C/54%/101Kpa

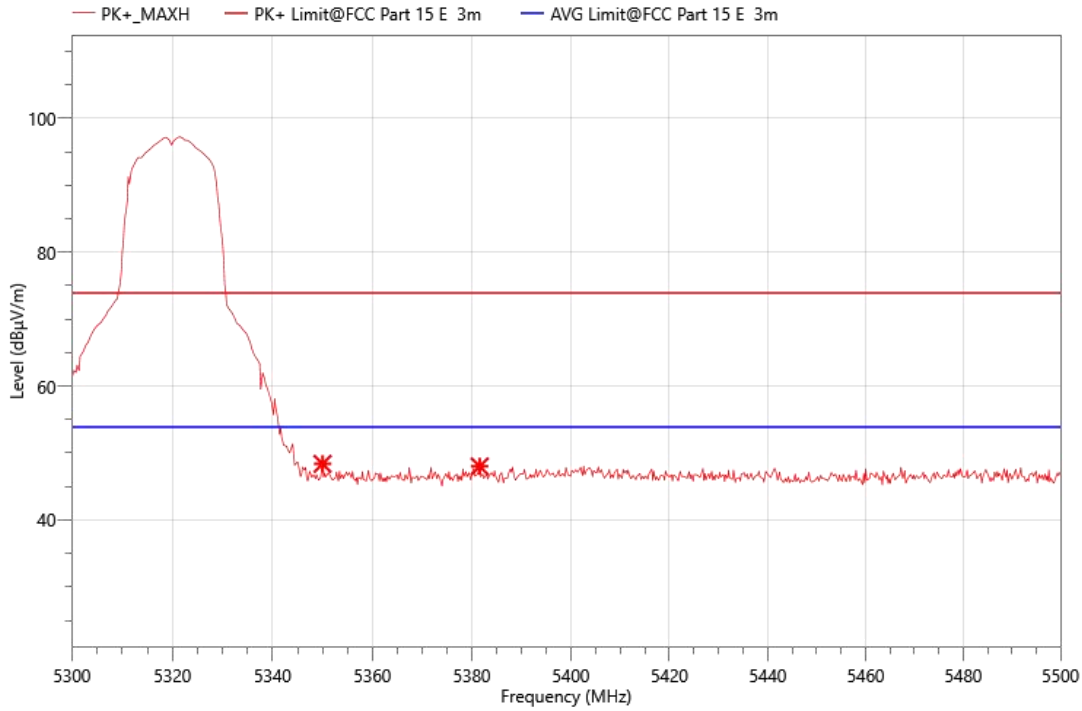

### Critical\_Freqs

No.	Freq. (MHz)	Reading (dBµV)	Meas. (dBµV/m)	Limit (dBµV/m)	Margin (dBµV/m)	Det.	Height (cm)	Pol.	Azimuth (deg)	Corr. (dB)
1	5350.000	56.01	48.39	74.00	25.61	PK+	150.0	V	360.0	-7.62
2	5381.600	55.48	48.01	74.00	25.99	PK+	150.0	V	360.0	-7.47



EUT :	Botslab Outdoor Dual-Lens Camera
MN:	W302
Mode:	A5500
Power:	DC5V
TE:	BIG
Date	2023/7/4
T/A/P	24.1°C/54%/101Kpa

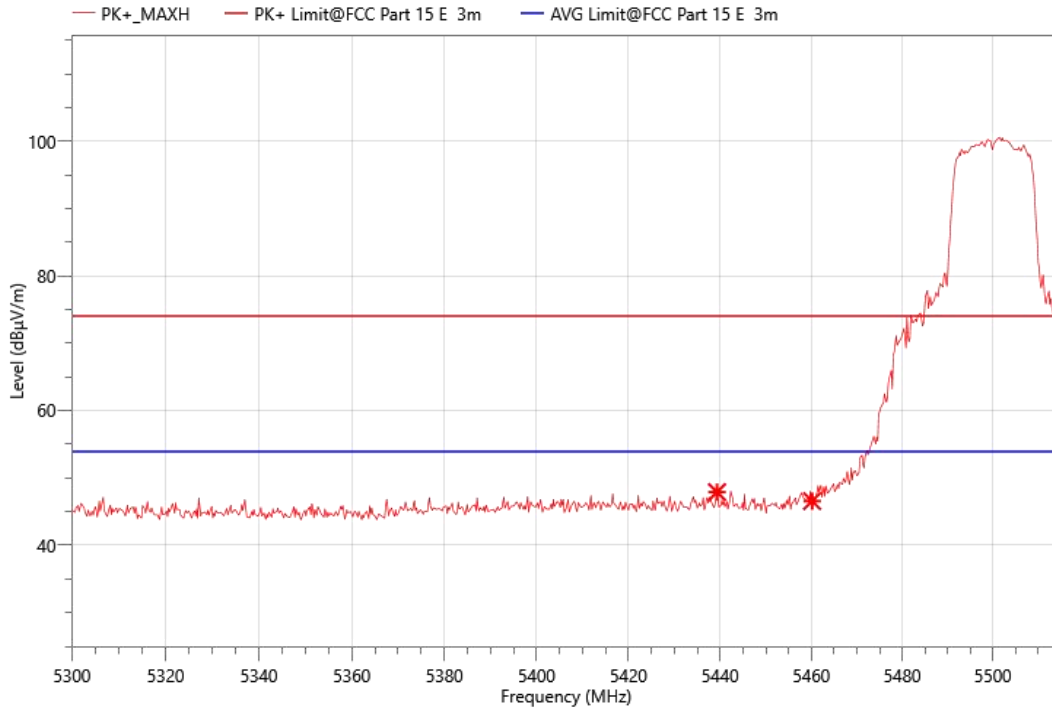

### Critical\_Freqs

No.	Freq. (MHz)	Reading (dBµV)	Meas. (dBµV/m)	Limit (dBµV/m)	Margin (dBµV/m)	Det.	Height (cm)	Pol.	Azimuth (deg)	Corr. (dB)
1	5439.320	55.46	47.87	74.00	26.13	PK+	150.0	H	360.0	-7.59
2	5460.175	54.37	46.54	74.00	27.46	PK+	150.0	H	360.0	-7.83

EUT :	Botslab Outdoor Dual-Lens Camera
MN:	W302
Mode:	A5500
Power:	DC5V
TE:	BIG
Date	2023/7/4
T/A/P	24.1°C/54%/101Kpa

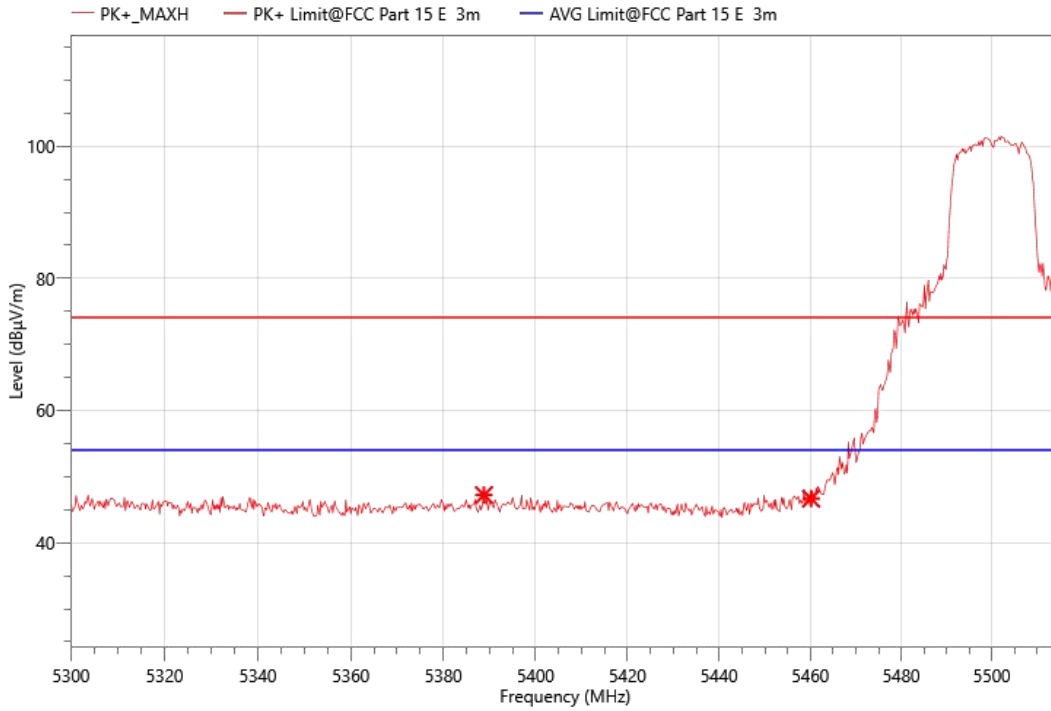

### Critical\_Freqs

No.	Freq. (MHz)	Reading (dBµV)	Meas. (dBµV/m)	Limit (dBµV/m)	Margin (dBµV/m)	Det.	Height (cm)	Pol.	Azimuth (deg)	Corr. (dB)
1	5388.795	54.70	47.21	74.00	26.79	PK+	150.0	V	360.0	-7.49
2	5460.175	54.49	46.66	74.00	27.34	PK+	150.0	V	360.0	-7.83

EUT :	Botslab Outdoor Dual-Lens Camera
MN:	W302
Mode:	A5825
Power:	DC5V
TE:	BIG
Date	2023/7/4
T/A/P	24.1°C/54%/101Kpa

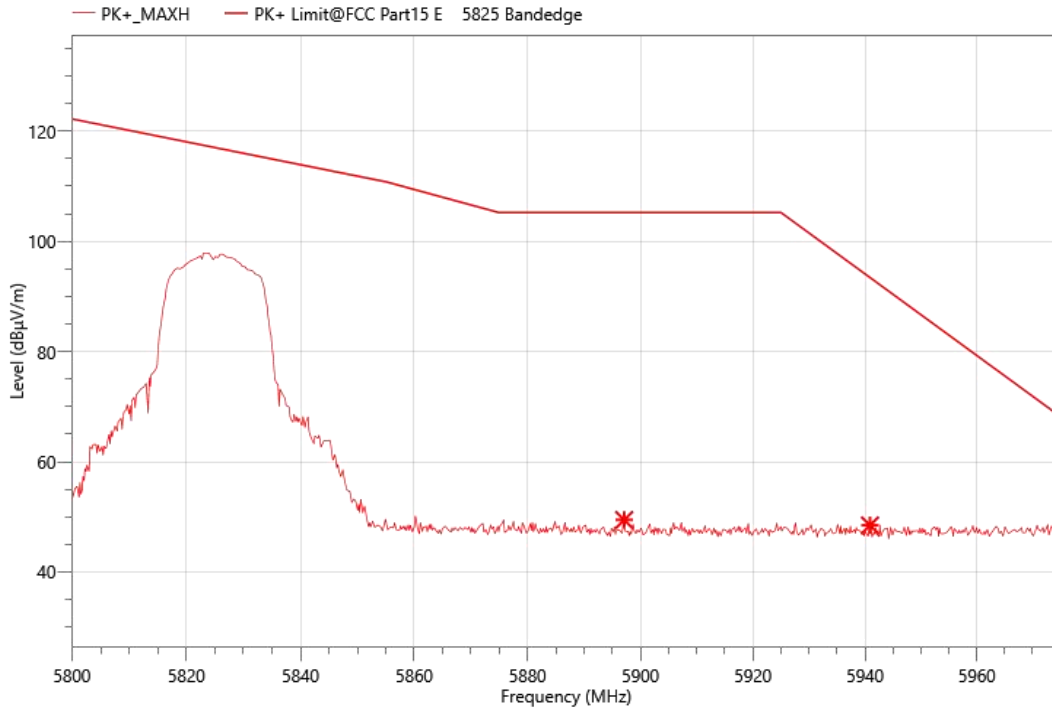

### Critical\_Freqs

No.	Freq. (MHz)	Reading (dBµV)	Meas. (dBµV/m)	Limit (dBµV/m)	Margin (dBµV/m)	Det.	Height (cm)	Pol.	Azimuth (deg)	Corr. (dB)
1	5897.125	55.50	49.45	105.20	55.75	PK+	150.0	V	360.0	-6.05
2	5940.875	54.39	48.47	93.42	44.95	PK+	150.0	V	360.0	-5.92

EUT :	Botslab Outdoor Dual-Lens Camera
MN:	W302
Mode:	A5825
Power:	DC5V
TE:	BIG
Date	2023/7/4
T/A/P	24.1°C/54%/101Kpa

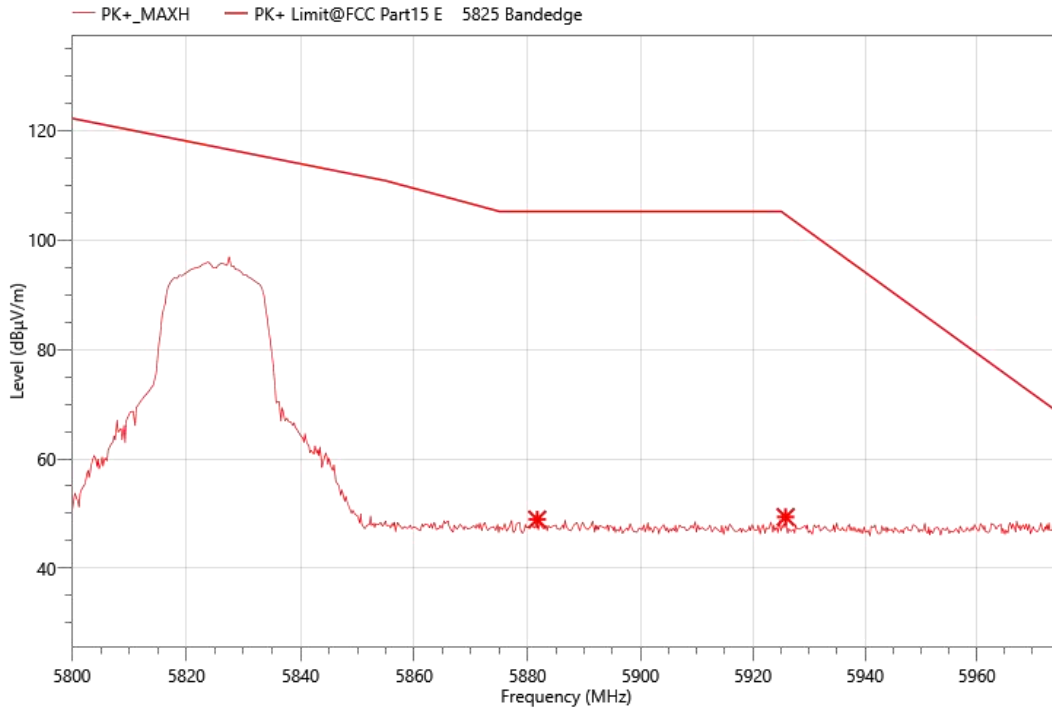

### Critical\_Freqs

No.	Freq. (MHz)	Reading (dBµV)	Meas. (dBµV/m)	Limit (dBµV/m)	Margin (dBµV/m)	Det.	Height (cm)	Pol.	Azimuth (deg)	Corr. (dB)
1	5881.725	55.06	48.92	105.20	56.28	PK+	150.0	H	360.0	-6.14
2	5925.825	55.18	49.38	104.59	55.21	PK+	150.0	H	360.0	-5.8

Note: 1. 802.11a, 802.11n (HT-20), 802.11n (HT-40), 802.11ac (VHT-20), 802.11ax (HE-20), 802.11ac (VHT-40), 802.11ax (HE-40) all has been tested, the worst case is 802.11a, only shown the worst case.

## 9. AC POWER LINE CONDUCTED EMISSION

### LIMITS

Please refer to CFR 47 FCC §15.207 (a) and ISED RSS-Gen Clause 8.8

FREQUENCY (MHz)	Quasi-peak	Average
0.15 -0.5	66 - 56 *	56 - 46 *
0.50 -5.0	56.00	46.00
5.0 -30.0	60.00	50.00

### TEST PROCEDURE

Refer to ANSI C63.10-2013 clause 6.2.

The EUT is put on a table of non-conducting material that is 80 cm high. The vertical conducting wall of shielding is located 40 cm to the rear of the EUT. The power line of the EUT is connected to the AC mains through a Artificial Mains Network (A.M.N.). A EMI Measurement Receiver (R&S Test Receiver ESR3) is used to test the emissions from both sides of AC line. According to the requirements in Section 6.2 of ANSI C63.10-2013. Conducted emissions from the EUT measured in the frequency range between 0.15 MHz and 30 MHz using CISPR Quasi-Peak and average detector mode. The bandwidth of EMI test receiver is set at 9 kHz.

The arrangement of the equipment is installed to meet the standards and operating in a manner, which tends to maximize its emission characteristics in a normal application.

### TEST ENVIRONMENT

Temperature	26°C	Relative Humidity	54.3%
Atmosphere Pressure	101kPa		

### TEST RESULTS

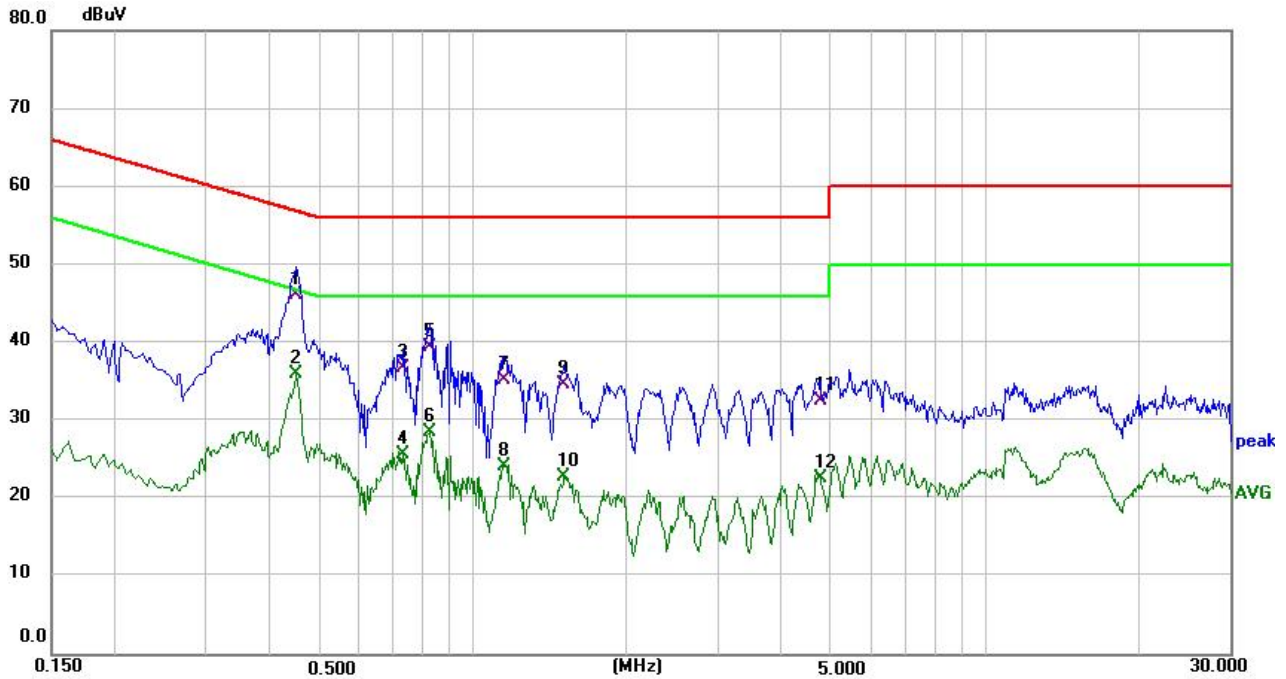

<b>Site:</b>		<b>Phase:</b> L1	<b>Temperature(C):</b> 26(C)
<b>Limit:</b>	FCC Part 15 C Conduction(QP)	<b>Test Time:</b>	<b>Humidity(%):</b> 54.3%
<b>EUT:</b>	Botslab Outdoor Dual-Lens Camera	<b>Power Rating:</b>	<b>2023/6/15 21:08:24</b>
<b>M/N.:</b>	W302	<b>Test Engineer:</b>	Jayce
<b>Mode:</b>	5GHz WIFI Band1 A		
<b>Note:</b>			

No.	Frequency (MHz)	Reading Level(dBuV)	Factor (dB)	Measurement(dBuV)	Limit (dBuV)	Margin (dB)	Detector	Comment
1 *	0.4500	35.63	10.47	46.10	56.88	-10.78	QP	
2	0.4500	25.48	10.47	35.95	46.88	-10.93	AVG	
3	0.7300	25.75	11.05	36.80	56.00	-19.20	QP	
4	0.7300	14.72	11.05	25.77	46.00	-20.23	AVG	
5	0.8220	29.81	9.59	39.40	56.00	-16.60	QP	
6	0.8220	18.89	9.59	28.48	46.00	-17.52	AVG	
7	1.1500	25.59	9.61	35.20	56.00	-20.80	QP	
8	1.1500	14.50	9.61	24.11	46.00	-21.89	AVG	
9	1.5100	25.08	9.62	34.70	56.00	-21.30	QP	
10	1.5100	13.22	9.62	22.84	46.00	-23.16	AVG	
11	4.7500	22.81	9.69	32.50	56.00	-23.50	QP	
12	4.7500	12.86	9.69	22.55	46.00	-23.45	AVG	

\*:Maximum data x:Over limit !:over margin

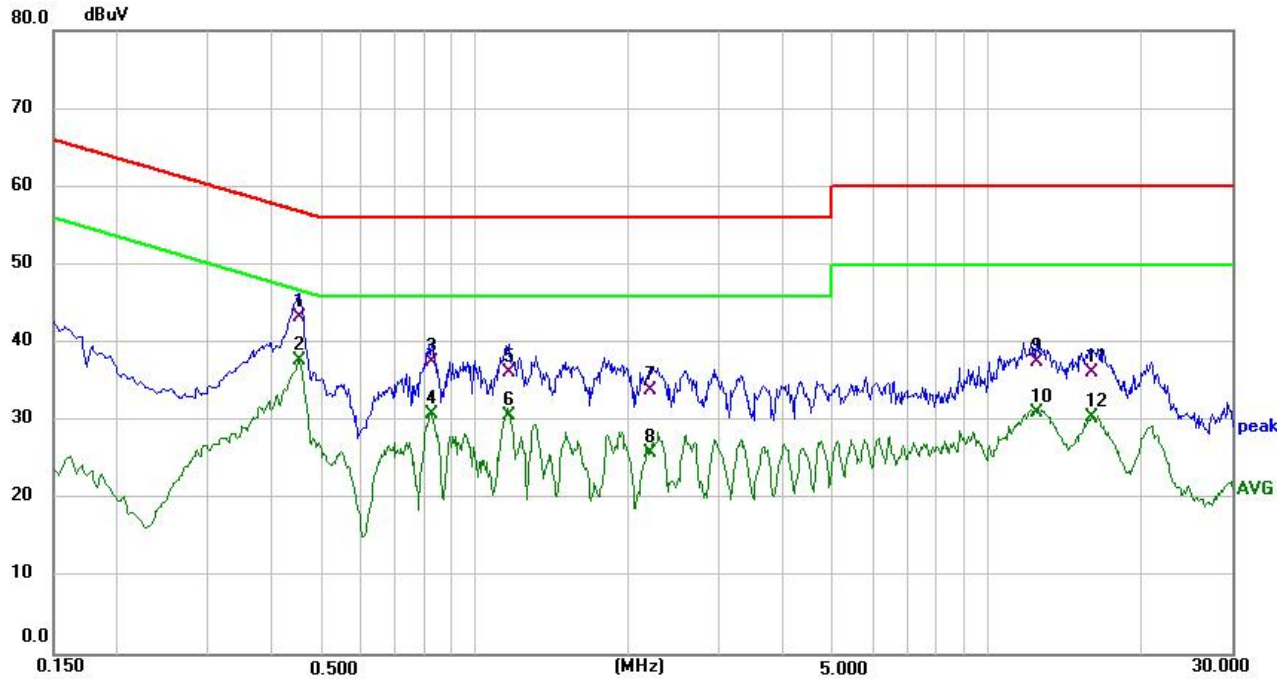

<b>Site:</b>		<b>Phase:</b> N	<b>Temperature(C):</b> 26(C)
<b>Limit:</b>	FCC Part 15 C Conduction(QP)	<b>Test Time:</b>	<b>Humidity(%):</b> 54.3%
<b>EUT:</b>	Botslab Outdoor Dual-Lens Camera	<b>Power Rating:</b>	<b>AC 120V/60Hz</b>
<b>M/N.:</b>	W302	<b>Test Engineer:</b>	<b>Jayce</b>
<b>Mode:</b>	5GHz WIFI Band1 A		
<b>Note:</b>			

No.	Frequency (MHz)	Reading Level(dBuV)	Factor (dB)	Measurement(dBuV)	Limit (dBuV)	Margin (dB)	Detector	Comment
1	0.4540	32.73	10.47	43.20	56.80	-13.60	QP	
2 *	0.4540	27.27	10.47	37.74	46.80	-9.06	AVG	
3	0.8220	27.91	9.59	37.50	56.00	-18.50	QP	
4	0.8220	21.33	9.59	30.92	46.00	-15.08	AVG	
5	1.1620	26.49	9.61	36.10	56.00	-19.90	QP	
6	1.1620	21.08	9.61	30.69	46.00	-15.31	AVG	
7	2.1940	24.17	9.63	33.80	56.00	-22.20	QP	
8	2.1940	16.26	9.63	25.89	46.00	-20.11	AVG	
9	12.4700	27.60	10.00	37.60	60.00	-22.40	QP	
10	12.4700	21.09	10.00	31.09	50.00	-18.91	AVG	
11	16.0220	26.00	10.10	36.10	60.00	-23.90	QP	
12	16.0220	20.28	10.10	30.38	50.00	-19.62	AVG	

\*:Maximum data x:Over limit !:over margin

## 10. ANTENNA REQUIREMENT

### REQUIREMENT

Standard	Requirement
FCC CRF Part 15.203 RSS-Gen issue 5 6.8.	An intentional radiator shall be designed to ensure that no antenna other than that furnished by the responsible party shall be used with the device. The use of a permanently attached antenna or of an antenna that uses a unique coupling to the intentional radiator shall be considered sufficient to comply with the provisions of this section. The manufacturer may design the unit so that a broken antenna can be replaced by the user, but the use of a standard antenna Sunshine or electrical connector is prohibited. This requirement does not apply to carrier current devices or to devices operated under the provisions of §15.211, §15.213, §15.217, §15.219, or §15.221. Further, this requirement does not apply to intentional radiators that must be professionally installed, such as perimeter protection systems and some field disturbance sensors, or to other intentional radiators which, in accordance with §15.31(d), must be measured at the installation site. However, the installer shall be responsible for ensuring that the proper antenna is employed so that the limits in this part are not exceeded.

For intentional device, according to FCC 47 CFR Section 15.203, RSS-Gen issue 5 6.8. an intentional radiator shall be designed to ensure that no antenna other than that furnished by the responsible party shall be used with the device. And according to FCC 47 CFR Section 15.407 (a), if transmitting antennas of directional gain greater than 6dBi are used, the power shall be reduced by the amount in dB that the directional gain of the antenna exceeds 6dBi.

### DESCRIPTION

Pass



## **11. TEST DATA**

Please refer to section "Test Data" - Appendix C1~C4

## **APPENDIX: PHOTOGRAPHS OF TEST CONFIGURATION**

Please refer to test report: E01A23040871F00101

## **APPENDIX: PHOTOGRAPHS OF THE EUT**

Please refer to test report: E01A23040871F00101

**END OF REPORT**