

Botslab

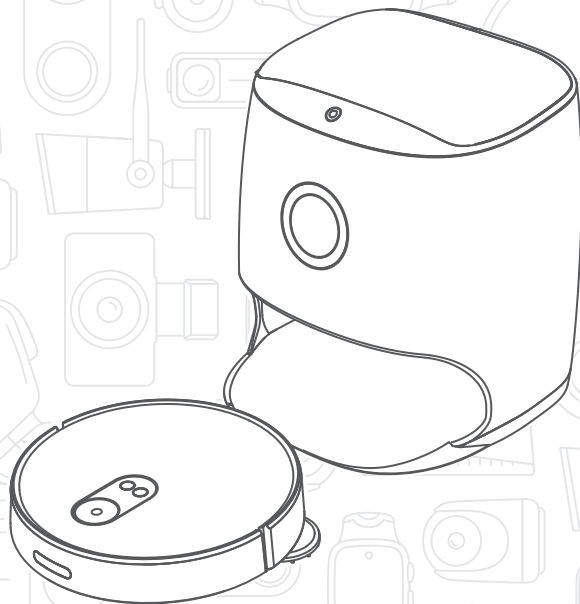

Botslab Robot Mop M20

User Manual

Dear customers

Thank you for choosing the artificially intelligent (AI) Botslab Robot Mop! Please read the user manual carefully before using and keep this manual for future reference.

Contents

en English	P01 – P10
ru Русский	P11 – P20
de Deutsch	P21 – P29
fr Français	P30 – P38
sp Español	P39 – P47
it Italiano	P48 – P56
kr 한국어	P57 – P65
ja 日本語	P66 – P74
pl Polski	P74 – P83
cz čeština	P84 – P92
tr Türkçe	P93 – P101
hr Hrvatski	

If you have questions or comments about your Robot, please do not hesitate to contact us:

Customer service email: service@botslab.com

Or reach us via Facebook group: [@botslabofficial](https://www.facebook.com/botslabofficial)

Safety Information

- **Before using the product, please read the entire safety instructions and save the manual for future reference. Any operations that do not follow the manual may cause serious injury or damage.**
- **WARNING**
 - This appliance can be used by children aged from 8 years and above and persons with reduced physical, sensory or mental capabilities or lack of experience and knowledge if they have been given supervision or instruction concerning use of the appliance in a safe way and understand the hazards involved. Children shall not play with the appliance. Cleaning and user maintenance shall not be made by children without supervision.
 - Small children and pets should be supervised when the robot is operating.
 - This product can only be used with the authorized adapter, power supply cord, plug, battery, and self-cleaning base. Use of any unauthorized accessories may cause the product to generate heat, smoke, catch fire, or explode.
 - Stop using the product if the Robot or any accessory is damaged. Please contact Botslab Customer Service to purchase or replace. Except for the repair technicians designated or authorized by Botslab, no one shall disassemble, repair, or modify this product.
 - Do not place objects (including children and pets) on the robot at any time.
 - Only use and store this product indoors in dry location with a temperature from 0°C/32°F to 40°C/104°F.
 - Always disconnect your Robot from the self-cleaning base before cleaning or maintaining it.
 - Do not handle your Robot or self-cleaning base with wet hands or wipe the product with a wet cloth .
 - Do not wash the Robot or self-cleaning base under running water.
 - To ensure safe operation, do not use the product in a suspended area (such as a second floor loft, open balcony, and tops of furniture) without a physical barrier.
 - Ensure the dirt disposal base is placed at least 1.5 meters/4.9 feet away from stairs, other open areas, and heat sources (such as heaters).
 - Do not short-circuit the battery by allowing metal objects to contact battery terminals or immerse in liquid. Do not subject batteries to mechanical shock.
 - Periodically inspect the battery pack for any sign of damage or leakage. Do not charge damaged or leaking battery packs, do not allow the liquid to come in contact with skin or eyes. If a contact has been made, wash the affected area with copious amounts of water and seek medical advice.
 - For the purposes of recharging the battery, only use the detachable supply unit provided with this appliance.
 - This appliance contains batteries that are only replaceable by skilled person.
- **CAUTION**
 - This product is used for floor cleaning in a home environment. Do not use it for outdoor (such as an open balcony), non-ground (such as a sofa), commercial, or industrial environments.
 - Before using the product, pull cords for blinds or curtains, power cords to prevent them from obstructing the product.
 - Remove fragile objects (such as vases) on the floor to prevent the robot from damaging valuables.
 - Do not put detergent, disinfectants, perfume, or other chemicals in the water tank.

- Do not let hair, fingers, or any other body parts near mop bracket when the robot is operating.
- Do not use this product to clean sharp objects (such as decoration debris, glass, and iron nails).
- Do not use this product to clean burning or smoking objects (such as undistinguished cigarette butts).

• NOTICE

- Do not use the product in a room where infants or young children are sleeping.
- Do not use the bumper or top cover as handles to carry the robot.
- Do not use the mopping function on carpets or the tops of furnitures.
- Using Robot in an environment with direct sunlight or strong reflective objects may affect the cleaning effect.
- After unpacking, you may discover water stains or residual water drops on the product's water tank or water outlets, which is due to the specialized water tank test employed in the factory before delivery and is a normal occurrence. This will not affect product usage.
- If you need to transport this product, please ensure that the Robot is turned off. It is recommended to use the original packaging for transportation.
- If you will not use this product for a long period of time, turn off the robot after it is fully charged and put the product in a cool and dry place. Charge the Robot at least once every three months to avoid over-discharge from the battery.
- If you live in an area prone to electrical storms, it is recommended that you use additional surge protection. Your self-cleaning base may be protected with a surge protector in the event of severe electrical storms.
- Please use this product in accordance with the manual. Liabilities for any loss or injury caused by improper use shall be solely borne by the user.

• RECYCLING AND DISPOSAL

- Disconnect the product from the self-cleaning base, turn it off, and remove the battery before recycling or disposal.
- Place the battery in a sealed plastic bag and recycle or dispose of it safely according to local environmental regulations.
- It is strictly prohibited to burn the product even if the product is severely damaged.

Laser safety information

- All laser sensors meet the class 1 laser product standard of IEC60825 and does not produce dangerous laser radiation.
- Execution standard: IEC60335

California residents



WARNING: Cancer and Reproductive Harm – www.P65Warnings.ca.gov

Due to California's Proposition 65 Law, a warning must be posted on all products that may be sold into California. The warning does not mean that our products actually will cause any harm.

Product Overview

Specifications

Robot	
Dimensions	340 x 340 x 79 mm 13.4 x 13.4 x 3.1 inches
Product weight	X.XX±0.1 kg X.XX±0.22 lbs
Battery capacity	3200 mAh
Rated voltage	14.4 V
Rated power	30 W

Self-cleaning Base	
Dimensions	410 x 390 x 445 mm 16.1 x 15.4 x 17.5 inches
Rated power	48 W
Rated output	24 V $\overline{\text{---}}$ 2 A

Box Content
Robot, self-cleaning base, water tanks, mop brackets, mop pads, cleaning tool with holder, power cable, user manual

Button Functions

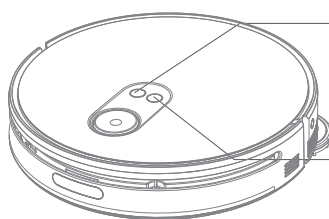

Charge Button

- Press: start/pause recharging;
- Press for 3s: start cleaning the 2m*2m square area centered on the robot.



CLEAN/Power Button

- Press: start/pause cleaning;
- Press for 3s: turn ON/OFF.

Press  +  at the same time for 3s:

- Start network configuration;
- Turn off parental controls.

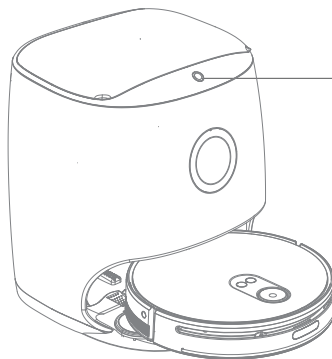

Base Button

- Press: start mopping when the robot is docked.
- Press for 2s: the robot will exit the base, and the base will start self-cleaning (long press again within 30 seconds to terminate self-cleaning).

Key Components

Robot

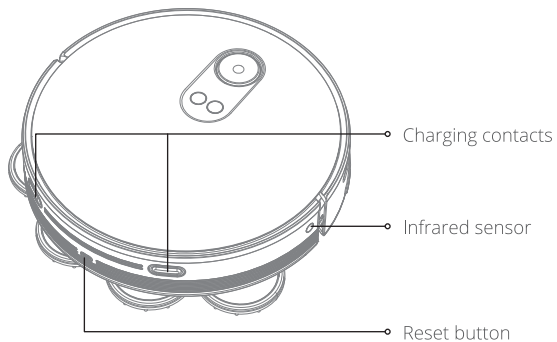
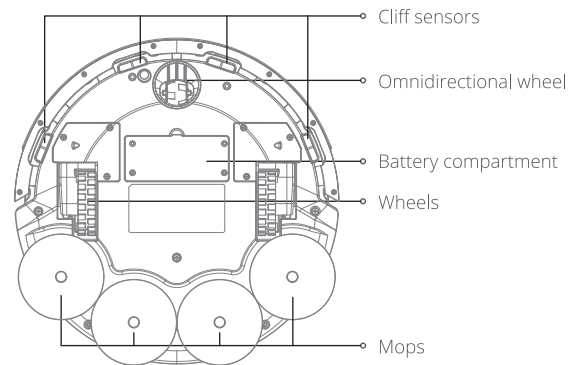
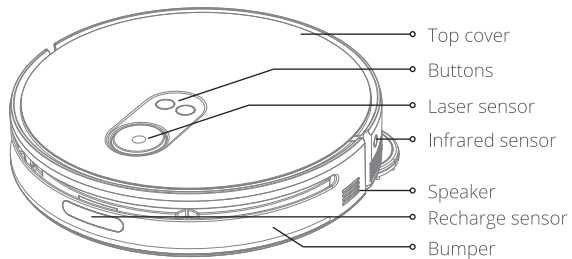

Self-cleaning Base

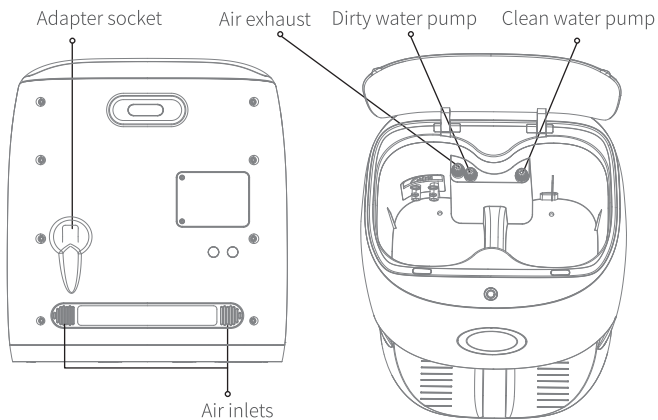
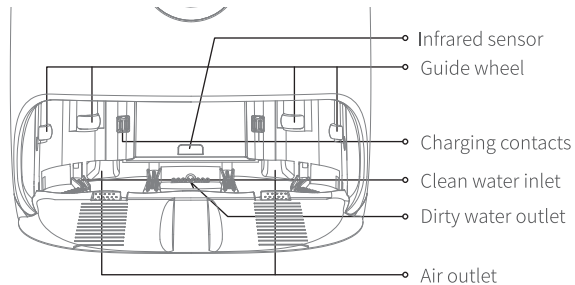
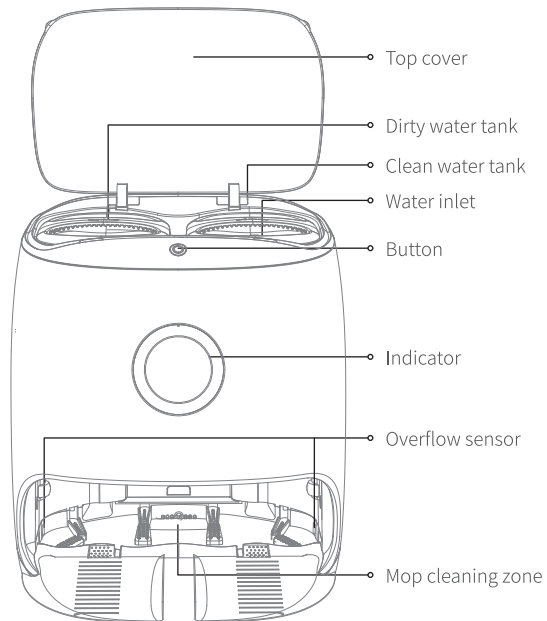

Installation Instructions

1. Install the mop brackets

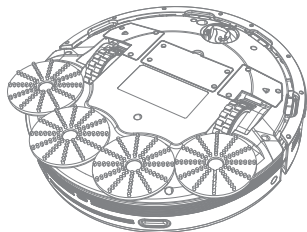

2. Connect the power supply

- Take the power cord out of the accessory box and connect it to the jack on the back of the base station and a power outlet.
- Organize the extra cable to prevent it from being stretched by the robot while cleaning.

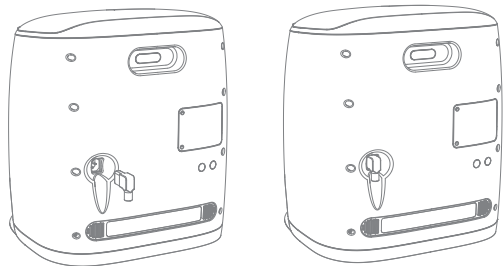

3. Place the base on the horizontal hard floor

- Leave 1 m (3.3 ft) on both sides and 1.5 m (4.9 ft) in the front of the base, and make sure there is no objects or strong light within this area.
- Ensure the base is placed at least 1.5 m (4.9 ft) away from stairs, other open areas and heat sources (such as heaters).
- Do not put the base on carpets.
- Do not move it frequently. If the base is moved, the robot may fail to locate itself or remove the current map. In this case, the map information (no-go zones, room names, etc.) may lose. The robot will create and save a new map during the next cleaning.

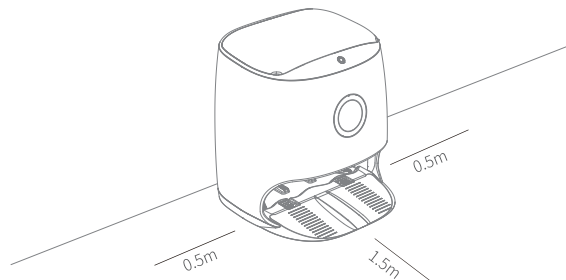

Using Instructions

1. Power on and charging

- Attach the robot to the self-cleaning base and align their charging contacts. The robot will automatically power on and start charging.

2. Fill up the clean water tank

- Fill the clean water tank with water, and the amount of water should not exceed the MAX mark. Please fasten the water tank lid and lift it up to avoid water splashing. Correctly place the water tank in the base.

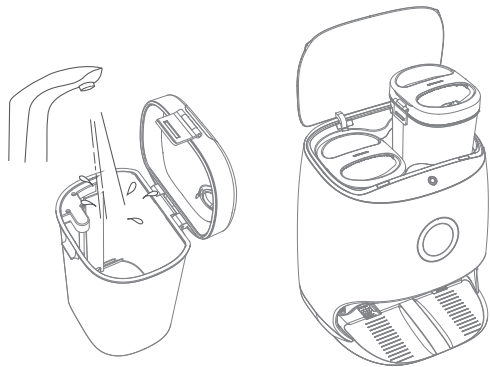

3. Download the mobile phone App

Method 1: Search for "Botslab" in Google Play or App Store and download it.

Q Botslab



Botslab

Method 2: Scan the QR code below by using mobile phone camera or any QR code scanner App to download the Botslab App.



4. Add your Robot on the App

- Please refer to the network configuration instruction in the box to let the App find your Robot.
- Then follow the instructions on the App step by step to bind the Robot to your account.

Note:

- Please check out further operation instructions on the App and do not hesitate to contact us if you have any questions or comments.

5. Start cleaning

Method 1: Press the  button on the base.

Method 2: Press the  button on the robot.

Method 3: Control via mobile app.

- Before using it for the first time, please open the doors of each room to help the robot explore the entire space and build a map. The robot will not mop during mapping.
- Please do not follow the robot when building the map, and please do not stand in narrow places or doorways, otherwise it may cause part of the map to be missing.
- After cleaning, please clean the dirty water tank in time to avoid odor.

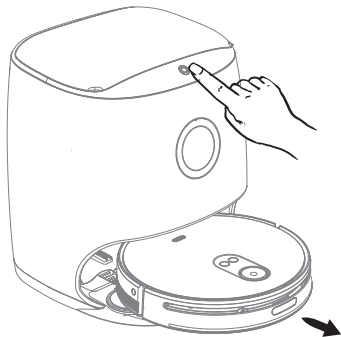

Note:

- The robot cannot be turned on when the battery is insufficient, and it will automatically turn on when it starts charging.
- The robot will automatically recharge when the power is lower than 20%, and return to the previous position to continue cleaning after charging is complete.
- When the robot is suspended for more than 1 hour, it will enter sleep mode. If the pause exceeds 12 hours or the battery level drops below 10%, the robot will shut down.
- The robot can only start cleaning when the battery is above 30%.

Indicator Status

Robot

- Solid blue: the robot is working normally;
- Blinking blue: The robot is offline;
- Flashing blue: the robot is pairing;
- Breathing blue: the robot is charging;
- Solid red: low power;
- Flashing red: the robot ran out of power.

Self-cleaning Base

- Solid blue: the robot is working normally;
- Breathing blue: self-cleaning;
- Blinking red: During the self-cleaning process, the clean/dirty water tank is not in place, the clean water tank is short of water, or the dirty water tank is full;
- Turns off: The robot has no cleaning task and stays at the base for more than 2 minutes.

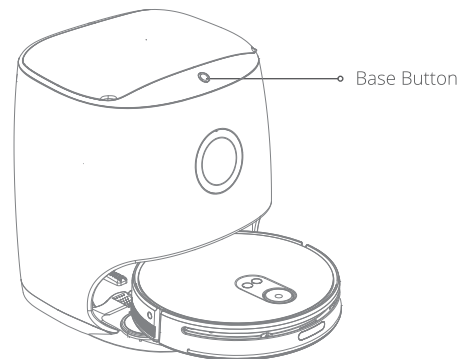
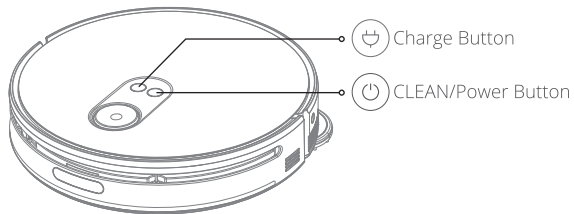

After-sales Service

Warranty Content

Name	Warranty Content	Warranty Period
Main unit	Robot (includes build-in battery)	1 year
Accessories	Self-cleaning base, power cable	1 year
Consumables	Water tanks, mop brackets, mop pads, cleaning tool with holder	/

❗ Warranty may vary between countries, please refer to the local laws and seller's information.

Exclusions and Limitations

- 1.The product is repaired without permission, wrongly used, crashed, neglected, misused, gotten wet, or damaged in an accident, modified, unauthorized accessories are used.
- 2.Warranty period expires.
- 3.Damage is caused by force majeure.
- 4.Defects of product and accessories caused by the owner or user.

Contact Us

Official site: www.botslab.com

Customer service: service@botslab.com



@Botslabofficial

FCC Statement

1. This device complies with Part 15 of the FCC Rules. Operation is subject to the following two conditions:

- (1) This device may not cause harmful interference, and
 - (2) This device must accept any interference received, including interference that may cause undesired operation.
2. any Changes or modifications not expressly approved by the party responsible for compliance could void the user's authority to operate the equipment.

NOTE: This equipment has been tested and found to comply with the limits for a Class B digital device, pursuant to Part 15 of the FCC Rules. These limits are designed to provide reasonable protection against harmful interference in a residential installation.

This equipment generates uses and can radiate radio frequency energy and, if not installed and used in accordance with the instructions, may cause harmful interference to radio communications.

However, there is no guarantee that interference will not occur in a particular installation. If this equipment does cause harmful interference to radio or television reception, which can be determined by turning the equipment off and on, the user is encouraged to try to correct the interference by one or more of the following measures:

Reorient or relocate the receiving antenna.

Increase the separation between the equipment and receiver.

Connect the equipment into an outlet on a circuit different from that to which the receiver is connected.

Consult the dealer or an experienced radio/TV technician for help.

FCC Radiation Exposure Statement

This equipment complies with FCC radiation exposure limits set forth for an uncontrolled environment. This equipment should be installed and operated with minimum distance 20cm between the radiator & your body.

EU DECLARATION OF CONFORMITY

Apparatus/Equipment

Product: Botslab Robot Mop

Model: M20

Supplied Accessories: Self-cleaning base, power cable and plug

Manufacturer

Name: BOTSLAB INC.

Address: 919 North Market St., Suite 950, Wilmington, New Castle, U.S., Zip code: 19801

This declaration of conformity is issued under the sole responsibility of the manufacturer.

The object of the declaration described above is in conformity with the following relevant Union harmonization directives and/or legislation(s):

Radio Equipment Directive (RED)	2014/53/EU	<input checked="" type="checkbox"/>
Low Voltage Directive (LVD)	2014/35/EU	<input type="checkbox"/>
Electromagnetic Compatibility Directive (EMCD)	2014/30/EU	<input type="checkbox"/>
Restriction of the use of certain hazardous substances (RoHS)	2011/65/EU	<input checked="" type="checkbox"/>
Ecodesign Requirements for energy-related products (ErP)	2009/125/EC	<input type="checkbox"/>

References to the relevant standards used, including the date of the standard, or references to the other technical specifications, including the date of the specification, in relation to which conformity is declared:

2011/65/EU: IEC 62321-5:2013; IEC 62321-6:2015; IEC 62321-7-1:2015; IEC 62321-8:2017

The 2.4 GHz band is limited to operate between 2412 MHz – 2472 MHz with a maximum EIRP output power of 20 dBm at 2412 MHz.

2014/53/EU:

Article 3.1a: EN 60335-1:2012+A11:2014+A13:2017; EN 60335-2-2:2010+A11:2012+A1:2013; EN 62233:2008; EN IEC 62311:2020; EN50665:2017

Article 3.1b: ETSI EN 301 489 -17 V3.2.4(2020-09); EN IEC 55014-1:2021; EN IEC 55014-2:2021

Article 3.2: EN 300328 V2.2.2(2019-07)

Signed for and on behalf of: BOTSLAB INC.

Place and date of issue: 919 North Market St., Suite 950, Wilmington, New Castle, U.S., Zip code: 19801

Signature: Hao Tianguang

Name, function: Hao Tianguang Certification Manager **Date:** 2021/09/30