



FCC TEST REPORT

**Test report
On Behalf of
Shenzhen DXR Electronic Technology Co., Limited (Dongguan Branch)
For
3-in-1 Wireless Charging Station
Model No.: MIC-MWS01
FCC ID: 2A22V-MWS01**

Prepared For : Shenzhen DXR Electronic Technology Co., Limited (Dongguan Branch)
4th Floor, #5 Building, #189, Yongji Industrial, Zhuweitian, Fenggang Town,
Dongguan, China

Prepared By : Shenzhen HUAK Testing Technology Co., Ltd.
1-2/F., Building B2, Junfeng Zhongcheng Zhizao Innovation Park, Heping,
Fuhai Street, Bao'an District, Shenzhen, Guangdong, China

Date of Test: May. 23, 2022 ~ May. 30, 2022

Date of Report: May. 30, 2022

Report Number: HK2203221084-1E



TEST RESULT CERTIFICATION

Applicant's name : Shenzhen DXR Electronic Technology Co., Limited (Dongguan Branch)

Address : 4th Floor, #5 Building, #189, Yongji Industrial, Zhuweitian, Fenggang Town, Dongguan, China

Manufacturer's Name : Shenzhen DXR Electronic Technology Co., Limited (Dongguan Branch)

Address : 4th Floor, #5 Building, #189, Yongji Industrial, Zhuweitian, Fenggang Town, Dongguan, China

Product description

Trade Mark: MERKURY

Product name: 3-in-1 Wireless Charging Station

Model and/or type reference : MIC-MWS01

Standards : FCC CFR 47 PART 18

This publication may be reproduced in whole or in part for non-commercial purposes as long as the Shenzhen HUAKE Testing Technology Co., Ltd. is acknowledged as copyright owner and source of the material. Shenzhen HUAKE Testing Technology Co., Ltd. takes no responsibility for and will not assume liability for damages resulting from the reader's interpretation of the reproduced material due to its placement and context.

Date of Test :

Date (s) of performance of tests : May. 23, 2022 ~ May. 30, 2022

Date of Issue : May. 30, 2022

Test Result : Pass

Testing Engineer :

Gary Qian

(Gary Qian)

Technical Manager :

Eden Hu

(Eden Hu)

Authorized Signatory :

Jason Zhou

(Jason Zhou)

**Table of Contents****Page**

| | |
|--|----|
| 1 . TEST SUMMARY | 5 |
| 1.1 . Test Procedures And Results | 5 |
| 1.2 . Information of the Test Laboratory | 5 |
| 1.3 . Measurement Uncertainty | 5 |
| 2. GENERAL INFORMATION | 6 |
| 2.1. General Description of EUT | 6 |
| 2.2. Carrier Frequency of Channels | 7 |
| 2.3. Operation of EUT during testing | 7 |
| 2.4. Test Mode | 7 |
| 2.5. Description of Test Setup | 8 |
| 2.6. Measurement Instruments List | 9 |
| 3. CONDUCTED EMISSION TEST | 10 |
| 3.1. Block Diagram of Test Setup | 10 |
| 3.2. Conducted Power Line Emission Limit | 10 |
| 3.3. Test Procedure | 10 |
| 4. RADIATED EMISSIONS | 13 |
| 4.1. Block Diagram of Test Setup | 13 |
| 4.2. Rules and specifications | 13 |
| 4.3. Test Procedure | 14 |
| 4.4. Test Result | 14 |
| 5. ANTENNA REQUIREMENT | 18 |
| 6. PHOTOGRAPH OF TEST | 19 |
| 7. PHOTOS OF THE EUT | 21 |



**** Modified History ****

| Revision | Description | Issued Data | Remark |
|-----------------|-----------------------------|--------------------|---------------|
| Revision 1.0 | Initial Test Report Release | May. 30, 2022 | Jason Zhou |
| | | | |
| | | | |



1. TEST SUMMARY

1.1. Test Procedures And Results

| DESCRIPTION OF TEST | SECTION NUMBER | RESULT |
|--------------------------|----------------|-----------|
| CONDUCTED EMISSIONS TEST | 18.307 | COMPLIANT |
| RADIATED EMISSION TEST | 18.305 | COMPLIANT |

Note:

1. PASS: Test item meets the requirement.
2. Fail: Test item does not meet the requirement.
3. N/A: Test case does not apply to the test object.
4. The test result judgment is decided by the limit of test standard.

1.2. Information of the Test Laboratory

Shenzhen HUAK Testing Technology Co., Ltd.
 Add.: 1-2/F., Building B2, Junfeng Zhongcheng Zhizao Innovation Park, Heping,
 Fuhai Street, Bao'an District, Shenzhen, Guangdong, China

Testing Laboratory Authorization :
 A2LA Accreditation Code is 4781.01.
 FCC Designation Number is CN1229.
 Canada IC CAB identifier is CN0045.
 CNAS Registration Number is L9589.

1.3. Measurement Uncertainty

| | |
|---|---------------|
| Measurement Uncertainty | |
| Conducted Emission Expanded Uncertainty | = 2.71dB, k=2 |
| Radiated emission expanded uncertainty(9kHz-30MHz) | = 3.90dB, k=2 |
| Radiated emission expanded uncertainty(30MHz-1000MHz) | = 3.90dB, k=2 |
| Radiated emission expanded uncertainty(Above 1GHz) | = 4.28dB, k=2 |



2. GENERAL INFORMATION

2.1. General Description of EUT

| | |
|----------------------|--|
| Equipment: | 3-in-1 Wireless Charging Station |
| Model Name: | MIC-MWS01 |
| Series Models: | N/A |
| Model Difference: | N/A |
| Trade Mark: | MERKURY |
| FCC ID: | 2A22V-MWS01 |
| Antenna Type: | Coil Antenna |
| Antenna Gain: | 0dBi |
| Operation frequency: | 111.5KHz~205KHz |
| Test frequency: | 122KHz |
| Number of Channels: | 1 |
| Modulation Type: | ASK |
| Power Source: | Input: DC 9V 2A Wireless Charger Output #1 (Phone): 5W, 7.5W, 10W Wireless Charger Output #2 (Airpods): 5W Wireless Charger Output #3 (Apple Watch): 2W Wireless Charger Output Total: 18W |
| Power Rating: | Input: DC 9V 2A Wireless Charger Output #1 (Phone): 5W, 7.5W, 10W Wireless Charger Output #2 (Airpods): 5W Wireless Charger Output #3 (Apple Watch): 2W Wireless Charger Output Total: 18W |

The results shown in this test report refer only to the sample(s) tested unless otherwise stated and the sample(s) are retained for 30 days only. The document is issued by HUAK, this document cannot be reproduced except in full with our prior written permission. The more details and the authenticity of the report will be confirmed at <http://www.cer-mark.com>.



2.2. Carrier Frequency of Channels

| | |
|-------------------------------------|-----------|
| Operation Frequency each of channel | |
| Channel | Frequency |
| 1 | 122KHz |

2.3. Operation of EUT during testing

Operating Mode

The mode is used: Transmitting mode

2.4. Test Mode

| EUT Mode | Description |
|----------------|---|
| ANT 1 | Cell load setting 10W |
| | Cell load setting 7.5W |
| | Cell load setting 5W |
| ANT 2 | Cell Airpods setting 5W |
| ANT 3 | Cell Watch setting 2W |
| ANT 1+ANT 2 | Cell load setting 10W + Cell Airpods setting 5W |
| ANT 1+ANT 3 | Cell load setting 10W + Cell Watch setting 2W |
| ANT 2+ANT 3 | Cell Airpods setting 5W + Cell Watch setting 2W |
| ANT1+ANT2+ANT3 | Cell load setting 10W + Cell Airpods setting 5W + Cell Watch setting 2W |



2.5. Description of Test Setup

Operation of EUT during testing:

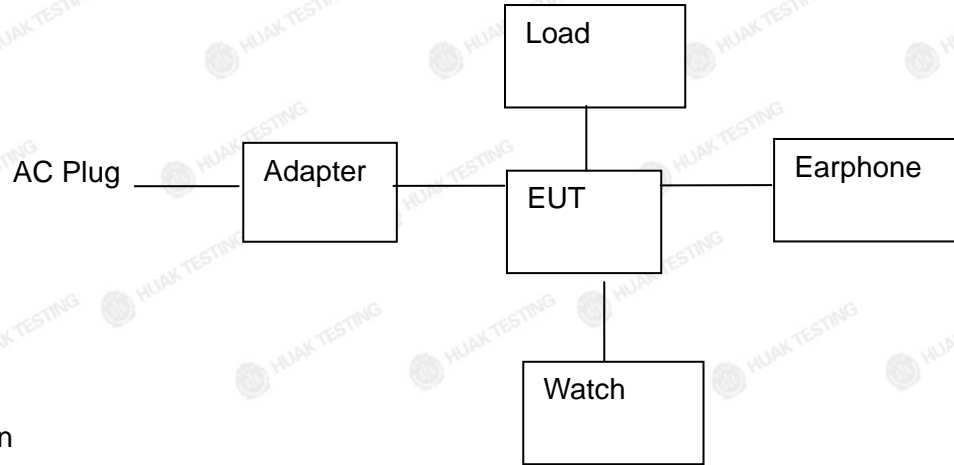

Watch information

Model: Watch
Input: DC 5V

Earphone information

Model: Airpods
Input: DC 5V

Adapter information

Model:UP0920
Input: AC100-240V, 50-60Hz, 0.5A
Output: 5VDC 2A, 9VDC 2A

The sample was placed (0.8m (30MHz~1GHz), 0.8m (9KHz~30MHz)) above the ground plane of 3m chamber. Measurements in both horizontal and vertical polarities were performed. During the test, each emission was maximized by: having the EUT continuously working, investigated all operating modes, rotated about all 3 axis (X, Y & Z) and considered typical configuration to obtain worst position, manipulating interconnecting cables, rotating the turntable, varying antenna height from 1m to 4m in both horizontal and vertical polarizations. The emissions worst-case are shown in Test Results of the following pages. The worst case is X position.

**2.6. Measurement Instruments List**

| Item | Equipment | Manufacturer | Model No. | Serial No. | Last Cal. | Cal. Interval |
|------|---|-----------------|---------------------|------------|---------------|---------------|
| 1. | L.I.S.N. Artificial Mains Network | R&S | ENV216 | HKE-002 | Feb. 18, 2022 | 1 Year |
| 2. | Receiver | R&S | ESCI 7 | HKE-010 | Feb. 18, 2022 | 1 Year |
| 3. | RF automatic control unit | Tonscend | JS0806-2 | HKE-060 | Feb. 18, 2022 | 1 Year |
| 4. | Spectrum analyzer | R&S | FSP40 | HKE-025 | Feb. 18, 2022 | 1 Year |
| 5. | Spectrum analyzer | Agilent | N9020A | HKE-048 | Feb. 18, 2022 | 1 Year |
| 6. | Preamplifier | Schwarzbeck | BBV 9743 | HKE-006 | Feb. 18, 2022 | 1 Year |
| 7. | EMI Test Receiver | Rohde & Schwarz | ESCI 7 | HKE-010 | Feb. 18, 2022 | 1 Year |
| 8. | Bilog Broadband Antenna | Schwarzbeck | VULB9163 | HKE-012 | Feb. 18, 2022 | 1 Year |
| 9. | Loop Antenna | Schwarzbeck | FMZB 1519 B | HKE-014 | Feb. 18, 2022 | 1 Year |
| 10. | Horn Antenna | Schwarzbeck | 9120D | HKE-013 | Feb. 18, 2022 | 1 Year |
| 11. | Pre-amplifier | EMCI | EMC051845 SE | HKE-015 | Feb. 18, 2022 | 1 Year |
| 12. | Pre-amplifier | Agilent | 83051A | HKE-016 | Feb. 18, 2022 | 1 Year |
| 13. | EMI Test Software EZ-EMC | Tonscend | JS1120-B Version | HKE-083 | N/A | N/A |
| 14. | Power Sensor | Agilent | E9300A | HKE-086 | Feb. 18, 2022 | 1 Year |
| 15. | Spectrum analyzer | Agilent | N9020A | HKE-048 | Feb. 18, 2022 | 1 Year |
| 16. | Signal generator | Agilent | N5182A | HKE-029 | Feb. 18, 2022 | 1 Year |
| 17. | Signal Generator | Agilent | 83630A | HKE-028 | Feb. 18, 2022 | 1 Year |
| 18. | Shielded room | Shiel Hong | 4*3*3 | HKE-039 | Dec. 17, 2020 | 3 Year |

The results shown in this test report refer only to the sample(s) tested unless otherwise stated and the sample(s) are retained for 30 days only. The document is issued by HUAK, this document cannot be reproduced except in full with our prior written permission. The more details and the authenticity of the report will be confirmed at <http://www.cer-mark.com>.

TEL : +86-755 2302 9901 FAX : +86-755 2302 9901 E-mail : service@cer-mark.com

Add: 1-2F., Building B2, Junfeng Zhongcheng Zhizao Innovation Park, Heping Community, Fuhai Street, Bao'an District, Shenzhen, Guangdong, China



3. CONDUCTED EMISSION TEST

3.1. Block Diagram of Test Setup

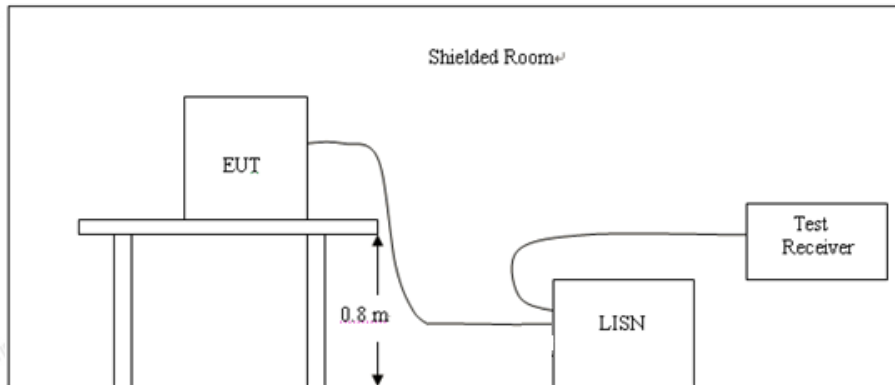

3.2. Conducted Power Line Emission Limit

According to FCC Part 18.307(b)

| Frequency (MHz) | Maximum RF Line Voltage (dBμV) | | | |
|-----------------|--------------------------------|------|---------|--------|
| | CLASS A | | CLASS B | |
| | Q.P. | Ave. | Q.P. | Ave. |
| 0.15 - 0.50 | 79 | 66 | 66-56* | 56-46* |
| 0.50 - 5.00 | 73 | 60 | 56 | 46 |
| 5.00 - 30.0 | 73 | 60 | 60 | 50 |

* Decreasing linearly with the logarithm of the frequency

For intentional device, according to §18.307 Line Conducted Emission Limit is same as above table.

3.3. Test Procedure

1. The equipment was set up as per the test configuration to simulate typical actual usage per the user's manual. The EUT is a tabletop system, a wooden table with a height of 0.8 meters is used and is placed on the ground plane as per ANSI C63.10.
2. Support equipment, if needed, was placed as per ANSI C63.10.
3. All I/O cables were positioned to simulate typical actual usage as per ANSI C63.10.
4. If a EUT received DC power from the USB Port of Notebook PC, the PC's adapter received AC120V/60Hz power through a Line Impedance Stabilization Network (LISN) which supplied power source and was grounded to the ground plane.
5. All support equipments received AC power from a second LISN, if any.
6. The EUT test program was started. Emissions were measured on each current carrying line of the EUT using a spectrum Analyzer / Receiver connected to the LISN powering the EUT. The LISN has two monitoring points: Line 1 (Hot Side) and Line 2 (Neutral Side). Two scans were taken: one with Line 1 connected to Analyzer / Receiver and Line 2 connected to a 50 ohm load; the second scan had Line 1 connected to a 50 ohm load and Line 2 connected to the Analyzer / Receiver.
7. Analyzer / Receiver scanned from 150 KHz to 30MHz for emissions in each of the test modes.



3.4. Test Result

PASS

All the test modes completed for test. Only the worst result (ANT1+ANT2+ANT3) was reported as below:

Test Specification: Line

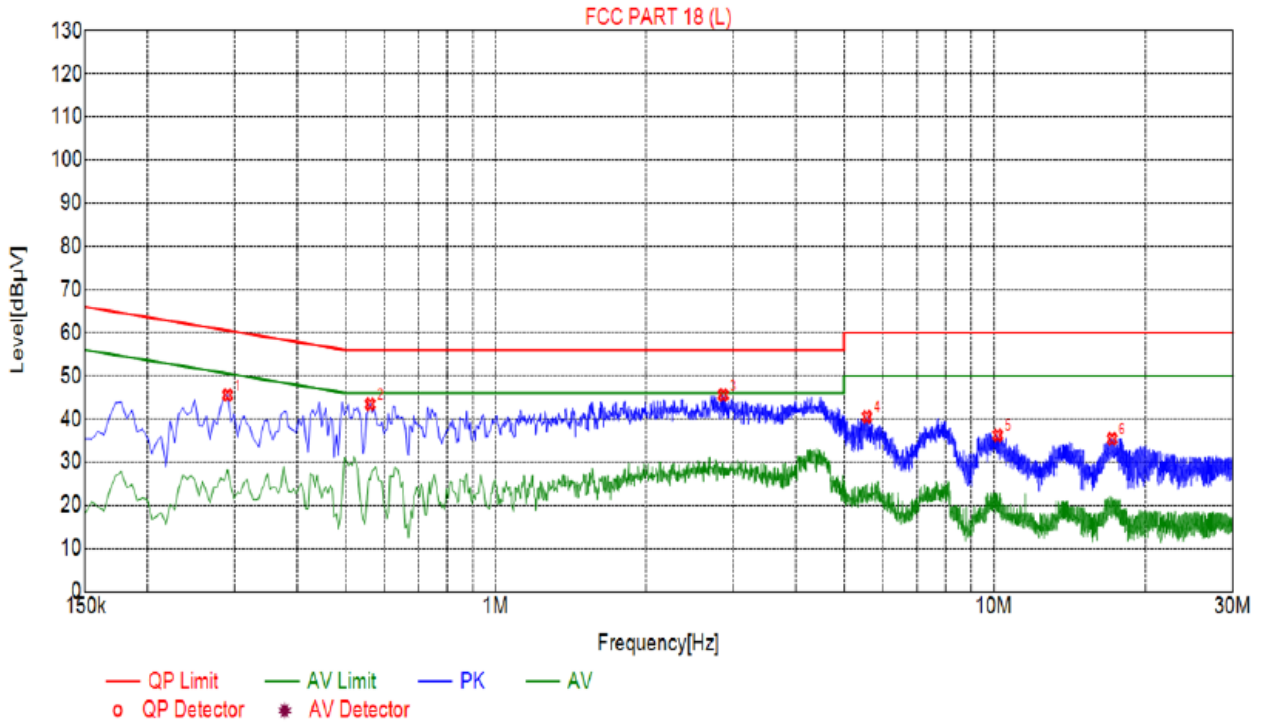

| Suspected List | | | | | | | | |
|----------------|-------------|--------------|-------------|--------------|-------------|----------------|----------|------|
| NO. | Freq. [MHz] | Level [dBµV] | Factor [dB] | Limit [dBµV] | Margin [dB] | Reading [dBµV] | Detector | Type |
| 1 | 0.2895 | 45.54 | 20.03 | 60.54 | 15.00 | 25.51 | PK | L |
| 2 | 0.5595 | 43.43 | 20.06 | 56.00 | 12.57 | 23.37 | PK | L |
| 3 | 2.8635 | 45.54 | 20.21 | 56.00 | 10.46 | 25.33 | PK | L |
| 4 | 5.5635 | 40.51 | 20.25 | 60.00 | 19.49 | 20.26 | PK | L |
| 5 | 10.1805 | 36.21 | 20.06 | 60.00 | 23.79 | 16.15 | PK | L |
| 6 | 17.1600 | 35.37 | 20.00 | 60.00 | 24.63 | 15.37 | PK | L |

Remark: Margin = Limit - Level

Correction factor = Cable lose + LISN insertion loss

Level=Test receiver reading + correction factor



Test Specification: Neutral

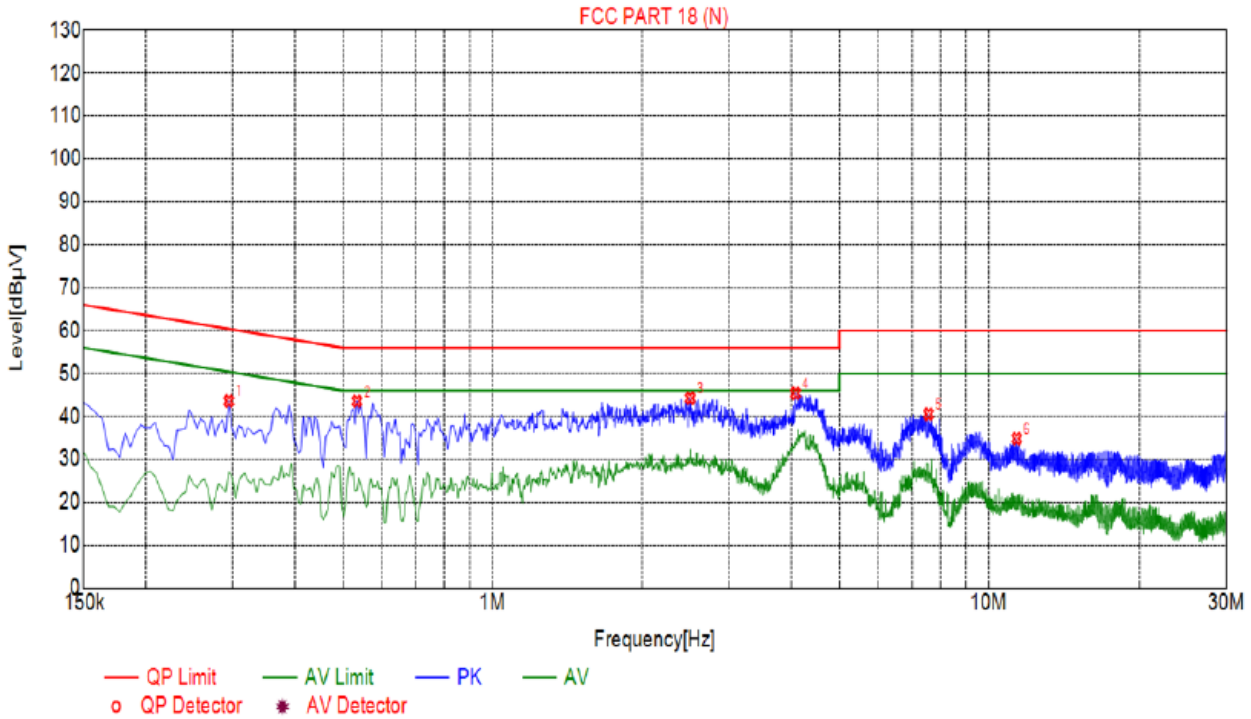

| Suspected List | | | | | | | | |
|----------------|-------------|--------------|-------------|--------------|-------------|----------------|----------|------|
| NO. | Freq. [MHz] | Level [dBµV] | Factor [dB] | Limit [dBµV] | Margin [dB] | Reading [dBµV] | Detector | Type |
| 1 | 0.2940 | 43.60 | 20.03 | 60.41 | 16.81 | 23.57 | PK | N |
| 2 | 0.5325 | 43.56 | 20.05 | 56.00 | 12.44 | 23.51 | PK | N |
| 3 | 2.5035 | 44.26 | 20.19 | 56.00 | 11.74 | 24.07 | PK | N |
| 4 | 4.0830 | 45.38 | 20.25 | 56.00 | 10.62 | 25.13 | PK | N |
| 5 | 7.5750 | 40.52 | 20.17 | 60.00 | 19.48 | 20.35 | PK | N |
| 6 | 11.3910 | 34.82 | 20.00 | 60.00 | 25.18 | 14.82 | PK | N |

Remark: Margin = Limit - Level

Correction factor = Cable lose + LISN insertion loss

Level=Test receiver reading + correction factor

4. RADIATED EMISSIONS

4.1. Block Diagram of Test Setup

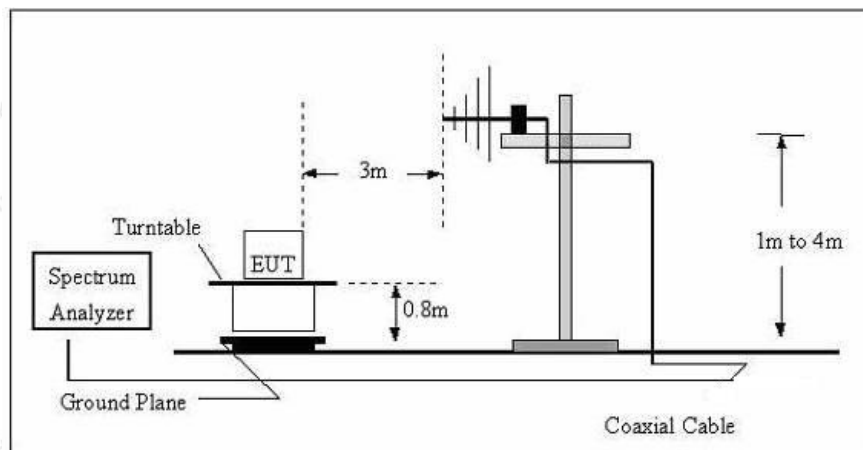
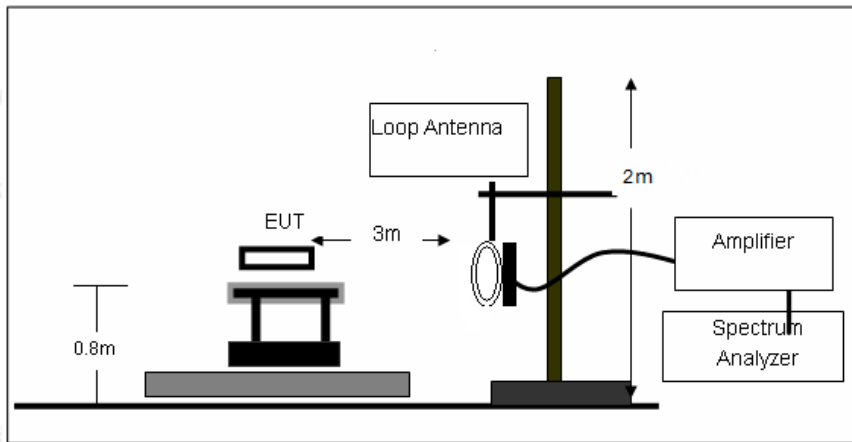

4.2. Rules and specifications

Except as provided elsewhere in this Subpart 18.305 (b), the field strength levels of emissions which lie outside the bands specified in §18.301, unless otherwise indicated, shall not exceed the following table:

| Equipment | Operating frequency | RF Power generated by equipment (watts) | Field strength limit (uV/m) | Distance (meters) |
|-----------------|-----------------------|---|-----------------------------|-------------------|
| (miscellaneous) | | | | |
| | Any non-ISM frequency | Below 500 500 or more | 15 15 × SQRT(power/500) | 300 1300 |



Remark:

- (1) Emission level dBuV/m for 0.009~30MHz = $20\log(15) + 40\log(300/3)$ dBuV/m;
- (2) Calculated according FCC 18.305.
- (3) The smaller limit shall apply at the cross point between two frequency bands.
- (4) Distance is the distance in meters between the measuring instrument, antenna and the closest point of any part of the device or system.

4.3. Test Procedure

Measurement distance 3m

For the measurement range up to 30MHz in the following plots the field strength result from 3m

Distance measurement are extrapolated to 300m and 30m distance respectively, by 40dB/decade,

According to part 15.31(f)(2), per antenna factor scaling.

Measurements below 1000MHz are performed with a peak detector and compared to average limits,

Measurements with an average detector are not required.

Note:

For battery operated equipment, the equipment tests shall be performed using a new battery.

4.4. Test Result

PASS

Note: All the test modes completed for test. Only the worst result (ANT1+ANT2+ANT3) was reported as below:



For 9KHz - 30MHz

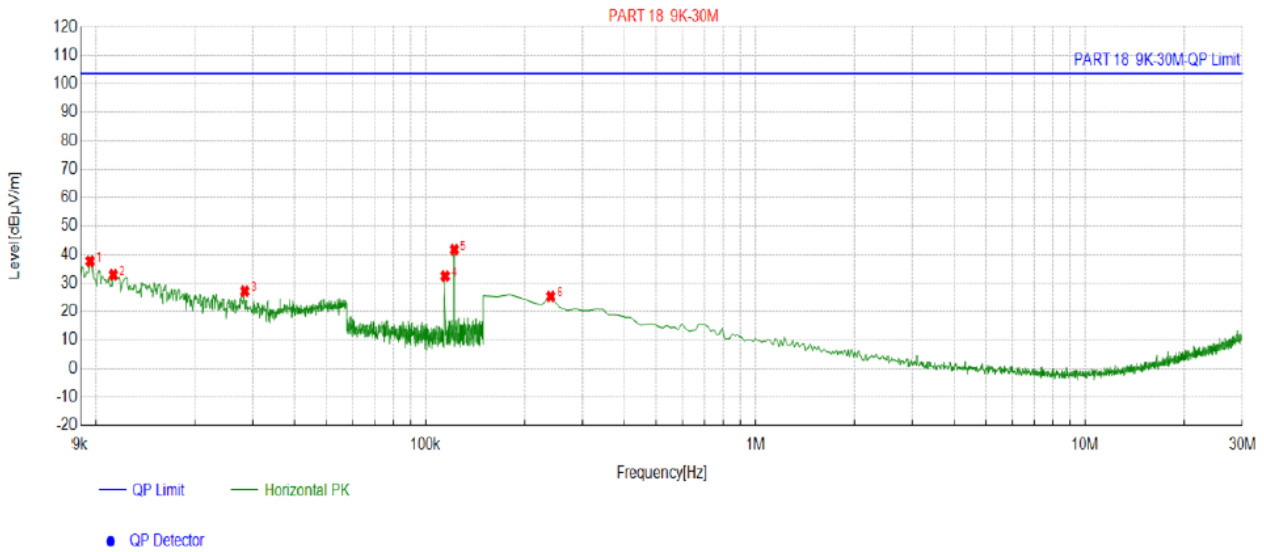

| Suspected List | | | | | | |
|----------------|-------------|-------------|------------------|----------------|----------------|-------------|
| NO. | Freq. [MHz] | Factor [dB] | Reading [dBµV/m] | Level [dBµV/m] | Limit [dBµV/m] | Margin [dB] |
| 1 | 0.0096 | -13.97 | 51.65 | 37.68 | 103.50 | 65.82 |
| 2 | 0.0113 | -14.72 | 47.57 | 32.85 | 103.50 | 70.65 |
| 3 | 0.0283 | -16.43 | 43.59 | 27.16 | 103.50 | 76.34 |
| 4 | 0.1146 | -17.18 | 49.64 | 32.46 | 103.50 | 71.04 |
| 5 | 0.1221 | -17.19 | 58.89 | 41.70 | 103.50 | 61.80 |
| 6 | 0.2396 | -17.37 | 42.70 | 25.33 | 103.50 | 78.17 |

Remark: Factor = Cable loss + Antenna factor – Preamplifier; Level = Reading + Factor; Margin = Limit – Level



For 30MHz-1GHz

Antenna polarity: H



| Suspected List | | | | | | | | | |
|----------------|-------------|-------------|------------------|----------------|----------------|-------------|-------------|-----------|------------|
| NO. | Freq. [MHz] | Factor [dB] | Reading [dBµV/m] | Level [dBµV/m] | Limit [dBµV/m] | Margin [dB] | Height [cm] | Angle [°] | Polarity |
| 1 | 91.1712 | -16.86 | 41.09 | 24.23 | 63.50 | 39.27 | 100 | 9 | Horizontal |
| 2 | 163.9940 | -17.17 | 44.87 | 27.70 | 63.50 | 35.80 | 100 | 266 | Horizontal |
| 3 | 224.1942 | -14.24 | 42.85 | 28.61 | 63.50 | 34.89 | 100 | 290 | Horizontal |
| 4 | 294.1041 | -12.51 | 48.40 | 35.89 | 63.50 | 27.61 | 100 | 274 | Horizontal |
| 5 | 359.1592 | -11.49 | 50.48 | 38.99 | 63.50 | 24.51 | 100 | 274 | Horizontal |
| 6 | 430.0400 | -8.93 | 45.03 | 36.10 | 63.50 | 27.40 | 100 | 246 | Horizontal |

Remark: Factor = Cable loss + Antenna factor – Preamplifier; Level = Reading + Factor; Margin = Limit – Level



Antenna polarity: V

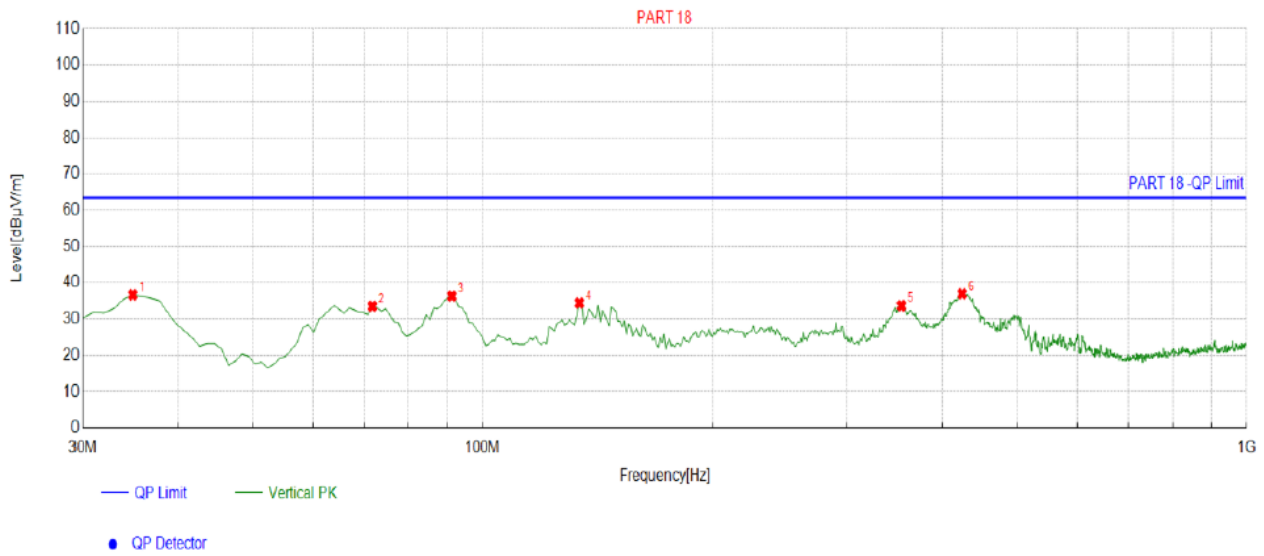

| Suspected List | | | | | | | | | |
|----------------|-------------|-------------|------------------|----------------|----------------|-------------|-------------|-----------|----------|
| NO. | Freq. [MHz] | Factor [dB] | Reading [dBµV/m] | Level [dBµV/m] | Limit [dBµV/m] | Margin [dB] | Height [cm] | Angle [°] | Polarity |
| 1 | 34.8549 | -16.30 | 52.99 | 36.69 | 63.50 | 26.81 | 100 | 224 | Vertical |
| 2 | 71.7518 | -16.40 | 49.92 | 33.52 | 63.50 | 29.98 | 100 | 354 | Vertical |
| 3 | 91.1712 | -16.86 | 53.18 | 36.32 | 63.50 | 27.18 | 100 | 357 | Vertical |
| 4 | 133.8939 | -17.40 | 51.82 | 34.42 | 63.50 | 29.08 | 100 | 201 | Vertical |
| 5 | 353.3333 | -11.72 | 45.39 | 33.67 | 63.50 | 29.83 | 100 | 70 | Vertical |
| 6 | 424.2142 | -9.19 | 46.15 | 36.96 | 63.50 | 26.54 | 100 | 4 | Vertical |

Remark: Factor = Cable loss + Antenna factor – Preamplifier; Level = Reading + Factor;
 Margin = Limit – Level

5. ANTENNA REQUIREMENT

Refer to statement below for compliance.

The manufacturer may design the unit so that the user can replace a broken antenna, but the use of a standard antenna jack or electrical connector is prohibited. Further, this requirement does not apply to intentional radiators that must be professionally installed.

Antenna Connected Construction

The antenna used in this product is a Coil Antenna, which permanently attached. It conforms to the standard requirements. The directional gains of antenna used for transmitting is 0dBi.

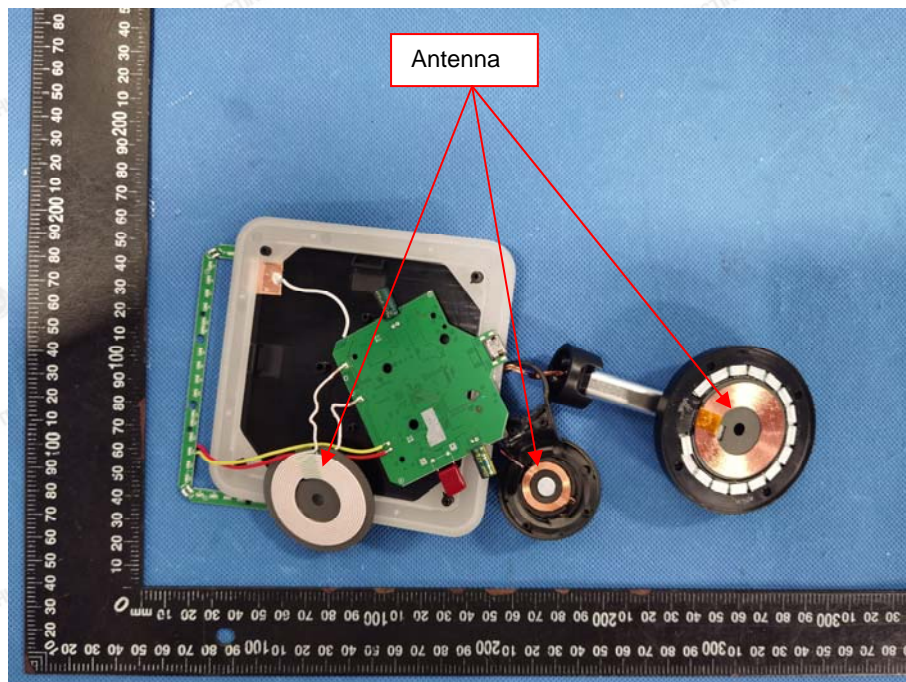



6. PHOTOGRAPH OF TEST

Radiated Emission

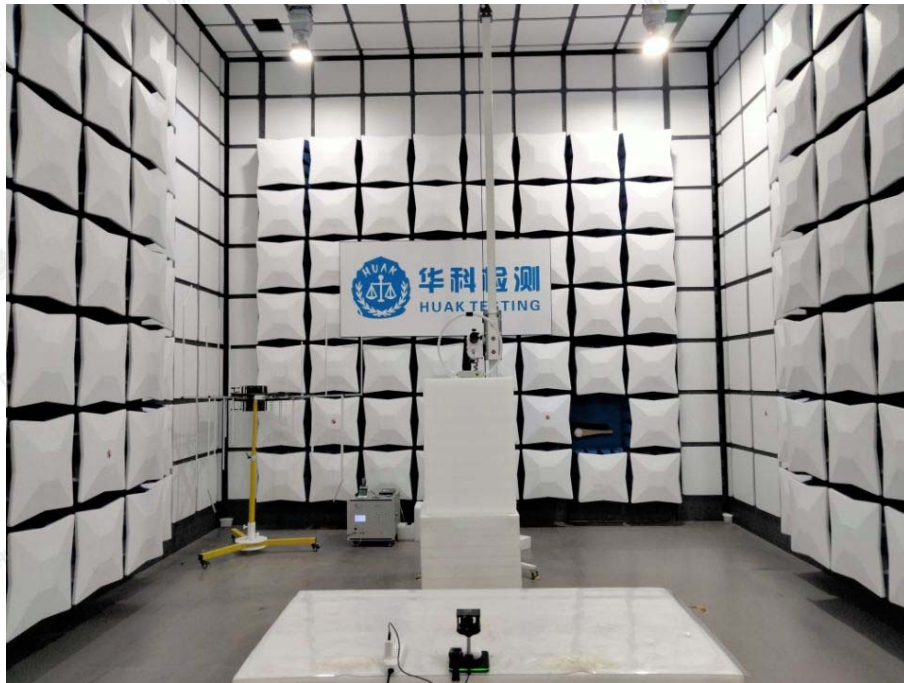
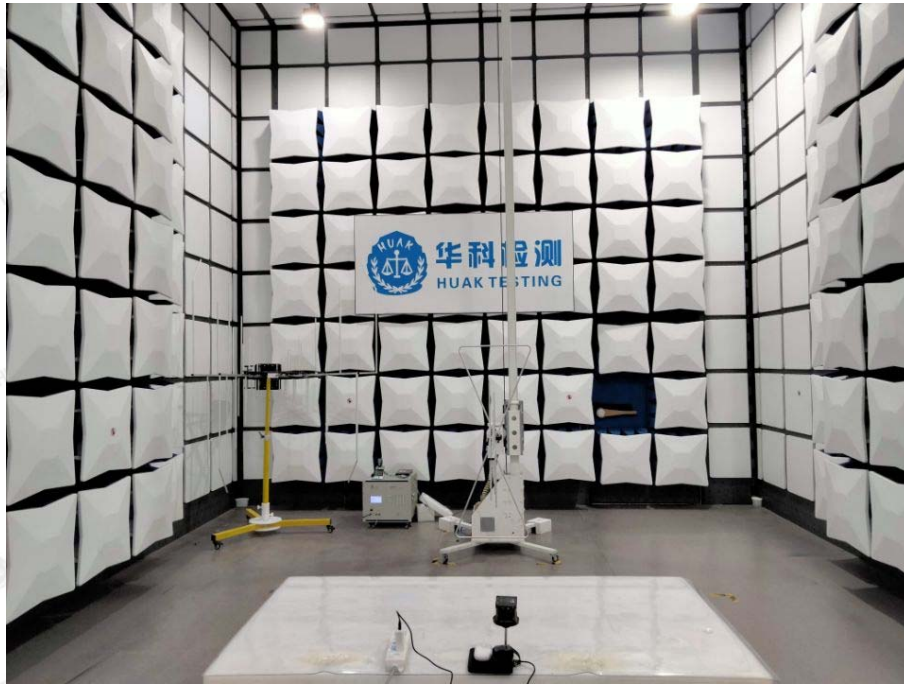

The results shown in this test report refer only to the sample(s) tested unless otherwise stated and the sample(s) are retained for 30 days only. The document is issued by HUAKE, this document cannot be reproduced except in full with our prior written permission. The more details and the authenticity of the report will be confirmed at <http://www.cer-mark.com>.

TEL : +86-755 2302 9901 FAX : +86-755 2302 9901 E-mail : service@cer-mark.com

Addr: 1-2F., Building B2, Junfeng Zhongcheng Zhizao Innovation Park, Heping Community, Fuhai Street, Bao'an District, Shenzhen, Guangdong, China



Conducted Emissions



The results shown in this test report refer only to the sample(s) tested unless otherwise stated and the sample(s) are retained for 30 days only. The document is issued by HUAK, this document cannot be reproduced except in full with our prior written permission. The more details and the authenticity of the report will be confirmed at <http://www.cer-mark.com>.

TEL : +86-755 2302 9901 FAX : +86-755 2302 9901 E-mail : service@cer-mark.com

Addr: 1-2F., Building B2, Junfeng Zhongcheng Zhizao Innovation Park, Heping Community, Fuhai Street, Bao'an District, Shenzhen, Guangdong, China



7. PHOTOS OF THE EUT

Reference to the report: ANNEX A of external photos and ANNEX B of internal photos.

-----End of test report-----