



深圳自由行通信技术有限公司
Shenzhen Free Walk Communication Technology Co. LTD

ADD: 3rd Floor, Building 2, Industrial Park, Hezhou West District, Bao'an West Township, Shenzhen

Email: zyx@sz-freewalk.com

TEL: 86-0755-29955983

FAX: 86-0755-29955983

客户 (Customer) : **Micronet Union Technology**

产品 (Product) : **5G-exposed antenna (L=70mm)**

型号 (Model) : **51010050**

料号 (Part Number) : **Z01-50104-R01**

The basic parameters

A. Electrical Characteristics	
Frequency	5150 MHz ~5850MHz
VSWR	≤2
Efficiency	>60%
Impedance	50 Ohm
Polarization	Linear
Gain	5dBi±1
B. Material & Mechanical Characteristics	
Material of Radiator	
Cable Type	Φ1.37mm Black
Connector Type	FIRST GEN.IPEX
Dimension	
C. Environmental	
Operation Temperature	- 20 °C ~ + 60 °C
Storage Temperature	- 40 °C ~ + 80 °C



NAME	NAME	MATEL/Spec	COLOR	QTY	note
①	RF cable	1.3/coaxial line	BLACK	1	
②	Lower mount	ABS+PC	WHITE	1	
③	Sleeve	ABS	WHITE	1	
④	PCB	FR-4	BLACK	1	
⑤	spring	carbon steel	SILVER	1	
⑥	Terminal	first gen	GOLDEN	1	
⑦					

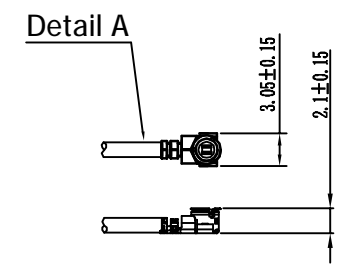
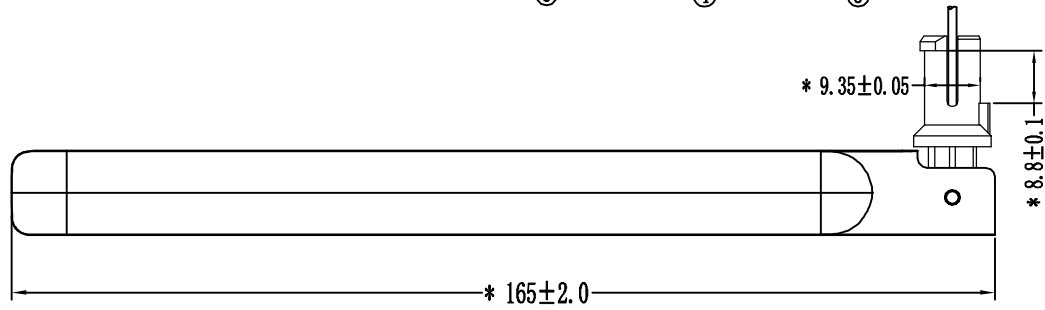
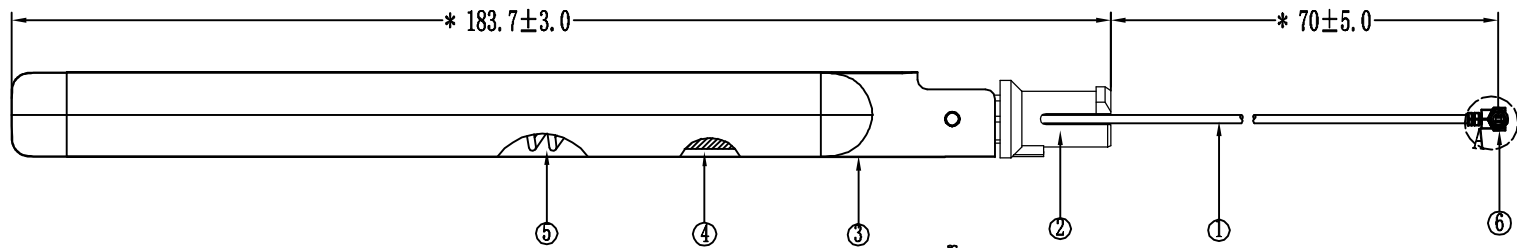

Test Equipment & Conditions

1. Network Analyzers :

Agilent 8753D 5071C

2. Communications Test Set:

Agilent 8960 CMW500

3. 3D Chamber Test System

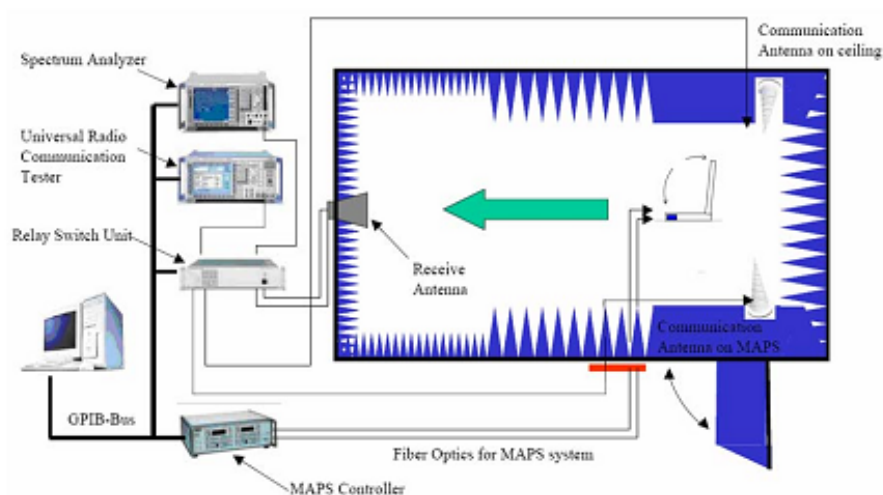

(Testing by 3D anechoic chamber)

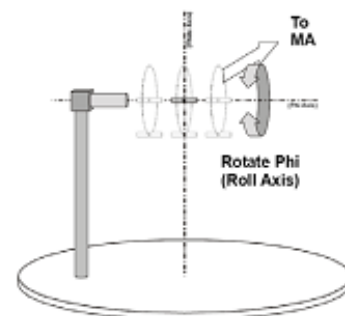

Phi axis test

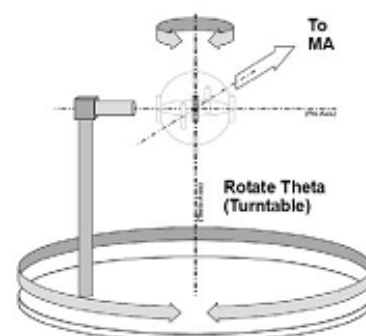

Theta axis test

Test Data

SWR

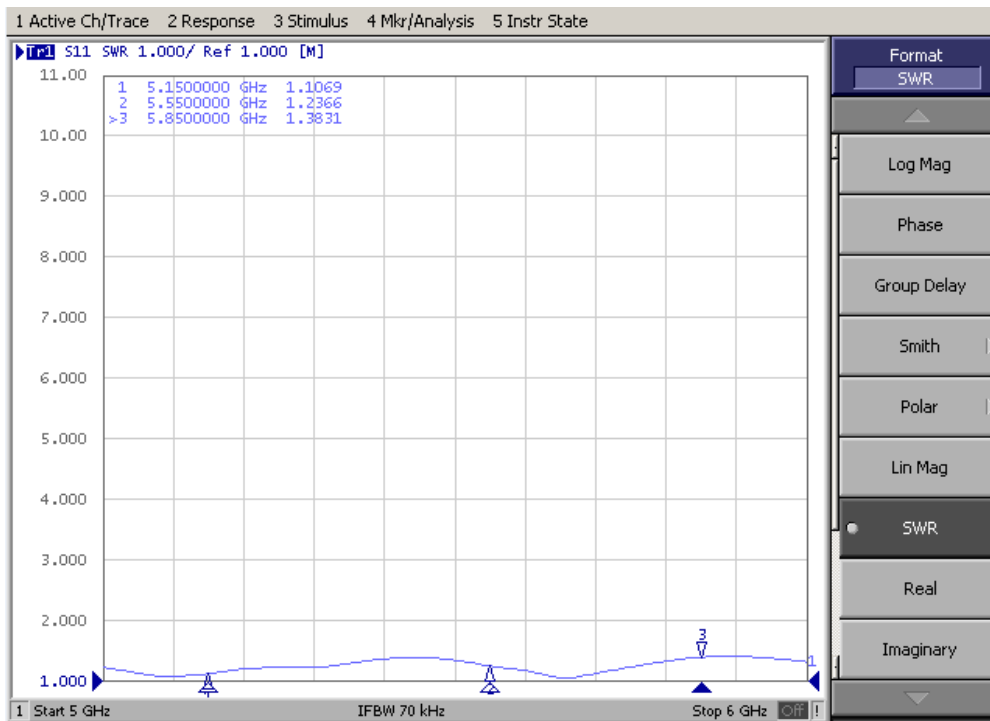

Smith

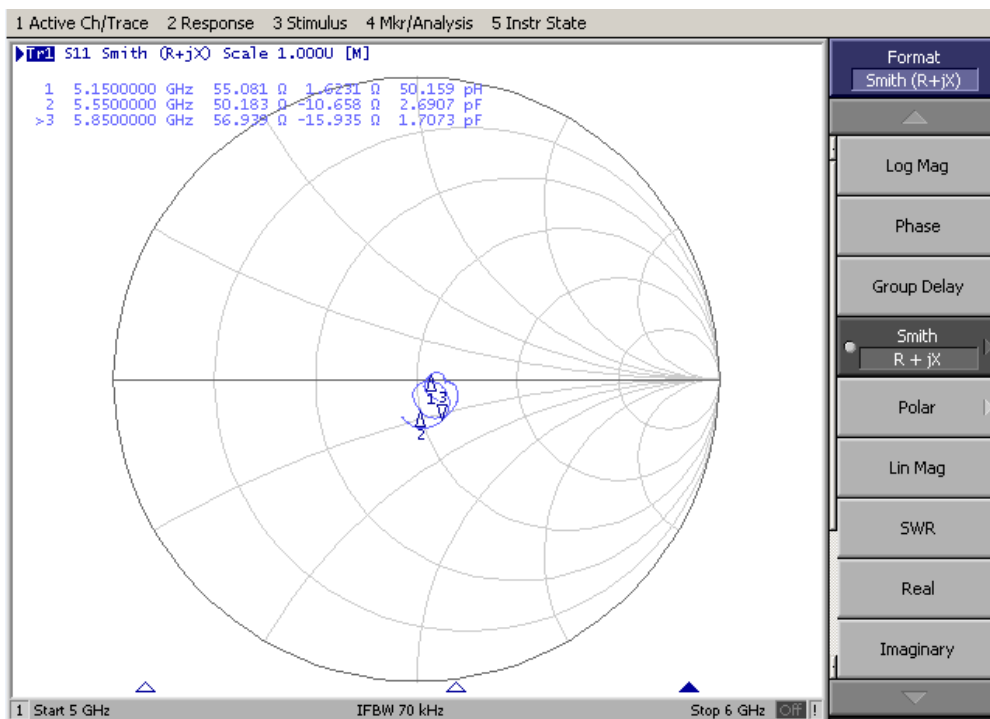

效率&增益:

Efficiency&Gain

Frequency / MHz	Efficiency / %	Gain/ dBi
5150	71.09	5.07
5200	70.95	5.04
5250	67.54	4.80
5300	72.42	5.18
5350	70.95	4.87
5400	73.83	4.70
5450	74.78	5.20
5500	68.61	4.90
5550	67.02	4.73
5600	72.27	4.83
5650	69.98	4.85
5700	68.21	4.70
5750	69.29	4.80
5800	68.36	4.82
5850	70.26	4.80

3D Patten

5150MHz

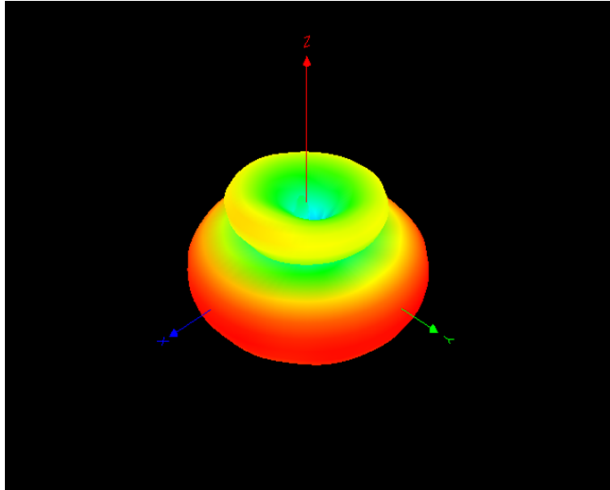

5550MHz

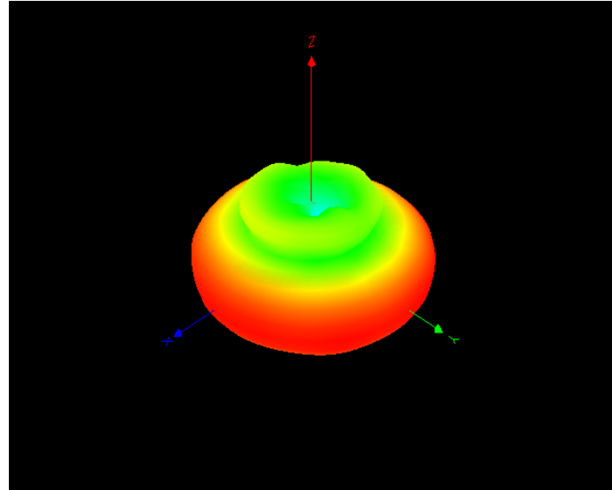

5850MHz

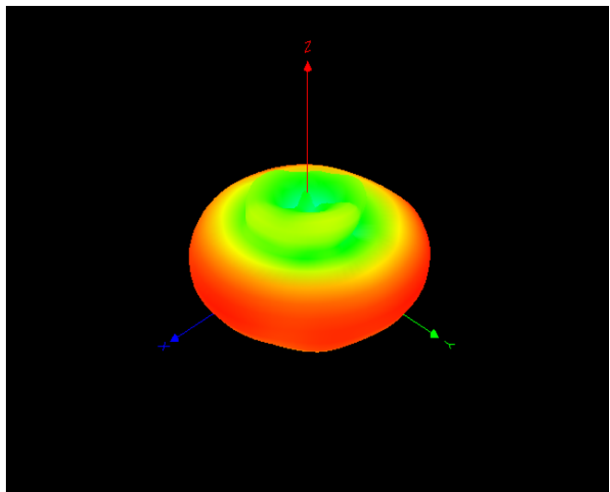

2D Patten

XOY- p l a n e

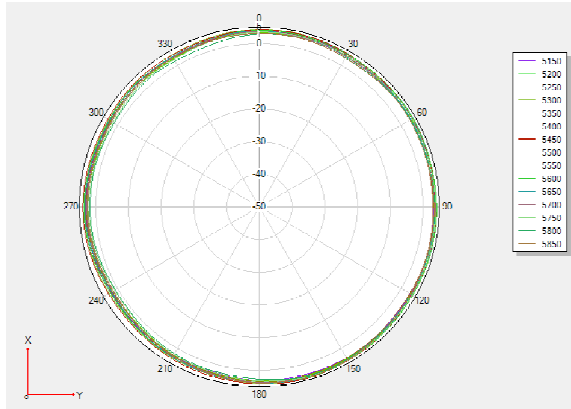

ZOX- p l a n e

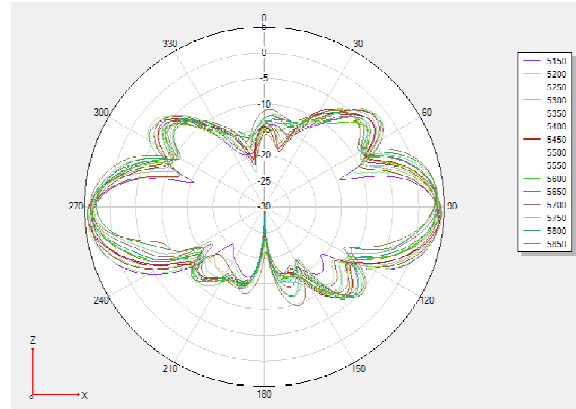

ZOY- p l a n e

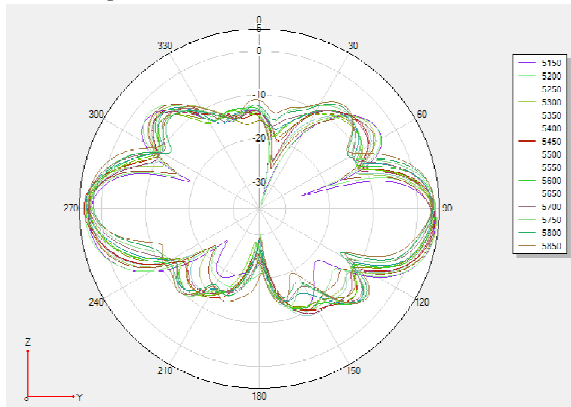

Antenna picture

