

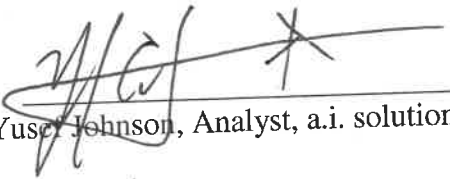

ELVL-2018-0045207 Rev C
June 20, 2018

**Orbital Debris Assessment for
The CubeSats on the
CRS OA-10/ELaNa-21 Mission
per NASA-STD 8719.14A**

Signature Page

Yusef Johnson, Analyst, a.i. solutions, AIS2

Scott Higginbotham, Mission Manager, NASA KSC VA-C

National Aeronautics and
Space Administration

John F. Kennedy Space Center, Florida
Kennedy Space Center, FL 32899



ELVL-2018-0045207 Rev B

Reply to Attn of: VA-H1

June 20, 2018

TO: Scott Higginbotham, LSP Mission Manager, NASA/KSC/VA-C

FROM: Yusef Johnson, a.i. solutions/KSC/AIS2

SUBJECT: Orbital Debris Assessment Report (ODAR) for the ELaNa-21 Mission

REFERENCES:

- A. *NASA Procedural Requirements for Limiting Orbital Debris Generation*, NPR 8715.6A, 5 February 2008
- B. *Process for Limiting Orbital Debris*, NASA-STD-8719.14A, 25 May 2012
- C. International Space Station Reference Trajectory, delivered May 2017
- D. McKissock, Barbara, Patricia Loyselle, and Elisa Vogel. *Guidelines on Lithium-Battery Use in Space Applications*. Tech. no. RP-08-75. NASA Glenn Research Center Cleveland, Ohio
- E. *UL Standard for Safety for Lithium Batteries, UL 1642*. UL Standard. 4th ed. Northbrook, IL, Underwriters Laboratories, 2007
- F. Kwas, Robert. Thermal Analysis of ELaNa-4 CubeSat Batteries, ELVL-2012-0043254; Nov 2012
- G. Range Safety User Requirements Manual Volume 3- Launch Vehicles, Payloads, and Ground Support Systems Requirements, AFSCM 91-710 V3.
- H. HQ OSMA Policy Memo/Email to 8719.14: CubeSat Battery Non-Passivation, Suzanne Aleman to Justin Treptow, 10, March 2014
- I. HQ OSMA Email:6U CubeSat Battery Non Passivation Suzanne Aleman to Justin Treptow, 8 August 2017
- J. *TechEdSat-8 Orbital Debris Assessment Report (ODAR)*, T8MP-06-XS001 Rev 0, NASA Ames Research Center

The intent of this report is to satisfy the orbital debris requirements listed in ref. (a) for the ELaNa-21 auxiliary mission launching on the CRS OA-10 vehicle. It serves as the final submittal in support of the spacecraft Safety and Mission Success Review (SMSR). Sections 1 through 8 of ref. (b) are addressed in this document; sections 9 through 14 fall under the requirements levied on the primary mission and are not presented here.

RECORD OF REVISIONS		
REV	DESCRIPTION	DATE
0	ODAR Submission for TJREVERB and VCC CubeSats	March 2018
A	Combined original submission with full ELaNa-21 complement	May 2018
B	Updated mass properties for CySat	June 2018
C	Incorporated changes to VCC CubeSats CONOPS	June 2018

The following table summarizes the compliance status of the ELaNa-21 payload mission to be flown on the OA-10 vehicle. The 13 CubeSats comprising the ELaNa-21 mission are fully compliant with all applicable requirements.

Table 1: Orbital Debris Requirement Compliance Matrix

Requirement	Compliance Assessment	Comments
4.3-1a	Not applicable	No planned debris release
4.3-1b	Not applicable	No planned debris release
4.3-2	Not applicable	No planned debris release
4.4-1	Compliant	On board energy source (batteries) incapable of debris-producing failure
4.4-2	Compliant	On board energy source (batteries) incapable of debris-producing failure
4.4-3	Not applicable	No planned breakups
4.4-4	Not applicable	No planned breakups
4.5-1	Compliant	
4.5-2	Not applicable	
4.6-1(a)	Compliant	Worst case lifetime 3.9 yrs
4.6-1(b)	Not applicable	
4.6-1(c)	Not applicable	
4.6-2	Not applicable	
4.6-3	Not applicable	
4.6-4	Not applicable	Passive disposal
4.6-5	Compliant	
4.7-1	Compliant	Non-credible risk of human casualty
4.8-1	Compliant	No planned tether release under ELaNa-21 mission

Section 1: Program Management and Mission Overview

The ELaNa-21 mission is sponsored by the Human Exploration and Operations Mission Directorate at NASA Headquarters. The Program Executive is Jason Crusan. Responsible program/project manager and senior scientific and management personnel are as follows:

CapSat: McKale Berg, Project Manager, University of Illinois

CySat 1: Rami Shoukih, Project Manager, Iowa State University

KickSat-2: BJ Jaroux, Project Manager, NASA Ames Research Center

HARP: Dr. J. Vanderlei Martins, Principal Investigator

OPAL: Dr. Charles Swenson, Principal Investigator, Utah State

Phoenix: Sarah Rogers, Project Manager, Arizona State University

SPACE HAUC: Supriya Chakrabarti, Principal Investigator, University of Massachusetts-Lowell

TechEdSat 8: Marcus Murbach, Project Manager, Ames Research Center

TJREVERB: Michael Piccione, Principal Investigator, Thomas Jefferson High School

UNITE: Glen Kissel, Principal Investigator, University of Southern Indiana

Virginia CubeSat Consortium (Aeternitas, Ceres, Libertas): Mary Sandy, Principal Investigator, Virginia Space Grant Consortium

Program Milestone Schedule	
Task	Date
CubeSat Selection	September 15, 2017
CubeSat Delivery to NanoRacks	August 20th, 2018
Launch	November 17 st , 2018

Figure 1: Program Milestone Schedule

The ELaNa-21 CubeSat complement will be launched as payloads on the OA-10 Antares launch vehicle to the International Space Station. The ELaNa-21 mission will deploy 13 pico-satellites (or CubeSats) from the International Space Station, using the NanoRacks CubeSat dispenser. Each CubeSat is identified in Table 2: ELaNa-21 CubeSats. The ELaNa-21 manifest includes: CapSat, CySat, HARP, KickSat-2, OPAL, Phoenix, SPACE HAUC, TechEdSat 8, TJREVERB, UNITE, and the three Virginia CubeSat Consortium CubeSats (Aeternitas, Ceres, and Libertas). The current launch date is projected to be November 17th, 2018.

The CubeSats on this mission range in size from a 10 cm cube to 60 cm x 10 cm x 10 cm, with masses from about 1.2 kg to 3.5 kg, with a total mass of roughly 20 kg being manifested on this mission. The CubeSats have been designed and universities and government agencies and each have their own mission goals.

Section 2: Spacecraft Description

There are 13 CubeSats flying on the ELaNa-21 Mission. Table 2: ELaNa-21 CubeSats outlines their generic attributes.

Table 2: ELaNa-21 CubeSats

CubeSat Names	CubeSat Quantity	CubeSat size (mm ³)	CubeSat Masses (kg)
CapSat	1	300 x 100 x 100	2.8
CySat	1	340 x 100 x 100	2.7
* HARP	1	368 x 100 x 100	4.1
* KickSat-2	1	300 x 100 x 100	2.3
* OPAL	1	368 x 100 x 100	5.0
Phoenix	1	325 x 100 x 100	3.2
SPACE HAUC	1	340 x 100 x 100	2.9
*TechEdSat 8	1	600 x 100 x 100	7.9
TJREVERB	1	227 x 100 x 100	2.6
UNITE	1	340 x 108 x 108	3.5
Virginia CC - Aeternitas	1	113 x 100 x 78	1.2
Virginia CC - Ceres	1	113 x 106 x 106	1.2
Virginia CC - Libertas	1	118 x 105 x 106	1.4

*The following pages describe the CubeSats flying on the ELaNa-21 mission, with the omissions noted below. ODARs for these CubeSats were previously submitted to the Agency as follows:

HARP: ELaNa-22 Rev A ODAR 5/2017

KickSat-2: KickSat-2 9/2015

OPAL: ELaNA-22 ODAR 10/2016

TechEdSat-8's ODAR was drafted by NASA Ames (Document No. T8MP-06-XS001 Rev 0)



Figure 2: CAPSat Expanded View

Overview

The Cooling, Pointing, Annealing Satellite (CAPSat) is a CubeSat under development by the University of Illinois and Bradley University. The mission, which is expected to last approximately one year, encompasses three technology demonstrations, each advancing the technology readiness level of NASA roadmap technologies. The experiments are: strain-actuated deployable panels for improved pointing control and jitter reduction, an active thermal control system, and single-photon avalanche detectors (SPADs) to test methods of mitigating space radiation damage.

CONOPS

Thirty minutes after all three separations switches register deployment, the power board will set a flag to initiate full boot. The C&DH will be brought online, and attempt to fire the thermal knives to release the antenna. After three attempts, it will begin a Bdot detumbling algorithm to attempt to reduce all angular motion. Beaconing will begin after the antenna has attempted deployment. Once we are able to uplink its TLE and a date stamp update, the ADCS algorithm will switch to controlling the satellite such that service plate is the ram. After a few weeks of commissioning and testing the payloads, science operations will begin. Data will be transmitted down on the NanoCom AX100 radio to our ground station. Science will continue until the satellite re-enters.

Materials

Satellite structure is made from AL60601T6, while the solar panels are Carbon fiber with an aluminum backing. The Cooling Payload consists of many small stainless steel components and its deployable panel is made of carbon fiber. The annealing payload is comprised of two circuit boards. The Pointing Payload is mostly circuit boards with an iron vibration motor and its deployable panel is made of a thin sheet of stainless steel.

Hazards

Regarding the restriction on pressure vessels for this launch, one of the CAPSat payloads contains a fluid loop containing 50/50 glycol/water, which under normal atmospheric conditions would not be considered a pressure vessel. The system has an operating pressure limit of 29.4 PSIA and a safety margin will be placed on the operating pressure of the system. The payload will undergo thorough leak and pressure testing in addition to standard vacuum, thermal, and vibration testing. There are no other hazards or exotic materials.

Power System/Batteries

The electrical power storage system consists of common lithium-ion batteries with over-charge/current protection circuitry. The charging system incorporates an MPPT logic. The lithium batteries carry the UL-listing number MH12210.

CySat – Iowa State University – 3U

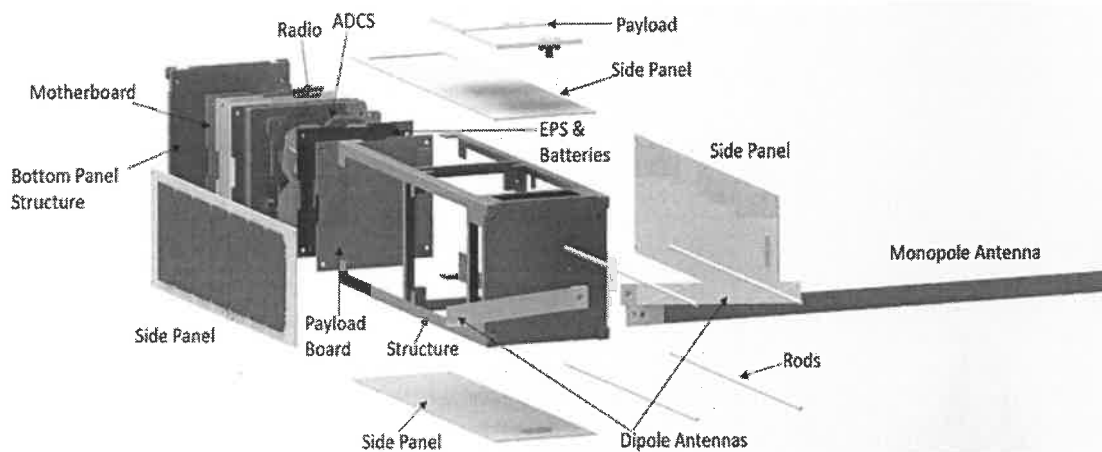

Figure 3: CySat Expanded View

Overview

CySat will operate in a Low Earth Orbit (LEO) environment to test out a state-of-the-art radiometer payload based off a Software Defined Radio (SDR) to observe the Earth and measure the soil moisture.

CONOPS

Once CySat is deployed power will begin flowing and the countdown timers for the deployable antenna and the communication subsystem will initiate. After 45 minutes have passed, the antenna will deploy. The ground station, will then attempt to pick up CySat's beacon and establish contact. The satellite will be in a passive mode at this point, and will stay in this mode for roughly the first 24 hours of operations. This involves an ASCII message containing minimal system status information and a welcome message for radio amateurs. A command will then be sent to CySat to ensure health and housekeeping data is gathered. This will continue for no more than a week. Once functions are determined to be nominal, CySat will be transitioned for primary operations and all primary payload routines will be active at this time. Payload activities are desired to continue for at least one year.

Materials

The CySat structure is made of Aluminum 6061-T6. It contains standard commercial off the shelf (COTS) materials, electrical components, PCBs and solar cells.

Hazards

There are no pressure vessels, hazardous or exotic materials.

Batteries

The electrical power storage system consists of Lithium ion batteries with cell overcurrent – charge, cell overcurrent – discharge, cell voltage and cell under – voltage protection circuits on each cell as well as on the entire battery assembly. Additional over – current bus protection and battery under – voltage protection is also provided by the electric power system (EPS). The UL – listing number for the batteries is: UL 1642.

Phoenix– Arizona State University – 3U

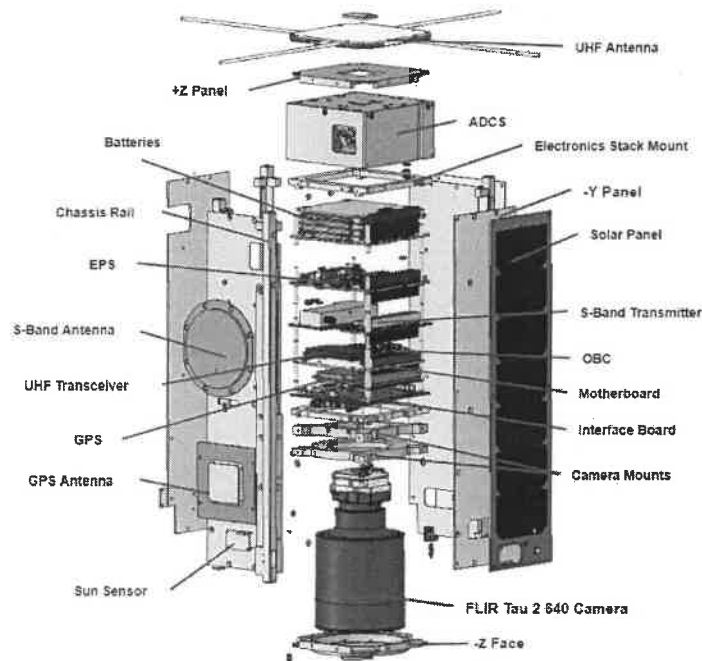

Figure 4: Phoenix Expanded View

Overview

Phoenix is a 3U CubeSat designed to study the Urban Heat Island Effect over several US cities. The payload is the Tau2 640 infrared camera, which is a commercially available, uncooled microbolometer produced by FLIR Technologies.

CONOPS

After the satellite is deployed from the ISS, it will initiate power to its components and start a countdown timer. After 30 minutes, the UHF antenna will deploy. After 45 minutes, the UHF beacon will be activated to communicate satellite health. Phoenix will undergo a week of checkout operations, where mission operators will monitor the health of the satellite, capture calibration images, and solidify the satellite's trajectory before beginning the mission objective. Mission operations are expected to last up to two years, and yield a total of 8,000 thermal IR images before the satellite re-enters.

Materials

Phoenix is comprised of COTS hardware. Therefore, all electrical components, PCBs, and solar cells are rated for the environment of space. The chassis is made of Aluminum 7075-T6. Stainless-steel bolts will be used to assemble the chassis and all cabling will be comprised of copper alloy material.

Hazards

There are no pressure vessels, hazardous, or exotic materials.

Batteries

The electrical power storage system consists of Lithium ion batteries with overcharge/current protection circuitry. The UL listing number for the batteries is: UL1642.

SPACE HAUC – University of Massachusetts, Lowell – 3U

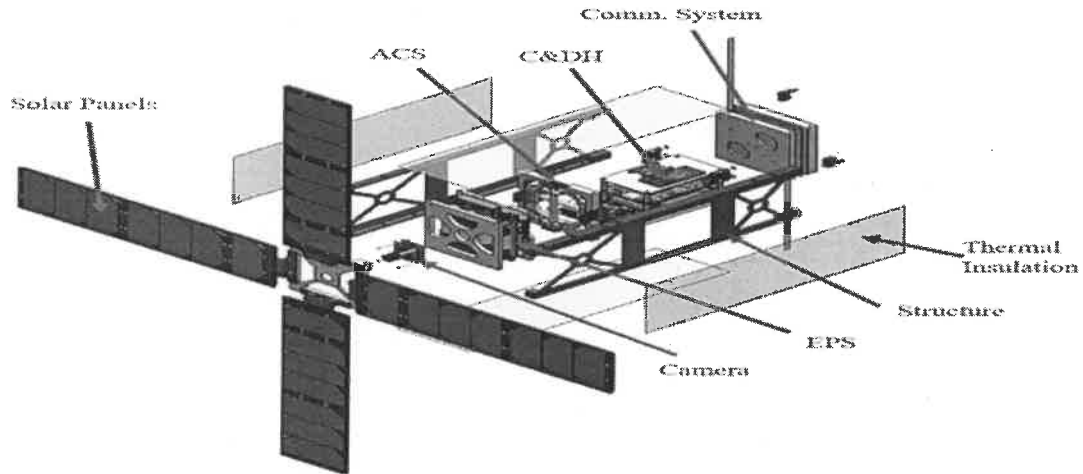

Figure 5: SPACE HAUC Expanded View

Overview

SPACE HAUC will demonstrate that high data transmission rates can be achieved by using a X-Band Phased-Array antenna with an electronically steered beam on a CubeSat.

CONOPS

Immediately upon deployment, SPACE HAUC will power up and determine if it is spin stabilized. If not, the Attitude Determination and Control System will stabilize the spin. It will then determine if it is sun pointed, if not the Attitude Determination and Control System will point SPACE HAUC at the sun. SPACE HAUC will then wait for a beacon signal from the ground, upon receipt of the beacon, SPACE HAUC will take pictures of the sun and transmit them down. The process of waiting for the beacon signal will be repeated whenever the beacon signal is lost.

Materials

The CubeSat structure is made of Aluminum 7075-T6. It contains all standard commercial off the shelf (COTS) materials, electrical components, PCBs and solar cells except for the RF front end board and patch antennas which are custom designed. The high-speed radio uses a ceramic patch antenna.

Hazards

There are no pressure vessels, hazardous, or exotic materials.

Batteries

The lithium-ion battery is charged with all the available power from the photo-voltaic inputs that is not drained by the loads on the external power busses. The battery is protected against voltage being too high or too low.

The software high voltage protection implements a constant voltage charge scheme that will keep the battery at its maximum voltage. The full mode regulation works by lowering voltage on the solar panel inputs, thereby only taking in the power needed.

The software low voltage protection is a four state system. Should the battery voltage drop below 7.2 V, the battery hardware will switch to a 'safe mode' configuration, which allows for the switching off of all essential systems and leaves only a simple power beacon running. Should the battery drop below 6.5 V, the software will switch off all user outputs.

TJREVERB – Thomas Jefferson High School for Science and Technology 2U

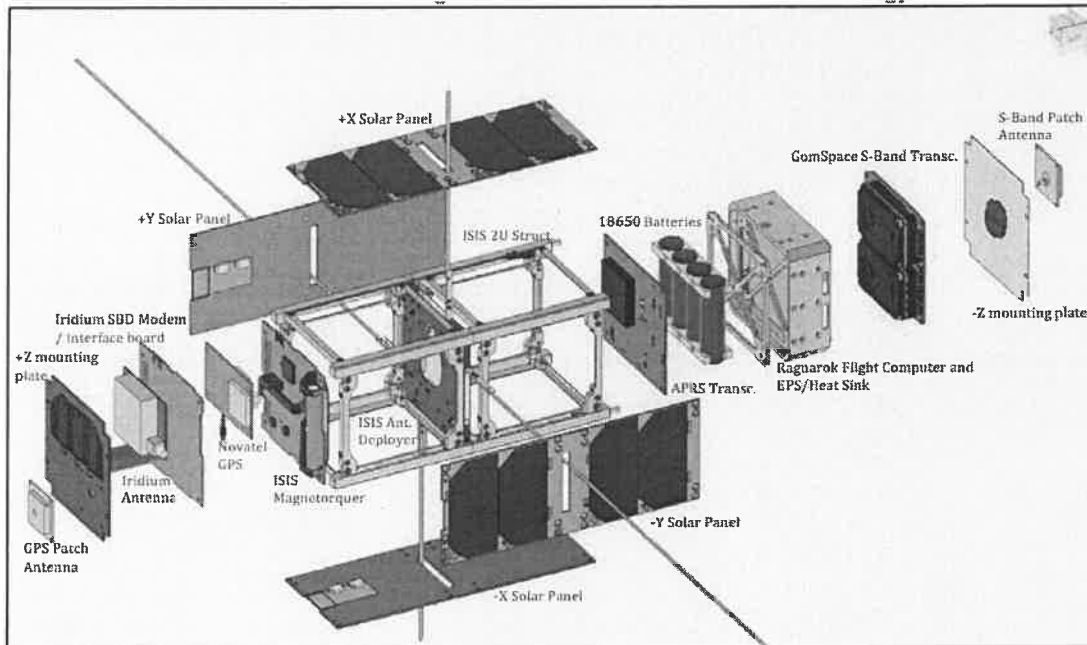

Figure 6: TJREVERB Expanded View

Overview

TJREVERB (Thomas Jefferson High School for Science and Technology Research and Education Vehicle for Evaluating Radio Broadcasts) will be a 2U CubeSat with magnetic torque control. It will be using a VHF APRS transceiver on 145.825MHz for command and control. It will also have a 2.2-2.3 GHz transceiver and a 1.616-1.6265 GHz short burst data (SBD) modem to test the ability to send and receive data packets and compare the usage of the Near Earth Network and the Iridium satellite network. The SBD modem will also provide secondary command and control.

CONOPS

Thirty mins after deployment, the spacecraft will deploy its antenna and start to detumble. After 45 mins the spacecraft establishes communications link, establish GPS link, clock synch, orbit determination daily, transmit AMSAT APRS signals, and perform operations modes (Charging, Comms check, and update) and science modes. Science modes consist of running various transmission activities while orbiting in various attitude orientations modes such as spin-stabilized and 3-axis regulation.

Materials

TJREVERB's chassis is made of Aluminum 606. It contains standard commercial off-the-shelf (COTS) materials, electrical components, PCBs and solar cells.

Hazards

TJREVERB does not include any hazardous systems or pressure vessels.

Batteries

The Orbtronics 18650B cell is a modified standard Panasonic 18650B NCR cell with UL listing MH12210 with flight heritage aboard past CubeSats such as GeneSat, SporeSat, OREOS, and Pharmasat. Each cell is 65 mm in length and 18.6 mm in diameter. The Graphite/LiNiCoAlO₂ (NCA) chemistry provides for maximum capacity of 3400 mAh at a full charge. A total of 40 Whr battery capacity is provided via 2 packs of 2 battery cells in series, @S2P, each at 20Whr.

Each cell contains a Positive Temperature Coefficient (PTC) device, Current Interrupt Device (CID), and an exhaust gas hole built into each battery cell to prevent cell rupture. The cell builds on the safety features of the 18650 cell by including a Seiko Protection Integrated Circuit (IC) that provides over voltage protections (OVP) at 4.35V, over-discharge (UVLO) protection (OCD) at 10-12A, and over-heating protection.

UNITE– University of Southern Indiana – 3U

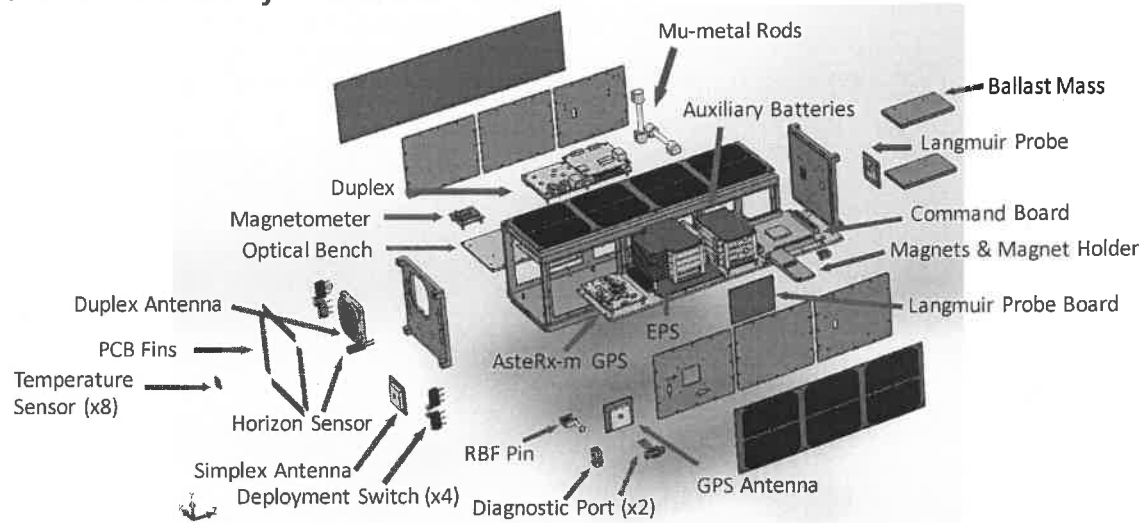

Figure 7: UNITE Expanded View

Overview

The Undergraduate Nano Ionospheric Temperature Explorer (UNITE) CubeSat is a 3U nanosatellite that will explore Low Earth Orbit until re-entry into the atmosphere around 90 km. The mission of UNITE is to conduct space weather measurements with a Langmuir plasma probe, measure interior and exterior temperature of the craft, and model the craft's orbit in the final hours of re-entry. The lower ionosphere is a relatively unexplored region of space and the scientific data collected and transmitted by UNITE will contribute to the understanding of the region.

CONOPS

Once deployed, the satellite's inhibit switches will be released. However, the satellite will not power on until the solar panels receive light. This is due to the "solar enable" feature of the EPS purchased from NearSpace Launch that acts as a third inhibit mechanism to the satellite powering on. Once powered on, no transmissions will be made for the first 45 minutes. Once this initial deployment period has passed, the satellite will begin collecting data and transmitting to the Globalstar satellite constellation. All transmission from UNITE will be to the Globalstar constellation as no ground station is used for the UNITE mission. The software of UNITE will change the rates of data collection and transmission based on the altitude. The satellite will continue to collect data and transmit until it burns up during re-entry.

Materials

The structure of UNITE is a 3U chassis made of anodized 6061 aluminum. External to the chassis are solar panels, consisting of PCB and glass covered solar cells, and ceramic patch antennae. The internal components of the satellite are commercial off the shelf

(COTS) materials, two 1/8' thick aluminum plates (optical benches in exploded view), copper ballast masses, electrical components, PCBs, and batteries.

Hazards

There are no pressure vessels, hazardous or exotic materials.

Batteries

There are four 2-cell lithium-polymer battery packs on UNITE, bringing the maximum total stored energy to 64 watt-hours. Each battery pack contains over-charge/current protection circuitry. The NearSpace Launch EPS that interfaces with the batteries also contains over-current and over-voltage protection. The UL listing number for the batteries is 30156-1.

Aeternitas – Old Dominion University (Virginia CubeSat Constellation)

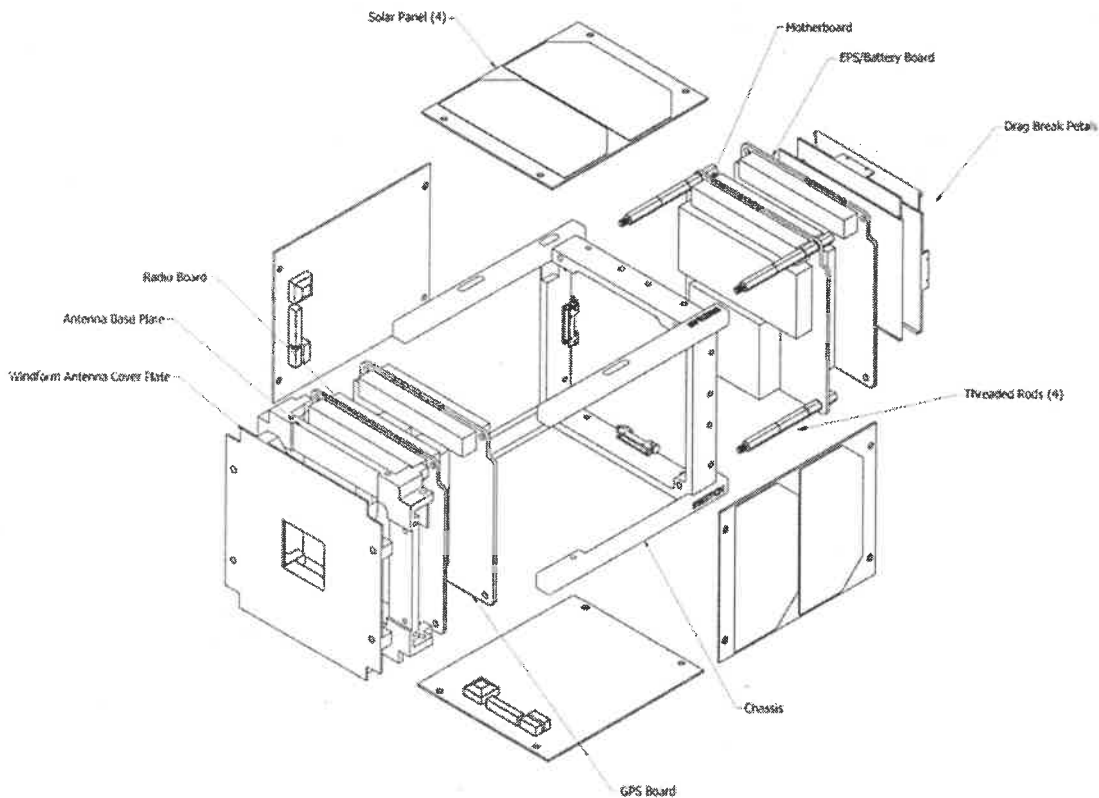

Figure 8: Aeternitas Expanded View

Overview

The Virginia CubeSat Constellation (VCC) mission is a joint operation between teams at Old Dominion University, University of Virginia, Virginia Tech, and Hampton University. ODU, UVA, and VT are each building 1U CubeSats (Aeternitas, Libertas, and Ceres, respectively) that will fly in low earth orbit. The universities are working collaboratively as each university builds its own 1U CubeSat and the data collected is to be shared between the three universities. The mission objectives are to provide undergraduate students with a hands-on flight project experience, to obtain data on atmospheric density and variability in LEO. A Hampton University student team will perform analysis of spacecraft attitude, location, and orbital data to measure variations in atmospheric density in low earth orbit. Differing from Libertas and Ceres, Aeternitas will deploy a petal-like drag brake (similar to a deployable solar panel array) and will deorbit at an accelerated rate for the purposes of providing additional atmospheric drag data.

CONOPS

After deployment from the NanoRacks deployer and remaining off for the required 30min, the antenna will deploy. Once enough power has been stored and the attitude has been determined, detumbling via magnetorquers will commence in short bursts. Once the

desired attitude stabilization is reached, Aeternitas will proceed with normal operations in which attitude and GPS data is recorded. The scientific data, and health updates will be downlinked to the ODU ground station during overflights. After initial data has been collected and downlinked, Aeternitas will deploy four drag brake petals that will remain connected to the satellite during de-orbit.

Materials

Aeternitas' chassis is made of Aluminum 6061-T6. It contains standard commercial off-the-shelf (COTS) materials, electrical components, PCBs and solar cells. The Aeternitas' payload includes a ceramic patch antenna and the cover plate for the antenna assembly will be printed from Windform.

Hazards

There are no pressure vessels, hazardous, or exotic materials.

Batteries

Aeternitas is using the GOMspace NanoPower P31u EPS which controls the charging and discharging of two 1-cell lithium-ion batteries. The EPS features under-voltage and over-voltage protection as well as over-current protection via power distribution switches.

Libertas –University of Virginia (Virginia CubeSat Constellation) – 1U

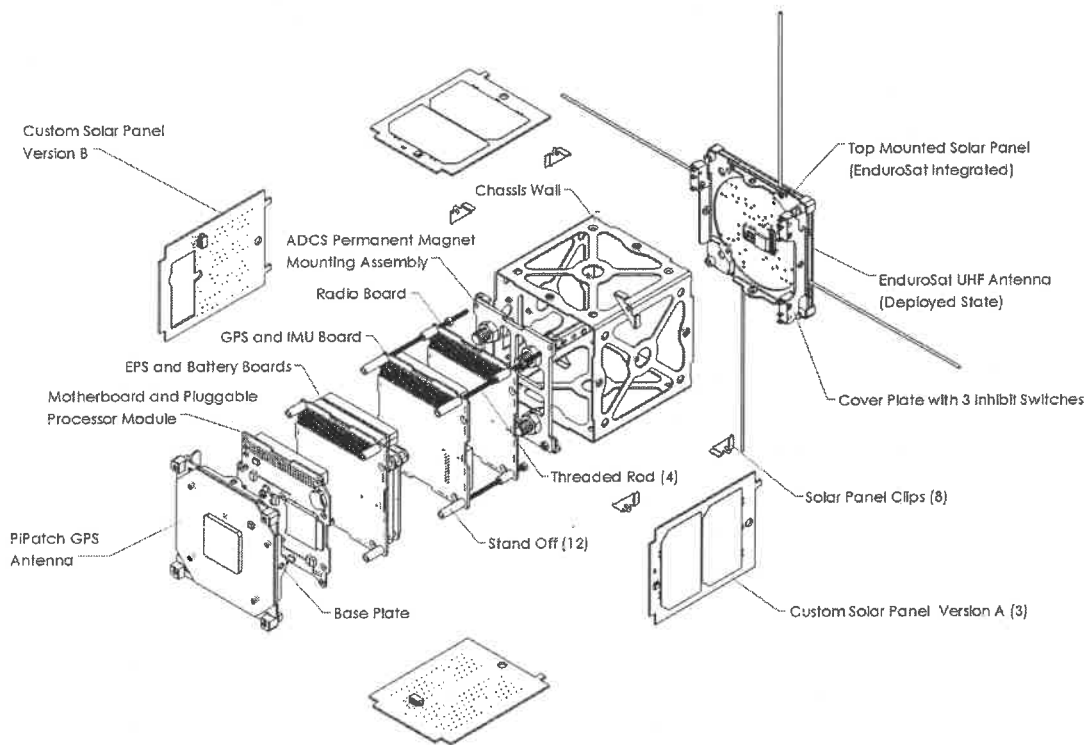

Figure 9: Libertas Expanded View

Overview

The Virginia CubeSat Constellation (VCC) mission is a joint operation between teams at Old Dominion University, University of Virginia, Virginia Tech, and Hampton University. ODU, UVA, and VT are each building 1U CubeSats (Aeternitas, Libertas, and Ceres, respectively) that will fly in low earth orbit. The universities are working collaboratively as each university builds its own 1U CubeSat and the data collected is to be shared between the three universities. The mission objectives are to provide undergraduate students with a hands-on flight project experience, to obtain data on atmospheric density and variability in LEO. A Hampton University student team will perform analysis of spacecraft attitude, location, and orbital data to measure variations in atmospheric density in low earth orbit.

CONOPS

Upon deployment from NanoRacks, Libertas will initiate a 30 minute countdown timer before powering up, as required by the NanoRacks deployer ICD. The satellite will enter a commissioning period in which the satellite has its initial power-up, deploys the UHF antenna if there is sufficient battery power available, and performs a system health check. The CubeSat will detumble using a passive magnetic attitude control system. Once the desired attitude stabilization is reached, Libertas will proceed with normal operations in

which attitude and GPS data is recorded. This data and health updates will be downlinked to the UVA ground station during overflights.

Material

The Pumpkin CubeSat Kit 1U chassis is constructed primarily from Aluminum 5052. Internal components are either commercial-off-the-shelf or fabricated from common materials such as custom PCBs and aluminum brackets inside the spacecraft for securing magnets used for PMAC and separation switches.

Hazards

There are no pressure vessels, hazardous, or exotic materials.

Power Systems/Hazards

The electrical power storage system will consist of a Clyde Space 3rd Generation.EPS and battery system that uses lithium-ion polymer cells with over-charge/current protection circuitry.

Ceres – Virginia Tech (Virginia CubeSat Constellation) – 3U

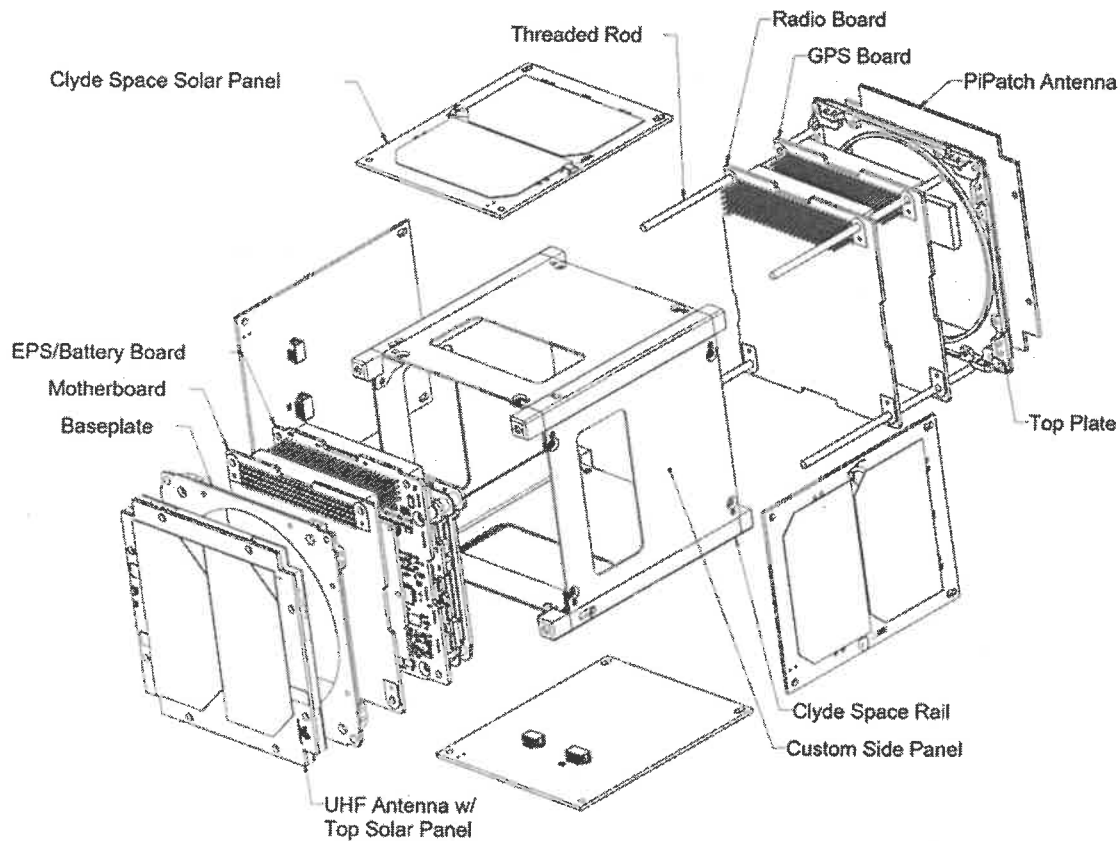

Figure 10: Ceres Expanded View

Overview

The Virginia CubeSat Constellation (VCC) mission is a joint operation between teams at Old Dominion University, University of Virginia, Virginia Tech, and Hampton University. ODU, UVA, and VT are each building 1U CubeSats (Aeternitas, Libertas, and Ceres, respectively) that will fly in low earth orbit. The universities are working collaboratively as each university builds its own 1U CubeSat and the data collected is to be shared between the three universities. The mission objectives are to provide undergraduate students with a hands-on flight project experience, to obtain data on atmospheric density and variability in LEO. A Hampton University student team will perform analysis of spacecraft attitude, location, and orbital data to measure variations in atmospheric density in low earth orbit.

CONOPS

Following deployment, Ceres will power up and start a countdown timer. After thirty minutes have passed, a UHF turnstile antenna will be deployed. For the first few passes the ground station operators will attempt communications to perform checkouts of the spacecraft. Following successful checkout, the primary science mission will begin and continue for at least 3 months. This includes recording attitude and GPS data. The scientific data, and health updates will be downlinked to the VT ground station during overflights.

Materials

The CubeSat rail structure and skeleton is made of Aluminum 5052-H32. Non-critical parts of the chassis are made of a 3D printed Ultem 1010 derivative with added carbon nanotubes, similar to GSC31264. It contains all standard commercial off the shelf (COTS) materials, electrical components, PCBs and solar cells.

Hazards

There are no pressure vessels, hazardous or exotic materials.

Batteries

The electrical power storage system consists of a Clyde Space 3rd Generation EPS and battery system that uses lithium-ion polymer cells with over-charge/current protection circuitry.

Section 3: Assessment of Spacecraft Debris Released during Normal Operations

The assessment of spacecraft debris requires the identification of any object (>1 mm) expected to be released from the spacecraft any time after launch, including object dimensions, mass, and material.

The section 3 requires rationale/necessity for release of each object, time of release of each object, relative to launch time, release velocity of each object with respect to spacecraft, expected orbital parameters (apogee, perigee, and inclination) of each object after release, calculated orbital lifetime of each object, including time spent in Low Earth Orbit (LEO), and an assessment of spacecraft compliance with Requirements 4.3-1 and 4.3-2.

No releases are planned on the ELaNa-21 CubeSat mission therefore this section is not applicable.

Section 4: Assessment of Spacecraft Intentional Breakups and Potential for Explosions.

There are NO plans for designed spacecraft breakups, explosions, or intentional collisions on the ELaNa-21 mission.

The probability of battery explosion is very low, and, due to the very small mass of the satellites and their short orbital lifetimes the effect of an explosion on the far-term LEO environment is negligible (ref (h)).

The CubeSats batteries still meet Req. 56450 (4.4-2) by virtue of the HQ OSMA policy regarding CubeSat battery disconnect stating;

“CubeSats as a satellite class need not disconnect their batteries if flown in LEO with orbital lifetimes less than 25 years.” (ref. (h))

Limitations in space and mass prevent the inclusion of the necessary resources to disconnect the battery or the solar arrays at EOM. However, the low charges and small battery cells on the CubeSat’s power system prevents a catastrophic failure, so that passivation at EOM is not necessary to prevent an explosion or deflagration large enough to release orbital debris.

The 6U CubeSat in this complement satisfy Requirements 4.4-1 and 4.4-2 if their batteries are equipped with protection circuitry, and they meet International Space Station (ISS) safety requirements for secondary payloads. Additionally, these CubeSats are being deployed from a very low altitude (ISS orbits at approximately 400 km), meaning any accidental explosions during mission operations or post-mission will have negligible long-term effects to the space environment.

Assessment of spacecraft compliance with Requirements 4.4-1 through 4.4-4 shows that with a maximum CubeSat lifetime of 3.9 years maximum, the ELaNa-21 CubeSats are compliant.

Section 5: Assessment of Spacecraft Potential for On-Orbit Collisions

Calculation of spacecraft probability of collision with space objects larger than 10 cm in diameter during the orbital lifetime of the spacecraft takes into account both the mean cross sectional area and orbital lifetime.

The largest mean cross sectional area (CSA) among the 13 CubeSats is that of the SPACE HAUC CubeSat with solar arrays deployed.

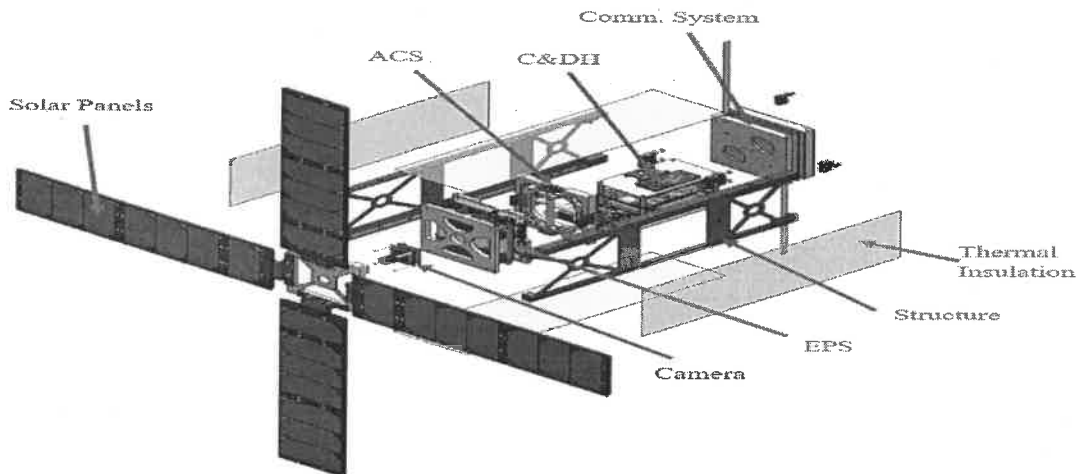

Figure 10: SPACE HAUC Expanded View (with solar panels deployed)

$$\text{Mean CSA} = \frac{\sum \text{Surface Area}}{4} = \frac{[2 * (w * l) + 4 * (w * h)]}{4}$$

Equation 1: Mean Cross Sectional Area for Convex Objects

$$\text{Mean CSA} = \frac{(A_{max} + A_1 + A_1)}{2}$$

Equation 2: Mean Cross Sectional Area for Complex Objects

All CubeSats evaluated for this ODAR are stowed in a convex configuration, indicating there are no elements of the CubeSats obscuring another element of the same CubeSats from view. Thus, the mean CSA for all stowed CubeSats was calculated using Equation 1. This configuration renders the longest orbital life times for all CubeSats.

Once a CubeSat has been ejected from the NanoRacks dispenser and deployables have been extended, Equation 2 is utilized to determine the mean CSA. A_{max} is identified as the view that yields the maximum cross-sectional area. A_1 and A_2 are the two cross-sectional areas orthogonal to A_{max} . Refer to Appendix A for component dimensions used in these calculations

The SPACE HAUC (2.9 kg) orbit at deployment is 408 km apogee altitude by 400 km perigee altitude, with an inclination of 51.6 degrees. With an area to mass ratio of 0.00398 m²/kg, DAS yields 3.9 years for orbit lifetime for its stowed state, which in turn

is used to obtain the collision probability. Even with the variation in CubeSat design and orbital lifetime ELaNa-21 CubeSats see an average of 0.0 probability of collision. All CubeSats on ELaNa-21 were calculated to have a probability of collision of 0.0. Table 3 below provides complete results.

There will be no post-mission disposal operation. As such the identification of all systems and components required to accomplish post-mission disposal operation, including passivation and maneuvering, is not applicable.

Table 3: CubeSat Orbital Lifetime & Collision Probability

CubeSat		CapSat	CySat	Phoenix	SPACE HAUC	TechEdSat 8
Mass (kg)		2.8	2.7	3.2	2.9	7.9

Stowed						
Mean C/S Area (m ²)	0.0371	0.027	0.015	0.0116	0.104	
Area-to Mass (m ² /kg)	0.0133	0.014	0.012	0.004	0.0132	
Orbital Lifetime (yrs)	2.5	2.3	3.7	3.9	2.2	
Probability of collision (10 ⁴ X)	0.00000	0.00000	0.00000	0.00000	0.00000	0.00000

Deployed **						
Mean C/S Area (m ²)	0.1263			0.0709	0.564	
Area-to Mass (m ² /kg)	0.0454			0.0243	0.0714	
Orbital Lifetime (yrs)	0.62			1.09	0.482	
Probability of collision (10 ⁴ X)	0.00000			0.00000	0.00000	0.00000

Solar Flux Table Dated
8/14/2017

**Note: Blacked out areas represent
CubeSats which do not have
deployables or have deployable
antennae with negligible areas with
respect to on-orbit dwell time
calculation. Data for TechEdSat-8
taken from Ames-submitted ODAR
report.

Table 4: CubeSat Orbital Lifetime & Collision Probability

CubeSat		TJREVERB	UNITE	Aeternitas	Ceres	Libertas
Mass (kg)		2.6	3.5	1.2	1.2	1.4
Stowed	Mean C/S Area (m ²)	0.085	0.079	0.0163	0.0176	0.0182
	Area-to Mass (m ² /kg)	0.0327	0.0225	0.0136	0.0147	0.0130
	Orbital Lifetime (yrs)	0.77	1.2	2.3	2.0	2.4
	Probability of collision (10 ⁶ X)	0.00000	0.00000	0.00000	0.00000	0.00000

Deployed **				0.0398		
Mean C/S Area (m ²)				0.0333		
Area-to Mass (m ² /kg)				0.75		
Orbital Lifetime (yrs)				0.0000		
Probability of collision (10 ⁶ X)						

Table 3: CubeSat Orbital Lifetime & Collision Probability (cont.)

The probability of any ELaNa-21 spacecraft collision with debris and meteoroids greater than 10 cm in diameter and capable of preventing post-mission disposal is less than 0.00000, for any configuration. This satisfies the 0.001 maximum probability requirement 4.5-1.

The VCC CubeSat Aeternitas will deploy a petal-like drag brake, for the purpose of providing data regarding drag effects upon its orbit. This feature does not increase the probability of on-orbit collision. The ELaNa-21 CubeSats have no capability or plan for end-of-mission disposal, therefore requirement 4.5-2 is not applicable.

In summary, assessment of spacecraft compliance with Requirements 4.5-1 shows ELaNa-21 to be compliant. Requirement 4.5-2 is not applicable to this mission.

Section 6: Assessment of Spacecraft Post Mission Disposal Plans and Procedures

All ELaNa-21 spacecraft will naturally decay from orbit within 25 years after end of the mission, satisfying requirement 4.6-1a detailing the spacecraft disposal option.

Planning for spacecraft maneuvers to accomplish post-mission disposal is not applicable. Disposal is achieved via passive atmospheric reentry.

Calculating the area-to-mass ratio for the worst-case (smallest Area-to-Mass) post-mission disposal among the CubeSats finds SPACE HAUC in its stowed configuration as the worst case. The area-to-mass is calculated for is as follows:

$$\frac{\text{Mean } C/S \text{ Area } (m^2)}{\text{Mass } (kg)} = \text{Area - to - Mass } \left(\frac{m^2}{kg}\right)$$

Equation 3: Area to Mass

$$\frac{0.0116 m^2}{2.9 kg} = 0.004 \frac{m^2}{kg}$$

SPACE HAUC has the smallest Area-to-Mass ratio and as a result will have the longest orbital lifetime. The assessment of the spacecraft illustrates they are compliant with Requirements 4.6-1 through 4.6-5.

DAS 2.1.1 Orbital Lifetime Calculations:

DAS inputs are: 408 km maximum apogee 400 km maximum perigee altitudes with an inclination of 51.6° at deployment no earlier than April 2018. An area to mass ratio of ~0.004 m²/kg for the SPACE HAUC CubeSat was used. DAS 2.1.1 yields a 3.9 years orbit lifetime for SPACE HAUC in its stowed state.

This meets requirement 4.6-1. For the complete list of CubeSat orbital lifetimes reference **Table 4: CubeSat Orbital Lifetime & Collision Probability**.

Assessment results show compliance.

Section 7: Assessment of Spacecraft Reentry Hazards

A detailed assessment of the components to be flown on ELaNa-21 was performed. (Data provided for TechEdSat-8 in their submitted ODAR report was reviewed as well). The assessment used DAS 2.1.1, a conservative tool used by the NASA Orbital Debris Office to verify Requirement 4.7-1. The analysis is intended to provide a bounding analysis for characterizing the survivability of a CubeSat's component during re-entry. For example, when DAS shows a component surviving reentry it is not taking into account the material ablating away or charring due to oxidative heating. Both physical effects are experienced upon reentry and will decrease the mass and size of the real-life components as the reenter the atmosphere, reducing the risk they pose still further.

An assessment of the components flown on TechEdSat-8 is contained in Reference J.

The following steps are used to identify and evaluate a components potential reentry risk relative to the 4.7-1 requirement of having less than 15 J of kinetic energy and a 1:10,000 probability of a human casualty in the event the survive reentry.

1. Low melting temperature (less than 1000 °C) components are identified as materials that would never survive reentry and pose no risk to human casualty. This is confirmed through DAS analysis that showed materials with melting temperatures equal to or below that of copper (1080 °C) will always demise upon reentry for any size component up to the dimensions of a 1U CubeSat.
2. The remaining high temperature materials are shown to pose negligible risk to human casualty through a bounding DAS analysis of the highest temperature components, stainless steel (1500°C). If a component is of similar dimensions and has a melting temperature between 1000 °C and 1500°C, it can be expected to possess the same negligible risk as stainless steel components.

Table 4: ELaNa-21 High Melting Temperature Material Analysis

CubeSat	Name	Material	Total Mass (kg)	Demise Alt (km)	Kinetic Energy (J)
CAPSat	Antennae	Stainless Steel	.0176	0	0
CAPSat	Pointing Panel	301 Stainless Steel	.0382	0	10
CAPSat	Face Seal Edge Connector	316 Stainless Steel	.0093	77.5	0
CAPSat	Gear Pump	316 Stainless Steel	.110	68.6	0
CAPSat	Bellows Accumulator	316 Stainless Steel	.218	63.8	0
CAPSat	Pressure Sensors	316 Stainless Steel	.079	70.3	0
CAPSat	Radiator Panel Hinge	Unfinished Steel	.0068	76.5	0
CAPSat	Radiator Board Standoffs	18-8 Stainless Steel	.0055	73.8	0
CAPSat	Pipe Fittings	Stainless Steel (generic)	various	75.2	0
CySat	Rods	Stainless Steel (generic)	.080	0	0
CySat	Standoffs	Stainless Steel (generic)	.084	72.8	0

CySat	Fasteners	Stainless Steel (generic)	.040	77.0	0
CySat	Separation Switches	Stainless Steel (generic)	.028	0	0
CySat	RBF Pin	Stainless Steel (generic)	.017	74.7	0
CySat	Separation Springs	Stainless Steel (generic)	.0002	77.3	0
CySat	Reaction Wheel	Brass	.060	73.1	0
CySat	Magnetometer	Aluminum	.005	77.3	0
CySat	Deployable Magnetometer	Brass	.002	77.8	0
Phoenix	Screws	Stainless Steel (generic)	6.94	77.7	0
Phoenix	Nuts	Stainless Steel (generic)	3.92	77.6	0
Phoenix	Electronics Stack Rod	Stainless Steel (generic)	4.29	76.8	0
Phoenix	Separation Springs	Stainless Steel (generic)	0.072	77.9	0
SPACE HAUC	Torsion Spring	Steel (AISI 304)	.00015	77.9	0
SPACE HAUC	4-40 Screws	Steel (AISI304)	.004	76.2	0
SPACE HAUC	Spacer RF Boards	Steel (AISI 304)	.004	76.5	0
TJREVERB	Standoff screws	Stainless Steel (generic)	.020	77.7	0
TJREVERB	6 mm screws	Stainless Steel (generic)	.064	77.5	0
UNITE	External Fasteners	Stainless Steel (generic)	.020	77.6	0
UNITE	Magnet Holder	Lexan	.010	78.0	0
UNITE	Mu-Metal Rod	HyMu80 (nickel alloy)	.047	71.4	0
UNITE	Internal Fasteners	Stainless Steel (generic)	.0002	77.9	0
Virginia CC: Aeternitas	Antenna Blades	Steel/copper plate	.0005	0	0
Virginia CC: Ceres	Separation Switches	Beryllium Copper	.003	0	0
Virginia CC: Ceres	Solar Panel Retaining Clips	Stainless Steel	.001	0	0
Virginia CC: Ceres	Magnet Mounting Plates	Aluminum	.050	0	0
Virginia CC: Libertas	Separation Switches	Beryllium Copper	.003	0	0

The majority of stainless steel components demise upon reentry and all CubeSats comply with the 1:10,000 probability of Human Casualty Requirement 4.7-1. A breakdown of the determined probabilities follows:

Table 5: Requirement 4.7-1 Compliance by CubeSat

Name	Status	Risk of Human Casualty
CapSat	Compliant	1:0
CySat	Compliant	1:0
SPACE HAUC	Compliant	1:0
TechEdSat-8	Compliant	1:0
TJREVERB	Compliant	1:0
UNITE	Compliant	1:0
Virginia CC:Aeternitas	Compliant	1:0
Virginia CC:Ceres	Compliant	1:0
Virginia CC:Libertas	Compliant	1:0

*Requirement 4.7-1 Probability of Human Casualty > 1:10,000

If a component survives to the ground but has less than 15 Joules of kinetic energy, it is not included in the Debris Casualty Area that inputs into the Probability of Human Casualty calculation. This is why all of the ELaNa-21 CubeSats have a 1:0 probability as none of their components have more than 15J of energy.

All CubeSats launching under the ELaNa-21 mission are shown to be in compliance with Requirement 4.7-1 of NASA-STD-8719.14A.

Section 8: Assessment for Tether Missions

ELaNa-21 CubeSats will not be deploying any tethers.

ELaNa-21 CubeSats satisfy Section 8's requirement 4.8-1.

Section 9-14

ODAR sections 9 through 14 pertain to the launch vehicle, and are not covered here. Launch vehicle sections of the ODAR are the responsibility of the CRS provider.

If you have any questions, please contact the undersigned at 321-867-2098.

/original signed by/

Yusef A. Johnson
Flight Design Analyst
a.i. solutions/KSC/AIS2

cc: VA-H/Mr. Carney
VA-H1/Mr. Beaver
VA-H1/Mr. Haddox
VA-C/Mr. Higginbotham
VA-C/Mrs. Nufer
VA-G2/Mr. Treptow
SA-D2/Mr. Frattin
SA-D2/Mr. Hale
SA-D2/Mr. Henry
Analex-3/Mr. Davis
Analex-22/Ms. Ramos

Appendix Index:

Appendix A.	ELaNa-21 Component List by CubeSat: CAPSat
Appendix B.	ELaNa-21 Component List by CubeSat: CySat
Appendix C.	ELaNa-21 Component List by CubeSat: Phoenix
Appendix D.	ELaNa-21 Component List by CubeSat: SPACE HAUC
Appendix E.	ELaNa-21 Component List by CubeSat: TJREVERB
Appendix F.	ELaNa-21 Component List by CubeSat: UNITE
Appendix G.	ELaNa-21 Component List by CubeSat: Virginia CC: Aeternitas
Appendix H.	ELaNa-21 Component List by CubeSat: Virginia CC: Ceres
Appendix I.	ELaNa-21 Component List by CubeSat: Virginia CC: Libertas
Appendix J.	ELaNa-21 TechEdSat-8 ODAR (produced by NASA-Ames)

Appendix A: ELaNu-21 Component List by CubeSat: Capsat

Item Number	Name	Qty	Material	Body Type	Mass (g) (total)	Diameter / Width (mm)	Length (mm)	Height (mm)	High Temp	Melting Temp (F°)	Survivability
1	Rail	4	Aluminum 6061	Rail	50.8	17	17	100	No	-	Demise
2	Bottom Plate	1	Aluminum 6061	Plate	110.6	100	100	100	No	-	Demise
3	Antennae	4	Stainless Steel	Strip	4.4	6.7	22	100	Yes	2642°	0 km
4	Short Radiation Shielding	2	Carbon Fiber	Plate	38.7	80	284.3	100	No	-	Demise
5	Tall Radiation Shielding	1	Carbon Fiber	Plate	44.5	80	327	76	No	-	Demise
6	Radiation Shielding with Access Port	1	Carbon Fiber	Plate	44.2	80	327	20	No	-	Demise
7	Solar Cell	25	Solar Cell	Panel	3.2	40	70	N/D	No	-	Demise
8	Short Flex Cable	2	Kapton and PCB Components	Flat Cable	4.1	54	18.34	N/D	No	-	Demise
9	Tall Flex Cable	2	Kapton and PCB Components	Flat Cable	4.5	54	18.34	N/D	No	-	Demise
10	Top Plate	1	Aluminum 6061	Plate	76.3	100	100	90.17	No	-	Demise
11	Middle Plate	1	Aluminum 6061	Plate	65.3	93.65	93.65	46	No	-	Demise
12	Bateries	4	Lithium-Ion battery chemistry	Cylinder	46.1	18.4	65	90	No	-	Demise
13	Battery Support Plate	1	Aluminum 6061	Plate	25.2	86	86	33.02	No	-	Demise
14	Magnetometer	4	Circuit Board	Board	3.7	40	30	90.17	No	-	Demise
15	Daughter Card	1	Circuit Board	Plate	10.1	60	30	90	No	-	Demise
16	Power Board	1	Circuit Board	Board	56.5	94	90	70	No	-	Demise
17	C&DH Board (was CPU)	1	Circuit Board	Board	40	90	90	90	No	-	Demise
18	Torque Coil	6	FR-4	Plate	52.218	86	76.2	90.17	No	-	Demise
19	Torque Coil Plate	1	Aluminum 6061	Plate	17.8	74	74	87	No	-	Demise
20	GOMSpace Radio	2	Aluminum 6061 and Circuit Board	Plate	24.5	65	40	31.75	No	-	Demise
21	Radio Carry Board	2	Circuit Board	Board	19.1	60	90	40	No	-	Demise
22	Pointing Panel	1	301 Stainless Steel	Panel	128	80	326.5	14.7	Yes	2800 °	0 km
23	Strain gauge	8	Silicon	Board	2	7.5	10.8	6.5	No	-	Demise

24	PL140 Bending Actuator	4	Piezoelectric Ceramic (PIC 252)	Board	2.1	11.2	45.5	15.5	No	-	Demise
25	L-bracket	2	Aluminium 6061	Board	4.67	17	39.454	51.64	No	-	Demise
26	Shaft	1	Aluminium 6061	Board	2.54	7.071	44	N/D	No	-	Demise
27	Q-614 Rotary Actuator	2	Piezoelectric Ceramic	Board	9	17.91	17.5	N/D	No	-	Demise
28	Circuit Board	3	Circuit Board	Board	20	46.5	91.5	N/D	No	-	Demise
29	Standoffs	12	Aluminium 6061	Hexagonal Cylinder	1.637	5.2		N/D	No	-	Demise
30	Vibration Motor	1	Cast Iron	Board	88	32	32	8.26	No	-	Demise
31	Carbon Fiber Radiator Panel with Thermal Control Coating	1	Carbon Fiber Composite	Plate	62.6	80	327	1.5	No	-	Demise
32	Face-Seal Edge Connector	2	316 Stainless Steel	Rectangular Prism	4.66	9.53	12.70	19	Yes	2500°	Demise
33	Gear Pump	1	316 Stainless Steel	Cylinder	110.00	31.90	60.67	32	No	2500°	Demise
34	Water Block Heat Exchanger	1	Aluminium 6061	Rectangular Prism	17.00	25.30	25.30	1.2	No	-	Demise
35	Bellows-Accumulator	1	316 Stainless Steel	Hollow Cylinder	218.00	43.94	29.85	5.00	No	2500°	Demise
36	Pressure Sensors	2	316 Stainless Steel	Cylinder	39.70	18.90	31.00	N/A	No	2500°	Demise
37	Radiator Control Board	1	Circuit Board	Board	49.89	93.65	85.25	12.40	No	-	Demise
38	Kapton Heater	1	Kapton	Sheet	0.23	25.30	25.30	N/A	No	-	Demise
39	Radiator Panel Hinge	2	Unfinished Steel	Plate	3.44	32.00	18.40	N/A	No	2500°	Demise
40	Cooling - Top Plate	1	Aluminium 6061	Plate	61.71	93.65	93.65	1.60	No	-	Demise
41	Cooling - Bottom Plate	1	Aluminium 6061	Plate	75.26	93.65	93.65	0.25	No	-	Demise
42	Cooling - Back Plate	1	Aluminium 6061	Plate	32.79	47.50	93.65	0.60	No	-	Demise
43	Cooling - Side Plate 1	1	Aluminium 6061	Plate	24.62	47.50	91.15	2.50	No	-	Demise
44	Cooling - Side Plate 2	1	Aluminium 6061	Plate	23.06	47.50	91.15	2.50	No	-	Demise
45	Loop Clamp	2	Aluminium 6061	Bent Sheet Metal (in half-circle)	0.75	16.60	6.50	2.50	No	-	Demise
46	Hex Clamp	2	Aluminium 6061	Bent Sheet Metal (in half-hexagon)	0.60	9.00	20.77	2.50	No	-	Demise

47	Bellows Clamp	4	Aluminum 6061	Bent Sheet Metal	0.52	5.00	46.39	2.50	No	-	Demise
48	Bellows Ring Clamp	1	Aluminum 6061	Cylinder	1.49	22.00	2.66	0.80	No	-	Demise
49	Radiator Board Standoffs	4	18-8 Stainless Steel	Hexagonal Cylinder	1.38	4.50	12.00	0.80	No	-	Demise
50	Pipe Fitting - MCB-1016-316	4	316 Stainless Steel	Hexagonal Cylinder	4.37	7.92	15.37	0.80	No	2500°	Demise
51	Pipe Fitting - MBV-1010	1	316 Stainless Steel	Rectangular Prism	10.43	13.34	17.90	N/A	No	2500°	Demise
52	Pipe Fitting - MTS-1010	1	316 Stainless Steel	Rectangular Prism	7.59	7.94	15.88	N/A	No	2500°	Demise
53	Pipe Fitting - SMCBT-1016	2	316 Stainless Steel	Rectangular Prism	9.25	7.92	32.77	N/A	No	2500°	Demise
54	Pipe Fitting - MPFA-1810	2	316 Stainless Steel	Cylinder	13.52	13.97	14.48	7.92	No	2500°	Demise
55	Pipe Fitting - SS-100-1-2RT	2	316 Stainless Steel	Hexagonal Cylinder	12.37	11.11	26.24	8.00	No	2500°	Demise
56	Pipe Fitting - SS-100-1-1	2	316 Stainless Steel	Hexagonal Cylinder	8.39	7.87	23.88	7.92	No	2500°	Demise
57	Pipe Fitting - MF-1010	2	316 Stainless Steel	Hexagonal Cylinder	3.07	7.94	9.12	N/A	No	2500°	Demise
58	Pipe Fitting - MH-1031-316	2	316 Stainless Steel	Hexagonal Cylinder	2.52	7.94	8.66	N/A	No	2500°	Demise
59	Pipe Fitting - SS-100-3	1	316 Stainless Steel	Rectangular Prism	20.48	22.56	35.56	N/A	No	2500°	Demise
60	Pipe Fitting - CF-316-05-316-E	1	316 Stainless Steel	Hexagonal Cylinder	2.77	7.94	10.80	N/A	No	2500°	Demise
61	Metal Tubing - Segment 1	1	316 Stainless Steel	Bent Tubing	0.64	1.59	46.30	N/A	No	2500°	Demise
62	Metal Tubing - Segment 2	1	316 Stainless Steel	Bent Tubing	0.32	1.59	23.21	9.53	No	2500°	Demise
63	Metal Tubing - Segment 3	1	316 Stainless Steel	Bent Tubing	0.20	1.59	14.77	N/A	No	2500°	Demise
64	Metal Tubing - Segment 4	1	316 Stainless Steel	Bent Tubing	0.49	1.59	35.27	N/A	No	2500°	Demise
65	Metal Tubing - Segment 5	1	316 Stainless Steel	Bent Tubing	0.53	1.59	38.22	N/A	No	2500°	Demise
66	Metal Tubing - Segment 6	1	316 Stainless Steel	Bent Tubing	0.53	1.59	38.22	N/A	No	2500°	Demise
67	Metal Tubing - Segment 7	1	316 Stainless Steel	Bent Tubing	0.90	1.59	65.14	N/A	No	2500°	Demise
68	Metal Tubing - Segment 8	1	316 Stainless Steel	Bent Tubing	0.67	1.59	48.38	N/A	No	2500°	Demise
69	Flexible Tubing - Segment 1	2	Teflon	Bent Tubing	0.40	1.59	121.25	N/A	No	-	Demise
70	Multimode Optic Fiber	2	Fiberglass	Bent Tubing	0.019	0.125	150	N/A	No	-	Demise
71	Photodiode	4	Silicon	Cylinder	0.018	1.02	2.41	N/A	No	-	Demise

Appendix B. ELaN-21 Component List by CubeSat: CySat

Item Number	Name	Qty	Material	Body Type	Mass (g) (total)	Diameter/Width (mm)	Length (mm)	Height (mm)	High Temp	Melting Temp (F°)	Survivability
1	CubeSat Structure	1	Aluminum 6061	Box	500	10	10	340.5	No	-	Dennise
2	Rods	4	18-8 Stainless Steel	Cylinder	20	3	340.5	---	Yes	2650°	0 km
3	Standoffs	28	18-8 Stainless Steel	Hollow Cylinder	3	6	15	---	No	2650°	Dennise
4	Fasteners (2M)	50	18-8 Stainless Steel	Screw	0.8	2	5	---	No	2650°	Dennise
5	Separation Switches	4	Thermoplastic/Stainless Steel	Box	7	3.378	20	12.268	No	2550°	0 km
6	RBF Pin	1	Stainless Steel	Pin	17	4.67	22.6	---	No	2550°	Dennise
7	Separation Springs	2	316 Stainless Steel	Cylinder	0.1	2.843	5.258	---	No	2650°	Dennise
8	Reaction Wheel	1	Brass (flywheel), Alucoat 650 coated Aluminum (housing)	Box	60	28	28	26.2	No	1724°	Dennise
9	Magnetometer - Deployment & Shell	1	Alucoat 650 coated Aluminum	Box	5	83.3	16.8	6.5	No	-	Dennise
10	Deployable Magnetometer - Boom	1	Brass	Box	2	83.3	16.8	6.5	No	1724°	Dennise
11	Course Sun Sensor	6	FR4 - Elpemer AS 2467	Box	1	3.7	10.8	1.5	No	-	Dennise
12	CubeTorquer (magnetorquer)	2	Supra 50 (Core), Alucoat 650 Aluminum (caps), Enamel coated copper (windings)	Cylinder with box caps	28	13.5	60	18	No	-	Dennise
13	Cubecoil (magnetorquer)	1	Alucoat 650 Aluminum (body), Enamel coated copper (windings)	Plate	46	90	96	8	No	-	Dennise
14	Cube Sense (fine sun sensor & nadir sensor, PCB)	1	FR4 - Elpemer AS 2467	Plate	80	90	96	35	No	-	Dennise
15	CubeComputer (ADCS computer)	1	FR4 - Elpemer AS 2467	Plate	56	90	96	10	No	-	Dennise
16	Cubecontrol	1	FR4 - Elpemer AS 2467	Box	60	90	96	30	Yes	-	Dennise
17	Battery	1	Lithium-Ion Polymer	Box	111.15	90.17	95.89	14	Yes	-	Dennise

18	Electronic Power System (EPS)	1	PCB Material (FR4)	Box	126.9	90.17	95.89	12.4	No	-	Dennise
19	Solar Panels		PCB Material (FR4)	Rectangle	approx	varies	varies	1.6	No	-	Dennise
20	XTJ Prime Solar Cells	1	-	Box	2.27	6.91	3.97	0.225	No	-	Dennise
21	TrosolX Solar Wing Solar Cells		-	Rectangle	0.75	26.3	10	0.01	No	-	Dennise
22	Primary Radio	6	Aluminum 6082	Rectangle	90	90.18	95.89	14.56	No	-	Dennise
23	PCB	28	FR-4 Substrate	Rectangle	54	96.52	90.17	1.6	No	-	Dennise
24	Microcontroller - STM32F411RC6	12	Silica(Amorphous)/A	Triangle	0.3570 2	12	12	1.6	No	-	Dennise
25	Memory	1	Silica(Amorphous)/A	Box	0.54	8.26	5.33	2.03	No	-	Dennise
26	Linear Voltage Regulator - AP7313	1	Silica(Amorphous)/A	Box	0.008	2.4	2.9	1.025	No	-	Dennise
27	Buffer - SN74LS125ADR	2	Silica(Amorphous)/A	Box	0.129	8.2	10.5	2	No	-	Dennise
28	Buffer - PCA9517AD118	4	Silica(Amorphous)/A	Integrated Circuit	0.0745	6.2	5	1.75	No	-	Dennise
29	Software-Defined Radio	1	copper Rogers 4003, FR4 370HR, stainless steel, etc.	Integrated Circuit	260	100	61.97	1.27	No	-	Dennise
30	Antennae	7	flexible polymer	Integrated Circuit	700				No	-	Dennise
31	Payload Board	2	PCB layers, copper, etc	Integrated Circuit	68.15	90.17	95.89	1.27	No	-	Dennise

Appendix C. ELaN-21 Component List by CubeSat: Phoenix

Item Number	Name	Qty	Material	Body Type	Mass (g) (total)	Diameter/Width (mm)	Length (mm)	Height (mm)	High Temp	Melting Temp (F°)	Survivability
1	Phoenix 3U CubeSat	1	Aluminum 7075	Box	3.2	100	325	100	-	-	-
2	+Z panel	1	Aluminum 7075	Flat Plate	49.76	100	337	100	No	-	Dennise
3	-Z panel	1	Aluminum 7075	Flat Plate	56.71	97	96	97	No	-	Dennise
4	+X panel	1	Aluminum 7075	Flat Plate	38.75	83	64	325	No	-	Dennise
5	-X panel	1	Aluminum 7075	Flat Plate	38.75	83	34	325	No	-	Dennise
6	+Y panel	1	Aluminum 7075	Flat Plate	38.75	83	37.5	325	No	-	Dennise
7	-Y panel	1	Aluminum 7075	Flat Plate	38.75	83	19.34	325	No	-	Dennise
8	Corner Rails	4	Anodized Aluminum 7075	Flat Plate	89.65	18.5	0.1528	340	No	-	Dennise
9	3U Solar Panels	2	PCB FR-4/Fiberglass	Flat Plate	56	83	25	322.5	No	-	Dennise
10	S-Band Patch Antenna	1	Aluminum	Sphere	50	89	27.94	81.5	No	-	Dennise
11	GPS Patch Antenna	1	PCB FR-4/Fiberglass	Flat Plate	50	70	1.59	70	No	-	Dennise
12	UHF Turnstyle Antenna Frame	1	Aluminum (Hard Anodized)	Box	74	98	12.7	98	No	-	Dennise
13	UHF Turnstyle Antenna Rods	4	SMA	Cylinder	0.25	1.6	326	136.9	No	-	Dennise
14	Sun Sensors	6	PCB FR-4/Fiberglass	Box	3.5	27.94	96	17.15	No	-	Dennise
15	Deployment Switches	3	Thermoplastic	Box	0.016	3.37	96	23.4	No	-	Dennise
16	Battery	1	PCB FR-4/Fiberglass	Box	335	95.9	93.39	90.2	No	-	Dennise
17	EPS	1	PCB FR-4/Fiberglass	Flat Plate	148	95.9	87.44	90.2	No	-	Dennise
18	MAI ADCS	1	Unfinished Aluminum	Box	694	97	16.26	97	No	-	Dennise
19	FLIR Tau 2 640 IR Camera	1	Anodized Aluminum	Cylinder	475	82		144.51	No	-	Dennise
20	S-Band Transmitter	1	PCB FR-4/Fiberglass	Box	95	96	27.4	90.2	No	-	Dennise
21	UHF Transceiver	1	polimide	Box	24.5	40	19.05	65	No	-	Dennise
22	GPS	1	PCB FR-4/Fiberglass	Box	24	46	96	71	No	-	Dennise
23	OBC	1	polimide	Box	24	40	70	65	No	-	Dennise

24	Motherboard	1	polyimide	Flat Plate	51	92	20	88.9	No	-	Dennise
25	Interface Board	1	PCB FR-4/Fiberglass	Flat Plate	150	92	33.02	88.9	No	-	Dennise
26	FLIR Breakout Board	1	PCB FR-4/Fiberglass	Flat Plate	0.88	25	100	14.48	No	-	Dennise
27	Payload Lens Mount	1	Aluminum 7075	Box	47.54	87	152.4	87	No	-	Dennise
28	Payload Core Mount	1	Aluminum 7075	Box	58.96	87	92	87	No	-	Dennise
29	Electronics Stack Mount (top)	1	Aluminum 7075	Box	44.1	97	144	97	No	-	Dennise
30	Electronics Stack Mount (top)	1	Aluminum 7075	Box	47.1	97	30	97	No	-	Dennise
31	G10 Washers	27	G-10	Cylinder	0.06	5	22	0	No	-	Dennise
32	Screws	112	Stainless Steel	Cylinder	0.062	2.5	6.93	8	Yes	2550°	Dennise
33	Nuts	112	Stainless Steel	Cylinder	0.035	2.5	96	2	Yes	2550°	Dennise
34	Cabling	35	Copper Alloy	Cylinder	0.28	26 AWG	96	various	No	-	Dennise
35	Thermal Heat Straps	8	Copper Alloy	Flat Plate	0.25	10	96	50	No	-	Dennise
36	Electronics Stack Rod	4	Stainless Steel	Cylinder	4.29	3.18	96	117.17	Yes	2550°	Dennise
37	Separation Springs	2	Stainless Steel	Cylinder	0.036	4	96	13	Yes	2550°	Dennise

Appendix D. ELaN_a-21 Component List by CubeSat: SPACEHAUC

Item Number	Name	Qty	Material	Body Type	Mass (g) (total)	Diameter/Width (mm)	Length (mm)	Height (mm)	High Temp	Melting Temp (F°)	Survivability
1	SpaceHAUC 3U CubeSat	1	N/A	Box	2,92	100	340	12	-	-	-
2	Spacecraft Bus Side	2	Aluminum 7075-T6	Box	266.62	82.2	337	2.83	No	-	Demise
3	Solar Panel Frame	4	Aluminum 7075-T6	Panel	308.72	95	96	9.75	No	-	Demise
4	Camera Plate	1	Aluminum 7075-T6	Plate	71.69	10	64	10	No	-	Demise
5	Hinge Base	4	Aluminum 7075-T6	Box	25.08	20	34	5	No	-	Demise
6	Hinge Rotor	4	Aluminum 7075-T6	Plate	18.12	2.02	37.5	N/A	No	-	Demise
7	Hinge Pin	4	Aluminum 7075-T6	Pin	1.68	0.305	19.34	N/A	No	-	Demise
8	1800 Torsion Spring	4	AISI 304 Stainless Steel	Spring	0.1528	0.0382	0.1528	0.305	No	2550°	Demise
9	4-40 Screws		AISI 304 Stainless Steel	Bolt	0	6.35	25	8.5	No	2550°	Demise
10	Dowel Holster	4	Aluminum 7075-T6	Box	9.72	3.175	27.94	N/A	No	-	Demise
11	Dowel	4	Aluminum 7075-T6	Pin	2.192	4.76	1.59	N/A	No	-	Demise
12	Dowel Hex Nut	8	AISI 304 Stainless Steel	Nut	1.4712	1.44	12.7	4.57	No	-	Demise
13	Compression Spring	4	AISI 304 Stainless Steel	Spring	0.4684	82.6	326	2.3	No	-	Demise
14	Solar Panels	4	Commercial FR4	Panel	624	95	96	5	No	-	Demise
15	EPS Front Mount	1	Aluminum 7075-T6	Plate	81.53	95	96	5	No	-	Demise
16	EPS Back Mount	1	Aluminum 7075-T6	Plate	78.24	92.92	93.39	36.75	No	-	Demise
17	Electronic Power Supply (EPS)	1	Commercial FR4	Box	100	93.34	87.44	28.71	No	-	Demise
18	Battery Pack	1	Glass/Polymide	Box	270	6.35	16.26	12.45	No	-	Demise
19	Deployment Switch	2		Box	4				No	-	Demise
20	Wires	1	Copper	Wires	20	14	27.4	5.9	No	-	Demise
21	NanoSSOC-A60 Fine Sun Sensor	1		Box	4	16.51	19.05	1.63	No	-	Demise
22	TSL2561 Coarse Sun Sensor	8		Chip	24	95	96	10	No	-	Demise

23	Magnetorquer Board	1	Aluminum 7075-T6	Plate	98.22	8.5	70	N/A	No	-	Demise
24	Magnetorquer Rods	3	Copper	Cylinder	90	6	20	6.5	No	-	Demise
25	Magnetorquer Rod Collar	4	Aluminum 7075-T6	Box	5.2	22.86	33.02	2.36	No	-	Demise
26	9 DOF Adafuit Magnetometer	1	Commercial FR4	Chip	2.8	62	100	11.73	No	-	Demise
27	ADRV9361	1		Board	60	76.2	152.4	6.65	No	-	Demise
28	ADRV9361 Breakout Board	1		Board	80	54	92	1.57	No	-	Demise
29	Auxiliary Mounting Board	1	Aluminum 7075-T6	Plate	26.94	88	144	1.57	No	-	Demise
30	Base Board	1	Aluminum 7075-T6	Plate	64.09	30	30	41.2	No	-	Demise
31	Camera	1		Cylinder	21	2.5	22	N/A	No	-	Demise
32	Standoff_Camera	4	Aluminum 7075-T6	Cylinder	0.448	6	6.93	20	No	-	Demise
33	Standoff_ADRV	8		Cylinder	8.4	95	96	8	No	-	Demise
34	Tape Antenna Base	1	Aluminum 7075-T6	Plate	114.54	95	96	10	No	-	Demise
35	Antenna Mounting Brace	1	Aluminum 7075-T6	Plate	123.67	95	96	1.57	No	-	Demise
36	Back End Board	1	RO4000	Board	35	95	96	1.57	No	-	Demise
37	Daughter Board	1	RO4000	Board	35	95	96	1.57	No	-	Demise
38	Patch Antenna	1	RO4000	Board	14	16	23.6	4.74	No	-	Demise
39	Tape Cage_Monopole Antenna	2	Aluminum 7075-T6	Plate	1.5	22	9	N/A	No	-	Demise
40	Pulley_Monopole Antenna	2	Aluminum 7075-T6	Cylinder	10.76	4.5	5	4.5	No	-	Demise
41	Spacer_RF Boards	8	AISI 304 Stainless Steel	Cylinder	4.312				Yes	2550°	Demise
42	Wires	1	Copper	Wires	20	100	340	0.2	No	-	Demise
43	Multi-Layer Insulation	1	Insulation	Panel	40				No	-	Demise
44	Radiators	2	Aluminum 7075-T6	Panel	150	N/A	N/A	N/A	No	-	Demise
45	Paints	1	AZ-93 White Paint	Paint	5	100	340	12	No	-	Demise

Appendix E. ELNa-21 Component List by CubeSat: TJREVERB

Item Number	Name	Qty	Material	Body Type	Mass (g) (total)	Diameter / Width (mm)	Length (mm)	Height (mm)	High Temp	Melting Temp (F°)	Survivability
1	2U CubeSat Structural Chassis	1	Aluminum 5052-H32	Box	206	100	100	227	-	-	-
2	SIDE Solar Panel	4	GaAs, G10 Fiberglass	Panel	100	100	226*	2.5	No	-	Dennise
3	pos Z Mounting Plate	1	Aluminum 5052	Sheer Panel	14.935	100	100	1	No	-	Dennise
4	-Z Mounting Plate	1	Aluminum 5052	Sheer Panel	14.935	100	100	1	No	-	Dennise
5	EPS Block, Ragnarok Flight Computer, Aluminum Heat Sink	1	Circuit Boards (FR-4 Fiberglass), Aluminum Heat Sink	Plate-like block	250	96	90	45	No	-	Dennise
6	18650 Li-Ion Battery Dual Cell	2	Lithium polymer	cylinder	256	96	91	21	No	-	Dennise
7	ISIS 3-axis Magnetorquer Board	1	PCB FR-4 Fiberglass, Aluminum, Copper	Board	196	90.1	95.9	17	No	-	Dennise
8	Iridium Radio (Iridium 9603-1 daughterboard on motherboard from NAL Research)	1	FR-4 Fiberglass, Aluminum Heat Sink	box	150	47	80	10	No	-	Dennise
9	GomSpace S-band Radio (TR600)	1	FR-4 Fiberglass, Aluminum	box	200	92.682	88.875	19.531	No	-	Dennise
10	APRS Radio (SAAT4)	1	FR-4 Fiberglass, Aluminum, Stainless Steel	box	150	95.885	86.17	9.087	No	-	Dennise
11	S-Band Patch Antenna	1	Aluminum 8062	box	50	76	-	4	No	-	Dennise
12	Patch Antenna(GPS)	1	Aluminum, Ceramic	Box	50	25	25	8	No	-	Dennise
13	Patch Antenna Near Earth Network	1	Aluminum, Ceramic	Box	10	17	17	9	No	-	Dennise
14	S-Band Heat Sink Block	2	Aluminum	Box	60	97*	97*	10	No	-	Dennise
15	ISIS Antenna Deployer System (Turnstile)	1	Aluminum 6061*	Square plate	100	98 (stowed)	98 (stowed)	7 (stowed)	No	-	Dennise
16	Interface Board GPS/Iridium	1	FR-4 Fiberglass, Aluminum	Square	50	96	92	11.7	No	-	Dennise
17	Circuit board standoffs	20	Aluminum 5052*	cylinder	1	3	-	various	No	-	Dennise

18	Molex Picoblade 4 Pin Connector Female 51021 Series	8	Stainless Steel	connector	0.3376		-	variable	No	-	Demise
19	Molex Picoblade 12 Pin Connector Female 51021 Series	4	Stainless Steel	connector	0.4256		-	variable	No	-	Demise
20	2 Pin Shunt (used as an RBF pin)*	2	Stainless Steel	pin	10	5.08	6.5	2.54	No	-	Demise
21	M3, 8mm Screw A(standoff screws)	20	Stainless Steel	Screws	1	3*	-	8	Yes	2500°	Demise
22	Molex Picoblade 4 Pin Connector Male 53047-0210	8	Stainless Steel	Pin connector	1	11*	6.5*	2.45*	No	-	Demise
23	M2.5, 6mm screw	64	Stainless Steel	Screws	1	2.5*	-	6	Yes	2500°	Demise
24	Kapton Tape	-	Tape	Acrylic Adhesive (Coating)	22.5	-	-	-	No	-	Demise

Appendix F. Elana-23 Component List by CubeSat: UNITE

Item Number	Name	Qty	Material	Body Type	Mass (g) (total)	Diameter / Width (mm)	Length (mm)	Height (mm)	High Temp	Melting Temp (F°)	Survivability
1	UNITE CubeSat	1	Anodized Aluminum 6061	Box		108.15	340.15	108.15	No	-	Demise
2	NSL 3U Bus	2	Anodized Aluminum 6061	Planar	835	99.95	316.22	99.95	No	-	Demise
3	End Plates	6	Anodized Aluminum 6061	Planar	275	12.12	99.95	99.95	Yes	-	Demise
4	Side Panels	3	Ceramic, PCB FR-4	Planar	204	1.59	98.95	82.95	No	-	Demise
5	Patch Antenna	1	Ceramic, PCB FR-4	Planar	45	1.75	35.1	35.1	No	-	Demise
6	Duplex Antenna	3	PCB FR-4	Planar	21.3	9.66	48.41	48.41	No	-	Demise
7	8-Cell Solar Panels	1	PCB FR-4	Planar	291.9	82.95	316.25	1.59	Yes	-	Demise
8	6-Cell Solar Panel	30	GaAs	Planar	64.8	82.59	240.18	1.59	No	-	Demise
9	Solar Cells	4	PCB FR-4	Planar	93	39.7	69.11	0.2	No	-	Demise
10	PCB Fins	1	-	Cylindrical	16.4	0.79	80	9.75	No	-	Demise
11	Horizon Sensor	38	Nylon	Cylindrical	1.1	8.03	20.2	N/A	No	-	Demise
12	Spacers	146	Stainless Steel	Cylindrical	2.28	3.18	N/A	3.18	No	-	Demise
13	Fasteners	4	-	Box	29.2	2.18	N/A	N/A	No	2500°	Demise
14	Deployment Switches	2	-	Box	13	6.35	6.5	20	No	-	Demise
15	Diagnostic Port	1	-	Cylindrical	10	7.17	13.29	5.38	No	-	Demise
16	RBF PIN	1	Anodized Aluminum 6061	Box	200	70	40	37.18	No	-	Demise
17	Batteries	4	Lithium Polymer	Box	13.8	31.75	31.75	9.59	No	-	Demise
18	Magnetometer Board	1	PCB FR-4	Planar	35	1.59	57.14	45.2	No	-	Demise
19	Langmuir Probe Board	1	PCB FR-4	Planar	202	87	90	47.11	No	-	Demise
20	NSL EPSS/Simplex Board	1	PCB FR-4	Box	125	61	118.7	21.59	No	-	Demise
21	NSL Duplex Board	1	PCB FR-4	Planar	27	70	47.5	6.5	No	-	Demise
22	GPS Board	1	PCB FR-4	Planar	39	80	80	7.94	No	-	Demise
23	C&DH Board	1	PCB FR-4	Planar	10	72.5	20.15	6.35	No	-	Demise

24	Magnet Holder	1	Lexan	Planar	47	12.7	67.7	6.35	No	-	Dennise
25	Mu - Metal Rod	2	Hy/Mu-80	Cylindrical	420	80	310	3.175	No	2650°	Dennise
26	Optical Bench	2	Aluminum	Planar	3	2.8	12.31	2.8	No	-	Dennise
27	Magnets	3	Neodymium	Cylindrical	12.2	10.45	1.64	11.9	No	-	Dennise
28	AD590 Temperature Sensor Board	2	PCB FR-4	Planar	19.2	2.18	N/A	N/A	No	-	Dennise
29	Internal Fasteners	96	Stainless Steel	Cylindrical	12	2.18	N/A	6.35	No	2500°	Dennise
30	Spacers	48	Aluminum	Cylindrical	50	N/A	N/A	N/A	No	-	Dennise
31	Cabling	-	Copper, PTFE Insulation	Linear	377	45	75	5	No	-	Dennise
32	Ballast Mass	2	Copper Alloy	Planar	50	N/A	N/A	N/A	No	-	Dennise
33	Silicon	-	-	-	10	N/A	N/A	N/A	No	-	Dennise
34	Epoxy	-	-	-	200	70	40	37.18	No	-	Dennise

Appendix G.

Elana-23 Component List by CubeSat: Virginia CC - Aeterntias

Item Number	Name	Qty	Material	Body Type	Mass (g) (total)	Diameter / Width (mm)	Length (mm)	Height (mm)	High Temp	Melting Temp (F°)	Survivability
1	Aeterntias ODU 1U Chassis	1	-	Box	-	-	-	-	-	-	-
2	CubeSat Structure - Rails // +x-Axis	1	Aluminum 6061	Rectangular Sheet	57,079	100	113.5	6.9	No	-	Dennise
3	CubeSat Structure - Rails // -x-Axis	1	Aluminum 6061	Rectangular Sheet	57,205	100	113.5	6.9	No	-	Dennise
4	CubeSat Structure - Span // +y-Axis	1	Aluminum 6061	Rectangular Box	15,269	19	78.35	4.15	No	-	Dennise
5	CubeSat Structure - Span // -y-Axis	1	Aluminum 6061	Rectangular Box	13,901	15	78.35	4.15	No	-	Dennise
6	CubeSat Structure - Bolts and Fasteners	30	Steel Alloy	Cylindrical Rods	0.6279	2.625	11.375	2.625	No	2500°	Dennise
7	Antenna - Cover Plate	1	Windform	Box	12.443	98	98	1	No	-	Dennise
8	Antenna - Base Plate	1	Aluminum 6061	Box	66.18	96.8	96.8	19.9	No	-	Dennise
9	Antenna - Antenna Swing Arms	2	Windform	L-shaped	1,944	25	50	7.3	No	-	Dennise
10	Antenna - Antenna Blades	4	Steel/copper plate	Sheet	0.5	6	187.4	0.4	Yes	2500°	0 km
11	Antenna - GPS/Iridium Patch Antenna - Toaglas	1	Ceramic	Box	64	25	25	4	No	-	Dennise
12	Drag Brake - Hinge - Top	4	Aluminum 6061	Box/Cylindrical	1	6.921	30	6	No	-	Dennise
13	Drag Brake - Hinge - Bottom	4	Aluminum 6061	Box/Cylindrical	1	30	5	1	No	-	Dennise
14	Drag Brake - Petals - petal 1	1	Lexan	Box	8	65.4	70.8	1.6	No	-	Dennise
15	Drag Brake - Petals - petal 2-4	3	Lexan	Box	9	65.4	70.8	1.6	No	-	Dennise
16	Drag Brake - Springs	4	Alloy Steel	Cylindrical	0.578	4.7244	4.7244	0.5334	Yes	2500°	Dennise
17	Solar Panels with Magnetorquers/CSS - GOMSpace	4	Germanium	Rectangular Sheet	57				No	-	Dennise
18	pinAV GPS-L1 - SkyFox Labs	1	FR4, Metal Alloy	Rectangular Box	47	84	35	12	No	-	Dennise
19	Lithium Radio - Astro Dev	1	FR4, Aluminum	Rectangular Box	48	62	32	11.12	No	-	Dennise

20	EPS/Battery - GOMSpace	1	Lithium Ion, FR4	Rectangular Box	220	96	90	No	-	Demise
21	Radio Board	1	FR4	Square Plate	40	96	90	No	-	Demise
22	GPS Board	1	FR4	Square Plate	45	96	90	No	-	Demise
23	Processor Board	1	FR4	Square Plate	40	96	90	No	-	Demise
24	Mounting Hardware (4 Threaded Rods, 12 Spacers, 12 Nuts)	1	Stainless Steel, Aluminum	Cylindrical Rod, Toroid	20	-	-	Yes	2500°	Demise
25	Z-axis magnetorquer	1	Pre-evacuated enamel copper wire, Space grade epoxy 3M	Rectangular Box	7.5	50	50	No	-	Demise
26	Iridium Radio	1	--	Rectangular Box	11.4	29.6	31.5	No	-	Demise
27	Cables/Connectors	--	Copper alloy, Insulator	---	---	--	--	No	-	Demise
28	IMU - MPU-9250	1	Ceramic, X7R	Square	1	3	3	No	-	Demise
29	Intersat Radio - HopeRF RFM69HCW	1	Ceramic, FR4	Square	1	16	16	No	-	Demise

Appendix H. ELaN_a-23 Component List by CubeSat: Virginia CC - Ceres

Item Number	Name	Qty	Material	Body Type	Mass (g) (total)	Diameter / Width (mm)	Length (mm)	Height (mm)	High Temp	Melting Temp (°F)	Survivability
1	Ceres IU CubeSat	1	-	Box	-	106.7	106.7	113.5	-	-	-
2	CubeSat Structure (Side Walls)	4	Uthman 1010 Substrate with Carbon Nano Tube Matrix	Plate	8	1	83	95	No	-	Dennise
3	CubeSat Structure (Top Plate)	1	Aluminum 5052-H32	Plate	35	100	100	11.58	No	-	Dennise
4	CubeSat Structure (Bottom Plate)	1	Aluminum 5052-H32	Plate	35	100	100	38.3	No	-	Dennise
5	CubeSat Structure (Rails and Feet)	4	Aluminum 5052-H32	Plate	5	8.5	8.5	113.5	No	-	Dennise
6	Mother Board; TI MSP430FR5994	1	FR4	Plate	88	96	90	1.6	No	-	Dennise
7	Clyde Space 3rd Gen. FPS	1	FR4	Plate	86	95.89	90.17	23.24	No	-	Dennise
8	Processing Module; TI MSP430F5438A	1	FR4	Plate	11	54.6	53.4	1.6	No	-	Dennise
9	Batteries; ClydeSpace 20WHr	1	Lithium Ion Polymer, FR4	Plate	246	95.89	90.17	21.4	No	-	Dennise
10	ClydeSpace Solar Panels	3	FR4	Plate	46	83	97	1.6	No	-	Dennise
11	EnduroSat Solar Panel	1	FR4-Tg170	Plate	48	98	98	3.1	No	-	Dennise
12	piNAV GPS	1	FR4, Metal Alloy	Box	47	84	35	12	No	-	Dennise
13	Skyfox Labs PiPatch GPS Antenna	1	FR4, GPS L1 Patch	Plate	50	98	98	5.5	No	-	Dennise
14	EnduroSat UHF Antenna Assembly	1	Hard Anodized Aluminum, FR4	Plate	85	98	98	5.6	No	-	Dennise
15	Radio Board	1	FR4	Plate	24	96	90	1.6	No	-	Dennise
16	GPS and IMU Board	1	FR4	Plate	25	96	90	1.6	No	-	Dennise
17	Astro Dev Radio Li-1	1	FR4, Aluminum	Box	30	62	32	11.12	No	-	Dennise
18	Separation Switches	3	Thermoplastic, Beryllium Copper	Box	3	12.3	20	3.38	Yes	2349°	0 km
19	Separation Spring	1	ASTM A228	Cylinder	1	3	-	10	No	-	Dennise

20	Bondable Terminals	2		Plate	<1	2.7	1.65	0.6	No	-		Dennise
21	Strain Gauge	2	encapsulated K-alloy	Plate	<1	3.18	6.35	0.6	No	-		Dennise
22	Mounting Hardware (Solar Panel Retaining Clips)	8	Stainless Steel	Plate	1	20	20	0.5	Yes	2500°		0 km
23	IMU; Invensense MPU9250	1	Ceramic, X7R	Box	1	3	3	1	No	-		Dennise
24	Intersatellite Radio; HopeRF RFM69HCW	1	Ceramic, FR4	Box	1	16	16	1.8	No	-		Dennise
25	Mounting Hardware (4 Threaded Rods, 12 Spacers, 12 Nuts)	1	Stainless Steel, Aluminium	Cylindrical Rod, Toroid	20	-	-	-	Yes	2500°		0 km
26	Separating Switch Mounts	4	Aluminium	Plate	4	12.3	20	20	No	-		Dennise
27	Mounting Hardware (Nuts and Bolts Pairs)	30	Stainless Steel	Toroid, Cylindrical	2	3	-	7	Yes	2750°		Dennise
28	Cabling (Electrical)	1	Copper alloy, Insulator	Flexible Cable	15	2	300	-	No	-		Dennise
29	Cabling (Co-ax)	1	Copper alloy, Insulator	Flexible Cable	15	3	400	-	No	-		Dennise

Appendix I: ELANa-23 Component List by CubeSat: Virginia CC - Libertas

Item Number	Name	Qty	Material	Body Type	Mass (g) (total)	Diameter / Width (mm)	Length (mm)	Height (mm)	High Temp	Melting Temp (F°)	Survivability
1	Libertas UVA IU CubeSat	1	-	Box	-	106.75	105.66	118.6	No	-	Demise
2	Pumpkin CubeSat Kit Structure (Side Walls and Feet)	1	Aluminum 5052-H32	Box	104	100	100	113.5	No	-	Demise
3	Pumpkin CubeSat Kit Structure (Top Plate)	1	Aluminum 5052-H32	Square Plate	45	100	100	11.58	No	-	Demise
4	Pumpkin CubeSat Kit Structure (Bottom Plate)	1	Aluminum 5052-H32	Square Plate	58	100	100	38.3	No	-	Demise
5	Pumpkin CubeSat Kit (CSK)Motherboard	1	FR4	Square Plate	88	96	90	1.6	No	-	Demise
6	Clyde Space EPS	1	FR4	Square Plate	86	95.89	90.17	23.24	No	-	Demise
7	Pumpkin CSK Pluggable Processing Module	1	FR4	Rectangular Plate	11	54.6	53.4	1.6	No	-	Demise
8	Clyde Space 20 WH Battery Pack (integrated with EPS)	1	Lithium Ion Polymer, FR4	Square Plate	246	95.89	90.17	21.4	No	-	Demise
9	Clyde Space Solar Panels	3	FR4	Rectangular Plate	46	83	97	1.6	No	-	Demise
10	Clyde Space Solar Panel (RBF Cutout)	1	FR4	Rectangular Plate	46	81.74	111	3.58	No	-	Demise
11	EnduroSat Solar Panel	1	FR4-Tg170	Rectangular Plate	48	98	98	3.1	No	-	Demise
12	Skyfox Labs piNAV GPS	1	FR4, Metal Alloy	Rectangular Box	47	84	35	12	No	-	Demise
13	Skyfox Labs PiPatch GPS Antenna	1	FR4, GPS L1 Patch	Square Plate	50	98	98	5.5	No	-	Demise
14	EnduroSat UHF Antenna Assembly	1	Hard Anodized Aluminum, FR4	Square Plate	85	98	98	5.6	No	-	Demise
15	Radio Board	1	FR4	Square Plate	24	96	90	1.6	No	-	Demise
16	GPS and IMU Board	1	FR4	Square Plate	25	96	90	1.6	No	-	Demise
17	Astro Dev Lithium Radio	1	FR4, Aluminum	Rectangular Box	30	62	32	11.12	No	-	Demise
18	Magnets for PMAC	20	Al Ni Co	Cylindrical	1	3.175		4.953	Yes	2651°	Demise
19	Separation Switches	3	Thermoplastic, Beryllium Copper	Rectangular Box	3	12.3	20	3.38	Yes	2349°	0 km

20	Separation/deployment Swinns (in CSK cover plate)	1	ASTM A228	Spring Coil	1	3	-	10	No	-	Demise
21	Mounting Hardware (Solar Panel Retaining Clips)	8	Stainless Steel	Bent Plate	1	20	20	0.5	Yes	2500°	Demise
22	Invensense MPU9250 IMU	1	Ceramic XTR	Box	1	3	3	1	No	-	Demise
23	HopeRF RFM69HCW Intersatellite radio	1	Ceramic/FR4	Box	1	16	16	1.8	No	-	Demise
24	Separation Switch Mounts	4	Aluminum	Bent Plate	4	12.3	20	20	No	-	Demise
25	Magnet Mounting Hardware	4	Aluminum	Cylindrical	4	4.175	-	25	No	-	Demise
26	Mounting Hardware (Nuts and Bolts Pairs)	45	Stainless Steel	Toroid, Cylindrical	2	3	-	7	Yes	-	Demise
27	Mounting Hardware (4 Threaded Rods, 12 Spacers, 12 Nuts)	1	Stainless Steel, Aluminum	Cylindrical Rod, Toroid	20	-	-	-	Yes	2500°	Demise
28	Cabling (Electrical)	1	Copper alloy, Insulator	Flexible Cable	15	2	600	-	No	-	Demise
29	Cabling (RG178 Coax)	1	Copper alloy, Insulator	Flexible Cable	15	3	400	-	No	-	Demise

Appendix J: ELaN-21 TechEdSat-8 ODAR

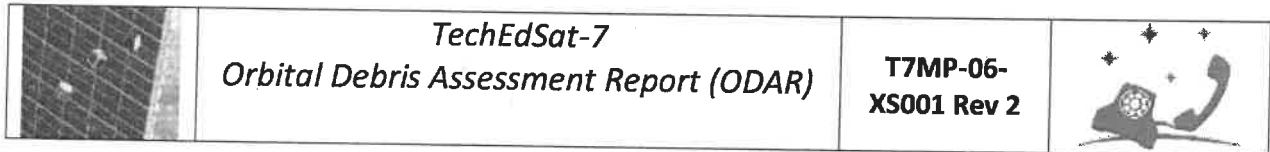

TechEdSat-7
Orbital Debris Assessment Report (ODAR)
&
End of Mission Plan (EOMP)

In accordance with NPR 8715.6A, this report is presented as compliance with the required reporting format per NASA-STD-8719.14, APPENDIX A.

Report Version: 2 (11/09/2017)

DAS Software Used in This Analysis: DAS v2.1.1

VERSION APPROVAL and/or FINAL APPROVAL*:

Michael J. Wright
 ESM Program Manager
 NASA Ames Research Center

Marcus S. Murbach
 TechEdSat 7 Project Manager
 NASA Ames Research Center

Richard Morrison
 Safety and Mission Assurance Office
 NASA Ames Research Center

Michel Liu
 Director of Safety and Mission Assurance
 NASA Ames Research Center

Prepared By:

Meredith Campbell
 TechEdSat ME
 NASA Ames Research Center

Ali Guarneros Luna
 TechEdSat S&MA
 NASA Ames Research Center

Record of Revisions				
REV	DATE	AFFECTED PAGES	DESCRIPTION OF CHANGE	AUTHOR (S)
0	10/24/2017	All	Initial Draft	Meredith Campbell
1	10/27/2017	All	New mass an launch date	Meredith Campbell
2	11/9/2017	All	Update information on Revision of ODAR Report 8719.14B	Ali Guarneros Luna

Table of Contents

Self-assessment and OSMA assessment of the ODAR using the format in Appendix A.2 of NASA-STD-8719.14:

Assessment Report Format

Mission Description

ODAR Section 1: Program Management and Mission Overview

ODAR Section 2: Spacecraft Description

ODAR Section 3: Assessment of Spacecraft Debris Released during Normal Operations

ODAR Section 4: Assessment of Spacecraft Intentional Breakups and Potential for Explosions.

ODAR Section 5: Assessment of Spacecraft Potential for On-Orbit Collisions

ODAR Section 6: Assessment of Spacecraft Postmission Disposal Plans and Procedures

ODAR Section 7: Assessment of Spacecraft Reentry Hazards

ODAR Section 8: Assessment for Tether Missions

Appendix A: Acronyms

Appendix B: Battery Data Sheet

Appendix C: Wiring Schematics



Self-assessment and OSMA assessment of the ODAR using the format in Appendix A.2 of NASA-STD-8719.14:

A self-assessment is provided below in accordance with the assessment format provided in Appendix A.2 of NASA-STD-8719.14. In the final ODAR document, this assessment will reflect any inputs received from OSMA as well.

Orbital Debris Self-Assessment Report Evaluation: TechEdSat-7 Mission

Reqm't #	Launch Vehicle					Spacecraft				Comments
	Compliant	N/A	Not Compliant	Incomplete	Standard Non-Compliant	Compliant	N/A	Not Compliant	Incomplete	
4.3-1.a 25 years						X				For all incompletes, include risk assessment (low, Medium, or high risk) of non-compliance & Project Risk Tracking # No Debris Released in LEO. See note 1.
4.3-1.b <100 object year limit						X				No Debris Released in LEO. See note 1.
4.3-2 GEO +/- 200Km						X				No Debris Released in GEO. See note 1.
4.4-1 < 0.001 Explosive Risk				X		X				There is no explosive hazard.
4.4-2 Passive Energy Source				X		X				There is no explosive hazard.
4.4-3 Limit Long-Term Risk				X		X				No planned breakups.
4.4-4 Limit BU Short term Risk				X		X				No planned breakups. 1.
4.5-1 <0.001 10cm Impact Risk				X		X				See note 1.
4.5-2 Postmission Disposal Risk						X				
4.6-1(a) Atmosphere Energy Option				X		X				See note 1.
4.6-1(b) Storage Orbit				X		X				See note 1.
4.6-1(c) Direct Retrieval				X		X				See note 1.
4.6-2 GEO Disposal				X		X				See note 1.
4.6-3 MEO Disposal				X		X				See note 1.
4.6-4 Disposal Reliability				X		X				See note 1.
4.6-5 Summary of DeOrbit				X		X				See note 1.
4.7-1 Ground Population Risk				X		X				See note 1.
4.8-1 Tethers Risk						X				No tethers used.

Notes:

1. All of the other portions of the launch stack are non-NASA and TechEdSat-7 is not the lead.

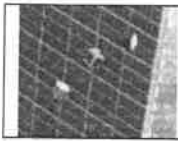

Pre-Launch EOMP Evaluation: TechEdSat Mission

Reqm't #	Spacecraft				EOMP Comments
	Compliant	N/A	Not Compliant	N/A	
4.3-1.a 25 years	<input checked="" type="checkbox"/>	<input type="checkbox"/>	<input type="checkbox"/>	<input type="checkbox"/>	
4.3-1.b <100 object year limit	<input checked="" type="checkbox"/>	<input type="checkbox"/>	<input type="checkbox"/>	<input type="checkbox"/>	
4.3-2 GEO +/- 200Km	<input checked="" type="checkbox"/>	<input type="checkbox"/>	<input type="checkbox"/>	<input type="checkbox"/>	
4.4-1 <0.001 Explosion Risk	<input checked="" type="checkbox"/>	<input type="checkbox"/>	<input type="checkbox"/>	<input type="checkbox"/>	
4.4-2 Passive Energy Source	<input checked="" type="checkbox"/>	<input type="checkbox"/>	<input type="checkbox"/>	<input type="checkbox"/>	Passive RF systems. No planned breakups. Very low probability of breakup or debris generation due to explosion.
4.4-3 Limit Long-Term Risk	<input checked="" type="checkbox"/>	<input type="checkbox"/>	<input type="checkbox"/>	<input type="checkbox"/>	No planned breakups.
4.4-4 Limit BU Short term Risk	<input checked="" type="checkbox"/>	<input type="checkbox"/>	<input type="checkbox"/>	<input type="checkbox"/>	
4.5-1 <0.001 10cm Impact Risk	<input checked="" type="checkbox"/>	<input type="checkbox"/>	<input type="checkbox"/>	<input type="checkbox"/>	
4.5-2 Postmission Disposal Risk	<input checked="" type="checkbox"/>	<input type="checkbox"/>	<input type="checkbox"/>	<input type="checkbox"/>	
4.6-1(a) Atmosphere Energy Option	<input checked="" type="checkbox"/>	<input type="checkbox"/>	<input type="checkbox"/>	<input type="checkbox"/>	
4.6-1(b) Storage Orbit	<input checked="" type="checkbox"/>	<input type="checkbox"/>	<input type="checkbox"/>	<input type="checkbox"/>	N/A. No ability to maneuver to higher orbit.
4.6-1(c) Direct Retrieval	<input checked="" type="checkbox"/>	<input type="checkbox"/>	<input type="checkbox"/>	<input type="checkbox"/>	N/A. Atmospheric re-entry.
4.6-2 GEO Disposal	<input checked="" type="checkbox"/>	<input type="checkbox"/>	<input type="checkbox"/>	<input type="checkbox"/>	N/A. Not in GEO
4.6-3 MEO Disposal	<input checked="" type="checkbox"/>	<input type="checkbox"/>	<input type="checkbox"/>	<input type="checkbox"/>	N/A. Orbit not between LEO and GEO.
4.6-4 Disposal Reliability	<input checked="" type="checkbox"/>	<input type="checkbox"/>	<input type="checkbox"/>	<input type="checkbox"/>	No operation is required to execute atmospheric re-entry
4.6-5 Summary of DeOrbit	<input checked="" type="checkbox"/>	<input type="checkbox"/>	<input type="checkbox"/>	<input type="checkbox"/>	
4.7-1 Ground Population Risk	<input checked="" type="checkbox"/>	<input type="checkbox"/>	<input type="checkbox"/>	<input type="checkbox"/>	
4.8-1 Tethers Risk	<input checked="" type="checkbox"/>	<input type="checkbox"/>	<input type="checkbox"/>	<input type="checkbox"/>	

Assessment Report Format:

ODAR Technical Sections Format Requirements:

This ODAR follows the format in NASA-STD-8719.14, Appendix A.1 and includes the content indicated at a minimum in each section 2 through 8 below for the TechEdSat-7 satellite. Sections 9 through 14 apply to the launch vehicle ODAR and are not covered here.

ODAR Section 1: Program Management and Mission Overview

Mission Directorate: ARC Code R Office

Engineer Director: David Korsmeyer, ARC

Mission Design Division, Division Chief: Charles Richey, ARC

Project Manager/Senior Scientist: Marcus Murbach

Schedule of mission design and development milestones from NASA mission selection through proposed launch date, including spacecraft PDR and CDR (or equivalent) dates*:

Mission Selection:	August 2017
Mission Preliminary Design Review:	August 2017
Mission Critical Design Review:	January 2018
Launch:	April 2018
Begin Operation:	April 2018

Mission Overview:

The Technical Education Satellite 7 (TechEdSat-7) satellite will be integrated onto Virgin Orbit's LauncherOne. TechEdSat-7 will test and validate two different technologies in Low Earth Orbit (LEO): demonstration of the Exo-Brake and demonstration of the viability of the Iridium 9602 communication module.

The satellite will be inserted into orbit at an apogee of approximately 500 km, perigee of 500 km, with an inclination of 90 degrees. Transmission of data will begin 1 minute after deployment from the launch vehicle. The Exo-Brake will deorbit the satellite approximately 26 weeks after deployment concluding the mission.

TechEdSat-7 will fly on the Virgin Orbit CRS-13 mission, and will utilize the Xtenti FANTM RAiL separation system. There are no propellants.

Launch vehicle and launch site: Virgin Orbit LauncherOne, Mojave Air & Space Port (MHV) with air launch over the Pacific Ocean

Proposed launch date: April, 2018

Mission duration: 26 weeks

Launch and deployment profile, including all parking, transfer, and operational orbits with apogee, perigee, and inclination:

TechEdSat-7 will be launched on a Virgin Orbit LauncherOne launch vehicle using the Xtenti FANTM RAIL separation system.

The TechEdSat-7 orbit is defined as follows:

Apogee: 500 km

Perigee: 500 km

Inclination: 90 degrees.

TechEdSat-7 has no propulsion and therefore does not actively change orbits. TechEdSat-7 will deploy the Exo-Brake, slow down, lose altitude, and then disintegrate upon atmospheric re-entry approximately 26 weeks after deployment. If the Exo-Brake fails to deploy the satellite will re-enter in 256 weeks.

Interaction or potential physical interference with other operational Spacecraft:

The main risks of this satellite are the Canon BP-930 battery used by the spacecraft (flown in and certified by the ISS program) and the possibility of the TechEdSat-7 impacting another deployment. Since the TechEdSat-7 is a 3.5U CubeSat being launched from the system, and NanoRacks has shown that the likelihood of any CubeSat impacting the ISS is very minimal (validated by the ISS Program Office).

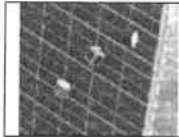

ODAR Section 2: Spacecraft Description

Physical description of the spacecraft:

TechEdSat-7 is a 2U nanosatellite with dimensions of 10 cm x 10 cm x 21.7 cm and a total mass approximately equal to 2.5 kg. TechEdSat-7's payload carries a deployable Exo-Brake as a technology demonstration. The deployed Exo-Brake has a cross-sectional area of 1.25 m².

TechEdSat-7 will contain the following systems: one power board, one CUBIT RFID tag, one Crayfish board, one Iridium 9602 modem, one OEM 615 GPS, two Canon BP-930 batteries, two patch antennas, and one helical antenna.

- The Iridium 9602 modem will have one patch antenna.
- The OEM615 GPS shares a dual patch antenna with the Iridium 9602 modem.
- The power board will control the deployment of the Exo-Brake.

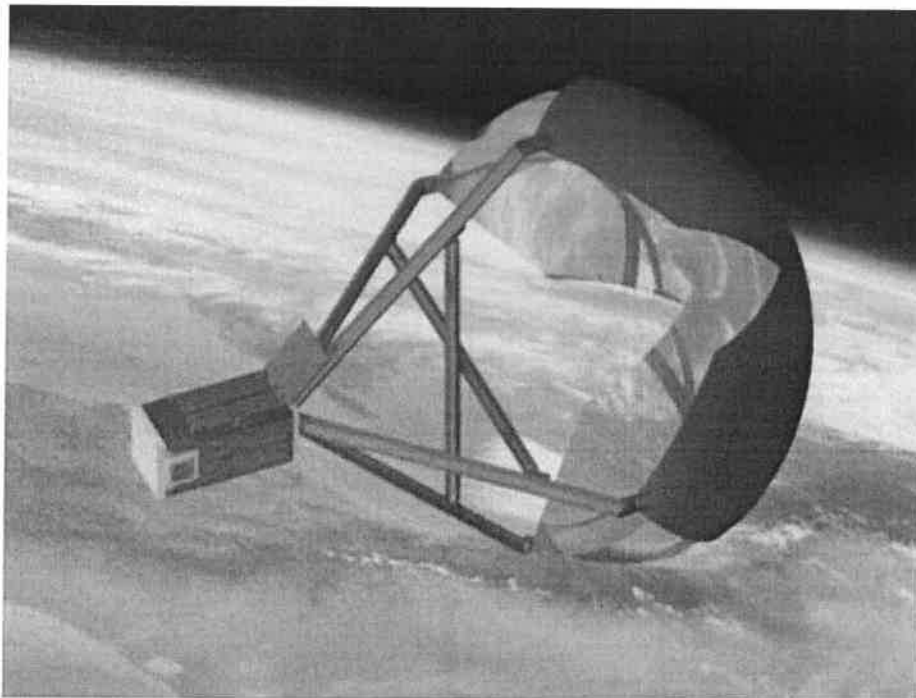
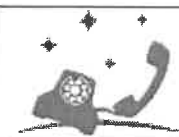
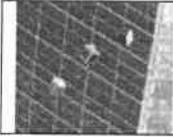

Figure 1: TechEdSat-7 Fully Deployed View



Total satellite mass at launch, including all propellants and fluids: 2.5 kg

Dry mass of satellite at launch, excluding solid rocket motor propellants: 2.5 kg

Description of all propulsion systems (cold gas, mono-propellant, bi-propellant, electric, nuclear):

There will be no propulsion systems on TechEdSat-7.

Identification, including mass and pressure, of all fluids (liquids and gases) planned to be on board and a description of the fluid loading plan or strategies, excluding fluids in sealed heat pipes.

Not applicable, there will be no fluids or gasses on board.

Fluids in Pressurized Batteries:

None. TechEdSat-7 uses unpressurized standard COTS Lithium Ion battery cells.

Description of attitude control system and indication of the normal attitude of the spacecraft with respect to the velocity vector:

TechEdSat-7 does not have any attitude control system, but it does include an IMU to determine the orientation of the satellite (any attitude control comes from the aerodynamics of the Exo-Brake).

Description of any range safety or other pyrotechnic devices:

None. The TechEdSat-7 satellite will be launched powered off and a Remove-Before-Flight (RBF) pin is used to prevent accidental activation.

Description of the electrical generation and storage system:

The power will be generated by solar panels and stored in two Lithium Ion batteries. The batteries that will be used are Canon BP-930 (supplied by the ISS Program Office). See attached data sheet (Appendix B). This battery is approved by the ISS for flight. The dimensions of the battery are 4 x 7 x 3.8 cm and the weight is 0.18 kg.

Identification of any other sources of stored energy not noted above:

None.

Identification of any radioactive materials on board:

None.

ODAR Section 3: Assessment of Spacecraft Debris Released during Normal Operations

Identification of any object (>1 mm) expected to be released from the spacecraft any time after launch, including object dimensions, mass, and material:

None. There are no intentional releases.

Rationale/necessity for release of each object:

N/A.

Time of release of each object, relative to launch time:

N/A.

Release velocity of each object with respect to spacecraft:

N/A.

Expected orbital parameters (apogee, perigee, and inclination) of each object after release:

N/A.

Calculated orbital lifetime of each object, including time spent in Low Earth Orbit (LEO):

N/A.

Assessment of spacecraft compliance with Requirements 4.3-1 and 4.3-2 (per DAS v2.1)

4.3-1, Mission Related Debris Passing Through LEO:

COMPLIANT. No debris released >1mm, while passing through LEO.

4.3-2, Mission Related Debris Passing Near GEO:

COMPLIANT. No debris released will transverse GEO.

ODAR Section 4: Assessment of Spacecraft Intentional Breakups and Potential for Explosions.

Potential causes of spacecraft breakup during deployment and mission operations:

There is no credible scenario that would result in spacecraft breakup during normal deployment and operations.

Summary of failure modes and effects analyses of all credible failure modes, which may lead to an accidental explosion:

In-mission failure of a battery cell protection circuit could lead to a short circuit resulting in overheating and a very remote possibility of battery cell explosion. The battery safety systems discussed in the FMEA (see requirement 4.4-1 below) describe the combined faults that must occur for any of nine (9) independent, mutually exclusive failure modes that could lead to a battery explosion.

Detailed plan for any designed spacecraft breakup, including explosions and intentional collisions:

There are no planned breakups other than during atmospheric entry for disposal.

List of components which shall be passivated at End of Mission (EOM) including method of passivation and amount which cannot be passivated:

None.

Rationale for all items which are required to be passivated, but cannot be due to their design:

TechEdSat-7 will be in orbit for 26 weeks with successful deployment of the Exo-Brake based on the DAS analysis shown in this report. If the Exo-Brake fails to deploy, TechEdSat-7 will be in orbit for 256 weeks based on the DAS analysis shown in this report. Therefore, no post-mission passivation will be performed, as the satellite will burn up on re-entry at the end of the mission.

Assessment of spacecraft compliance with Requirements 4.4-1 through 4.4-4:

Requirement 4.4-1: Limiting the risk to other space systems from accidental explosions during deployment and mission operations while in orbit about Earth or the Moon, or Mars, or in the vicinity of Sun-Earth or Earth-Moon Lagrange Points:

For each spacecraft and launch vehicle orbital stage employed for a mission, the program or project shall demonstrate, via failure mode and effects analyses or equivalent analyses, that the integrated probability of explosion for all credible failure modes of each spacecraft and launch vehicle does not exceed 0.001 (excluding small particle impacts) (Requirement 56449).

Compliance statement:

Required Probability: 0.001.

Expected Probability: 0.000.

Supporting Rationale and FMEA details:

Payload Pressure Vessel Failure:

TechEdSat-7 is vented per ISS safety standards. It is not a sealed container.

Battery explosion:

Effect: All failure modes below might result in battery explosion with the possibility of orbital debris generation. However, in the unlikely event that a battery cell does explosively rupture, the small size, mass, and potential energy, of these small batteries is such that while the spacecraft could be expected to vent gases, most debris from the battery rupture should be contained within the vessel due to the lack of penetration energy. Note also that this same battery combination has been tested extensively, and now flown several times with no noted anomaly.

Probability: Very Low. It is believed to be less than 0.1% given that multiple independent (not common mode) faults must occur for each failure mode to cause the ultimate effect (explosion).

Failure mode 1: Battery Internal short circuit.

Mitigation 1: Complete proto-qualification and environmental acceptance tests of the Canon BP-930 battery by JSC ISS program. The acceptance tests are shock, vibration, thermal cycling, and vacuum tests followed by maximum system rate-limited charge and discharge to prove that no internal short circuit sensitivity exists.

Combined faults required for realized failure: Environmental testing **AND** functional charge/discharge tests must both be ineffective in discovery of the failure mode.

Failure Mode 2: Internal thermal rise due to high load discharge rate.

Mitigation 2: Each cell includes a positive temperature coefficient (PTC) variable resistance device that ensures high rate discharge is limited to acceptable levels if thermal rise occurs in the battery.

Combined faults required for realized failure: The PTC must fail **AND** spacecraft thermal design must be incorrect **AND** external over current detection and protection must fail for this failure mode to occur.

Failure Mode 3: Overcharging and excessive charge rate.

Mitigation 3: The satellite bus battery charging circuit design eliminates the possibility of the batteries being overcharged if circuits function nominally. This circuit has been proto-qualification tested for survival in shock, vibration, and thermal-vacuum environments. The charge circuit disconnects the incoming current when battery voltage indicates normal full charge at 8.4 V. If this circuit fails to operate, continuing charge can cause gas generation. The batteries include overpressure release vents that allow gas to escape, virtually eliminating any explosion hazard.

Combined faults required for realized failure:

- 1) **For overcharging:** The charge control circuit must fail to function **AND** the PTC device must fail (or temperatures generated must be insufficient to cause the PTC device to modulate) **AND** the overpressure relief device must be inadequate to vent generated gasses at acceptable rates to avoid explosion.
- 2) **For excessive charge rate:** The maximum charging rate from a single solar panel when in AM 1.5 G conditions (on Earth, perpendicular to the sun) is 200 mA. The maximum charge rate our battery can accept is 3 A. The battery is a proto-qualified Canon BP-930 from the JSC ISS program, and has four US18650S cells. The battery itself has two parallel strings of 2 cells connected in series, and thus having 4 cells. Due to solar panel current limits and their direction-facing arrangement on the satellite, there is no physical means of exceeding charging rate limits, even if only a single string from the battery was accepting charge. For this failure mode to become active one string must fail to accept a charge **AND** the charge control circuit on the remaining string fails. The overpressure relief vent keeps the battery cells from rupturing, and is thus limited to worst-case effects of overcharging.

Failure Mode 4: Excessive discharge rate or short circuit due to external device failure or terminal contact with conductors not at battery voltage levels (due to abrasion or inadequate proximity separation).

Mitigation 4: This failure mode is negated by a) proto-qualification tested short circuit protection on each external circuit, b) design of battery packs and insulators such that no contact with nearby board traces is possible without being caused by some other mechanical failure, c) obviation of such other mechanical failures by proto-qualification and acceptance environmental tests (shock, vibration, thermal cycling, and thermal-vacuum tests).

Combined faults required for realized failure: The PTC must fail **AND** an external load must fail/short-circuit **AND** external over-current detection and disconnect function must fail to enable this failure mode.

Failure Mode 5: Inoperable vents.

Mitigation 5: Battery vents are not inhibited by the battery holder design or the spacecraft.

Combined effects required for realized failure: The manufacturer fails to install proper venting and ISS environmental stress screening fails to detect failed vents.

Failure Mode 6: Crushing.

Mitigation 6: This mode is negated by spacecraft design. There are no moving parts in the proximity of the batteries.

Combined faults required for realized failure: A catastrophic failure must occur in an external system AND the failure must cause a collision sufficient to crush the batteries leading to an internal short circuit AND the satellite must be in a naturally sustained orbit at the time the crushing occurs.

Failure Mode 7: Low level current leakage or short-circuit through battery pack case or due to moisture-based degradation of insulators.

Mitigation 7: These modes are negated by a) battery holder/case design made of non-conductive plastic, and b) operation in vacuum such that no moisture can affect insulators.

Combined faults required for realized failure: Abrasion or piercing failure of circuit board coating or wire insulators AND dislocation of battery packs AND failure of battery terminal insulators AND failure to detect such failures in environmental tests must occur to result in this failure mode.

Failure Mode 8: Excess temperatures due to orbital environment and high discharge combined.

Mitigation 8: The spacecraft thermal design will negate this possibility. Thermal rise has been analyzed in combination with space environment temperatures showing that batteries do not exceed normal allowable operating temperatures, which are well below temperatures of concern for explosions.

Combined faults required for realized failure: Thermal analysis AND thermal design AND mission simulations in thermal-vacuum chamber testing AND the PTC device must fail AND over-current monitoring and control must all fail for this failure mode to occur.

Failure Mode 9: Polarity reversal due to over-discharge caused by continuous load during periods of negative power generation vs. consumption.

Mitigation 9: In nominal operations, the spacecraft EPS design negates this mode because the processor will stop when voltage drops too low, below 7 V. This disables ALL connected loads, creating a guaranteed power-positive charging scenario. The spacecraft will not restart or connect any loads until battery voltage is above the acceptable threshold. At this point, only the safe mode processor is enabled and charging the battery commences. Once the battery reaches 90% of the peak voltage (around 7.5 V), it will switch to nominal mode and will be able to receive ground commands for continuing mission functions.

Combined faults required for realized failure: The microcontroller must stop executing code AND significant loads must be commanded/stuck "on" AND power margin analysis must be wrong AND the charge control circuit must fail for this failure mode to occur.

Failure Mode 10: Excess battery temperatures due to post mission orbital environment and constant solar panel overcharge while satellite is powered off.

Mitigation 10: Selection of the ISS-approved Canon BP-930 battery packs (GSE from the NASA/Johnson Space Center). These battery packs have battery protection circuits, which prevent over-charge and over-heating. They are lot-tested and supplied as GSE (Government Furnished Equipment) from the NASA/Johnson Space Center. In terms of the orbit environment, the previous TechEdSat-1, TechEdSat-3, and TechEdSat-4, TechEdSat-5 (using the same packaging and battery pack) showed no signs of overeating from environmental heating.

Requirement 4.4-2: Design for passivation after completion of mission operations while in orbit about Earth or the Moon:

Design of all spacecraft and launch vehicle orbital stages shall include the ability to deplete all onboard sources of stored energy and disconnect all energy generation sources when they are no longer required for mission operations or post mission disposal or control to a level which cannot cause an explosion or deflagration large enough to release orbital debris or break up the spacecraft. The design of depletion burns and ventings should minimize the probability of accidental collision with tracked objects in space (Requirement 56450).

Compliance statement:

TechEdSat-7 will be in orbit for 24 weeks with successful deployment of the Exo-Brake. If the Exo-Brake fails to deploy, TechEdSat-7 will be in orbit for approximately 253 weeks based on the DAS analysis shown in this report. Therefore, no post-mission passivation will be performed, as the satellite will burn up on re-entry at the end of the mission. Therefore, the TechEdSat-7 battery will meet the above requirement.

Requirement 4.4-3. Limiting the long-term risk to other space systems from planned breakups for Earth, lunar, Mars, Sun-Earth Lagrange Point, and Earth-Moon Lagrange Point missions:

Planned explosions or intentional collisions shall:

- a. For LEO-crossing missions, be conducted at an altitude such that for orbital debris fragments larger than 10 cm the object-time product does not exceed 100 object-years. For example, if the debris fragments greater than 10cm decay in the maximum allowed 1 year, a maximum of 100 such fragments can be generated by the breakup.
- b. Not generate debris larger than 1 mm that remains in Earth, lunar, or Mars orbits or in the vicinity of Sun-Earth or Earth-Moon Lagrange points longer than one year

Compliance statement:

This requirement is not applicable. There are no planned breakups.

Requirement 4.4-4: Limiting the short-term risk to other space systems from planned breakups for Earth, lunar, Mars, Sun-Earth Lagrange Point, and Earth-Moon Lagrange Point missions:

Immediately before a planned explosion or intentional collision, the probability of debris, orbital or ballistic, larger than 1 mm colliding with any operating spacecraft within 24 hours of the breakup shall be verified to not exceed 10⁻⁶.

Compliance statement:

This requirement is not applicable. There are no planned breakups.

ODAR Section 5: Assessment of Spacecraft Potential for On-Orbit Collisions

Assessment of spacecraft compliance with Requirements 4.5-1 and 4.5-2 (per DAS v2.1, and calculation methods provided in NASA-STD-8719.14, section 4.5.4):

Requirement 4.5-1. Limiting debris generated by collisions with large objects when in Earth orbit: For each spacecraft and launch vehicle orbital stage in or passing through LEO, the program or project shall demonstrate that, during the orbital lifetime of each spacecraft and orbital stage, the probability of accidental collision with space objects larger than 10 cm in diameter does not exceed 0.001. For spacecraft and orbital stages near GEO, the time-integrated probability -when they are in the GEO protection zone -of accidental collision with space objects larger than 10 cm in diameter shall not exceed 0.001 (Requirement 56506).

Large Object Impact and Debris Generation Probability: 0.000000; COMPLIANT.

Requirement 4.5-2. Limiting debris generated by collisions with small objects when operating in Earth: For each spacecraft, the program or project shall demonstrate that, during the mission of the spacecraft, the probability of accidental collision with orbital debris and meteoroids sufficient to prevent compliance with the applicable post mission disposal requirements does not exceed 0.01 (Requirement 56507).

Small Object Impact and Debris Generation Probability: 0.000000; COMPLIANT

ODAR Section 6: Assessment of Spacecraft Postmission Disposal Plans and Procedures

6.1 Description of spacecraft disposal option selected: Two cases will be considered for this section. The first case is called "Nominal Deployment" in which the Exo-Brake successfully

deploys and de-orbits the satellite. The second case is called “No Deployment” in which the Exo-Brake fails to deploy and the satellite de-orbits naturally due to atmospheric friction.

Case 1: *Nominal Deployment* The satellite will de-orbit due to the deployed Exo-Brake. There is no propulsion system and burn at re-entry.

Case 2: *Failed Deployment* The satellite will de-orbit naturally by atmospheric re-entry. There is no propulsion system and burn at re-entry.

6.2 Plan for any spacecraft maneuvers required to accomplish post mission disposal: None.

6.3 Calculation of area-to-mass ratio after post mission disposal, if the controlled reentry option is not selected:

Case 1: *Nominal Deployment*

Spacecraft Mass: 2.5 kg

Cross-sectional Area: 1.25 m²

Area to mass ratio: 1.25/2.5 = 0.5 m²/kg

Case 2: *Failed Deployment*

Spacecraft Mass: 2.5 kg

Cross-sectional Area: 0.0217 m²

Area to mass ratio: 0.0217/2.5 = 0.00868 m²/kg

6.4 Assessment of spacecraft compliance with Requirements 4.6-1 through 4.6-4 (per DAS v 2.1 and NASA-STD-8719.14 section):

Requirement 4.6-1. Disposal for space structures passing through LEO: A spacecraft or orbital stage with a perigee altitude below 2000 km shall be disposed of by one of three methods: (Requirement 56557)

a. Atmospheric reentry option:

- Leave the space structure in an orbit in which natural forces will lead to atmospheric reentry within 25 years after the completion of mission but no more than 35 years after launch; or
- Maneuver the space structure into a controlled de-orbit trajectory as soon as practical after completion of mission.

b. Storage orbit option: Maneuver the space structure into an orbit with perigee altitude greater than 2000 km and ensure its apogee will be below GEO altitude - 200 km for 100 years.

c. Direct retrieval: Retrieve the space structure and remove it from orbit within 10 years after completion of mission.

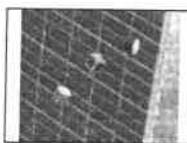

Analysis:

Case 1: Nominal Deployment

TechEdSat-7 satellite reentry is COMPLIANT using Method “a.” TechEdSat-7 will re-enter in 0.504 years (approximately 26 weeks) after launch with orbit history shown in Figure 2.

Case 2: Failed Deployment

TechEdSat-7 satellite reentry is COMPLIANT using Method “a.” TechEdSat-7 will re-enter in 4.928 years (approximately 256 weeks) after launch with orbit history as shown in Figure 3.

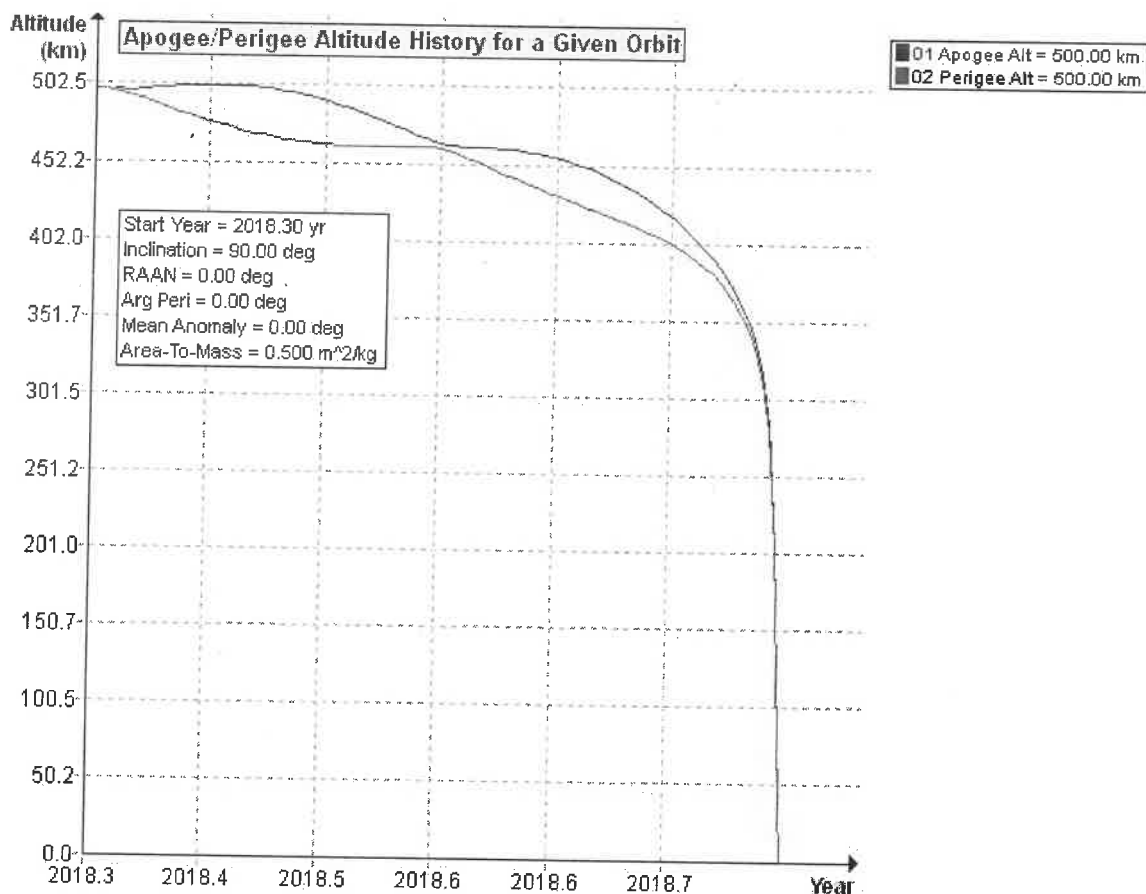

Figure 2: TechEdSat-7 Orbit History for Case 1: Nominal Deployment

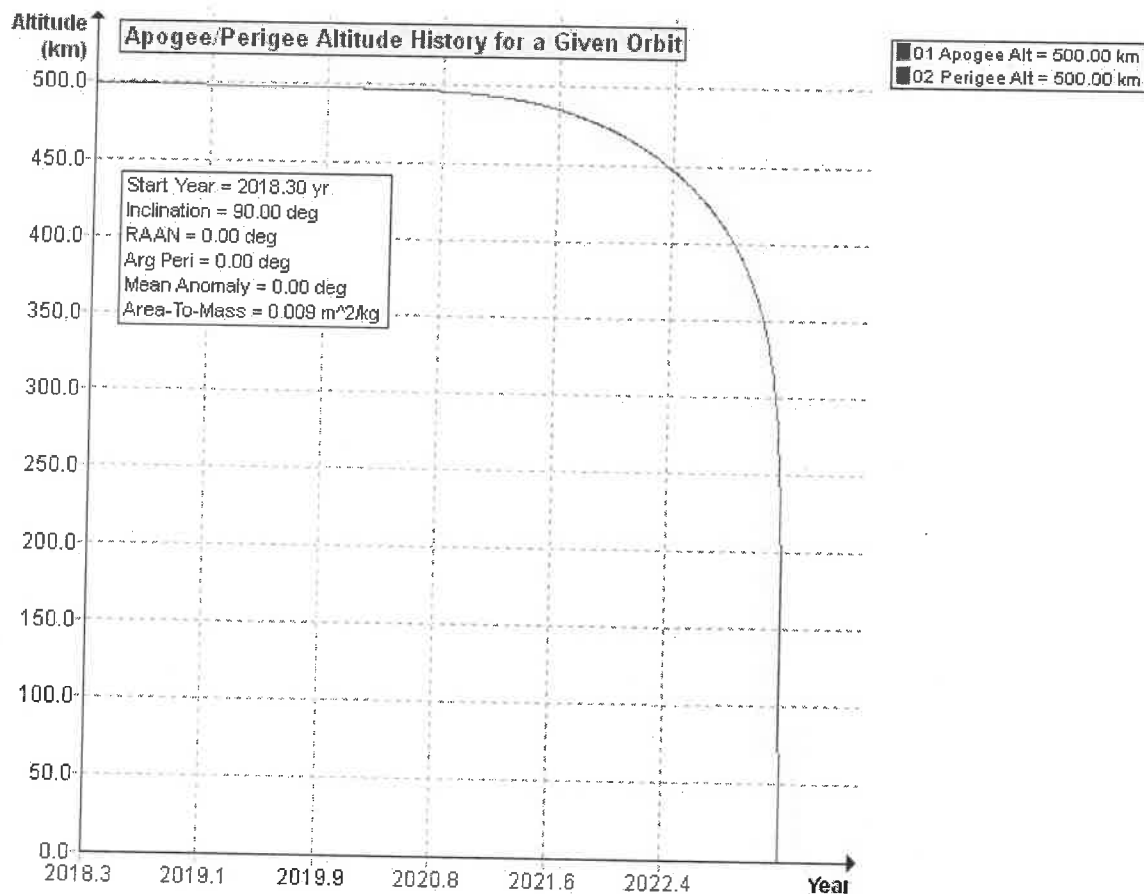

Figure 3: TechEdSat-7 Orbit History for Case 2: Failed Deployment

Requirement 4.6-2. Disposal for space structures near GEO. A spacecraft or orbital stage in an orbit near GEO shall be maneuvered at EOM to a disposal orbit above GEO with a predicted minimum perigee of GEO +200 km (35,986 km) or below GEO with a predicted maximum apogee of GEO -200 km (35,586 km) for a period of at least 100 years after disposal.

Analysis: Not applicable. TechEdSat-7 orbit is in LEO.

Requirement 4.6-3. Disposal for space structures between LEO and GEO.

- a. A spacecraft or orbital stage shall be left in an orbit with a perigee greater than 2000 km above the Earth's surface and apogee below GEO altitude -200 km for 100 years.
- b. A spacecraft or orbital stage shall not use nearly circular disposal orbits near regions of high value operational space structures, such as the Global Navigation Satellite Systems near the semi-synchronous altitudes

Analysis: Not applicable. TechEdSat-7 orbit is in LEO.

Requirement 4.6-4. Reliability of Post mission Disposal Operations in Earth Orbit: NASA space programs and projects shall ensure that all post mission disposal operations to meet Requirements 4.6-1, 4.6-2, and/or 4.6-3 are designed for a probability of success as follows:

- a. Be no less than 0.90 at EOM.
- b. For controlled reentry, the probability of success at the time of reentry burn must be sufficiently high so as not to cause a violation of Requirement 4.7-1 pertaining to limiting the risk of human casualty.

Analysis:

Case 1: Nominal Deployment

TechEdSat-7 de-orbiting relies on the Exo-Brake de-orbiting device. Release of the Exo-Brake will result in de-orbiting in approximately 26 weeks with no disposal or de-orbiting actions required.

Case 2: Failed Deployment

TechEdSat-7 de-orbiting does not rely on de-orbiting devices. Release with a downward, retrograde vector will result in de-orbiting in approximately 5 years with no disposal or de-orbiting actions required.

ODAR Section 7: Assessment of Spacecraft Reentry Hazards

Assessment of spacecraft compliance with Requirement 4.7-1:

Requirement 4.7-1. Limit the risk of human casualty: The potential for human casualty is assumed for any object with an impacting kinetic energy in excess of 15 joules:

- a. For uncontrolled reentry, the risk of human casualty from surviving debris shall not exceed 0.0001 (1:10,000) (Requirement 56626).

Summary Analysis Results: DAS v2.1 reports that TechEdSat-7 is compliant with the requirement. It predicts that no components on board has more than 15 joules of impact kinetic energy. The majority of TechEdSat-7 including its components and the Exo-Brake will burn up on re-entry. As seen in the analysis outputs below, the highest impact kinetic energies is 0 Joules. Also, there are no titanium components that will be used on TechEdSat-7.

10 27 2017; 16:50:56PM *****Processing Requirement 4.7-1
Return Status : Passed

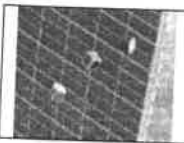

TechEdSat-7
Orbital Debris Assessment Report (ODAR)

**T7MP-06-
XS001 Rev 2**



*****INPUT*****

Item Number = 1

name = TES7
quantity = 1
parent = 0
materialID = 8
type = Box
Aero Mass = 2.500000
Thermal Mass = 2.500000
Diameter/Width = 0.100000
Length = 0.217000
Height = 0.100000

name = Door Assembly
quantity = 1
parent = 1
materialID = 8
type = Flat Plate
Aero Mass = 0.083000
Thermal Mass = 0.083000
Diameter/Width = 0.100000
Length = 0.100000

name = Ejection Plate Assembly
quantity = 1
parent = 1
materialID = 77
type = Box
Aero Mass = 0.145000
Thermal Mass = 0.145000
Diameter/Width = 0.100000
Length = 0.100000
Height = 0.044000

name = Lower Stack Assembly
quantity = 1
parent = 1
materialID = 8
type = Box
Aero Mass = 1.512000
Thermal Mass = 1.140000
Diameter/Width = 0.100000
Length = 0.100000
Height = 0.050000

name = Battery
quantity = 2
parent = 4
materialID = 70

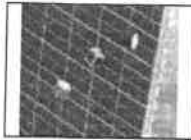

TechEdSat-7
Orbital Debris Assessment Report (ODAR)

**T7MP-06-
XS001 Rev 2**



type = Box
Aero Mass = 0.186000
Thermal Mass = 0.186000
Diameter/Width = 0.040000
Length = 0.075000
Height = 0.040000

name = Upper Stack Assembly
quantity = 1
parent = 1
materialID = 58
type = Box
Aero Mass = 0.142500
Thermal Mass = 0.031500
Diameter/Width = 0.030000
Length = 0.030000
Height = 0.015000

name = Crayfish
quantity = 1
parent = 6
materialID = 23
type = Flat Plate
Aero Mass = 0.035000
Thermal Mass = 0.035000
Diameter/Width = 0.100000
Length = 0.100000

name = Adam 12 Power Board
quantity = 1
parent = 6
materialID = 4
type = Flat Plate
Aero Mass = 0.076000
Thermal Mass = 0.076000
Diameter/Width = 0.300000
Length = 0.400000

name = Solar Panel
quantity = 4
parent = 1
materialID = 23
type = Flat Plate
Aero Mass = 0.053000
Thermal Mass = 0.053000
Diameter/Width = 0.100000
Length = 0.157500

name = Structure
quantity = 1



TechEdSat-7
Orbital Debris Assessment Report (ODAR)

T7MP-06-
XS001 Rev 2



parent = 1
materialID = 8
type = Box
Aero Mass = 0.370000
Thermal Mass = 0.370000
Diameter/Width = 0.100000
Length = 0.217000
Height = 0.100000

name = ExoBrake
quantity = 1
parent = 1
materialID = 44
type = Flat Plate
Aero Mass = 0.135500
Thermal Mass = 0.135500
Diameter/Width = 1.250000
Length = 1.250000

*****OUTPUT****

Item Number = 1

name = TES7
Demise Altitude = 77.995979
Debris Casualty Area = 0.000000
Impact Kinetic Energy = 0.000000

name = Door Assembly
Demise Altitude = 76.112137
Debris Casualty Area = 0.000000
Impact Kinetic Energy = 0.000000

name = Ejection Plate Assembly
Demise Altitude = 77.550102
Debris Casualty Area = 0.000000
Impact Kinetic Energy = 0.000000

name = Lower Stack Assembly
Demise Altitude = 65.798409
Debris Casualty Area = 0.000000
Impact Kinetic Energy = 0.000000

name = Battery
Demise Altitude = 64.908737
Debris Casualty Area = 0.000000
Impact Kinetic Energy = 0.000000

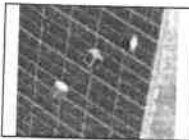

TechEdSat-7
Orbital Debris Assessment Report (ODAR)

**T7MP-06-
XS001 Rev 2**

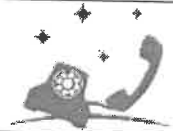

name = Upper Stack Assembly
Demise Altitude = 73.529701
Debris Casualty Area = 0.000000
Impact Kinetic Energy = 0.000000

name = Crayfish
Demise Altitude = 73.024727
Debris Casualty Area = 0.000000
Impact Kinetic Energy = 0.000000

name = Adam 12 Power Board
Demise Altitude = 73.255264
Debris Casualty Area = 0.000000
Impact Kinetic Energy = 0.000000

name = Solar Panel
Demise Altitude = 77.472542
Debris Casualty Area = 0.000000
Impact Kinetic Energy = 0.000000



name = Structure
Demise Altitude = 76.177994
Debris Casualty Area = 0.000000
Impact Kinetic Energy = 0.000000

name = ExoBrake
Demise Altitude = 77.988823
Debris Casualty Area = 0.000000
Impact Kinetic Energy = 0.000000

=====
===== End of Requirement 4.7-1 =====

Requirements 4.7-1b and 4.7-1c below are non-applicable requirements because TechEdSat-7 does not use controlled reentry.

4.7-1, b) NOT APPLICABLE. For controlled reentry, the selected trajectory shall ensure that no surviving debris impact with a kinetic energy greater than 15 joules is closer than 370 km from foreign landmasses, or is within 50 km from the continental U.S., territories of the U.S., and the permanent ice pack of Antarctica (Requirement 56627).

	TechEdSat-7 Orbital Debris Assessment Report (ODAR)	T7MP-06- XS001 Rev 2	
---	--	---------------------------------------	---

4.7-1 c) **NOT APPLICABLE.** For controlled reentries, the product of the probability of failure of the reentry burn (from Requirement 4.6-4.b) and the risk of human casualty assuming uncontrolled reentry shall not exceed 0.0001 (1:10,000) (Requirement 56628).

ODAR Section 8: Assessment for Tether Missions

Requirement 4.8-1. Mitigate the collision hazards of space tethers in protected regions of space: Intact and remnants of severed tether systems in Earth, lunar, or Mars orbit, in the Sun-Earth Lagrange Points, or in the Earth-Moon Lagrange Points shall limit the generation of orbital debris from on-orbit collisions with other operational spacecraft.

Not applicable. There are no tethers in the TechEdSat-7 mission.

ODAR Sections 9-14: Launch Vehicle

Since the TechEdSat-7 launch vehicle is managed by Virgin Orbit the orbital debris assessment for the launch vehicle will be performed by Virgin Orbit. The following note from NPR 8715.6A, Paragraph P.2.2, is applied, "*Note: It is recognized that NASA has no involvement or control in the design or operation of Federal Aviation Administration (FAA)-licensed launches or foreign or Department of Defense (DoD)-furnished launch services, and, therefore, these are not subject to the requirements in this NPR for the launch portion.*"

END of ODAR for TechEdSat-7.

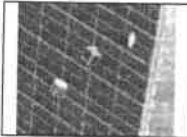

Appendix A: Acronyms

AFRL	Air Force Research Lab
ARC	Ames Research Center
Arg peri	Argument of Perigee
CDR	Critical Design Review
cm	centimeter
COTS	Commercial Off-The-Shelf (items)
DAS	Debris Assessment Software
EOM	End Of Mission
ESMD	Exploration Systems Mission Directorate
FRR	Flight Readiness Review
GEO	Geosynchronous Earth Orbit
ITAR	International Traffic In Arms Regulations
kg	kilogram
km	kilometer
LEO	Low Earth Orbit
Li-Ion	Lithium Ion
m ²	Meters squared
ml	milliliter
mm	millimeter
N/A	Not Applicable.
ODAR	Orbital Debris Assessment Report
TechEdSat-7	Technical Education Satellite-6
ORR	Operations Readiness Review
OSMA	Office of Safety and Mission Assurance
PDR	Preliminary Design Review
PL	Payload
P-POD	Poly Picosatellite Orbital Deployer
PSIa	Pounds Per Square Inch, absolute
PSRR	Pre-Ship Readiness Review
RAAN	Right Ascension of the Ascending Node
SESLO	Space environment survivability of live organisms (payload)
SMA	Safety and Mission Assurance
Ti	Titanium
USAF	United States Air Force
UTJ	Ultra Triple Junction
yr	year

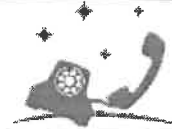
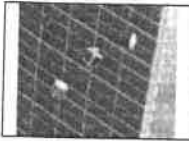

Appendix B: Battery Data Sheet

MATERIAL SAFETY DATA SHEET

Page 1 of 2
MSDS# BA0035-01-090218

SECTION 1 IDENTIFICATION OF THE SUBSTANCE/MIXTURE AND OF THE COMPANY/UNDERTAKING

Product Name: Lithium Ion Battery

Product Code: BP-930

Company Name: Canon Inc.

Address: 30-2, Shimomaruko 3-Chome, Ohta-ku, Tokyo 146-8501, Japan

Use of the Product: Battery for Video camera

Supplier: _____

Address: _____

Phone number: _____

With regard to air transport, the International Civil Aviation Organization (ICAO) Packing Instruction 965 Part 1 complies with the Recommendation as is; further, the International Air Transport Association (IATA) adopts ICAO Packing Instruction 965 Part 1. In addition, the regulations of the US Department of Transportation for land, sea and air transportation are based on the UN Recommendations.

SECTION 2 MATERIALS AND INGREDIENTS INFORMATION

IMPORTANT NOTE: The battery pack uses four US 18650S lithium-ion rechargeable cells and control circuit on the PWB.

The cells are connected in 2 parallel strings of 2 cells in series.

The battery pack should not be opened or burned since the following ingredients contained within the cells could be harmful under some circumstance if exposed or misused.

The cells contain neither metallic lithium nor lithium alloy.

Cathode:	Lithium-Cobalt Dioxides (active material)
	Polyvinylidene Fluoride (binder)
	Graphite (conductive material)
Anode:	Graphite (active material)
	Polyvinylidene Fluoride (binder)
Electrolyte:	Organic Solvent (non-aqueous liquid)
	Lithium Salt
Others:	Heavy metals such as Mercury, Cadmium, Lead, and Chromium are not used in the cells.
Enclosure:	Plastic (PC)

SECTION 3 FIRE HAZARD DATA

In case of fire, use CO₂ or dry chemical extinguishers.

Date of Issue: September 8, 2009

Revised Date: -

Ver. 2009/6/01



TechEdSat-7
Orbital Debris Assessment Report (ODAR)

**T7MP-06-
 XS001 Rev 2**

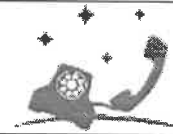

MATERIAL SAFETY DATA SHEET

Page 2 of 2
 MSDS#:BA0035-01-090218

SECTION 4 HEALTH HAZARD DATA

Under normal condition of use, these chemicals are contained in sealed can. Risk of exposure occurs only if the cells are mechanically abused.

- Inhalation: Contents of an opened cell can cause respiratory irritation.
 Remove to fresh air immediately and call a doctor.
- Skin Contact: Contents of an opened cell can cause skin irritation.
 Wash skin with soap and water.
- Eye Contact: Contents of an opened cell can cause eye irritation.
 Immediately flush eyes thoroughly with water for at least 15 minutes. Seek medical attention.

SECTION 5 PRECAUTIONS FOR SAFE HANDLING AND USE

- Storage: Store within the recommended limit of -20 degrees C to 45 degrees C (-4 degrees F to 113 degrees F), well-ventilated area.
 Do not expose to high temperature (60 degrees C/140 degrees F). Since short circuit can cause burn hazard or safety vent to open, do not store with metal jewelry, metal covered tables, or metal belt.
- Handling: Do not disassemble, remodel, or solder. Do not short + and - terminals with a metal. Do not open the battery pack.
- Charging: Charge within the limits of 0 degrees C to 40 degrees C (32 degrees F to 104 degrees F) temperature.
 Charge with specified charger designed for this battery pack.
- Discharging: Discharge within the limits of -10 degrees C to 50 degrees C (14 degrees F to 122 degrees F) temperature.
- Disposal: Dispose in accordance with applicable federal, state and local regulation.
- Caution: Attach the cover to the battery pack to prevent short circuits.
 Do not disassemble. Do not incinerate. Do not expose to temperature above 140 degrees F.

SECTION 6 SPECIAL PROTECTION INFORMATION

- Respiratory Protection: Not necessary under normal use.
- Ventilation: Not necessary under normal use.
- Eye Protection: Not necessary under normal use.
- Protective Gloves: Not necessary under normal use.

Date of Issue: September 8, 2009

Revised Date: -

Ver. 2009/6/01

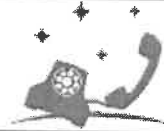
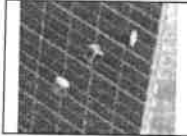

Appendix C: Wiring Schematics

TechEdSat-7 Wiring Diagram

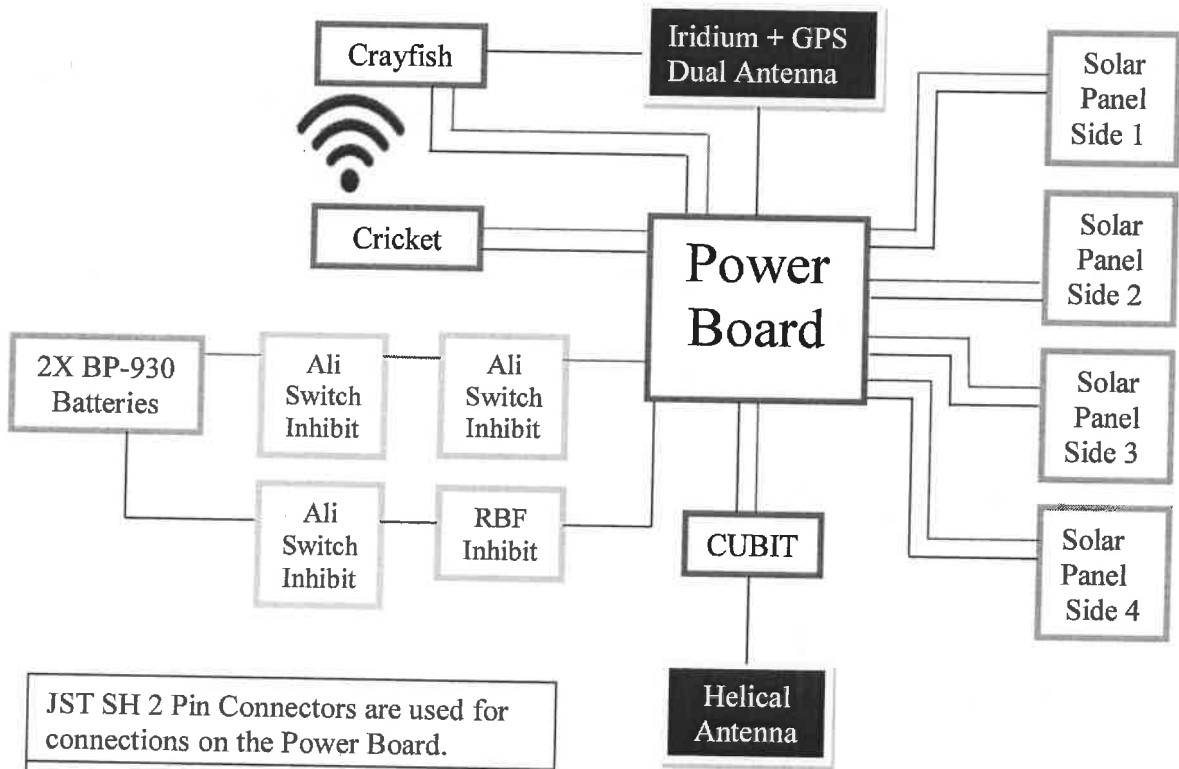

JST SH 2 Pin Connectors are used for connections on the Power Board.

MCX Connections are used for the GPS antenna, while MMCX Connections are used for the Iridium and U.FL Connections are used for the CUBIT.

Wire-to-wire connections use Molex connectors.

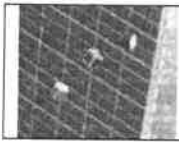

Second Cricket and CUBIT Wiring Diagram

