

ELVL-2017-0044671
November 22, 2017

**Orbital Debris Assessment for
The CubeSats on the
ELaNa-XIX Mission
per NASA-STD 8719.14A
(NASA HQ) Rev B**

Signature Page



Yusuf Johnson, Reviewer, NASA KSC VA-G2



Justin Treptow, Analyst & Mission Manager, NASA KSC VA-G2

Nov 23, 17

National Aeronautics and
Space Administration

John F. Kennedy Space Center, Florida
Kennedy Space Center, FL 32899



ELVL-2017-0044671

Reply to Attn of: VA-H1

November 22, 2017

TO: Justin Treptow, LSP Mission Manager, NASA/KSC/VA-G2

FROM: Justin Treptow, NASA/KSC/VA-G2

SUBJECT: Orbital Debris Assessment Report (ODAR) for the ELaNa-XIX Mission
(NASA HQ) Rev B

REFERENCES:

- A. *NASA Procedural Requirements for Limiting Orbital Debris Generation*, NPR 8715.6A, 5 February 2008
- B. *Process for Limiting Orbital Debris*, NASA-STD-8719.14A, 25 May 2012
- C. Armstrong, Jason; TriSept Corp. "ODAR info" email, Oct 20, 2016.
- D. McKissock, Barbara, Patricia Loyselle, and Elisa Vogel. *Guidelines on Lithium-Battery Use in Space Applications*. Tech. no. RP-08-75. NASA Glenn Research Center Cleveland, Ohio
- E. *UL Standard for Safety for Lithium Batteries, UL 1642*. UL Standard. 4th ed. Northbrook, IL, Underwriters Laboratories, 2007
- F. Kwas, Robert. Thermal Analysis of ELaNa-4 CubeSat Batteries, ELVL-2012-0043254; Nov 2012
- G. Range Safety User Requirements Manual Volume 3- Launch Vehicles, Payloads, and Ground Support Systems Requirements, AFSCM 91-710 V3.
- H. HQ OSMA Policy Memo/Email to 8719.14: CubeSat Battery Non-Passivation, Suzanne Aleman to Justin Treptow, 10, March 2014
- I. *Electron LV-Payload Interface Control Document*, ELVL-2016-0044579, Received October 24, 2016

The intent of this report is to satisfy the orbital debris requirements listed in ref. (a) for the ELaNa-19 primary mission payload. It serves as the final submittal in support of the spacecraft Safety and Mission Success Review (SMSR). Sections 1 through 8 of ref. (b) are addressed in this document; sections 9 through 14 fall under the requirements levied on the primary mission and are not presented here.

The following table summarizes the compliance status of the ELaNa XIX (ELana-19) auxiliary payload mission flown on ELaNa-19. The fourteen CubeSats comprising the ELaNa-19 mission are fully compliant with all applicable requirements.

Rev B:

- Updates the ODAR with the removal of GEOSTare and replaces them with ALBus.
- Updates CHOMPTT battery holder survivability analysis resulting in a 6J reentry energy for those component.
- Additional CONOPs have been updated for CubeSail identifying deployment of the system. All details alleviate concerns and strengthen their compliance with the NASA Orbital Debris policy.
- ANDESITE Nodes have been added into orbit lifetime calculations, Probability of Collision, and mission deployment CONOPS. All details alleviate concerns and strengthen their compliance with the NASA Orbital Debris policy.

Table 1: Orbital Debris Requirement Compliance Matrix

Requirement	Compliance Assessment	Comments
4.3-1a	Not applicable	No planned debris release
4.3-1b	Not applicable	No planned debris release
4.3-2	Not applicable	No planned debris release
4.4-1	Compliant	On board energy source (batteries) incapable of debris-producing failure
4.4-2	Compliant	On board energy source (batteries) incapable of debris-producing failure
4.4-3	Not applicable	No planned breakups
4.4-4	Not applicable	No planned breakups
4.5-1	Compliant	
4.5-2	Not applicable	
4.6-1(a)	Compliant	Worst case lifetime 5.9 yrs
4.6-1(b)	Not applicable	
4.6-1(c)	Not applicable	
4.6-2	Not applicable	
4.6-3	Not applicable	
4.6-4	Not applicable	Passive disposal
4.6-5	Compliant	
4.7-1	Compliant	Non-credible risk of human casualty
4.8-1	Compliant	ELaNa-19 includes the CubeSail mission, containing a 250m solar sail / tether

Section 1: Program Management and Mission Overview

The ELaNa-19 mission is sponsored by the Human Exploration and Operations Mission Directorate at NASA Headquarters. The Program Executive is Jason Crusan. Responsible senior scientific / management personnel are as follows:

ANDESITE: Walsh Brian, Principle Investigator

CeREs: Summerlin Errol, Principle Investigator

CHOMPPTT: Conklin John, Principle Investigator

CubeSail: Carroll David, Principle Investigator

DaVinci: Finman Lorna, Principle Investigator

ISX: Bellardo John, Principle Investigator

NMTSat: Jorgensen Anders, Principle Investigator

RSat: Kang Jin, Principle Investigator

Shields-1: Thomsen Laurence, Principle Investigator

STF-1: Grubb Matthew, Principle Investigator

TOMSat EAGLESCOUT: Hattersley Bonnie, Principle Investigator

TOMSat R3: Hattersley Bonnie, Principle Investigator

GEOStare: de Vries Wim, Principle Investigator

SHFT-1: Lux Jim, Principle Investigator

ALBus: Kathryn Shaw, Project Manager

Program Milestone Schedule	
Task	Date
CubeSat Selection	CSLI award February 2016
CubeSat Mission Readiness review:	December 4-7th 2017
CubeSat delivery to TriSept	January 2018
CubeSat integration with LV	February 2018
Launch date	March 1, 2018

Figure 1: Program Milestone Schedule

The ELaNa-19 mission will be launched as the primary payload on the VCLS RocketLabs ELaNa-19 mission on an US made Electron launch vehicle from New Zealand range. The ELaNa-19 compliment, will deploy 14 pico-satellites (or CubeSats). The CubeSat slotted position is identified in Table 2: ELaNa-19 CubeSats. The ELaNa-19 manifest includes: ANDESITE, CeREs, CHOMPPTT , CubeSail, DaVinci, ISX, NMTSat, RSat, Shields-1, STF-1, TOMSat EAGLESCOUT, TOMSat R3, SHFT-1, and ALBUS. The current launch date opens March 1, 2018 extending till April 15, 2018. The 14 CubeSats are to be ejected from the Electron shortly after the launch, placing the CubeSats in an orbit approximately 500 X 500 km at inclination of 85 deg (ref. (i)).

Each CubeSat ranges in sizes from a 10 cm x 10cm x 30 cm to 10 cm x 20 cm x 30 cm, with masses from about 1.56 kg to ~5.13 kg total. The CubeSats have been designed and universities and government agencies and each has their own mission goals.

Section 2: Spacecraft Description

There are 14 CubeSats flying on the ELaNa-19 Mission. Table 2: ELaNa-19 CubeSats outlines their generic attributes.

Table 2: ELaNa-19 CubeSats

CubeSat Quantity	CubeSat size	CubeSat Names	CubeSat Masses (kg)
1	6U (24 cm x 36.3 cm x 11 cm)	ANDESITE	5.13
1	3U (10 cm x 10 cm x 34 cm)	CeREs	4.56
1	3U (10 cm x 10 cm x 34 cm)	CHOMPPTT	1.56
1	3U (10 cm x 10 cm x 31 cm)	CubeSail	3.52
1	3U (11.7 cm x 11.3 cm x 34.05 cm)	DaVinci	3.36
1	3U (11.2 cm x 11.1 cm x 34.05 cm)	ISX	3.70
1	3U (10 cm x 10 cm x 34 cm)	NMTSat	1.58
1	3U (11.3 cm x 11.3 cm x 34.05 cm)	Rsat	4.15
1	3U (10.6 cm x 10.6 cm x 34.05 cm)	Shields-1	6.94
1	3U (11.5 cm x 11.5 cm x 34.05 cm)	STF-1	3.35
1	3U (10.3 cm x 10.3 cm x 34.05 cm)	TOMSat EAGLESCOUT	4.09
1	3U (10.3 cm x 10.3 cm x 34.05 cm)	TOMSat R3	4.09
1	3U (11.3 cm x 11.2 cm x 36.6 cm)	SHFT-1	5.10
1	3U (34.05 x 11.6 x 11.6 cm ³)	ALBus	4.0

The following subsections contain descriptions of these 14 CubeSats.

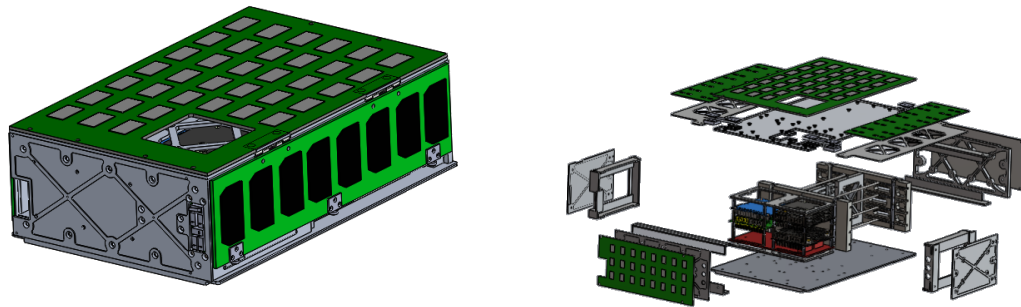

Figure 2: ANDESITE System and Expanded View

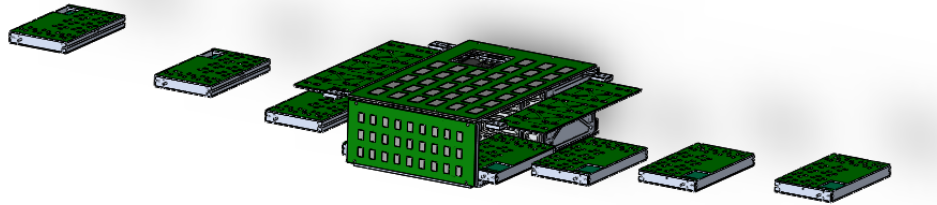

Figure 3: ANDESITE Sensor Node Deployment & Node Expanded View

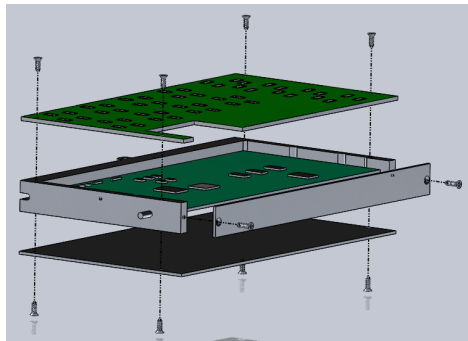

Figure 4: Sensor Node Expanded View

OVERVIEW

The design of ANDESITE relies on deploying several small “sensor nodes” from a main spacecraft—a 6U “mule” designed to comply with CubeSat Canisterized Satellite Dispenser (CSD) standards. Each sensor node holds a magnetometer that will provide three-axis magnetic field measurements with roughly ten nanotesla accuracy.

By distributing the sensor nodes spatially, the system measures relative variations of the field as it flies through the aurora. With Ampere's law from Maxwell's equations and a priori knowledge of Earth's background magnetic field we can calculate and map the current densities due to energetic charged particles moving into and out of the atmosphere in the polar regions where the aurora occurs.

CONOPS

The ANDESITE system consists of 8 identical sensor nodes, and a 6U “data mule.” All 9 satellites deploy in a single configuration called the aggregate satellite into a 500 km altitude near circular orbit at 85 degrees inclination. At this time, the aggregate satellite will enter de-tumbling mode. During this phase, the attitude control system on the 6U—designed around a three-axis magnetorquer from ISISpace—will activate and stabilize the craft using state knowledge garnered from six onboard sun sensors, gyros, and magnetometer.

While nodes will be launched with pre-charged batteries, a slow rotation rate stabilized towards sun vector will ensure that the mule batteries are at full capacity before entering the next phase of the deployment. Once de-tumbling is finished the mule will stabilize with the bottom plate nadir pointing and eject a pair of sensor nodes once per orbit cross-track near the equator.

The sensor nodes begin startup sequences the moment they are launched from the mule via a mechanical switch. After initialization device discovery occurs and the self-organizing sensor network is consolidated so that magnetometer data can be relayed back to the mule during the science mission.

The nodes drift along the orbital track due to their differing ballistic parameters and do not cross each others trajectories due to the asymmetry of the gravitational perturbations that each encounters. Within a few orbits the nodes will not come within 100 m of each other, with relative speeds of < 2 m/s. While they drift away from the main 6U spacecraft they will never deviate from the main orbital plane by more than 2.5 km with all the associated formation drift occurring in the mean anomaly or velocity direction. Therefore their chance of collision with other satellites individually remains the less than the chance calculated by the NASA ODAR for the 6U mule due to their smaller size.

Materials

The primary CubeSat structure is made of aluminum 6061. The baseplate is made of aluminum 7075 and is hard anodized. The CubeSat contains all standard commercial off the shelf (COTS) materials, electrical components, PCBs and solar cells. It has eight deployable picosatellites that eject while in orbit, and two deployable solar panel wings that deploy upon exit of the Canisterized Satellite Dispenser (CSD). The picosatellites have an aluminum 6061 structure and PCBs for solar cells and on board electronics. Stainless steel 6-32 and 2-56 screws are used to fasten the CubeSat, and helicoils are inserted for back-out protection.

Hazards

There *no* pressure vessels, hazardous or exotic materials.

Batteries

The electrical power storage system consists of common *Lithium-Ion Polymer* batteries with over-charge/current protection circuitry provided by a Clyde Space EPS. Clyde Space battery part number C3-USM-5016-CS-30Wh.

CeREs -GSFC – 3U

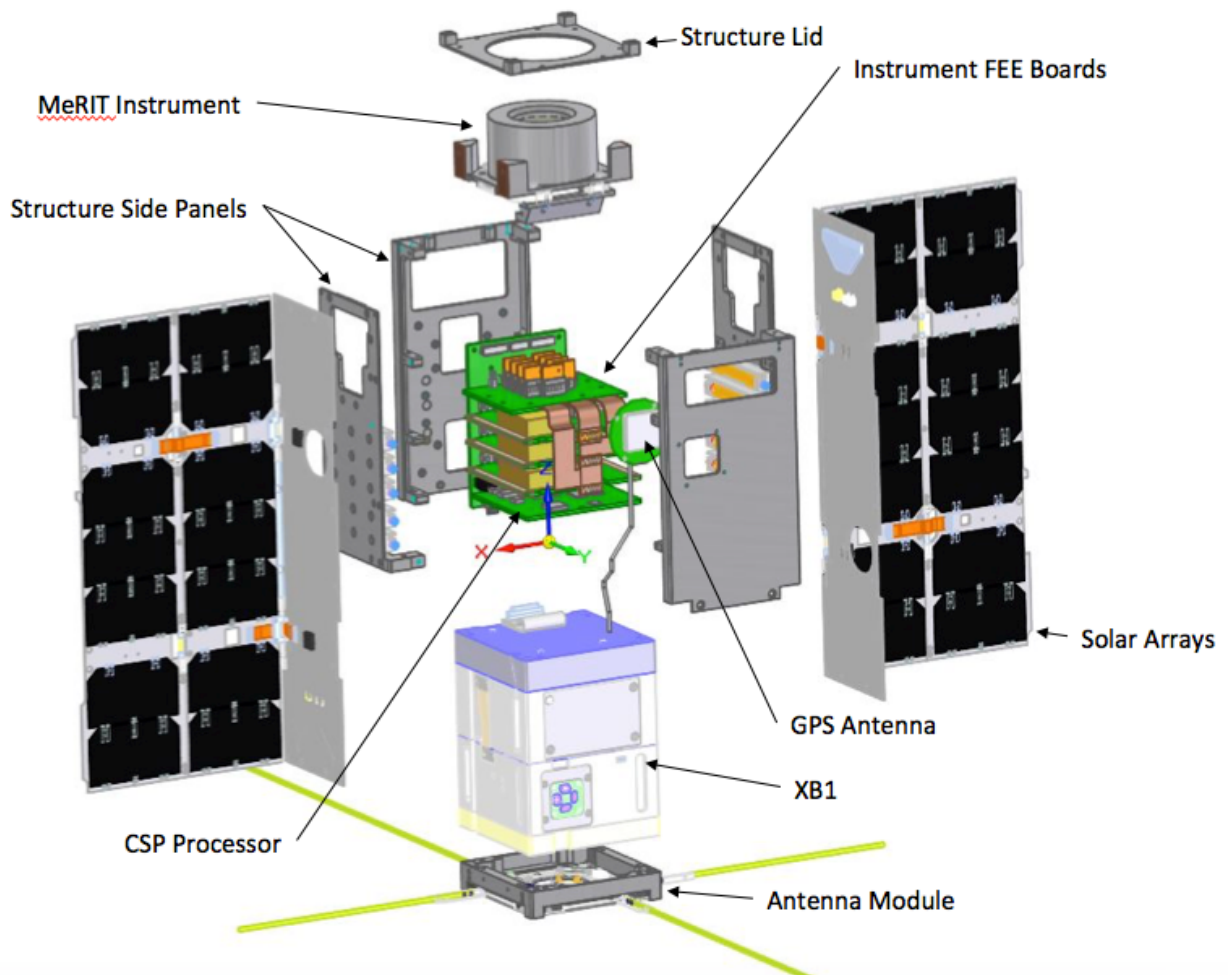

Figure 5: CeREs CubeSat Expanded View

OVERVIEW

CeREs is a 3U CubeSat carrying a single instrument to study radiation belt dynamics in support of the Van Allen Probes. Specifically, the detector, MeRIT, a combination of solid state detectors (SSDs) and avalanche photo diodes (APDs) will measure electrons with energies between 10keV and 10 MeV with extremely fast (5ms) cadence. This unprecedented measurement range comes from seamlessly combining SSD technology, sensitive to higher energy electrons with new APDs which are sensitive to lower energy electrons. The high measurement cadence is supported advanced application specific integrated circuits that can handle millions of events per second.

Electrons at these energies precipitating over the poles can have sudden bursts of intensity that last only a few microseconds called microbursts. These were first seen by the SAMPEX mission with a 20 ms cadence for electrons greater than 1 MeV, but because of the limited instrument capability, it is still unknown exactly how short these bursts can be and what the distribution of electron energies is within these events.

Microbursts have intensities an order of magnitude larger than typical rates of precipitating electrons and one of the goals of the Van Allen Probes was to investigate the origins of these events. CeREs will help Van Allen Probes achieve this objective by

providing direct measurements of precipitating electrons that can be correlated with events observed on Van Allen Probes at lower latitudes along the same magnetic field line.

CONOPS

Upon Release, CeREs will power-up, deploy its solar arrays, and enter sun acquisition mode. It will then deploy its antenna and use its GPS to decide when to “beacon” to help with initial ground contact. Once initial ground contact is established, CeREs will begin science operations. These will consist of pointing the instrument toward zenith above ~60 degrees latitude and entering a power saving/sun acquisition mode at low latitudes on the night/day side respectively. Twice per day, power permitting, the sun acquisition mode will be interrupted for a 15 minutes ground contact with WFF. As the mission continues, power levels will be monitored to ensure that sufficient time is being allocated for power acquisition daily and the 60 degree latitude value will change as solar panel efficiencies and battery power degrades. The mission will generate and transmit up to 2.7 Gb of data daily that will consist of distribution functions of energetic electrons over 3-orders of magnitude in energy. Ground contacts, data acquisition rates, and the latitude at which science operations begin are all controlled via tables uploaded to the spacecraft regularly and can be changed in response to spacecraft status.

Materials

The primary CubeSat structure is made of Aluminum 6061-T6. The detectors are made of silicon and the shielding for the detectors is made of tungsten and aluminum. Instrument front end electronics and on-board processor cards are copper and FR4. The front end electronics also have a high voltage power supply that is housed in Urethane. The XB1 avionics package, includes lithium-ion batteries, C&DH processor, L3 Cadet Radio, and the ACS system. These are housed in an aluminum shell. The solar panels contain primarily FR4 and Aluminum with steel hinges.

Hazards

There are no pressure vessels, hazardous or exotic materials.

Batteries

The electrical power storage system consists of common *Lithium-Ion* batteries with under temperature (hardware set), cell balancing, under voltage and over voltage protection features. Specs on the EPS system can be found here (http://bluecanyontech.com/wp-content/uploads/2016/07/PowerSystems_F.pdf).

CHOMPTT-University of Florida – 3U

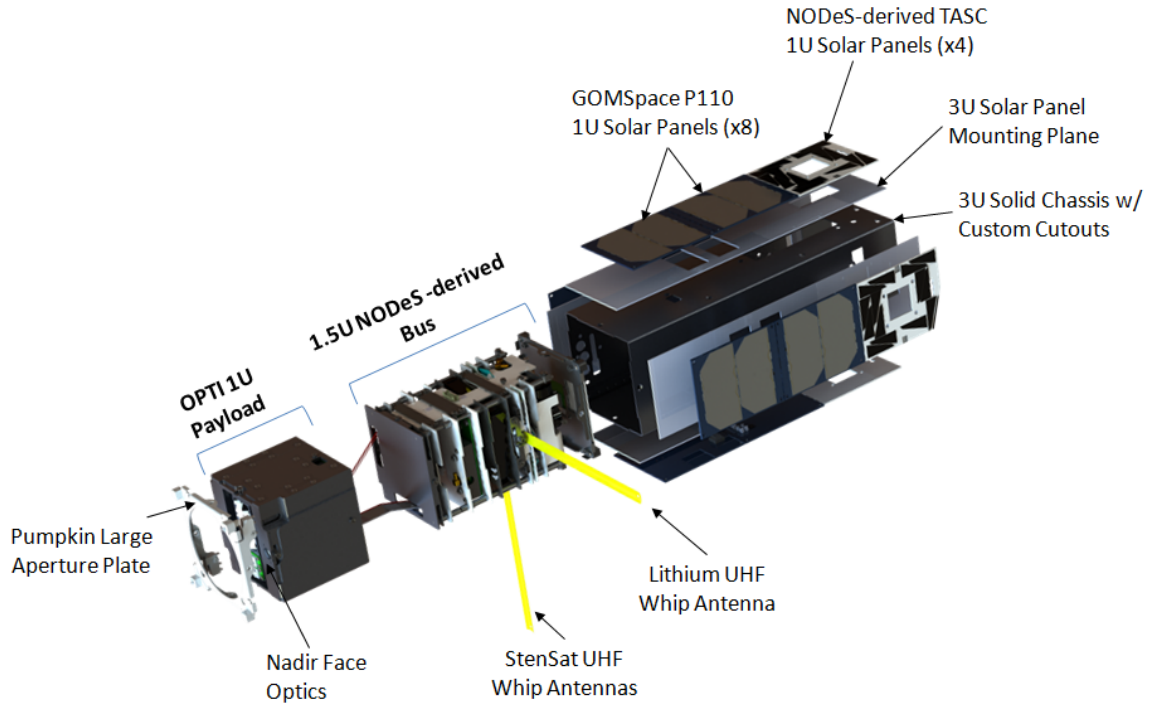

Figure 6: CHOMPTT Expanded View

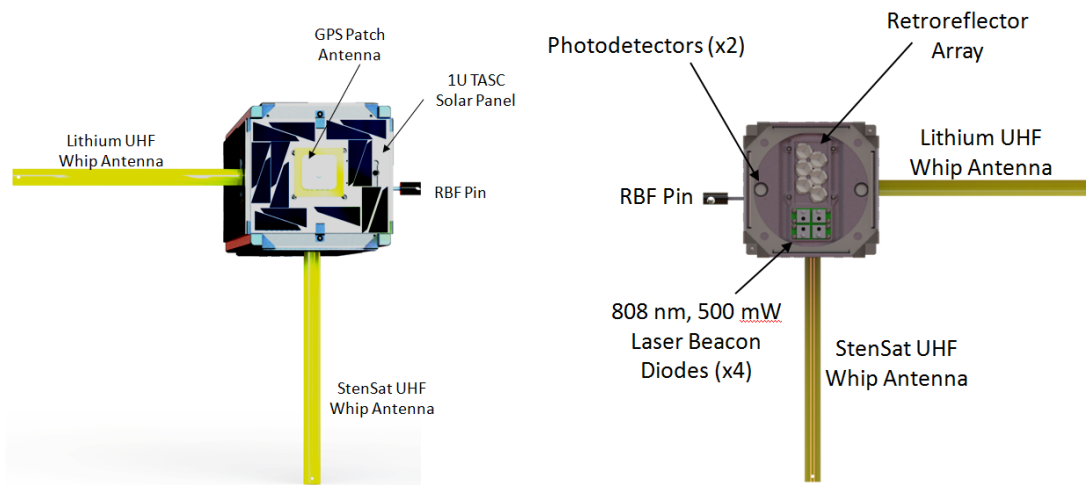

Figure 7: CHOMPTT Zenith (left) and Nadir (right) Views

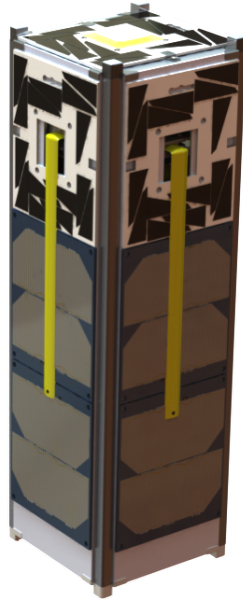

Figure 8: CHOMPTT Stowed View

Overview

CHOMPTT (CubeSat Handling of Multisystem Precision Time Transfer) is a CubeSat mission that will synchronize an atomic clock on a CubeSat with one on the ground with an accuracy of 200 ps by exchanging short laser pulses between the two. One limitation of radio frequency time-transfer is that it is susceptible to time-delay uncertainties in the ionosphere that can be difficult to model. This effect is inversely proportional to the emitted electromagnetic frequency squared and can therefore be greatly reduced by utilizing optical synchronization methods.

The CHOMPTT satellite will maintain its time with a chip scale atomic clock (CSAC). When the satellite passes over a satellite laser ranging facility (SLR), the SLR facility emits a laser pulse toward the satellite. That pulse is time-stamped with respect to the ground clock when it leaves the SLR facility and after it reflects off a retroreflector on the satellite, the returned pulse is time-stamped when it arrives back at the SLR facility with respect to the ground clock. An avalanche photodetector on the satellite simultaneously detects the pulse's arrival time and time-stamps it with respect to the clock on the satellite with an event timer. The combination of these three timing measurements provides both the range between the SLR facility and CHOMPTT and the time offset between the ground clock and the space clock.

The CHOMPTT mission is owned and operated by the University of Florida. The CHOMPTT satellite consists of a 1.5U EDSN/NODES-derived CubeSat bus and a 1U OPTI (Optical Precision Timing Instrument) payload. NASA does not claim ownership of any experimental, developmental or operational equipment that involves the use of the electromagnetic spectrum for transmission, reception, or both that is developed or procured under this contract. The University of Florida's use of any experimental, developmental or operational equipment that involves the use of the electromagnetic spectrum for transmission, reception, or both that is operated under this contract shall be under University of Florida's discretion and control; NASA does not claim any authority over the operations of the electromagnetic spectrum systems.

CONOPS

Upon deployment from the deployer, CHOMP TT will enter a safe-mode for 30 min. where all of the subsystems are nominally off. After the safe-mode period checks out, the spacecraft will power on, begin counting, beacon the spacecraft time every 60 s, and begin de-tumbling via magnetorquer for 90 min. Every 25 hour minor cycle, the spacecraft will autonomously acquire GPS data and downlink spacecraft data to the University of Florida RF ground station.

UF will coordinate with a satellite laser ranging (SLR) facility located at Kennedy Space Center to perform a time transfer and RF uplink the time transfer schedule to the spacecraft. During a time transfer, the spacecraft will point nadir, turn on the laser beacon diode for SLR tracking, and turn on all of the payload subsystems. The spacecraft will be pulsed with a laser from the SLR facility until the scheduled time transfer is over, and the spacecraft will return to its nominal counting/beacon mode.

Materials

The primary CubeSat structure is made of Aluminum and contains a 1.5U EDSN/NODEs derived bus and a 1U UF Optical Precision Timing Instrument (OPTI). The EDSN/NODEs derived bus is custom with a few commercial off the shelf (COTS) components. The custom spacecraft materials are all spacecraft PCBs, all payload components, retroreflector array, TASC 1U solar panels, structures, and reaction wheel system. The COTS spacecraft materials are the GOMSpace P110 1U solar panels with magnetorquers, MEMSpace Sun Sensors, Pumpkin large aperture plate on the 1U nadir face, GPS patch antenna, GPS radio, lithium-ion batteries, Lithium-1 Radio, and StenSat Radio.

Hazards

There are no pressure vessels, hazardous or exotic materials.

Batteries

The electrical power storage system consists of common Lithium-Ion batteries with over-charge/current protection circuitry. UL Listing information is as follows UL 1642.

CubeSail – UIUC/CUA – 3U

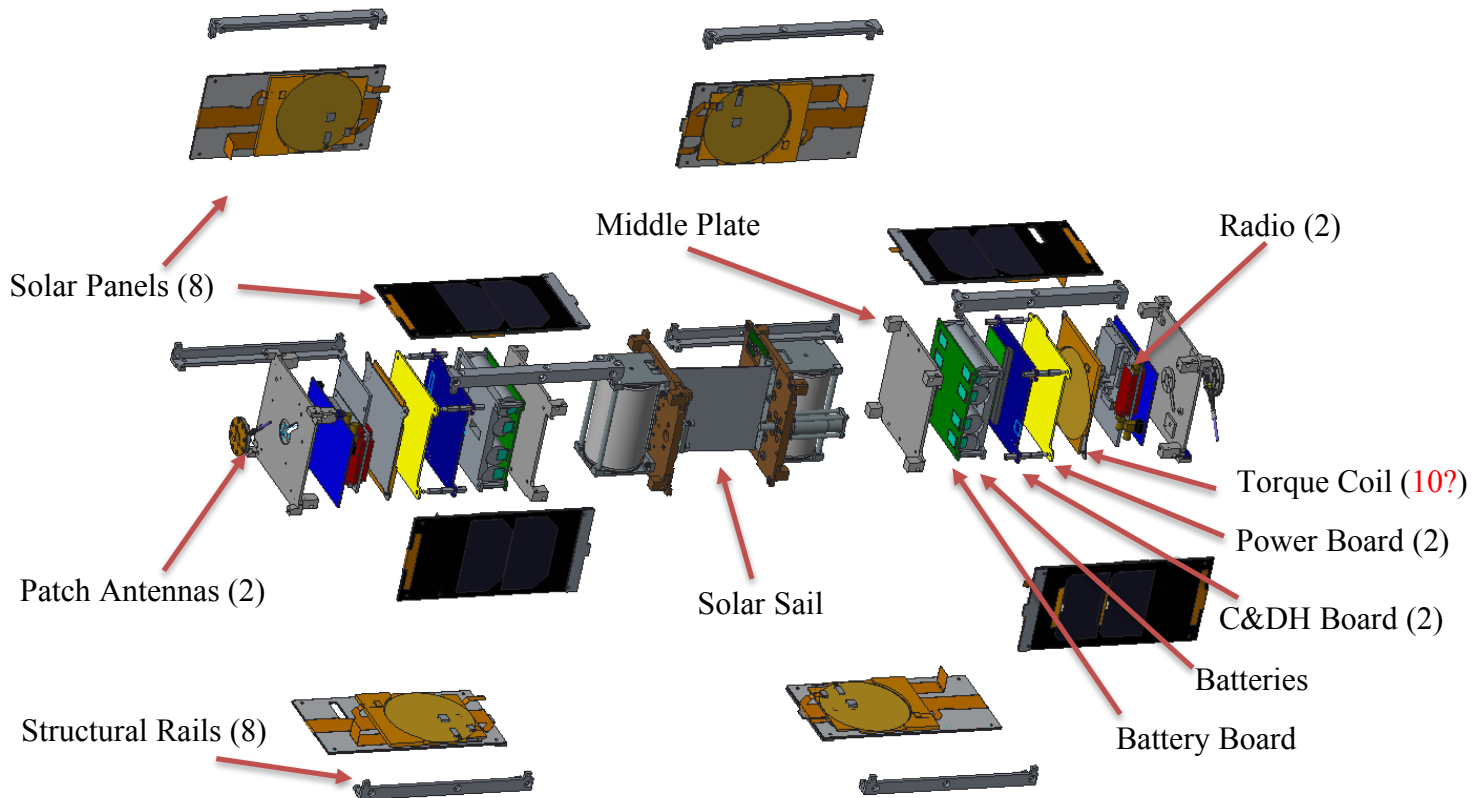

Figure 9: CubeSail Expanded View

Overview

The primary goal of the CubeSail mission is to demonstrate orbit raising from solar sail propulsion. A secondary goal is to then spin-up the satellites like a propeller with the sail extending between them. A final goal is to then deorbit the satellites using the same solar sail.

CONOPS* Additional CONOPS clarification has been provided in Rev B seen below

Following a successful launch and orbit insertion of the satellite, communication with mission control will be initiated to verify satellite functionality. Next, a detumbling maneuver utilizing the magnetic torquers will commence. Once it is stable, the solar sail deployment sequence will begin.

Upon launch, the two sections of CubeSail are rigidly coupled by the separation release unit (SRU) and flexibly coupled by the solar sail film, which has been intentionally left slack, and is wound on two bobbins, one in each section. The first step of the deployment sequence is to command the SRU motor to spin a leadscrew which will unscrew and rigidly decouple the two sections from each other. The compression springs, mounted on the payload plate, will force the satellite apart. Because the leadscrew is not located through the center of mass, there is some resultant tipping. As CubeSail's sections separate, the slack in the film is reduced. Once the leadscrew has fully cleared its threaded hole, the film is taut and the separation springs are no longer fully compressed, but still in contact with the opposite payload plate. After an interval, the tipping moment is damped by the springs.

Next, the film bobbin motors are activated to pull the sections together using the film, thus compressing the separation springs. The force required by the bobbin motors to compress the separation springs is sensed by the circuit and converted to a rotational bobbin motor film deployment speed. The bobbin motors are then activated and begin deploying film at the prescribed velocity. This velocity matches the separation velocity of the two sections, allowing them to separate freely as the sail deploys. Both sections of the satellite have a camera to capture images of the film deployment.

As the film nears full deployment, the bobbin motors are commanded to slow down incrementally to mitigate elastic effects caused by abrupt stopping of the motors, or snapping back caused by the taught film. The shape of the sail will be imaged with the cameras. Following complete film deployment, by adjusting the attitude of each of the two CubeSail sections, CubeSail will attempt to hold the sail such that its edge is ram-facing (sail approximately facing the Sun). After approximately 1 week of operation in the ram-facing configuration, the CubeSail sections will be reoriented by 90° to hold the sail face-on in the ram-facing direction (edge to the Sun) to maximize drag. The large surface area of the sail will cause CubeSail to deorbit in a short amount of time.

Mission success will be determined by successful (1) sail deployment, (2) control of the two individual buses of CubeSail, and (3) deorbit. No additional maneuvers or attempts to manipulate the sail will be made unless requested due to a conjunction risk.

Materials

Satellite structure is made from AL60601T6, while the solar panels are Carbon fiber with an aluminum backing. The CubeSail payload is significantly aluminized mylar film. PCBs are made from FR-4 and using automotive grade or worse components.

Hazards

There are no hazardous systems on board. There are no pressure vessels nor thrusters nor any chemical reactants.

Batteries

The electrical power storage system consists of common lithium-ion batteries with over-charge/current protection circuitry. The charging system incorporates an MPPT logic. The lithium batteries carry the UL-listing number MH12210.

DaVinci - LCF Enterprises – 3U

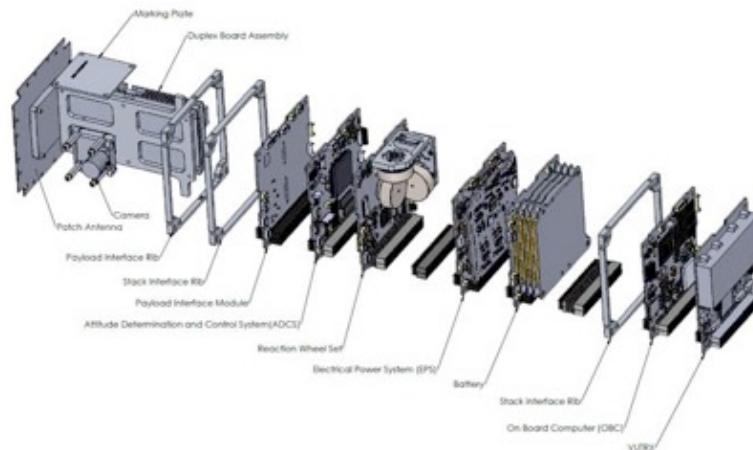

Figure 10: DaVinci Expanded View

Overview

The DaVinci mission is a 3U CubeSat being developed by North Idaho STEM Charter Academy in partnership with LCF Enterprises. The primary mission goal is STEM outreach, which will be achieved with the platform payloads. The payloads will be a basic imager to take photographs of the Earth, an amateur radio and a duplex radio modem to connect with the GlobalStar communications network. A morse code message will be communicated as the satellite orbits.

CONOPS

Upon deployment from the ISIS Quad pack, DaVinci will begin its separation sequence. All transmissions and deployments are delayed from 45 minutes from the satellite being deployed. During separation sequence the panels shall be deployed, following on from this DaVinci will minimize the platform angular rate before deploying the UHF/VHF antennas. At this point the initial communication with the ground station/globalstar network shall be made. At this point data will be analyzed to ensure a successful separation has occurred before beginning the primary mission mode. In this mode the satellite can take images and provide a link to the globalstar network via the platform Eyestar modem payload.

Materials

The primary CubeSat structure is made of *Aluminum 6082*. It contains all standard commercial off the shelf (COTS) materials, electrical components, PCBs and solar cells.

Hazards

There *are no* pressure vessels, hazardous or exotic materials.

Batteries

The electrical power storage system consists of common *Lithium Ion Polymer* batteries with over-charge/current protection circuitry. UL Listing information is as follows *UL1642*.

ISX (Ionospheric Scintillation eXplorer) – Cal Poly, SLO – 3U

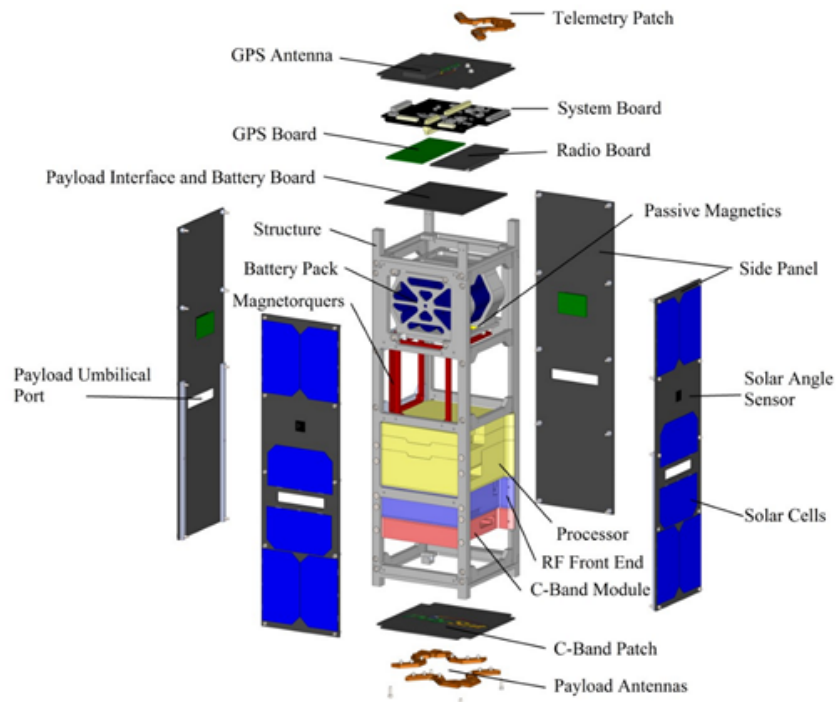

Figure 11: ISX Expanded View

Overview

The Ionospheric Scintillation eXplorer (ISX) is a satellite developed by undergraduate and graduate students as part of the PolySat research group in collaboration with SRI. The satellite is sponsored by NSF. ISX will measure the scintillation of disrupts in ionospheric plasma tubules using DTV signals. ISX will study the multi-frequency radio wave propagation properties of intermediate-to-large scale ionospheric structures of Equatorial Spread F that cause rapid phase and amplitude fluctuation of transionospheric signals.

CONOPS

Upon deployment from the PPOD, ISX will power on. Approximately 15 minutes later, the antenna will deploy. 115 minutes after antenna deployment, the beacon will be activated and the satellite will be available to acquire with the ground station. Acquisition and verification of the correct orientation and rates of the satellite will take place one week into the mission. The payload will then start taking data for one year.

Materials

The structure is made of 6061-T6 Aluminum. The antenna is made of NiTi. The antenna route is made of Delrin. It contains standard commercial off the shelf (COTS) materials, electrical components, PCBs, and solar cells.

Hazards

There are no pressure vessels, hazardous or exotic materials.

Batteries

The electrical power storage system consists of nine 3.7V 2600mAh Lithium-Ion 18650 batteries, model LR1865SK, with over-charge/current protection circuitry. There are three strings in parallel, with each string consisting of three batteries in series. UL Listing information is as follows *BBCV2.MH48285*.

NMTSat –New Mexico Institute of Mining and Technology – 3U+

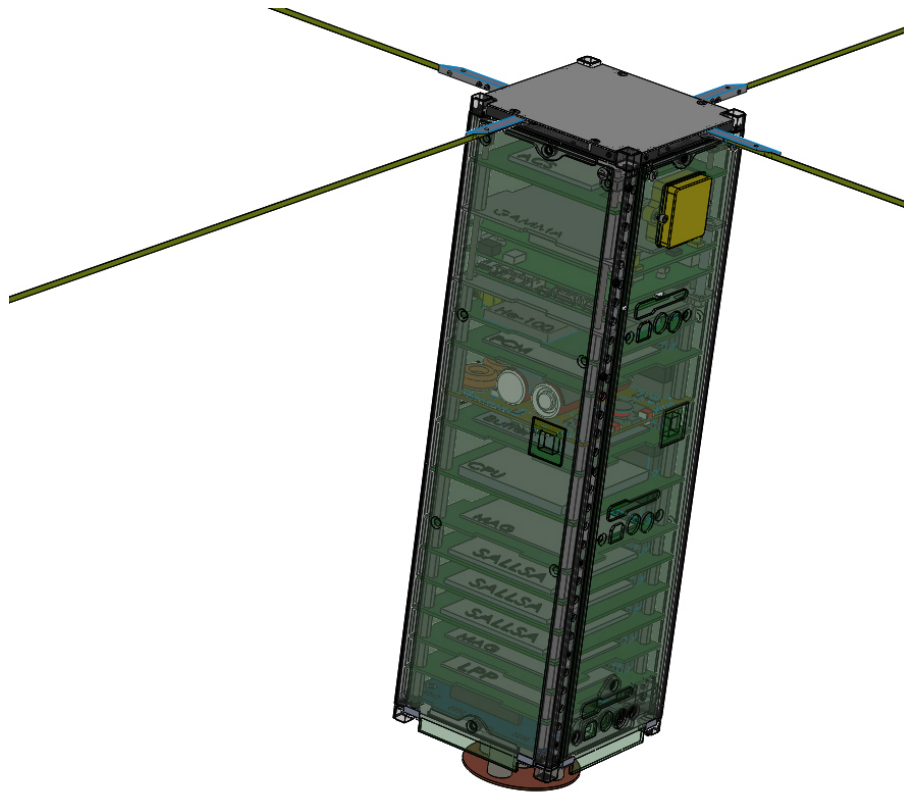

Figure 12: NMTsat Transparent View

Overview

NMTSat is a 3U+ CubeSat developed by students at New Mexico Institute of Mining and Technology. Its mission is primarily educational. NMTSat contains the following instruments or experiments: two magnetometers (MAG), one Langmuir Plasma Probe (LPP), one GPS receiver for ionospheric occultation measurements (GAMMA), one electrical health monitoring experiment (EHM) which is integrated with the power control module (PCM), and one FPGA testbed, integrated with the C&DH, one silicon neural processing experiment (SALLSA).

CONOPS

After deployment NMTSat will power up. A timer will start waiting a time (TBD) before deploying the antennas. NMTSat will then power up the PCM, including EHM, and the magnetometers and begin to collect housekeeping data from these. NMTSat will then begin to emit a identifying beacon signal for a designated amount of time and listen for commands. Ground commands to power up and down instruments are then expected as well as commands to download collected data. A watchdog timer is implemented in the power supply to power-cycle NMTSat to its initial configuration when the timer expires. Regular operation involves uplink of commands to configure the satellite and instruments, and to downlink collected data.

Materials

The primary CubeSat structure is made of Aluminum 6061. It contains all standard commercial off the shelf (COTS) materials, electrical components, PCBs and solar cells.

Hazards

There are no pressure vessels, hazardous or exotic materials.

Batteries

The electrical power storage system consists of a P31u power-management unit made by GomSpace which uses common Li- batteries with over-charge/current protection circuitry. The design is based on heritage from the satellites AAU Cubesat and AAUSAT II.

RSat - United States Naval Academy – 3U

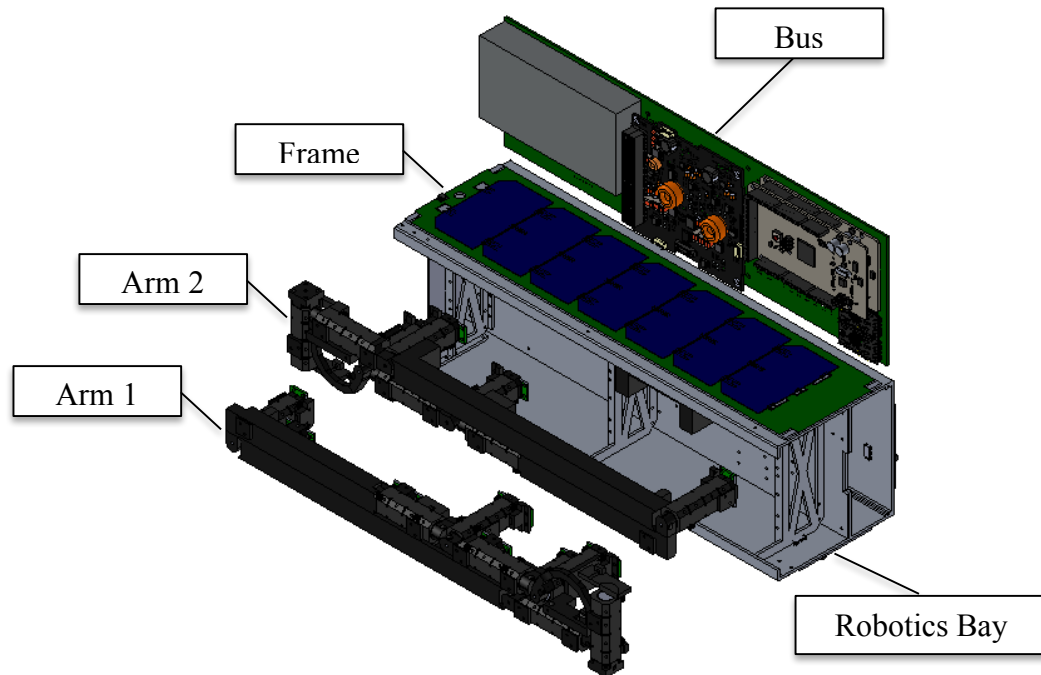

Figure 13: *RSat* Expanded View

Overview

RSat is a 3U (10 x 10 x 33 cm) cube satellite with two 60 cm, seven degree of freedom robotic arms fitted with manipulators. It is intended to latch onto a host satellite and maneuver, image, and potentially repair various components. The RSat launched through ELaNa XIX will be a free floating launch, intended to validate these capabilities and provide flight heritage and confidence for future launches.

CONOPS

Upon deployment from the PPOD, RSat will power up and attempt to deploy its antenna. It will then wait until it has detumbled to less than $1^\circ/s$ before deploying the robotic arms. After deployment, the arms will move through a series of test patterns designed to simulate various on-orbit tasks. These patterns will focus on precision, aiming for the ability to maneuver on another satellite with a minimum accuracy across the full range of motion.

Materials

The primary CubeSat structure is made of 6061 Aluminum. It contains all standard commercial off the shelf (COTS) materials, electrical components, PCBs and solar cells. The arms are made of a space suitable 3D printed material.

Hazards

There are no pressure vessels, hazardous or exotic materials.

Batteries

The electrical power storage system consists of common Lithium Ion batteries with over-charge/current protection circuitry. UL Listing information is as follows: UL1642.

Shields-1 NASA Langley Research Center – 3U

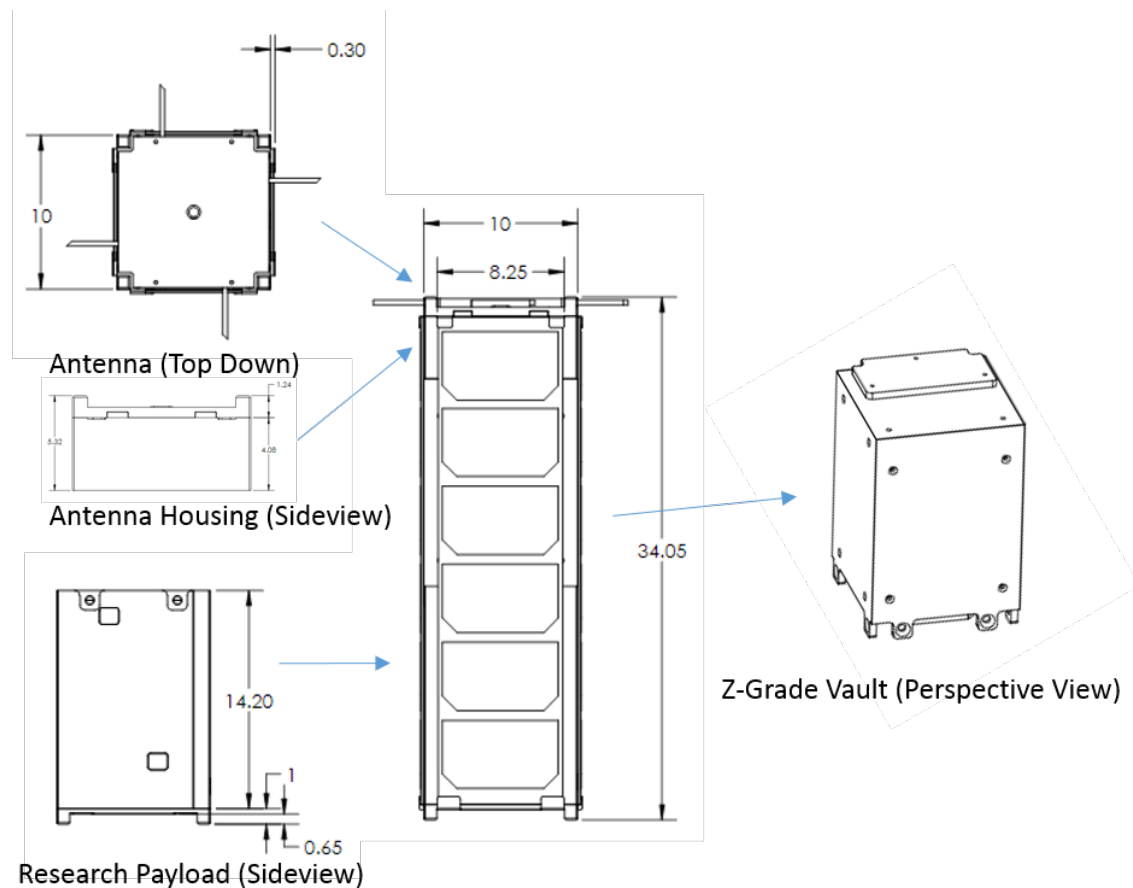

Figure 14: Shields-1 Expanded View

Overview

The Shields-1 mission with passive attitude control is a technology demonstration for radiation shielding a CubeSat electronics and a radiation shielding experiment to measure the shielding performance with respect to aluminum. There is also a charge dissipation film resistance measurement. In Figure 1, there is a vault for the flight system electronics and a research payload. The satellite is a standard 3U form factor, approximately 10cm x 10cm x 34 cm and weighs 6.9 Kg. The vault section of the CubeSat takes approximately 1.2U of the 3U, with the rest of the area the research payload, which contains the shielding and charge dissipation film resistance experiments. The satellite has four Lithium-Ion batteries. Solar panels cover all 4 3U faces for battery charging. The satellite has an aluminum/ titanium/ tantalum structure for its vault. The research payload structure is made of aluminum with 2 aluminum/ titanium/ tantalum shielding samples and one aluminum titanium sample. During the 1 year mission, the satellite will take dosimetry data from 8 μ dosimeters behind various shielding thicknesses, charge dissipation film resistance measurements, and experimental thermal measurements. The satellite will also be taking light and temperature readings from solar panel sensors.

The satellite has a turnstile antenna system by ISIS AntS-A up to 55cm in length for each antenna, deployed after the launch vehicle ejects the satellites into orbit. The turnstile antennas are the only protrusions from the flat faces of the satellites (see Figure 1 above).

CONOPS

Upon deployment from the PPOD, *Shields-1* will power up after a 30 minute software timer delay and deploy the turnstile antenna. It will slowly self-orient its long axis in the direction of magnetic field lines over a period of days and spin using passive magnetic attitude control. The ground station is located at Wallops Island, Virginia. Upon initial ground station communication with Wallops Island, *Shields-1*, *Mission Objective A*, the *Shields-1* Atomic Number (Z) Grade Radiation Shielding Research Experiments using total ionizing dose measurements with 7 μ dosimeters in the Research Payload and 1 μ dosimeter in the Vault along with thermal measurements, Figure 1, will be turned on and data will be collected four times per orbit. *Mission Objective B*, the vault μ dosimeter, thermal and system telemetry measurements, including solar panel thermal and photodiode measurements will be combined to analyze the commercial system flight boards' performance. *Mission Objective C*, the charge dissipation film resistance and thermal measurements will be taken a minimum of one time daily after the initial communication with the spacecraft. *Mission Objectives A, B, and C* are planned to last for at least a year.

Materials

The primary CubeSat research payload structure and antenna housing is made from aluminum, Figure 1. The Z-Grade Vault, figure 1, contains the FCPU and radio board, battery board, EPS, and two research payload boards. The Z-grade Vault is made of aluminum, titanium, and tantalum. There are two Z-grade radiation shielding material samples in the research payload section of the spacecraft, Figure 1. The charge dissipation film experiment, which is housed in the antenna housing structure, figure 1, contains 4 stainless steel electrodes, inside a commercial Ultem plastic housing. The *Shields-1* electronics contains all standard commercial off the shelf (COTS) materials, electrical components, PCBs and solar cells.

Hazards

There are no pressure vessels, hazardous or exotic materials.

Batteries

The electrical power storage system consists of common Lithium Ion batteries with over-charge/current protection circuitry. UL Listing information is as follows: UL 1642.

STF-1 NASA IV&V and West Virginia University – 3U

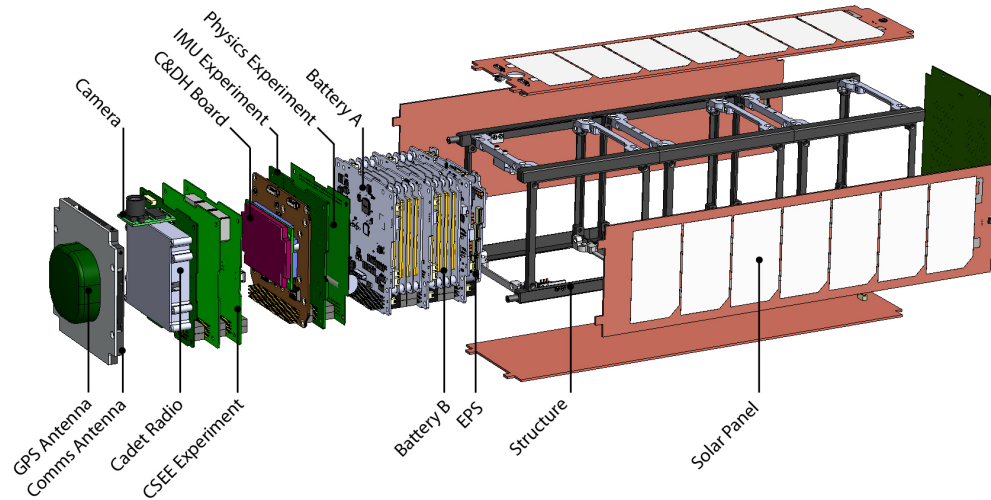

Figure 15: STF-1 Expanded View

Overview

The NASA IV&V objective of Simulation-to-Flight 1 (STF-1), is to demonstrate the utility of the NASA Operational Simulator for Small Satellites across the CubeSat development cycle, from concept planning to mission operations. The STF-1 mission will demonstrate a highly portable simulation and test platform that allows seamless transition of mission development artifacts to flight products.

The experimental objectives of this mission are to advance engineering and physical-science research currently being developed at West Virginia University (WVU). Specifically, the STF-1 mission aims to enhance precise orbit determination with commercial GPS receivers, increase IMU performance in the CubeSat form-factor, test the durability and radiation tolerance of III-V Nitride based LEDs, and measure dynamic properties of the ionospheric plasma system.

CONOPS

Upon deployment from the PPOD, STF-1 will enter the power-up sequence and hold for 30 minutes before deployment of the UHF and Langmuir probe elements. 45 minutes after deployment from the PPOD the UHF radio will be activated for telemetry to be transmitted to the Wallops Island ground station. After initial checkout with the ground station, and at which point the solar panels have sufficiently charged the batteries, STF-1 will enter the experimental mode. In this mode the spacecraft will make decisions on which experiment to execute, based on its position, power available, and experiment priority. The highest priority experiment at the beginning of the operations will be the LED experiment, in order to provide a baseline measurement of the LED performance to be compared with subsequent measurements.

Materials

The primary structure is made of Aluminum 6082, with body mounted solar panels assembled from PCBs, Kapton adhesive, and commercial solar cells. Internally are a combination of commercial off the shelf (COTS) materials, electrical components, PCBs, and experimental payloads developed at WVU.

Hazards

There are no pressure vessels, hazardous or exotic materials.

Batteries

The electrical power storage system consists of common Lithium Ion Polymer batteries with over-charge/current protection circuitry.

TOMSat: EAGLESCOUT / R3 - Aerospace Corporation -3U

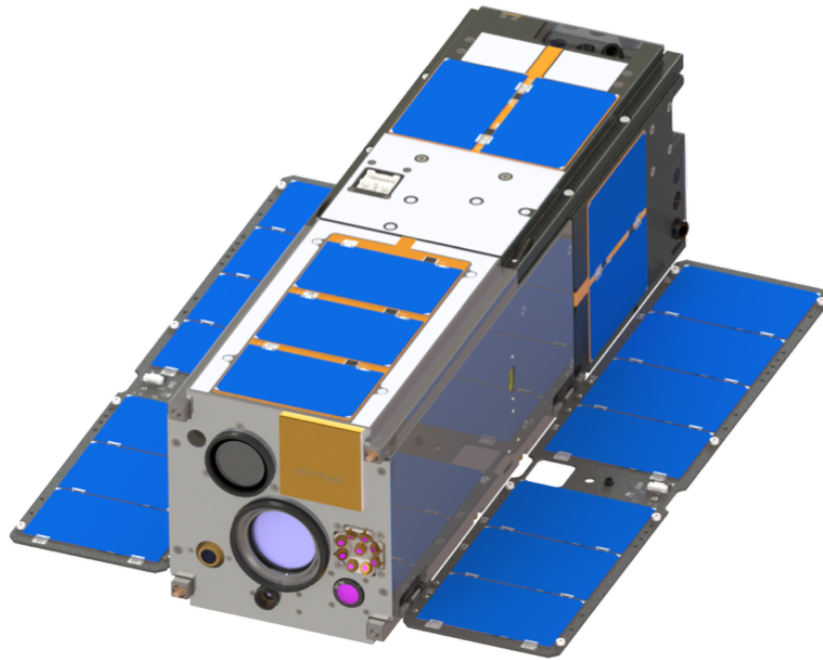

Figure 16: One of two AC11/TOMSat spacecraft with solar panels deployed.

Overview & CONOPS

The AeroCube 11/Testbed for Optical Missions Satellite (AC11/TOMSat) program consists of two nearly-identical spacecraft that will demonstrate the technological capability of two imaging sensors. One satellite will host a pushbroom time delay integration (TDI) sensor that will provide normalized difference vegetation index (NVDI) data for comparison to NVDI provided by Landsat's Operational Land Imager (OLI). The second AC11/TOMSat spacecraft will host an SB-501 focal plane array that will image terrestrial, lunar, and stellar targets. Both satellites will have a laser communication downlink. The goal of AC11/TOMSat is to show that these sensors perform comparably to flagship missions, such as Landsat.

Materials

The AC11/TOMSat spacecraft are 3U CubeSats with outer dimensions of 34 cm x 11 cm x 11 cm. Deployable solar panels extend off the long axis of the spacecraft with dimensions 34 cm x 10 cm. The exterior bus is made from 6061-T6 aluminum and houses all payload and electronics components. The nadir face contains an earth sensor and a sun sensor for attitude determination, a fish-eye camera, laser collimator and uplink receiver, and a radio patch antenna. The zenith face also contains a radio patch antenna as well as two star trackers. The payload for each spacecraft is a custom-made telescope made from aluminum, glass lenses, and titanium spacers and uses about 1.5U of space. A radiator is built into the bus to help the payload maintain proper temperatures. About 1U is dedicated to the avionics block, which houses mission electronics, reaction wheels, batteries, and data storage. These components share flight heritage with previous AeroCube launches. A significant portion of AC11/TOMSat's flight hardware is derived from earlier AeroCube spacecraft already in orbit.

Hazards

There are no pressure vessels, hazardous or exotic materials.

Batteries

Power for the AC11/TOMSat spacecraft is generated by solar cells mounted onto panels that will be deployed from both sides of the bus, as well as cells affixed to the spacecraft bus. These cells are capable of producing up to 23 W of power. Power is stored on-board with lithium-ion batteries. The satellite has 4 batteries mounted in an aluminum 6061-T6 structure as a unit and are shock and thermally isolated by a low-outgassing rubber grommet. Each battery is composed of two cells. Two batteries are rated at 9 W-hr while the other two are rated at 6 W-hr, for a total of 30 W-hr on the spacecraft.

Table 3: TOMSat Battery Specs

Model Number (UL Listing)	Manufacturer	Number of Cells	Energy Stored
ICR18650H	Molicel	2	<=9 W-hr per cell (2 batteries total)
IBR18650BC	Molicel	2	<=6 W-hr per cell (2 batteries total)

The batteries are consumer-oriented devices. The batteries have been recognized as UL tested and approved. UL recognition has been determined through the UL Online Certifications Directory, which clearly shows that these cell batteries have undergone and passed UL Standards. Furthermore, safety devices incorporated in these batteries include pressure release valves, over-current charge protection, and over-current discharge protection.

SHFT-1 – DARPA / STO - 3U

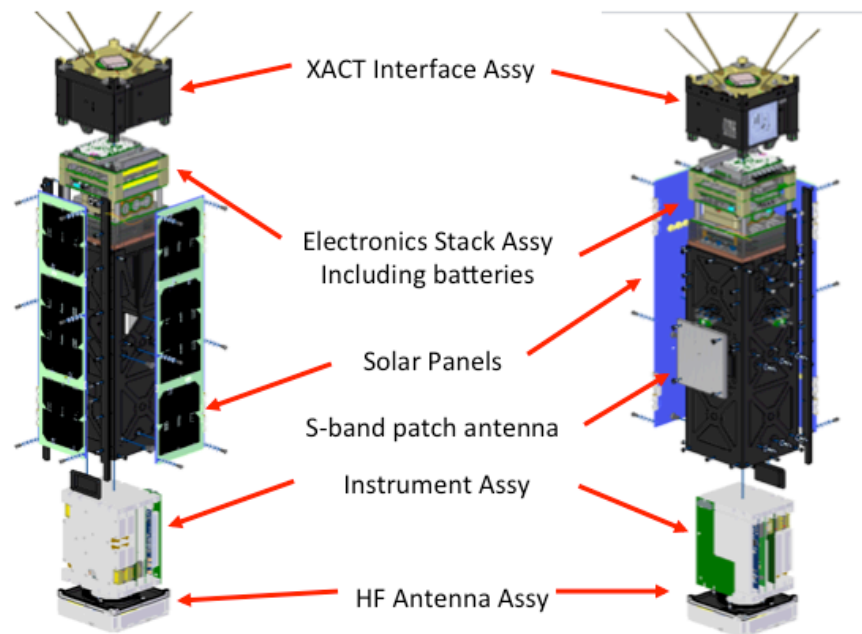

Figure 17: SHFT 3U Cube-sat Expanded View

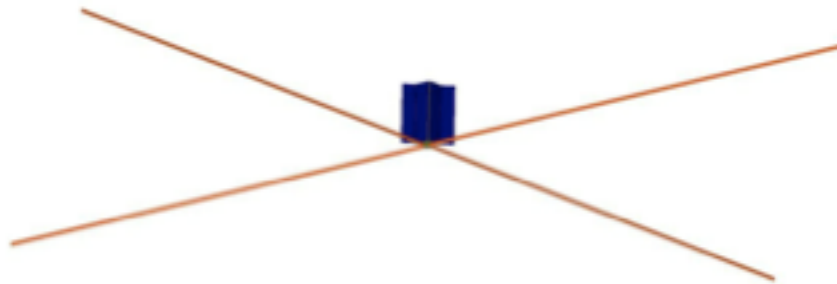

Figure 18: SHFT 3U Cube-sat Deployed view with 3 meter HF antennas

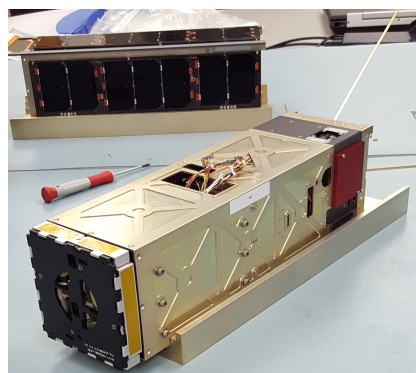

Figure 19: SHFT 3U Cube-sat Stowed configuration

Overview

The SHFT mission will collect radio frequency signals in the HF (5-30 MHz) band to study the galactic background emissions, the HF signals from Jupiter, and the signals from terrestrial transmitters after having passed through the earth's ionosphere. The ionosphere changes its characteristics on a minute to minute basis, particularly changing between day and night, but also in response to geomagnetic phenomena and solar events.

CONOPS

After deployment from the PSC CSD, the SHFT Cubesat will power up, deploy the solar panels and UHF telecom antennas, establish positive power state and wait for ground communications. Upon ground command, the HF antenna (4 tape measure type antenna, each 3 meters long) will be deployed. Over the next 3 months, the spacecraft will periodically record signals in the 5-30 MHz band for 10 minutes, then will transmit the recorded signals to the ground station on subsequent passes for analysis.

Materials

The primary CubeSat structure is made of Aluminum. It contains all standard commercial off the shelf (COTS) materials, electrical components, PCBs and solar cells. The deployable 3 meter HF antenna elements are made of cold rolled steel (i.e. they are standard construction tape measures).

Hazards

There are no pressure vessels, hazardous or exotic materials.

Batteries

The electrical power storage system consists of common Lithium ion batteries with over-charge/current protection circuitry in the spacecraft power controller.

ALBus – NASA Glenn Space Flight Center – 3U CubeSat

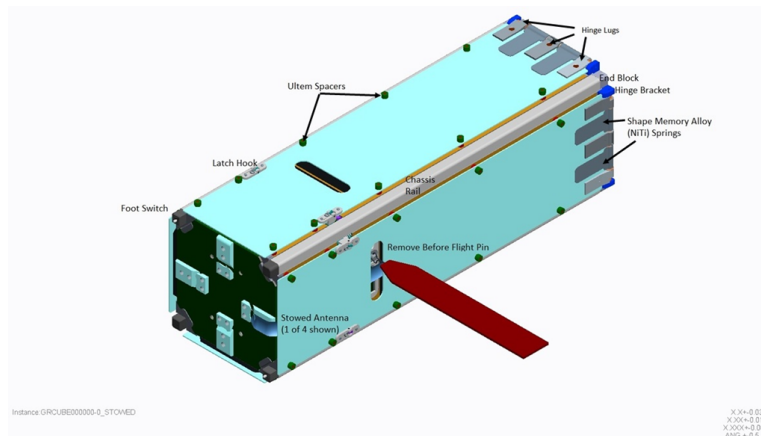

Figure 20: ALBus Stowed View

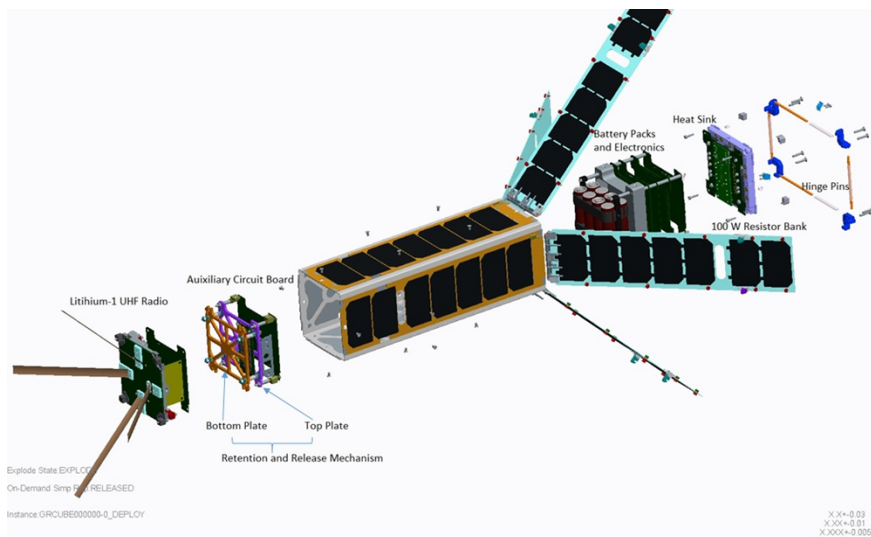

Figure 21: ALBus Expanded/Deployed View

Overview

The Advanced Electrical Bus (ALBus) mission is a pathfinder engineering demonstration of a high power 3-U CubeSat. The primary objectives include demonstration of 100 W power distribution in the 3-U form factor and functional demonstration of shape memory alloy retention and release mechanisms for solar array deployment and power transfer.

CONOPS

Upon deployment from the CubeSat deployer, the ALBus CubeSat will power up and hold for the duration prescribed by the launch provider. Following the prescribed hold, ALBus will attempt deployment of the deployable solar arrays and antennas utilizing the shape memory alloy retention and release mechanism. Following these deployments, the CubeSat will begin beaming in an attempt to establish communication with the ground network. Once communication is established, the ALBus will undergo a series of automated checkouts prior to moving into a stand-by mode. A series of permissives will

be checked on-board and the system will schedule its first test to demonstrate the key objective, which is delivery of 100 W of electrical power to a passive load bank. The 100 W demonstration will run until prescribed temperature limits are reached on control thermocouple or another system shutdown parameter is activated. A series of tests will follow varying length, duration, system initial conditions and environmental conditions to characterize the performance of the system.

Materials

The primary CubeSat structure is made of Aluminum. It contains standard commercial off the shelf (COTS) materials, electrical components, PCBs and solar cells. The retention and release mechanism and hinge assembly for the deployable solar arrays are designed and built in house and primarily consist of off the shelf materials. The shape memory alloys used for actuation of the solar array deployment are a customized alloy of Nickel-Titanium, made at NASA GRC.

Hazards

There are no pressure vessels, hazardous or exotic materials.

Batteries

The electrical power storage system consists of common COTS Li-Ion batteries from GOM Space with over-charge/current protection circuitry.

Section 3: Assessment of Spacecraft Debris Released during Normal Operations

The assessment of spacecraft debris requires the identification of any object (>1 mm) expected to be released from the spacecraft any time after launch, including object dimensions, mass, and material.

The section 3 requires rationale/necessity for release of each object, time of release of each object, relative to launch time, release velocity of each object with respect to spacecraft, expected orbital parameters (apogee, perigee, and inclination) of each object after release, calculated orbital lifetime of each object, including time spent in Low Earth Orbit (LEO), and an assessment of spacecraft compliance with Requirements 4.3-1 and 4.3-2.

No releases are planned on the ELaNa-19 CubeSat mission therefore this section is not applicable.

Section 4: Assessment of Spacecraft Intentional Breakups and Potential for Explosions.

There are NO plans for designed spacecraft breakups, explosions, or intentional collisions on the ELaNa-19 mission.

The probability of battery explosion is very low, and, due to the very small mass of the satellites and their short orbital lifetimes the effect of an explosion on the far-term LEO environment is negligible (ref (h)).

The CubeSats batteries still meet Req. 56450 (4.4-2) by virtue of the HQ OSMA policy regarding CubeSat battery disconnect stating;

“CubeSats as a satellite class need not disconnect their batteries if flown in LEO with orbital lifetimes less than 25 years.” (ref. (h))

ELaNa-19 manifest one, 6U CubeSats which are not included in the 3U or smaller mentioned in ref. (h). However, this CubeSat has protective circuitry in their designs and COTS components.

ANDESITE’s EPS and battery system has over-current poly switch protection, over-current bus protection, and battery under-voltage protection built into the EPS system. The ANDESITE CubeSat use UL listed battery cells.

Limitations in space and mass prevent the inclusion of the necessary resources to disconnect the battery or the solar arrays at EOM. However, the low charges and small battery cells on the CubeSat’s power system prevents a catastrophic failure, so that passivation at EOM is not necessary to prevent an explosion or deflagration large enough to release orbital debris.

Assessment of spacecraft compliance with Requirements 4.4-1 through 4.4-4 shows that with a maximum cubesat lifetime of 6.2 years maximum the ELaNa-19 CubeSat is compliant.

Section 5: Assessment of Spacecraft Potential for On-Orbit Collisions

Calculation of spacecraft probability of collision with space objects larger than 10 cm in diameter during the orbital lifetime of the spacecraft takes into account both the mean cross sectional area and orbital lifetime.

The largest mean cross sectional area (CSA) among the fourteen CubeSats is that of the CubeSail CubeSat with solar sail / tether deployed (250m X 0.08m solar sail):

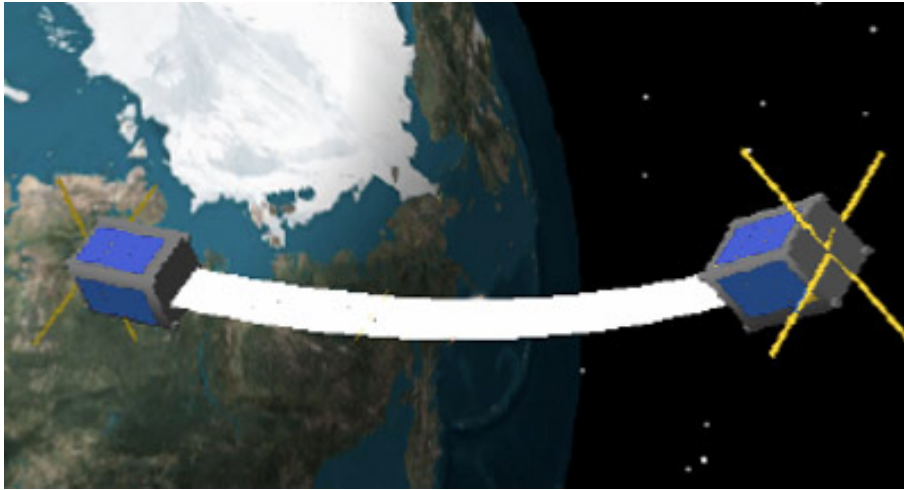

Figure 22: CubeSail Deployed Config

$$\text{Mean CSA} = \frac{\sum \text{Surface Area}}{4} = \frac{[2 * (w * l) + 4 * (w * h)]}{4}$$

Equation 1: Mean Cross Sectional Area for Convex Objects

$$\text{Mean CSA} = \frac{(A_{max} + A_1 + A_1)}{2}$$

Equation 2: Mean Cross Sectional Area for Complex Objects

All CubeSats evaluated for this ODAR are stowed in a convex configuration, indicating there are no elements of the CubeSats obscuring another element of the same CubeSats from view. Thus, mean CSA for all stowed CubeSats was calculated using Equation 1. This configuration renders the longest orbital life times for all CubeSats.

Once a CubeSat has been ejected from the P-POD and deployables have been extended Equation 2 is utilized to determine the mean CSA. A_{max} is identified as the view that yields the maximum cross-sectional area. A_1 and A_2 are the two cross-sectional areas orthogonal to A_{max} . Refer to Appendix D for component dimensions used in these calculations

The CubeSail (3.52 kg) orbit at deployment is 500km apogee altitude by 500 km perigee altitude, with an inclination of 85 degrees. With an area to mass ratio of 2.853 m²/kg, DAS yields < 0.1 years for orbit lifetime for its deployed state, which in turn is used to obtain the collision probability. Even with the variation in CubeSat design and orbital

lifetime ELaNa-19 CubeSats see an average of 0.00000 probability of collision. All CubeSats on ELaNa-19 were calculated to have a probability of collision of 0.00000. Table 4 below provides complete results.

There will be no post-mission disposal operation. As such the identification of all systems and components required to accomplish post-mission disposal operation, including passivation and maneuvering, is not applicable.

Table 4: CubeSat Orbital Lifetime & Collision Probability

CubeSat	Component Mass (kg)	Stowed				Deployed			
		Mean C/S Area (m ²)	Area-to Mass (m ² /kg)	Orbital Lifetime (yrs)	Probability of collision (10 ^{^X})	Mean C/S Area (m ²)	Area-to Mass (m ² /kg)	Orbital Lifetime (yrs)	Probability of collision (10 ^{^X})
ANDESITE	10.36	0.076	0.007	5.3	0.00000	0.108	0.016	4.1	0.00000
ANDESITE - Node	0.452	-	-	-	-	0.012	0.025	3.7	0.00000
CeREs	4.50	0.039	0.009	5.0	0.00000	0.074	0.016	4.1	0.00000
CHOMPTT	3.59	0.039	0.011	4.6	0.00000	0.041	0.012	4.5	0.00000
CubeSail	3.52	0.036	0.010	4.7	0.00000	10.036	2.851	<0.1	0.00000
DaVinci	3.38	0.046	0.014	4.3	0.00000	0.101	0.030	3.5	0.00000
ISX	3.50	0.044	0.013	4.4	0.00000	0.045	0.013	4.4	0.00000
NMTSat	2.50	0.042	0.017	4.1	0.00000	0.049	0.020	3.9	0.00000
Rsat	3.07	0.045	0.015	4.2	0.00000	0.063	0.020	3.9	0.00000
Shields-1	6.93	0.042	0.006	5.9	0.00000	0.049	0.007	5.5	0.00000
STF-1	3.01	0.047	0.016	4.1	0.00000	0.049	0.016	4.1	0.00000
TOMSat EAGLESCOUT	5.03	0.041	0.008	5.1	0.00000	0.063	0.013	4.4	0.00000
TOMSat R3	4.66	0.041	0.009	5.0	0.00000	0.063	0.014	4.3	0.00000
SHFT-1	5.10	0.048	0.009	4.9	0.00000	0.186	0.036	4.1	0.00000
ALBus	2.91	0.046	0.016	4.1	0.00000	0.102	0.035	3.4	0.00000

Solar Flux Table Dated 11/07/2016

The probability of any ELaNa-19 spacecraft collision with debris and meteoroids greater than 10 cm in diameter and capable of preventing post-mission disposal is less than 0.00000, for any configuration. This satisfies the 0.001 maximum probability requirement 4.5-1.

Since the CubeSats have no capability or plan for end-of-mission disposal, requirement 4.5-2 is not applicable.

Assessment of spacecraft compliance with Requirements 4.5-1 shows ELaNa-19 to be compliant. Requirement 4.5-2 is not applicable to this mission.

Section 6: Assessment of Spacecraft Postmission Disposal Plans and Procedures

All ELaNa-19 spacecraft will naturally decay from orbit within 25 years after end of the mission, satisfying requirement 4.6-1a detailing the spacecraft disposal option.

Planning for spacecraft maneuvers to accomplish postmission disposal is not applicable. Disposal is achieved via passive atmospheric reentry.

Calculating the area-to-mass ratio for the worst-case (smallest Area-to-Mass) post-mission disposal among the CubeSats finds Shields-1 in its stowed configuration as the worst case. The area-to-mass is calculated for is as follows:

$$\frac{\text{Mean } C/S \text{ Area (m}^2\text{)}}{\text{Mass (kg)}} = \text{Area - to - Mass } \left(\frac{\text{m}^2}{\text{kg}}\right)$$

Equation 3: Area to Mass

$$\frac{0.0417\text{m}^2}{6.94\text{kg}} = 0.0060 \frac{\text{m}^2}{\text{kg}}$$

Shields-1 has the smallest Area-to-Mass ratio and as a result will have the longest orbital lifetime. The assessment of the spacecraft illustrates they are compliant with Requirements 4.6-1 through 4.6-5.

DAS 2.0.2 Orbital Lifetime Calculations:

DAS inputs are: 500 km maximum apogee 500 km maximum perigee altitudes with an inclination of 85 degrees at deployment no earlier than March 1, 2018. An area to mass ratio of 0.0060 m²/kg for the Shields-1 CubeSat was imputed. DAS 2.1.1 yields a 5.9 years orbit lifetime for Shields-1 in its stowed state.

This meets requirement 4.6-1. For the complete list of CubeSat orbital lifetimes reference Table 4: CubeSat Orbital Lifetime & Collision Probability.

Assessment results show compliance.

Section 7: Assessment of Spacecraft Reentry Hazards

A detailed assessment of the components to be flown on ELaNa-19 was performed. The assessment used DAS 2.1.1, a conservative tool used by the NASA Orbital Debris Office to verify Requirement 4.7-1. The analysis is intended to provide a bounding analysis for characterizing the survivability of a CubeSat’s component during re-entry. For example, when DAS shows a component surviving reentry it is not taking into account the material ablating away or charring due to oxidative heating. Both physical effects are experienced upon reentry and will decrease the mass and size of the real-life components as the reenter the atmosphere, reducing the risk they pose still further.

The following steps are used to identify and evaluate a components potential reentry risk relative to the 4.7-1 requirement of having less than 15 J of kinetic energy and a 1:10,000 probability of a human casualty in the event the survive reentry.

1. Low melting temperature (less than 1000 °C) components are identified as materials that would never survive reentry and pose no risk to human casualty. This is confirmed through DAS analysis that showed materials with melting temperatures equal to or below that of copper (1080 °C) will always demise upon reentry for any size component up to the dimensions of a 1U CubeSat.
2. The remaining high temperature materials are shown to pose negligible risk to human casualty through a bounding DAS analysis of the highest temperature components, stainless steel (1500°C). If a component is of similar dimensions and has a melting temperature between 1000 °C and 1500°C, it can be expected to possess the same negligible risk as stainless steel components. See Table 5 through Table 7.

Table 5: ELaNa-19 High Melting Temperature Material Analysis (1/3)

CubeSat	High Temp Component	Material	Mass (g)	Demise Alt (km)	KE (J)
ANDESITE	Node Deployment Springs	Steel AISI 304	0.002	76.4	0
ANDESITE	Antennae	Steel AISI 410	0.001	0	0
ANDESITE	6-32 Screws	Stainless Steel (generic)	0.000	77.5	0
ANDESITE	2-56 Screws	Stainless Steel (generic)	0.000	77.4	0
ANDESITE	Hinges	Stainless Steel (generic)	0.006	0	1
CeREs	Tungsten Tube	Tungsten	0.202	0	150
CeREs	Detector	Silicon	0.008	0	0
CeREs	Closeout Plate 1	Tungsten	0.018	0	8
CHOMPPT	StenSat UHF Antennae	Stainless Steel (generic)	0.001	0	0
CHOMPPT	Lithium UHF Antennae	Stainless Steel (generic)	0.001	0	0
CHOMPPT	Backplane Holder - 11 mm	Steel AISI 304	0.002	0	0
CHOMPPT	Backplane Holder - 13 mm	Steel AISI 304	0.002	0	0
CHOMPPT	Reaction Wheel Assembly	Stainless Steel (generic)	0.096	68.6	0

Table 6: ELaNa-19 High Melting Temperature Material Analysis (2/3)

CubeSat	High Temp Component	Material	Mass (g)	Demise Alt (km)	KE (J)
CHOMPTT	Batteries	Stainless Steel (generic)	0.045	69	0
CHOMPTT	Battery Holder Plates 2a&2b*	Steel AISI 304	0.058	0	6
CHOMPTT	Lithium Radio	Stainless Steel (generic)	0.026	0	6
CHOMPTT	Retoreflector Array	Stainless Steel (generic)	0.018	0	4
CubeSail	CubeSail Antenna	Stainless Steel (generic)	4.400	74.7	0
CubeSail	Fasteners	Stainless Steel (generic)	100.000	77.7	0
CubeSail	Low-head Socket Cap Screw	Stainless Steel (generic)	0.680	77	0
CubeSail	Wave Spring	Steel AISI 304	0.045	77.9	0
CubeSail	SRU Nut Plate	Stainless Steel (generic)	7.530	75.3	0
CubeSail	Wave Spring 2	Steel AISI 304	0.045	77.8	0
CubeSail	Motor Pin	Steel A-286	0.091	77.6	0
CubeSail	Socket Cap Screw	Stainless Steel (generic)	0.454	77.3	0
CubeSail	Socket Cap Screw 2	Stainless Steel (generic)	0.771	77.1	0
CubeSail	Bobbin Motor Bearing	Stainless Steel (generic)	1.000	76.7	0
CubeSail	Drive Pin	Steel A-286	0.272	77.2	0
CubeSail	Socket Cap Screw 3	Stainless Steel (generic)	0.635	77.3	0
ISX	Historesis Material	Stainless Steel (generic)	0.0015	77	0
ISX	Screw - Representative	Stainless Steel (generic)	0.00045	76.9	0
ISX	Structural Rods	Stainless Steel (generic)	0.001	77.4	0
ISX	ISIS screws	Stainless Steel (generic)	0.00025	77.1	0
ISX	ISIS washers	Stainless Steel (generic)	0.00005	0	0
ISX	GAMMA Antenna washers	Stainless Steel (generic)	0.00005	0	0
ISX	GAMMA Antenna screws	Stainless Steel (generic)	0.0006	76.2	0
ISX	GAMMA Antenna nuts	Stainless Steel (generic)	0.00001	0	0
ISX	solar panel screw	Stainless Steel (generic)	0.00054	76.6	0
ISX	solar panel nut	Stainless Steel (generic)	0.000241	0	0
ISX	Solar panel clip	Stainless Steel (generic)	0.0005	0	0
ISX	15mm spacers	Stainless Steel (generic)	0.002	75	0
ISX	25mm spacers	Stainless Steel (generic)	0.005	73.5	0
Rsat	Motors	Stainless Steel (generic)	0.01933	73.3	0
Rsat	ADCS	Stainless Steel (generic)	0.01	0	3
Rsat	Fasteners	Stainless Steel (generic)	0.00005	77.6	0
Shields-1	Shield1	Tantalum	0.2	0	69
Shields-1	Shield2	Titanium (6 Al-4 V)	0.072364523	0	14
Shields-1	Shield3	Tantalum	0.1	0	27
Shields-1	Shield4	Titanium (6 Al-4 V)	0.00001	0	0
Shields-1	Shield5	Tantalum	0.00001	0	0
Shields-1	Shield6	Titanium (6 Al-4 V)	0.0001	0	0
Shields-1	Shield7	Titanium (6 Al-4 V)	0.0001	0	0

Battery Holder Plates 2a&2b*Has been updated with corrected “per unit mass” of 0.058kg resulting in 6J of energy for surviving component

Table 7: ELaNa-19 Summary of Surviving High Temperature Material Components (3/3)

CubeSat	High Temp Component	Material	Mass (g)	Demise Alt (km)	KE (J)
Shields-1	Shield8	Titanium (6 Al-4 V)	0.0001	0	0
Shields-1	Charge Dissipation Film electrodes	Steel AISI 304	0.01	73.8	0
Shields-1	Charge Dissipation Film spring	Stainless Steel (generic)	0.0025	76.1	0
Shields-1	RTDs (Est Dims)	Stainless Steel (generic)	0.001	77.5	0
Shields-1	Fasteners2	Stainless Steel (generic)	0.0001	77.7	0
Shields-1	Fasteners3	Stainless Steel (generic)	0.00005	77.7	0
Shields-1	Fasteners4	Stainless Steel (generic)	0.0005171	0	0
Shields-1	Solar Panel Screws	Steel AISI 410	0.00008	77.6	0
Shields-1	Solar Panel Washers	Steel AISI 410	0.0001	0	0
Shields-1	Remove Before Flight Pin	Stainless Steel (generic)	0.02	73.7	0
Shields-1	Sep Switch	Stainless Steel (generic)	0.02	73.7	0
Shields-1	ADCS Components (Hysteresis Rods)	Stainless Steel (generic)	0.001	77.5	0
STF-1	Ferrite Bead	Stainless Steel (generic)	0.00001	77.3	0
STF-1	Geiger Tube	Stainless Steel (generic)	0.05	67	0
STF-1	Fasteners5	Stainless Steel (generic)	0.00001	77.9	0
TOMSat	Reaction Wheels	Stainless Steel (generic)	0.22501	63.9	0
TOMSat	Single Torque Rod	Stainless Steel (generic)	0.01844	74.8	0
TOMSat	18267	Titanium (generic)	0.01669	0	2
TOMSat	18265	Titanium (generic)	0.01092	0	1
TOMSat	18264	Titanium (generic)	0.01232	0	1
TOMSat	18268	Titanium (generic)	0.00404	0	0
TOMSat	18266	Titanium (generic)	0.01028	0	2
TOMSat	18263	Titanium (generic)	0.00128	0	0
TOMSat	18270	Titanium (generic)	0.00074	0	0
TOMSat	Laser	Aluminum 6061-T6	0.35285	72.8	0
SHFT-1	Internal Fasteners	Stainless Steel (generic)	0.0005	77	0
SHFT-1	External Fasteners	Stainless Steel (generic)	0.0005	77	0
ALBus	Threaded Rod	Stainless Steel (generic)	.00068	78	0
ALBus	Baseplate	Aluminum 7075-T6	0.0008	78	0
ALBus	Springs	Titanium (generic)	0.0069	78	0
ALBus	Gravity mass	Stainless Steel (generic)	0.0009	78	0
ALBus	Screws	Steel AISI 304	0.0004	78	0
ALBus	Spacers	Steel AISI 304	0.0058	78	0
ALBus	Battery pack	Aluminum 7075-T6	0.0228	78	0
DaVinci	Reaction Wheel Daughter Board	Stainless Steel (generic)	0.1	0	14

The majority of high temperature components demise upon reentry. And all CubeSats comply with the 1:10,000 probability of Human Casualty Requirement 4.7-1. A breakdown of the determined probabilities follows on Table 7.

Table 8: Requirement 4.7-1 Compliance by CubeSat

CubeSat	Risk	Risk < 1:10,000
ANDESITE	1:0	Compliant
CeREs	1:210,600	Compliant
CHOMPTT	1:93,400	Compliant
CubeSail	1:0	Compliant
ISX	1:0	Compliant
NMTsat	1:0	Compliant
Rsat	1:0	Compliant
Shields-1	1:32,400	Compliant
STF-1	1:0	Compliant
TOMSat	1:0	Compliant
SHFT-1	1:0	Compliant
ALBus	1:0	Compliant
DaVinci	1:0	Compliant

*Requirement 4.7-1 Probability of Human Casualty > 1:10,000

If a component survives to the ground but has less than 15 Joules of kinetic energy it is not included in the Debris Casualty Area that inputs into the Probability of Human Casualty calculation. Which is why CubeSats that have surviving components like ANDESITE, CubeSail, DaVinci, ISX, NMTsat, CHOMPTT, Rsat, STF-1 TOMSat EAGLESCOUT, TOMSat R3, SHFT-1, and ALBus have a 1:0 probability as none of their components have more than 15J of energy. The breakdown of CubeSat’s with greater than 15J of energy components is as follows: CeREs has 1 and Shields-1 has 3. These two CubeSats are well within the NASA requirements for uncontrolled reentry.

All CubeSats launching under the ELaNa-19 mission are shown to be in compliance with Requirement 4.7-1 of NASA-STD-8719.14A.

See the Appendix for a complete accounting of the survivability of all CubeSat components.

Section 8: Assessment for Tether Missions

In the ELaNa-19 mission, CubeSail's deployable sail made of a mylar film qualifies as a momentum tether although a ribbon would be a more accurate description of its dimensions (0.0004 cm x 7.9cm x 25,317 cm).

The tether mission plan can be referenced in the CubeSail specific mission plan located in Section 2. (See Page 16 for the CONOPs)

Following the Methods to Assess Compliance for Tethered Systems (section 4.8.4), the DAS analysis determined the CubeSail design to be COMPLIANT with both Requirement 4.5-1 and 4.5-2 dealing with meeting the requirements limiting the generation or orbital debris from on-orbit collisions. The probability of collision on orbit for the un-deployed system, fully deployed system, and ½ the system in the event of a tether severing event was calculated to be $\ll 0.001$.

CubeSail is also compliant with Requirements 4.6-1 to 4.6-4 (Postmission Disposal), given the low 500km x 500km, this orbit will have CubeSail passively deorbit in 5.5 years if the system does not deploy, $\ll 0.1$ years if the system does deploy, and $\ll 0.1$ year if the tether breaks into two equal parts as calculated via DAS 2.0.2. All three scenarios are compliant with the Requirement 4.6-1 to 4.6-4.

	Tether	Requirement 4.5-1	Requirement 4.5-2	Requirement 4.6	Orbital Decay
Row	State	Compliance Status	Compliance Status	Compliance Status	(days)
1	momentum	Compliant	Compliant	Compliant	12.0

Figure 23: Tether Assessment of CubeSail

ELaNa-19 CubeSat, CubeSail satisfies Section 8's requirement 4.8-1.

Section 9-14

ODAR sections 9 through 14 for the launch vehicle are not covered here.

If you have any questions, please contact the undersigned at 321-867-2958.

/original signed by/

Justin Treptow
Flight Design Analyst
NASA/KSC/VA-H1

cc: VA-H/Mr. Carney
VA-H1/Mr. Beaver
VA-H1/Mr. Haddox
VA-G2/Mr. Atkinson
VA-G2/Mr. Marin
SA-D2/Mr. Frattin
SA-D2/Mr. Hale
SA-D2/Mr. Henry
Analex-3/Mr. Davis
Analex-22/Ms. Ramos

Appendix Index:

Appendix A.	ELaNa-19 Component List by CubeSat: ANDESITE
Appendix B.	ELaNa-19 Component List by CubeSat: CeREs
Appendix C.	ELaNa-19 Component List by CubeSat: CHOMPTT
Appendix D.	ELaNa-19 Component List by CubeSat: CubeSail
Appendix E.	ELaNa-19 Component List by CubeSat: DaVinci
Appendix F.	ELaNa-19 Component List by CubeSat: ISX
Appendix G.	ELaNa-19 Component List by CubeSat: NMTSat
Appendix H.	ELaNa-19 Component List by CubeSat: RSat
Appendix I.	ELaNa-19 Component List by CubeSat: Shields-1
Appendix J.	ELaNa-19 Component List by CubeSat: STF-1
Appendix K.	ELaNa-19 Component List by CubeSat: TOMSat EAGLESCOUT
Appendix L.	ELaNa-19 Component List by CubeSat: TOMSat R3:
Appendix M.	ELaNa-19 Component List by CubeSat: SHFT-1
Appendix N.	ELaNa-19 Component List by CubeSat: ALBus

Appendix A. ELaN-19 Component List by CubeSat: ANDESITE

CUBESAT	Row Number	Name	Qty	Material	Body Type	Individual Mass (g)	Diameter/Width (mm)	Length (mm)	Height (mm)	High Temp	Melting Temp	Survivability
ANDESITE	1	6U Anodized Baseplate	1	Aluminum 7075	Flate Plate	1346	239	361	6.35	No	-	Demise
ANDESITE	2	Sensor Node Structure	8	Alumnium 6061	Box	133	97.81	190	15.5	No	-	Demise
ANDESITE	3	Top Plate	1	Aluminum 6061	Box	364	227.8	361	3.18	No	-	Demise
ANDESITE	4	CubeSat Structure - 2U L Brackets	2	Aluminum 6061	Box	60	19.05	223.23	3.18	No	-	Demise
ANDESITE	5	CubeSat Structure - 1U L Brackets	4	Aluminum 6061	Box	36	19.05	93.65	3.18	No	-	Demise
ANDESITE	6	CubeSat Structure - 1U Cladding	2	Aluminum 6061	Box	38	227.8	100	2.29	No	-	Demise
ANDESITE	7	CubeSat Structure - 2U Cladding	2	Aluminum 6061	Box	110	148.6	100	2.29	No	-	Demise
ANDESITE	8	Top Solar Panel	1	Fiberglass	Cylinder	150	227.8	361		No	-	Demise
ANDESITE	9	Wing Solar Panel	2	Fiberglass	Box	98	354.86	86	3.18	No	-	Demise
ANDESITE	10	Node Deployment Mechanism	1	Aluminum 6061	Flat Plate	1549	210	151.33	15	No	-	Demise
ANDESITE	11	Node Deployment Peg Guides	4	Aluminum 6061	Box	82	27.6	100	15	No	-	Demise
ANDESITE	12	Node Deployment Springs	8	Steel 302	Cylinder	4.4	4.7752		19.05	Yes	1538	See Tables 4-6
ANDESITE	13	Antennae	9	Steel 410	Blade	0.8	12.7	165.1	1	Yes	1532	See Tables 4-6
ANDESITE	14	Sensor Node Solar Panels	16	Fiberglass	PCB	67.3	175	93.73	2	No	-	Demise
ANDESITE	15	Mule Battery	1	Battery	Box	260.4	95	90	39.82	No	-	Demise
ANDESITE	16	Node Batteries	8	Battery	Box	184.4	59.5	157	9.8	No	-	Demise
ANDESITE	17	EPS	1	Fiberglass (PCB)	Board	174	96	90	1.5	No	-	Demise
ANDESITE	18	ADCS Components (eg. Magnets)	1	Fiberglass (PCB)	Board	94.2	96	90	1.5	No	-	Demise
ANDESITE	19	Comm Board	1	Fiberglass (PCB)	Board	125	96	90	1.5	No	-	Demise
ANDESITE	20	C&DH Board	1	Fiberglass (PCB)	Board	142	96	90	1.5	No	-	Demise
ANDESITE	21	Magnetometer Orthogonal Holder	1	Macor	Holder	5	5	5	5	No	-	Demise
ANDESITE	22	Magnetorquers	1	Copper	Board/Coils	95.9	96	90	1.5	No	-	Demise
ANDESITE	23	6-32 Screws	90	Stainless Steel 316	Screws	0.5	3.5052		6.35	Yes	1400	See Tables 4-6
ANDESITE	24	2-56 Screws	150	Stainless Steel 316	Screws	0.3	2.1844		6.35	Yes	1400	See Tables 4-6
ANDESITE	25	Bumpers	4	Nylon	Blocks	2	25.4	50.8	2.54	No	-	Demise
ANDESITE	26	Hinges	4	Stainless Steel 316	Hinge	12	25.4	50.8	0.889	Yes		See Tables 4-6

Appendix B. ELaNa-19 Component List by CubeSat: CeREs

CUBESAT	Row Number	Name	Qty	Material	Body Type	Individual Mass (g)	Diameter/Width (mm)	Length (mm)	Height (mm)	High Temp	Melting Temp	Survivability
Ceres	1	Cubesat Structure	1	Aluminium 6061-T6	Box	700	100	100	340	No	-	Demise
Ceres	2	Payload Structure	1	Aluminium 6061-T6	Box	250	74	52	94	No	-	Demise
Ceres	3	Tungsten Tube	1	Tungsten	Cylinder	202	67	40		Yes	3422	See Tables 4-6
Ceres	4	XB1	1	Aluminum	Box	1800	100	100	135	No	-	Demise
Ceres	5	solar array	2	FR4+Aluminum	Flat Plate	194	65	82	327	No	-	Demise
Ceres	6	Detector	8	Silicon	Cylinder	8	39	39		Yes	1410	See Tables 4-6
Ceres	7	Closeout Plate 1	2	Tungsten	Flat Plate	25	50	14	2	Yes	3422	See Tables 4-6
Ceres	8	Aluminum Closeout Plate Holder	1	Aluminum	Box	20	26	67	17.2	No	-	Demise
Ceres	9	Detector Holder	16	FR4	Flat Plate	5	52	52		No	-	Demise
Ceres	10	Payload Card	4	FR4+Copper	Flat Plate	100	88	92	18	No	-	Demise
Ceres	11	backplane	1	FR4+Copper	Flat Plate	21	7.5	25.4	11.3	No	-	Demise
Ceres	12	HVPS	2	Urethane?	Box	20	33	40.6	12.1	No	-	Demise
Ceres	13	GPS antenna	1	Aluminum 6061-T6	Flat Plate	50	53	18		No	-	Demise
Ceres	14	ISIS antenna	4	Aluminum 6061-T6	Flat Plate	100	98	98	5.7	No	-	Demise
Ceres	15	CSP	1	FR4+Copper	Flat Plate	44	100	100	14.6	No	-	Demise
Ceres	16	Cabling	6	copper alloy	cylinder	8	2	6		No	-	Demise

Appendix C. ELaNa-19 Component List by CubeSat: CHOMP TT (1/2)

CUBESAT	Row Number	Name	Qty	Material	Body Type	Individual Mass (g)	Diameter/Width (mm)	Length (mm)	Height (mm)	High Temp	Melting Temp	Survivability
CHOMP TT	1	3U CubeSat Chassis	1	Aluminum 5052	Box	317	100	100	339.89	No	-	Demise
CHOMP TT	2	StenSat UHF Antennae	1	Stainless Steel (generic)	Box	1.43	12.2	186.5	0.1	Yes	1510	See Tables 4-6
CHOMP TT	3	Lithium UHF Antennae	1	Stainless Steel (generic)	Box	1.43	12.2	195.6	0.1	Yes	1510	See Tables 4-6
CHOMP TT	4	RBF Switch	1	Polycarbonate (aka Lexan)	Box	1.15	12.27	19.84	6.39	No	-	Demise
CHOMP TT	5	Rail Switches	1	Polycarbonate (aka Lexan)	Box	1	13	15	10	No	-	Demise
CHOMP TT	6	GPS Patch Antennae	1	Fiberglass	Flat Plate	9.2	34.94	89.5	-	No	-	Demise
CHOMP TT	7	Sun Sensors	5	Aluminum 6061	Box	4	27.4	14	5.9	No	-	Demise
CHOMP TT	8	1U TASC Solar Panel	5	Aluminum (generic)	Flat Plate	108.18	98.6	98.99	-	No	-	Demise
CHOMP TT	9	1U GOMspace Solar Panel	4	Aluminum (generic)	Flat Plate	57	98	82.6	-	No	-	Demise
CHOMP TT	10	1U GOMspace Solar Panel	4	Aluminum (generic)	Flat Plate	26	98	82.6	-	No	-	Demise
CHOMP TT		EDSN/NODES-derived Spacecraft Bus								-	-	-
CHOMP TT	11	Backplane PCB	1	Fiberglass	Flat Plate	29.759	56.94	140.96	-	No	-	Demise
CHOMP TT	12	Backplane Holder - 11 mm	1	Steel AISI 304	Box	1.52	11	67	0.9	Yes	1538	See Tables 4-6
CHOMP TT	13	Backplane Holder - 13 mm	1	Steel AISI 304	Box	1.99	16	67	0.9	Yes	538	See Tables 4-6
CHOMP TT	14	Midplane	1	Aluminum 6061-T6	Cylinder	3.14	16.9	21.1	-	No	-	Demise
CHOMP TT	15	Router PCB	1	Fiberglass	Flat Plate	44.74	60.63	89.74	-	No	-	Demise
CHOMP TT	16	ACS PCB	1	Fiberglass	Flat Plate	36.94	94.09	95.46	22.77	No	-	Demise
CHOMP TT	17	Reaction Wheel Assembly	1	Stainless Steel (generic)	Box	96.43	26	66	26	Yes	1400	See Tables 4-6
CHOMP TT	18	Phone PCB	1	Fiberglass	Box	51.86	94.09	109.77	30.6	No	-	Demise
CHOMP TT	19	EPS PCB	1	Fiberglass	Box	46.57	94.09	95.46	37.53	No	-	Demise

ELaNa-19 Component List by CubeSat: CHOMP TT (2/2)

CUBESAT	Row Number	Name	Qty	Material	Body Type	Individual Mass (g)	Diameter/Width (mm)	Length (mm)	Height (mm)	High Temp	Melting Temp	Survivability
CHOMP TT	20	Lithium Grounding Hat Assembly	1	Aluminum 6061-T6	Box	1.84	18.13	52.64	5.8	No	-	Demise
CHOMP TT	21	StenSat Grounding Hat Assembly	1	Aluminum 6061-T6	Box	1.32	17	43	5	No	-	Demise
CHOMP TT	22	Batteries	4	Stainless Steel (generic)	Cylinder	45.45	18.3	64.9	-	Yes	1400	See Tables 4-6
CHOMP TT	23	Battery Holder	1	Polycarbonate (aka Lexan)	Box	27.99	78.73	82.6	15.7	No	-	Demise
CHOMP TT	24	Battery Holder Plates 2a&2b	2	Steel AISI 304	Flat Plate	58.5	94.09	95.46	-	Yes	1450	See Tables 4-6
CHOMP TT	25	StenSat Radio Assembly	1	Fiberglass	Box	28.87	44.45	78.74	18.53	No	-	Demise
CHOMP TT	26	GPS PCB	1	Fiberglass	Flat Plate	48.14	94.09	95.5	-	No	-	Demise
CHOMP TT	27	GPS Housing & Heat Sink	1	Aluminum 6061-T6	Flat Plate	32.9	87.01	92.55	-	No	-	Demise
CHOMP TT	28	GPS Reciever	1	Fiberglass	Box	18.3	45.72	71.12	10.19	No	-	Demise
CHOMP TT	29	Lithium Radio PCB	1	Fiberglass	Flat Plate	28.72	94.909	95.46	-	No	-	Demise
CHOMP TT	30	Lithium Radio	1	Stainless Steel (generic)	Box	25.7	32	62	10.079	Yes	1450	See Tables 4-6
CHOMP TT	31	Adapter Plate	-	Aluminum 6061	Flat Plate	40.15	97	97	-	No	-	Demise
CHOMP TT		OPTI Payload								-	-	-
CHOMP TT	32	Payload Structure	1	Aluminum 6061	Box	564.83	96.4	97	94	No	-	Demise
CHOMP TT	33	Supervisor PCB	1	Fiberglass	Box	30.6	86.28	56.12	-	No	-	Demise
CHOMP TT	34	Channel PCB	2	Fiberglass	Flat Plate	30	86.15	86.01	-	No	-	Demise
CHOMP TT	35	High Voltage Shield	2	Aluminum 6061, Cesium	Flat Plate	45.79	84.75	61.75	11.5	No	-	Demise
CHOMP TT	36	CSAC (Chipscale Atomic Clock)	2	Aluminum 6061	Box	35	35.57	40.65	11.43	No	-	Demise
CHOMP TT	37	Beacon Diode PCB	1	Fiberglass	Box	35	12	30.13	-	No	-	Demise
CHOMP TT	38	Retoreflector Array		Fused Silica (Glass)	Box	17.98	52	30	7	Yes	1600	See Tables 4-6
CHOMP TT	39	Fasteners	-	-	-	-	-	-	-	No	-	Demise
CHOMP TT	40	Cabling	-	-	-	-	-	-	-	No	-	Demise
CHOMP TT	41	Large Aperature Plate (-Y)	1	Aluminum 6061	Flat Plate	37	99.78	99.75	-	No	-	Demise

Appendix D. ELaNa-19 Component List by CubeSat: CubeSail (1/3)

CUBESAT	Row Number	Name	Qty	Material	Body Type	Individual Mass (g)	Diameter/Width (mm)	Length (mm)	Height (mm)	High Temp	Melting Temp	Survivability
CubeSail	1	Rail	8	Aluminum 6061	Rail	26.8	17	17	155.75	No	-	Demise
CubeSail	2	Bottom Plate	2	Aluminum 6061	Plate	71.97	100	100	25.5	No	-	Demise
CubeSail	3	Antennae	8	Stainless Steel	Strip	4.4	6.7	22	0.4	Yes	1450	See Tables 4-6
CubeSail	4	Radiation Shielding	6	Aluminum 6061	Plate	35.6	80	161.75	1.016	No	-	Demise
CubeSail	5	Radiation Shielding with Access Port	2	Aluminum 6061	Plate	35.2	80	161.75	1.016	No	-	Demise
CubeSail	6	Solar Cell	22	Solar Cell	Panel	3.2	40	70	0.4	No	-	Demise
CubeSail	7	Flex Cable	8	Kapton and PCB Components	Flat Cable	5	54	18.34	169.32	No	-	Demise
CubeSail	8	Magnetometer	8	Circuit Board	Board	3.7	40	30	3.9	No	-	Demise
CubeSail	9	Daughter Card	2	Circuit Board	Plate	10.1	60	30	2.41	No	-	Demise
CubeSail	10	Power Board	2	Circuit Board	Board	56.5	94	90	1.5	No	-	Demise
CubeSail	11	C&DH Board (was CPU)	2	Circuit Board	Board	40	90	90	5.6002	No	-	Demise
CubeSail	12	Lithium Radio	2	Aluminum 6061 and Circuit Board	Plate	50	60.4	30.4	9	No	-	Demise
CubeSail	13	Radio Carry Board	2	Circuit Board	Board	17.3	70	70	1.6	No	-	Demise
CubeSail	14	Payload Board	2	Circuit Board	Board	30.3	12	90	90	No	-	Demise
CubeSail	15	Connector Adjustment Board	2	Circuit Board	Board	3	5	32	20	No	-	Demise
CubeSail	16	Torque Coil	10	Circuit Board	Board	27.7	90	76.2	3.5	No	-	Demise
CubeSail	17	Middle Plate	2	Aluminum 6061	Plate	66.98	96.83	96.83	13.5	No	-	Demise
CubeSail	18	Battery Pack	2	Lithium Ion Batteries, Circuit Board	4 cylinders, mounted on board	227.2	87	85	22.5	No	-	Demise
CubeSail	19	Battery Holder	2	Aluminum 6061	Board	40	86	86.5	22.8	No	-	Demise
CubeSail	20	Fasteners	1	Stainless Steel	Small	100				Yes	1450	See Tables 4-6

ELaNa-19 Component List by CubeSat: CubeSail (2/3)

CUBESAT	Row Number	Name	Qty	Material	Body Type	Individual Mass (g)	Diameter/ Width (mm)	Length (mm)	Height (mm)	High Temp	Melting Temp	Survivability
CubeSail	21	Cabling	1	Copper alloy, teflon insulation	Wires	150				No	-	Demise
CubeSail	22	Bobbin	2	Al 6061	Cylinder	93.5760296	49.022	84.00034	0	No	-	Demise
CubeSail	23	Motor Mount Plate, Drive Shaft	2	Al 6061	Cylinder	5.3070264	25.4	6.985	0	No	-	Demise
CubeSail	24	Motor Mount Plate, Ribbon Cable	2	Al 6061	Cylinder	6.2142104	25.4	6.985	0	No	-	Demise
CubeSail	25	Motor Support Rod	6	Al 6061	Rod	2.26796	4.7625	50.8	0	No	-	Demise
CubeSail	26	Drive Wheel	2	Al 6061	Cylinder	7.257472	26.9494	8.30834	0	No	-	Demise
CubeSail	27	Shim Rings	4	Al 6061	Ring	0.4989512	26.9494	1.5748	0	No	-	Demise
CubeSail	28	A-Frame, Motor Mount	2	Al 6061	Plate	19.4590968	57.00014	13.4839964	49.9999	No	-	Demise
CubeSail	29	A-Frame, Support	2	Al 6061	Plate	22.8156776	57.00014	13.4919974	49.9999	No	-	Demise
CubeSail	30	Support Rod	4	Al 6061	Rod	36.28736	4.7625	78.3844	0	No	-	Demise
CubeSail	31	Film	2	Aluminized Mylar	Sheet	85	79	253170	0.004	No	-	Demise
CubeSail	32	Low-head Socket Cap Screw	8	18-8 stainless steel	Screw	0.680388	5.7404	8.1788	0	Yes	1450	See Tables 4-6
CubeSail	33	Slit Rod	2	Al 6061 - T6	Rod	2.9937072	6.35	79	0	No	-	Demise
CubeSail	34	Standoff Feet	4	Brass	Screw	0.1360776	3.7084	1.4732	0	No	-	Demise
CubeSail	35	(Motor) Payload Plate, Male	1	Al 6061	Plate	54.43104	16.4999924	99.9998	99.9998	No	-	Demise
CubeSail	36	Camera Mount Dog	1	Al 6061	Block	8.618248	29.972	10.8204	19.9898	No	-	Demise
CubeSail	37	Camera Mount Base	1	Al 6061	Block	8.2553744	19.9898	29.972	7.33298	No	-	Demise
CubeSail	38	Motor Mount Plate	1	Al 6061	Plate	1.9504456	21.2015578	13.9338304	2.54	No	-	Demise
CubeSail	39	Motor Support Rod	4	Al 2024	Rod	1.4061352	3.96875	47.54118	0	No	-	Demise
CubeSail	40	SRU Leadscrew	1	Brass	Screw	3.628736	6.1849	15.986506	0	No	-	Demise

ELaNa-19 Component List by CubeSat: CubeSail (3/3)

CUBESAT	Row Number	Name	Qty	Material	Body Type	Individual Mass (g)	Diameter/ Width (mm)	Length (mm)	Height (mm)	High Temp	Melting Temp	Survivability
CubeSail	41	Compression Spring	2	Zinc-coated Music Wire	Spring	0.226796	7.9193136	18.1991	0	No	-	Demise
CubeSail	42	Motor	2	Brass	Cylinder	75.1	15.93	61.54	0	No	-	Demise
CubeSail	43	Wave Spring	2	302 Stainless Steel	Ring	0.0453592	4.6736	0.5842	0	Yes	1450	See Tables 4-6
CubeSail	44	Slit Rod	2	Al 6061 - T6	Rod	2.9937072	6.35	79	0	No	-	Demise
CubeSail	45	Payload Plate, Female	1	Al 6061	Plate	49.89512	19.2499996	99.9998	99.9998	No	-	Demise
CubeSail	46	Camera Mount Dog	1	Al 6061	Block	8.618248	29.972	10.8204	19.9898			Demise
CubeSail	47	Camera Mount Base	1	Al 6061	Block	8.2553744	19.9898	29.972	7.33298	No	-	Demise
CubeSail	48	SRU Nut Plate	1	Stainless Steel	Plate	7.5296272	26.4922	12.7	3.175	Yes	1430	See Tables 4-6
CubeSail	49	Motor	1	Brass	Cylinder	75.1	15.93	61.54	0	No	-	Demise
CubeSail	50	Wave Spring	2	302 Stainless Steel	Ring	0.0453592	4.6736	0.5842	0	Yes	1450	See Tables 4-6
CubeSail	51	Motor Pin	1	Steel	Cylinder	0.0907184	1.6764	6.1341		Yes	1450	See Tables 4-6
CubeSail	52	Socket Cap Screw	12	18-8 stainless steel	Screw	0.453592	5.4102	7.8486	0	Yes	1450	See Tables 4-6
CubeSail	53	Socket Cap Screw	6	18-8 stainless steel	Screw	0.7711064	4.4958	13.716762	0	Yes	1450	See Tables 4-6
CubeSail	54	SRU Frame Screws	8	Brass	Screw	0.2721552	3.429	9.271	0	No	-	Demise
CubeSail	55	Bobbin Motor Bearing	6	Stainless Steel	Ring	1	3	3	0	Yes	1450	See Tables 4-6
CubeSail	56	Drive Pin	2	Steel	Cylinder	0.2721552	3.175	4.7625	0	Yes	1450	See Tables 4-6
CubeSail	57	LED mount board	4	Circuit Board	Plate	0.5	1.524	36.83	18.415	No	-	Demise
CubeSail	58	3.2x2.4mm LED	6	LED	Block	0	3.1496	2.4384	2.413	No	-	Demise
CubeSail	59	Socket Cap Screw	12	18-8 Stainless Steel	Screw	0.6350288	5.4102	12.6111	0	Yes	1450	See Tables 4-6
CubeSail	60	Slotted Screw	8	Nylon	Screw	0.0907184	5.5626	8.0772	0	No	-	Demise
CubeSail	61	Camera	2	Circuit Board	Block	13.5	20.0000108	28.30068	21.4900002	No	-	Demise

Appendix E. ELaNa-19 Component List by CubeSat: DaVinci

CUBESAT	Row Number	Name	Qty	Material	Body Type	Individual Mass (g)	Diameter/Width (mm)	Length (mm)	Height (mm)	High Temp	Melting Temp	Survivability
DaVinci	1	DaVinci Cubesat	1	Aluminium 6082	Box	-	-	-	-	No	-	Demise
DaVinci	2	CubeSat Structure	1	Aluminium 6082	Box	396	100	100	340.5	No	-	Demise
DaVinci	3	Patch Antenna	1	Ceramic	Disc	69	48.124	48.124	9.652	No	-	Demise
DaVinci	4	Deployable VHF/UHF Antenna	1	Nitinol	Thin strips	12		450	170	No	-	Demise
DaVinci	5	Deployable Solar Panels	2	Copper, Fibreglass, Kapton	Rectangle	332	1.6	200	300	No	-	Demise
DaVinci	6	Solar Panels	2	Copper, Fibreglass, Kapton	Rectangle	142	1.6	100	300	No	-	Demise
DaVinci	7	Duplex Comms Payload	1	PCB	PCB	226	63.73	118.7	26.99	No	-	Demise
DaVinci	8	VUTRX Comms	1	PCB	PCB	96	90.18	95.89	13	No	-	Demise
DaVinci	9	Imaging Payload	1	PCB/Glass	PCB	43	24.4	25	34.1	No	-	Demise
DaVinci	10	Antenna Deployment Module	1	Aluminium	PCB	87	98	98	10.51	No	-	Demise
DaVinci	11	On Board Computer	1	PCB	PCB	73	90.17	95.89	5.51	No	-	Demise
DaVinci	12	Payload Interface Module	1	PCB	PCB	70	90.17	95.89	23.29	No	-	Demise
DaVinci	13	Battery	1	lithium ion polymer	PCB	331	90.17	95.89	27.35	No	-	Demise
DaVinci	14	ADCS Mother board	1	PCB	PCB	86	90.17	95.89	9.06	No	-	Demise
DaVinci	15	Reaction Wheel Daughter Board	1	Stainless Steel (120g of total)	PCB/Box	239	90.17	95.89	44.49	Yes	1450	See Tables 4-6
DaVinci	16	Harnesses	20	Copper	Cylinder/wire	22.5	-	-	-	No	-	Demise
DaVinci	17	Spacers	1	Aluminium 6082	Cylinder	16.4	-	-	-	No	-	Demise
DaVinci	18	Engraved Plate	1	Aluminium 6082	Rectangle	28	-	-	-	No	-	Demise
DaVinci	19	EPS	1	PCB	PCB	178	-	-	-	No	-	Demise
DaVinci	20	Spacing Headers	1	-	-	16	-	-	-	No	-	Demise

Appendix F. ELaNa-19 Component List by CubeSat: ISX (1/2)

CUBESAT	Row Number	Name	Qty	Material	Body Type	Individual Mass (g)	Diameter/Width (mm)	Length (mm)	Height (mm)	High Temp	Melting Temp	Survivability
ISX	1	ISX 3U CubeSat	1	Various	Box	3699.3	100	100	340.5	No	-	Demise
ISX	2	CubeSat Structure	1	Aluminum 6061	Box	456	100	100	340.5	No	-	Demise
ISX	3	+Z Panel	1	PCB	Box	30	100	100	2.5	No	-	Demise
ISX	4	-Z Panel	1	PCB	Box	30	100	100	2.5	No	-	Demise
ISX	5	Radio Daughter Board	1	PCB	Box	15	36	83	2.5	No	-	Demise
ISX	6	GPS Daughter Board	1	PCB	Box	15	39	83	2.5	No	-	Demise
ISX	7	GPS Patch	1	Ceramic	Box	11.4	25.1	25.1	5.2	No	-	Demise
ISX	8	C-Band Patch	1	Ceramic	Box	2.1	12	12	4.3	No	-	Demise
ISX	9	Antenna Routes	3	Delrin	Box	5	65	65	3.4	No	-	Demise
ISX	10	Antenna	6	Nitonol Wire	Box	2	0.31	165	0.51	No	-	Demise
ISX	11	System Board	1	PCB	Box	60	100	83	3	No	-	Demise
ISX	12	Payload Interface and Battery Board	1	PCB	Box	50	83	83	3	No	-	Demise
ISX	13	Side Panel	4	PCB	Box	120	83	320	2.5	No	-	Demise
ISX	14	Solar Cell	20	Eglass	Box	2.3	70	40	0.5	No	-	Demise
ISX	15	Solar Angle Sensor Board	5	PCB	Box	5	20	30	2.5	No	-	Demise
ISX	16	Solar Angle Sensor Apperture	5	Aluminum	Box	3	19	21	5	No	-	Demise
ISX	17	Battery Bracket	1	Aluminum 6061	Box	168	76	82	67	No	-	Demise
ISX	18	Heat Shrink	2	RNF-100 Polyolefin Heat Shrink	Tube	2	63.5	25.4	0.5	No	-	Demise
ISX	19	Batteries	9	Lithion Ion	Cylinder	45	18.4	65.1	N/A	No	-	Demise
ISX	20	Dummy Cell	1	Delrin	Cylinder	10	19	66	N/A	No	-	Demise

ELaNa-19 Component List by CubeSat: ISX (2/2)

CUBESAT	Row Number	Name	Qty	Material	Body Type	Individual Mass (g)	Diameter/Width (mm)	Length (mm)	Height (mm)	High Temp	Melting Temp	Survivability
ISX	21	Magnets	4	NdFeB	Cylinder	5	14.3	3.2	N/A	Yes	1300	See Tables 4-6
ISX	22	Historesis Material	4	HyMu80	Cylinder	2.6	2.3	50	N/A	Yes	1454	See Tables 4-6
ISX	23	Magnetorquer Route	3	Delrin	Box	5	78	58	4	No	-	Demise
ISX	24	Magnetorquer Wire	3	Copper	Cylinder	9	3	260	N/A	No	-	Demise
ISX	25	Screw - Representative	120	Stainless Steel 316	Cylinder	0.87	2.8	10	N/A	Yes	1510	See Tables 4-6
ISX	26	Processor Housing	1	Aluminum 6061	Box	725	94.5	98.5	60	No	-	Demise
ISX	27	Processor Board 1	1	PCB	Box	87	75	89	3	No	-	Demise
ISX	28	Processor Board 2	1	PCB	Box	42	75	89	3	No	-	Demise
ISX	29	Processor Board 3	1	PCB	Box	50	75	89	3	No	-	Demise
ISX	30	RF Front End Housing	1	Aluminum 6061	Box	225	94.5	98.5	30	No	-	Demise
ISX	31	RF Front End Board 1	1	PCB	Box	39	75	89	3	No	-	Demise
ISX	32	RF Front End Board 2	1	PCB	Box	40	75	89	3	No	-	Demise
ISX	33	RF Front End Board 3	1	PCB	Box	32	75	89	3	No	-	Demise
ISX	34	Cband Housing	1	Aluminum 6061	Box	130	94.5	98.5	20	No	-	Demise
ISX	35	Cband Board	1	PCB	Box	44	75	89	3	No	-	Demise
ISX	36	Payload Heat Shrink	1	Polyolefin	Tube	5	20	100	0.5	No	-	Demise
ISX	37	Payload Dielectric	1	PTFE	Box	10	10	10	10	No	-	Demise
ISX	38	SMB Connectors	4	Brass	Box	5	17	6.5	14	No	-	Demise
ISX	39	Cabling	3	Copper	Ribbon	40	25.4	340	0.5	No	-	Demise
ISX	40	Staking Compound	1	3M Scotch Weld 2216	Rectangular	50	N/A	N/A	N/A	No	-	Demise
ISX	41	Kapton Tape	1	Kapton Tape	Tape	0	Various	Various	0.05	No	-	Demise
ISX	42	Sep/Actuating Switches	2	Plastic (PBT)	Rectangular	2	6	8	7	No	-	Demise
ISX	43	Payload Cable Bundles	1	Plastic (PBT)	Cylinder	20	10	50	N/A	No	-	Demise
ISX	44	Conformal Coating	1	Arathane 5750	Coating	30	N/A	N/A	N/A	No	-	Demise

Appendix G. ELaNa-19 Component List by CubeSat: NMTSat (1/2)

CUBESAT	Row Number	Name	Qty	Material	Body Type	Individual Mass (g)	Diameter/ Width (mm)	Length (mm)	Height (mm)	High Temp	Melting Temp	Survivability
NMTsat	1	3U CubeSat structure	1	Aluminum 6061	Box	396.893	99.87	99.87	340.53	No	-	Demise
NMTsat	2	Structural Rods	4	18-8 Stainless Steel	Rods	49.94	3		98	Yes	1450	See Tables 4-6
NMTsat	3	Mid plane Standoffs	4	Aluminum 6061	Box	10	99.87	99.87	7	No	-	Demise
NMTsat	4	ISIS Antenna	1	Aluminum 6061	Box (before deployment)	85.162	98	98	5.7	No	-	Demise
NMTsat	5	ISIS screws	4	18-8 Stainless Steel	screws	0.25	4		7.8	Yes	1450	See Tables 4-6
NMTsat	6	ISIS washers	4	18-8 Stainless Steel	Washer	0.05	5		0.711	Yes	1450	See Tables 4-6
NMTsat	7	GAMMA	1	FR-4	PC/104 stack	227.5	90.297	95.885	10	No	-	Demise
NMTsat	8	GAMMA Antenna	1	Aluminum 6061	box	15	38.1	32.055	15.24	No	-	Demise
NMTsat	9	GAMMA Antenna washers	2	18-8 Stainless Steel	whasher	0.05	4.089		0.711	Yes	1450	See Tables 4-6
NMTsat	10	GAMMA Antenna screws	2	18-8 Stainless Steel	screw	0.6	4		9.7	Yes	1450	See Tables 4-6
NMTsat	11	GAMMA Antenna nuts	2	18-8 Stainless Steel	Nut	0.2	3		1	Yes	1450	See Tables 4-6
NMTsat	12	ACS	1	FR-4	PC/104	30	90.297	95.885	15	No	-	Demise
NMTsat	13	Pumpkin Flight board	1	FR-4	PC/104	89.67	90.297	95.885	15	No	-	Demise
NMTsat	14	HE-100 Radio	1	FR-4	PC/104	74.185	90.297	95.885	15	No	-	Demise
NMTsat	15	LPP	1	FR-4	PC/104	29.6	90.297	95.885	15	No	-	Demise
NMTsat	16	PCM	1	FR-4	PC/104	29.6	90.297	95.885	15	No	-	Demise
NMTsat	17	CPU with BeagleBone black	1	FR-4	PC/104	69.28	90.297	95.885	30	No	-	Demise
NMTsat	18	MAG	2	FR-4	PC/104	29.6	90.297	95.885	15	No	-	Demise
NMTsat	19	Buffer	1	FR-4	PC/104	29.6	90.297	95.885	15	No	-	Demise
NMTsat	20	SALLSA	3	FR-4	PC/104 stack	29.6	90.297	95.885	15	No	-	Demise

ELaNa-19 Component List by CubeSat: NMTSat (2/2)

CUBESAT	Row Number	Name	Qty	Material	Body Type	Individual Mass (g)	Diameter/Width (mm)	Length (mm)	Height (mm)	High Temp	Melting Temp	Survivability
NMTsat	21	Power Board	1	FR-4	PC/104	199.58	90.297	95.885	25	No	-	Demise
NMTsat	22	PEEK Screws	8	PEEK	screw	0.16	6.756	-	9.525	No	-	Demise
NMTsat	23	PEEK column	4	PEEK	Cylinder	4.884	12.7	-	28.575	No	-	Demise
NMTsat	24	copper plate (plasma probe)	1	101 Copper	Circular Plate	32.62	60.96	-	3.175	No	-	Demise
NMTsat	25	Stacking Bus Conector	4	Copper alloy with gold plate	Box	6.34	79	12.7	10	No	-	Demise
NMTsat	26	Solar panels	4	FR-4	Rectangualr Plate	96.65	81.73	324.5	1.575	No	-	Demise
NMTsat	27	solar panel screw	8	18-8 stainless steel	screw	0.54	6	-	7.8	Yes	1450	See Tables 4-6
NMTsat	28	solar panel nut	8	18-8 Stainless Steel	nut	0.241	5.5	-	1.8	Yes	1450	See Tables 4-6
NMTsat	29	Solar panel clip	4	18-8 Stainless Steel	box	1.364	15	15	0.3	Yes	1450	See Tables 4-6
NMTsat	30	15mm spacers	36	18-8 Stainless Steel	hex cylinder	4.536	6	-	15	Yes	1450	See Tables 4-6
NMTsat	31	25mm spacers	16	18-8 Stainless Steel	hex cylinder	11.34	6	-	25	Yes	1450	See Tables 4-6
NMTsat	32	RF cables with SSMCX connector	2	Copper alloy	cable	13.608	-	-	-	No	-	Demise
NMTsat	33	Other Cables		Copper alloy	cable	10	-	-	-	No	-	Demise

Appendix H. ELaNa-19 Component List by CubeSat: RSat

CUBESAT	Row Number	Name	Qty	Material	Body Type	Individual Mass (g)	Diameter/Width (mm)	Length (mm)	Height (mm)	High Temp	Melting Temp	Survivability
Rsat	1	RSat CubeSat	1	Aluminium 6061	A-Frame	4000	113	113	340.5	No	-	Demise
Rsat	2	CubeSat Structure	1	Aluminium 6061	A-Frame	750	100	100	340.5	No	-	Demise
Rsat	3	Arms	2	CRP Windform XT	Hollow-core	292	15	15	600	No	-	Demise
Rsat	4	Motors	16	Stainless Steel	Cylinder	19.33	12	39	N/A	Yes	1450	See Tables 4-6
Rsat	5	Solar Panels	6	Fiberglass	Flat pannel	100	83	340.5	1.5	No	-	Demise
Rsat	6	Motor Control Board	32	Fiberglass	Flat pannel	15	15	30	6	No	-	Demise
Rsat	7	Batteries	6	Lithium-Ion	Cylinder	91	18.3	64.8	N/A	No	-	Demise
Rsat	8	ADCS	2	HyMu 80 / Neodymium	Cylinder	100	25.4	5	N/A	Yes	1454	See Tables 4-6
Rsat	9	Comm Board	1	Fiberglass / Aluminium	Box	350	82.5	82.5	17	No	-	Demise
Rsat	10	Battery Frame	2	ABS	Frame	30	50	65	30	No	-	Demise
Rsat	11	C&DH Board	1	PCB	Flat pannel	100	96	327.5	6	No	-	Demise
Rsat	12	Fasteners	~150	Stainless Steel	M2 Screws	1	2	Variable	N/A	Yes	1510	See Tables 4-6
Rsat	13	Sep Switches	2	Plastic	Limit switch	10	10	10	10	No	-	Demise
Rsat	14	Cabling	-	Copper alloy	-	-	-	-	-	No	-	Demise

Appendix I. ELaNa-19 Component List by CubeSat: Shields-1 (1/2)

CUBESAT	Row Number	Name	Qty	Material	Body Type	Individual Mass (g)	Diameter/Width (mm)	Length (mm)	Height (mm)	High Temp	Melting Temp	Survivability
Shields-1	1	Shields-1 3 U CubeSat	1	-	Box	6935.35	10	10	34.05	No	-	Demise
Shields-1	2	Mid Structure-Atomic Z Grade Vault	1	-	Box	-	-	-	-	No		See Tables 4-6
Shields-1	2.1	Shield -1	4	Aluminum 6061	Sheet	56.0099	95.403	135.9	1.6	No	-	Demise
Shields-1	2.2	Shield 0	4	Ti-6-4	Sheet	113.7832	95.403	135.9	1.981	No	1650	See Tables 4-6
Shields-1	2.3	Shield 1	4	Tantalum	Sheet	219.8909792	95.403	135.9	1.016	Yes	2980	See Tables 4-6
Shields-1	2.4	Shield 2	2	Aluminum 6061	Sheet	35.62155203	90.806	90.806	1.6	No	-	Demise
Shields-1	2.5	Shield 3	2	Ti-6-4	Sheet	72.36452329	90.806	90.806	1.981	Yes	1650	See Tables 4-6
Shields-1	2.6	Shield 4	2	Tantalum	Sheet	139.8475746	90.806	90.806	1.016	Yes	2980	See Tables 4-6
Shields-1	2.7	Shield 5	2	Aluminum 6061	Sheet	3.420275484	31.75	-	1.6	No	-	Demise
Shields-1	2.8	Shield 6	2	Ti-6-4	Sheet	8.794904361	31.75	-	1.981	Yes	1650	See Tables 4-6
Shields-1	2.9	Shield 7	2	Tantalum	Sheet	13.4277482	31.75	-	1.016	Yes	2980	See Tables 4-6
Shields-1	3	Bottom Structure-Research Payload	1	Aluminum 6061	Box	2305.392421	100	142	26.1	No	-	Demise
Shields-1	3.1	Al-Ti Z grade Sample		-	-	-	-	-	-	No	-	Demise
Shields-1	3.2	-	1	Aluminum 6061	Sheet	15.00298702	66.497	-	1.6	No	-	Demise
Shields-1	3.3	-	1	Ti-6-4	Sheet	30.4776999	66.497	-	1.981	Yes	1650	See Tables 4-6
Shields-1	3.4	Al-Ti-Ta Z grade Sample (3 g/cm2)		-	-	-	-	-	-	No	-	Demise
Shields-1	3.5	-	1	Aluminum 6061	Sheet	15.00298702	66.497	-	1.6	No	-	Demise
Shields-1	3.6	-	1	Ti-6-4	Sheet	30.4776999	66.497	-	1.981	Yes	1650	See Tables 4-6
Shields-1	3.7	-	1	Ta	Sheet	14.7225828	66.497	-	0.254	No	-	Demise
Shields-1	3.8	Al-Ti-Ta Z grade Sample (3 g/cm2)	-	-	-	-	-	-	-	No	-	Demise
Shields-1	3.9	-	1	Aluminum 6061	Sheet	15.00298702	66.497	-	1.6	No	-	Demise
Shields-1	3.10	-	1	Ti-6-4	Sheet	30.4776999	66.497	-	1.981	Yes	1650	See Tables 4-6
Shields-1	3.11	-	1	Ta	Sheet	58.8903312	66.497	-	1.016	No	-	Demise
Shields-1	4	Top Structure-Antenna Housing	1	eg. Aluminum 6061	Box	356	100	46.7	100	No	-	Demise

ELaNa-19 Component List by CubeSat: Shields-1 (2/2)

CUBESAT	Row Number	Name	Qty	Material	Body Type	Individual Mass (g)	Diameter/ Width (mm)	Length (mm)	Height (mm)	High Temp	Melting Temp	Survivability
Shields-1	5	Battery Board	1	Lithium-Ion, PCB	Board	310	87	87	1.6	No	-	Demise
Shields-1	6	Antenna	1	Al 6061, PCB	box	89	100	100	6.5	No	-	Demise
Shields-1	7	FCPU and Comm Board	1	Al, PCB	Board	92	87	87	1.6	No	-	Demise
Shields-1	8	Research Payload Board	2	PCB	Board	90	87	87	1.6	No	-	Demise
Shields-1	9	EPS Board	1	PCB	-	87.8	87	87	1.6	No	-	Demise
Shields-1	9.1	Voltage Booster	1	Kovar, PCB	box	75.7	30	50	10	No	-	Demise
Shields-1	9.2	Voltage Booster Heat Sink	1	Aluminum	frame	32.39	30	50	10	No	-	Demise
Shields-1	10	Charge Dissipation Film electrodes	4	SS 305	disk	35.73	25.4		2.921	Yes	1538	See Tables 4-6
Shields-1	10.1	Charge Dissipation Film spring	1	stainless steel	spring	5	6.3	12.7	-	Yes	1650	See Tables 4-6
Shields-1	11	Charge Dissipation Film housing	1	Ultem	Cylinder	32.8	38.1	25.4	-	No	-	Demise
Shields-1	11.1	Antenna Rf Connector	1	Copper/Gold	Cable	5.01	-	-	-	No	-	Demise
Shields-1	11.2	Omnetics antenna Cabling 9 pin	1	Copper/Gold	-	4.75	-	-	-	No	-	Demise
Shields-1	12	Omnetics Research Payload Cabling	3	Copper	-	25	-	-	-	No	-	Demise
Shields-1	13	RTDs	10	Stainless Steel, Al, Cu	-	1.89	-	-	-	Yes	1650	See Tables 4-6
Shields-1	14	Microdosimeters	8	Kovar, PCB	-	20	35.6	25.4	1.016	No	-	Demise
Shields-1	15	Solar Panels	4	Triple Junction GaAs	Board	112.33	83.2	317	2.108	No	-	Demise
Shields-1	16	Fasteners	76	A86 stainless	Screw	0.5171	2.845	4.7752	-	Yes	1510	See Tables 4-6
Shields-1	17	Fasteners	66	A86 stainless	Screw	0.5171	2.184	3.048	-	Yes	1510	See Tables 4-6
Shields-1	18	Fasteners	8	A86 stainless	Screw	0.5171	8	6.35	-	Yes	1510	See Tables 4-6
Shields-1	19	Solar Panel Screws	24	SS 4130	Screws	0.25	1.5875	6.35	-	Yes	1510	See Tables 4-6
Shields-1	19	Solar Panel Washers	24	SS 4130	Washers	1.00	3.175	1.5875	-	Yes	1510	See Tables 4-6
Shields-1	20	Charge Dissipation Film	2	Acrylic	-	0.03	25.4	-	0.0508	No	-	Demise
Shields-1	21	Remove Before Flight Pin	1	Stainless Steel, Al	switch	20	25.4	12.5	12.5	Yes	1510	See Tables 4-6
Shields-1	22	Sep Switch	1	PCB stainless steel	switch	20	25.4	12.5	12.5	Yes	1510	See Tables 4-6
Shields-1	23	ADCS Components (eg. Magnets)	1	AlNiCo	Rod	11	6.4	-	35.6	No	-	Demise
Shields-1	24	ADCS Components (Hysteresis Rods)	3	Hymu80	Rod	13	1.588	-	70	Yes	1454	See Tables 4-6

Appendix J. ELaNa-19 Component List by CubeSat: STF-1

CUBESAT	Row Number	Name	Qty	Material	Body Type	Mass (g) (Ind)	Diameter/Width (mm)	Length (mm)	Height (mm)	High Temp	Melting Temp	Survivability
STF-1	1	STF-1 3U CubeSat	1		Box					No	-	Demise
STF-1	2	CubeSat Structure	1	Aluminum 6082	Box	513	100	100	340.5	No	-	Demise
STF-1	3	UHF Antenna	1	PCB, Aluminum	Box	114	102	102	7.13	No	-	Demise
STF-1	3	UHF Element	2	NiTi-Alloy	Box	inc. w/ row 3	0.19	15.4	3.1	No	-	Demise
STF-1	4	1U Solar Panel	1	PCB	Box	43	98	98	1.57	No	-	Demise
STF-1	5	3U Solar Panel	4	PCB	Box	150.5	82.6	337	1.57	No	-	Demise
STF-1	6	Sep Switches	2	Aluminum	Thin Wall Cylinder	2.35 est	5.05	11.8		No	-	Demise
STF-1	7	GPS Antenna	1	Composite Radome/Aluminum -T6	Box	88	52.78	52.78	17.53	No	-	Demise
STF-1	8	LP Element	2	NiTi-Alloy	Box	inc. w/ row 3	0.19	588.96	3.1	No	-	Demise
STF-1	9	Radio	1	PCB/ Aluminum	Box	87	69	69	13.5	No	-	Demise
STF-1	10	Battery	2	PCB/Lithium Polymer	Box	338	90.17	95.89	26.7	No	-	Demise
STF-1	11	EPS	1	PCB	Box	178	90.17	95.89	15.4	No	-	Demise
STF-1	12	Special Services Board	1	PCB	Box	250 est	90.17	95.89	18.09	No	-	Demise
STF-1	13	C&DH Board	1	PCB	Box	89	88.88	91.98	23.25	No	-	Demise
STF-1	14	Fasteners		Stainless Steel	Solid Cylinder	120 est	3.048		-	Yes	1510	See Tables 4-6
STF-1	15	Cabling		Copper alloy/ Teflon	-	80 est	-	-	-	No	-	Demise
STF-1	16	Connectors		Tin/Gold/ABS	-	96 est	-	-	-	No	-	Demise
STF-1	17	CSEE Experiment Board	1	PCB	Box	122	90.17	95.89	22.19	No	-	Demise
STF-1	17	Ferrite Bead	1	Ferrite	Box	0.03	2	1.2	0.9	Yes	1539	See Tables 4-6
STF-1	17	LED Chip Carrier	3	Al2O3 (Ceramic)	Box	<1.0	10.17	10.17	1.27	No	-	Demise
STF-1	18	Physics Experiment Board	1	PCB	Box	191	90.17	95.89	19	No	-	Demise
STF-1	18	Geiger Tube	2	Stainless Steel/Mica/Neon/Argon	Thin Wall Cylinder	inc. w/ row 15	15	43	-	Yes	1539	See Tables 4-6
STF-1	19	IMU Experiment Board	1	PCB	Box	47	90.17	95.89	2.6	No	-	Demise
STF-1	20	Camera	1	PCB	Box	8	24	34	3	No	-	Demise
STF-1	20	Camera Lens	1	ABS/Glass	Solid Cylinder	inc. w/ row 17	13.1	14.75		No	-	Demise
STF-1	21	Debug Port	1	Aluminum/Silicon/Copper	Box	44	10.5	33.6	7.5			

Appendix K. ELaNa-19 Component List by CubeSat: TOMSat EAGLESCOUT

CUBESAT	Row Number	Name	Qty	Material	Body Type	Individual Mass (g)	Diameter/ Width (mm)	Length (mm)	Height (mm)	High Temp	Melting Temp	Survivability
TOMSat EAGLEScout	1	Full Body Only	1	6061-T6	Box	644	103.494	110.9	340.5	No	-	Demise
TOMSat EAGLEScout	2	Frame Part 1 (2001)	1	6061-T6	Box	298	103.494	110.9	130	No	-	Demise
TOMSat EAGLEScout	3	Frame Part 2 (4001)	1	6061-T6	Box	346	103.494	110.9	209.23	No	-	Demise
TOMSat EAGLEScout	4	Bus Electronics	1	FR4	Box	627	85.046	84.882	97.05	No	-	Demise
TOMSat EAGLEScout	5	Reaction Wheels	1	Stainless	Box	225	52.832	71.102	39.192	Yes	1450	See Tables 4-6
TOMSat EAGLEScout	6	Star Tracker	2	6061-T6 (65%), glass (25%), FR4 (10%)	Box	55	26.67	25.4	41.829	No	-	Demise
TOMSat EAGLEScout	7	Single Torque Rod	9	HyMu 80	Cylinder	18	8	78.74	-	Yes	1300	See Tables 4-6
TOMSat EAGLEScout	8	Zenith Lid Assembly	1	6061-T6	Box	141	103.494	110.9	16.74	No	-	Demise
TOMSat EAGLEScout	9	Antenna	2	Ceramic (95%) with copper foil (5%)	Plate	16	39.878	38.099	3.277	No	-	Demise
TOMSat EAGLEScout	10	Wing Assembly	2	6061-T6	Plate	148	2.677	313.5	73.66	No	-	Demise
TOMSat EAGLEScout	11	Nadir Lid Assembly	1	6061-T6	Box	100	103.494	110.9	7.977	No	-	Demise
TOMSat EAGLEScout	12	Antenna	1	Ceramic (95%) with copper foil (5%)	Plate	16	39.878	38.099	3.277	No	-	Demise
TOMSat EAGLEScout	13	Uplink Receiver	1	6061-T6 (75%), glass (25%)	Cylinder	28	31	31.601	-	No	-	Demise
TOMSat EAGLEScout	14	Payload Assembly	1	6061-T6 (45%), glass (45%), FR4 (10%)	Box	1311	82.444	164.58	56.238	No	-	Demise
TOMSat EAGLEScout	15	18267	1	Titanium	Cylinder	17	32	37.275	-	Yes	1650	See Tables 4-6
TOMSat EAGLEScout	16	18265	1	Titanium	Cylinder	11	32	16.506	-	Yes	1650	See Tables 4-6
TOMSat EAGLEScout	17	18264	1	Titanium	Cylinder	12	32	25.999	-	Yes	1650	See Tables 4-6
TOMSat EAGLEScout	18	18268	1	Titanium	Cylinder	4	39	2.5	-	Yes	1650	See Tables 4-6
TOMSat EAGLEScout	19	18266	1	Titanium	Cylinder	10	32	5.081	-	Yes	1650	See Tables 4-6
TOMSat EAGLEScout	20	18263	1	Titanium	Cylinder	1	32	1.649	-	Yes	1650	See Tables 4-6
TOMSat EAGLEScout	21	18270	1	Titanium	Cylinder	1	32	1.601	-	Yes	1650	See Tables 4-6
TOMSat EAGLEScout	22	Laser	1	6061-T6 (90%), stainless steel (10%)	Box	353	82.245	120.65	20.192	Yes	~1650	See Tables 4-6
TOMSat EAGLEScout	23	STIM 210 IMU	1	6061-T6	Box	116	48.26	64.77	25.4	No	-	Demise

Appendix L. ELaN-19 Component List by CubeSat: TOMSat R3

CUBESAT	Row Number	Name	Qty	Material	Body Type	Individual Mass (g)	Diameter/ Width (mm)	Length (mm)	Height (mm)	High Temp	Melting Temp	Survivability
TOMSat R3	1	Full Body Only	1	6061-T6	Box	644	103.494	110.9	340.5	No	-	Demise
TOMSat R3	2	Frame Part 1 (2001)	1	6061-T6	Box	298	103.494	110.9	130	No	-	Demise
TOMSat R3	3	Frame Part 2 (4001)	1	6061-T6	Box	346	103.494	110.9	209.23	No	-	Demise
TOMSat R3	4	Bus Electronics	1	FR4	Box	627	85.046	84.882	97.05	No	-	Demise
TOMSat R3	5	Reaction Wheels	1	Stainless	Box	225	52.832	71.102	39.192	Yes	1450	See Tables 4-6
TOMSat R3	6	Star Tracker	2	6061-T6 (65%), glass (25%), FR4 (10%)	Box	55	26.67	25.4	41.829	No	-	Demise
TOMSat R3	7	Single Torque Rod	9	HyMu 80	Cylinder	18	8	78.74	-	Yes	1300	See Tables 4-6
TOMSat R3	8	Zenith Lid Assembly	1	6061-T6	Box	141	103.494	110.9	16.74	No	-	Demise
TOMSat R3	9	Antenna	2	Ceramic (95%) with copper foil (5%)	Plate	16	39.878	38.099	3.277	No	-	Demise
TOMSat R3	10	Wing Assembly	2	6061-T6	Plate	148	2.677	313.5	73.66	No	-	Demise
TOMSat R3	11	Nadir Lid Assembly	1	6061-T6	Box	100	103.494	110.9	7.977	No	-	Demise
TOMSat R3	12	Antenna	1	Ceramic (95%) with copper foil (5%)	Plate	16	39.878	38.099	3.277	No	-	Demise
TOMSat R3	13	Uplink Receiver	1	6061-T6 (75%), glass (25%)	Cylinder	28	31	31.601	-	No	-	Demise
TOMSat R3	14	Payload Assembly	1	6061-T6 (45%), glass (45%), FR4 (10%)	Box	1311	82.444	164.58	56.238	No	-	Demise
TOMSat R3	15	18267	1	Titanium	Cylinder - Hollow	17	32	37.275	-	Yes	1650	See Tables 4-6
TOMSat R3	16	18265	1	Titanium	Cylinder - Hollow	11	32	16.506	-	Yes	1650	See Tables 4-6
TOMSat R3	17	18264	1	Titanium	Cylinder - Hollow	12	32	25.999	-	Yes	1650	See Tables 4-6
TOMSat R3	18	18268	1	Titanium	Cylinder - Hollow	4	39	2.5	-	Yes	1650	See Tables 4-6
TOMSat R3	19	18266	1	Titanium	Cylinder - Hollow	10	32	5.081	-	Yes	1650	See Tables 4-6
TOMSat R3	20	18263	1	Titanium	Cylinder - Hollow	1	32	1.649	-	Yes	1650	See Tables 4-6
TOMSat R3	21	18270	1	Titanium	Cylinder - Hollow	1	32	1.601	-	Yes	1650	See Tables 4-6
TOMSat R3	22	Laser	1	6061-T6 (90%), stainless steel (10%)	Box	353	82.245	120.65	20.192	Yes	~1650	See Tables 4-6
TOMSat R3	23	STIM 210 IMU	1	6061-T6	Box	116	48.26	64.77	25.4	No	-	Demise

Appendix M. ELaNa-19 Component List by CubeSat: SHFT-1

CUBESAT	Row Number	Name	Qty	Material	Body Type	Individual Mass (g)	Diameter/ Width (mm)	Length (mm)	Height (mm)	High Temp	Melting Temp	Survivability
SHFT-1	1	3U CubeSat	1		Box	5100	113.1	365.8	112.48	No	-	Demise
SHFT-1	2	CubeSat Structure	1	Al 7075-T651	Box	378.7	100	270.7	100	No	-	Demise
SHFT-1	3	Antenna - deployed	4	Steel, Ultem, Al 6061	Boom	458.1	19.05	6000	0.28	No	-	Demise
SHFT-1	4	Solar Panels - deployed	2	FR4, glass, Al 6061	Flat Plate	305	138.38	326.49	57.25	No	-	Demise
SHFT-1	5	ADCS	1	Al 6061	Box	895	100	100	50	No	-	Demise
SHFT-1	6	UHF/GPS Antenna System - deployed	1	Al 6061, brass, RO3006 005 R3	Box	260.3	274	274	115.42	No	-	Demise
SHFT-1	7	S-Band Antenna	1	AD350A, RO450F, RO4003C	Box	75	83.82	83.82	5.08	No	-	Demise
SHFT-1	8	Rails	2	Al 7075-T651	Flat Plate	39.9	13.5	366	2.95	No	-	Demise
SHFT-1	9	IXC/GPS Board	1	Polyimide	Box	107.2	95.88	90.17	15.75	No	-	Demise
SHFT-1	10	SBC Board	1	Polyimide	Flat Plate	88.5	95.88	90.17	10.9	No	-	Demise
SHFT-1	11	EPS Boards with Spacers	1	Polyimide, Al 6061	Box	218.6	95.88	90.17	24.94	No	-	Demise
SHFT-1	12	Battery Assembly	1	Polyimide, Al 6061, 2200SF gap pad, Li Ion	Box	298.6	95.88	90.17	27.35	No	-	Demise
SHFT-1	13	Radio	1	OFHC Copper, Al 6061, Polyimide	Box	576	96.65	96.65	30.91	No	-	Demise
SHFT-1	14	Payload Boards	1	Polyimide, Al 7075	Box	1093.9	116	96.65	76	No	-	Demise
SHFT-1	15	Internal Fasteners	85	18-8 SSSL, 316 SSSL, Alloy Steel	cylinder	1	3 (head 5mm)	10		Yes	1400	See Table 4-6
SHFT-1	16	External Fasteners	134	18-8 SSSL, 316 SSSL	cylinder	1	3 (head 5mm)	10		Yes	1400	See Table 4-6
SHFT-1	17	External Covers	6	Al 6061	flat plate	3.4	1.60	20	40	No	-	Demise
SHFT-1	18	Internal Cabling		Copper Alloy	wires	50	0.5	150		No	-	Demise

Appendix N. ELaNa-19 Component List by CubeSat: ALBus

CUBESAT	Item Number	Name	Qty	Material	Body Type	Mass (g) (total)	Diameter/ Width (mm)	Length (mm)	Height (mm)	High Temp	Melting Temp (F°)	Survivability
ALBus	1.1	Discharge Board	1	PCB	Box	50	95	95	3	No	-	Demise
ALBus	1.2	MSP430 Board	1	PCB	Box	50	95	95	3	No	-	Demise
ALBus	1.3	Boost Convertor Board	1	PCB	Box	50	95	95	3	No	-	Demise
ALBus	1.4	Battery Pack /(GOMSpace Battery)	1	Aluminum 7075	Cylinder	720	94	88	20	No	-	Demise
ALBus	1.7	Threaded rod	2	Stainless Steel	Cylinder	136	2.8	50	--	Yes	2642°	Demise
ALBus	2.1.1	Baseplate	1	Aluminum 7075	Box	33	95	95	95	Yes	1175°	Demise
ALBus	2.1.2	Release slide post	4	Stainless Steel	Cylinder	3.5	3.2	21	21	No	-	Demise
ALBus	2.1.5	SMA actuator	1	NiTi	Cylinder	<1g	0.3	59	59	Yes	2370°	Demise
ALBus	2.1.9	Release plate	1	Aluminum 7075	Box	30	95	95	95	No	-	Demise
ALBus	2.2.1	Auxiliary Board	1	PCB-FR4	Box	50	95	95	95	No	-	Demise
ALBus	3.1	Radio Support Board	1	PCB-FR4	Box	50	95	95	95	No	-	Demise
ALBus	3.5	Radio Board	1	PCB-FR4	Box	50	95	95	95	No	-	Demise
ALBus	4.1.1	Solar panel Substrate	4	PCB-FR4	rectangular prism	80	83	315	0.76	No	-	Demise
ALBus	4.1.2	SMA Spring	8	NiTi	rectangular prism	3.6	15	55	0.7	Yes	2370°	Demise
ALBus	4.1.3	Lugs	4	Stainless Steel	cylinder	5.4	11	21	1.3	No	-	Demise
ALBus	4.1.5	Hinge pin	4	Stainless Steel	cylinder	20	3.175	76	---	No	-	Demise
ALBus	4.2.5	Gravity Gradient Mass	4	Stainless Steel	rectangular prism	40	63.5	38.1	2.1	Yes	-	Demise
ALBus	4.3.1	Heat Sink	1	Aluminum 6061	rectangular prism	350	100	100	16	No	-	Demise
ALBus	4.3.2	Hinge brackets	4	Aluminum 7075	cube	7	14	14	5	No	-	Demise
ALBus	4.3.8	Lock hook	4	Stainless Steel	rectangular prism	1	5	5	0.5	No	-	Demise
ALBus	5.1	Load Bank Board	1	PCB	Box	75	95	95	10	No	-	Demise
ALBus	6.1	Chassis	1	Aluminum 7075	Box	210	98	98	307	No	-	Demise
ALBus	6.4	Body mounted solar array	4	FR4 PCB	Box	54	54	83	.76	No	-	Demise

ALBus	7.1	Screws	97	Stainless Steel 304	Cylinder	43.16	Various	-	-	Yes	2642°	Demise
ALBus	7.2	Nuts	32	Stainless Steel 304/ Nylon	Cylinder	16.84	Various	-	-	No	-	Demise
ALBus	7.3	Spacers	28	Stainless Steel 304	Cylinder	12.56	Various	-	-	Yes	2642°	Demise