



BASIC MANUAL

VHF AIR BAND TRANSCEIVERS

IC-A120 IC-A120E



This device complies with Part 15 of the FCC Rules. Operation is subject to the condition that this device does not cause harmful interference.

Icom Inc.

IMPORTANT

READ ALL INSTRUCTIONS carefully and completely before using the transceiver.

SAVE THIS INSTRUCTION MANUAL — This instruction manual contains important operating instructions for the IC-A120 and IC-A120E.

EXPLICIT DEFINITIONS











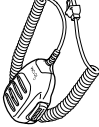

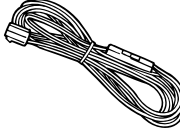
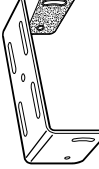
The explicit definitions below apply to this instruction manual.

WORD	DEFINITION
⚠ WARNING!	Personal injury, fire hazard or electric shock may occur.
CAUTION	Equipment damage may occur.
NOTE	If disregarded, inconvenience only. No risk of personal injury, fire or electric shock.

CAUTION: Changes or modifications to this transceiver, not expressly approved by Icom Inc., could void your authority to operate this transceiver under FCC regulations.

About E-marking: Detailed installation notes for Icom mobile transceivers to be fitted into vehicles are available. Please contact your Icom dealer or distributor.

SUPPLIED ACCESSORIES

Microphone 	Microphone hanger 	Microphone hanger cable 
DC power cable 	Mounting bracket 	Sponges* 
Flat washers 	Bracket bolts 	Self-tapping screws (5x16) 
Spring washers 	Mounting screws (5x12) 	Self-tapping screws (3x16, for Microphone hanger) 
Nuts 	Fuses (10 A) 	

* Used for optional unit installation. Ask the technical dealer for details.

PRECAUTIONS

- ⚠ **WARNING! NEVER** connect the transceiver to an AC outlet. This may pose a fire hazard or result in an electric shock.
- ⚠ **WARNING! NEVER** connect the transceiver to a power source of more than 31.5 V DC. This could damage the transceiver.
- ⚠ **WARNING! NEVER** cut the DC power cable between the DC plug and fuse holder. If an incorrect connection is made after cutting, the transceiver might be damaged.
- ⚠ **WARNING! NEVER** place the transceiver where normal operation of the vehicle may be hindered or where it could cause bodily injury.
- CAUTION: NEVER** expose the transceiver to rain, snow or any liquids.
- DO NOT** operate or place the transceiver in areas with temperatures below -30°C (-22°F) or above $+60^{\circ}\text{C}$ ($+140^{\circ}\text{F}$), or in areas subject to direct sunlight, such as the dashboard.
- DO NOT** operate the transceiver without running the vehicle's engine. The vehicle's battery will quickly run out when the transceiver transmits while the vehicle's engine is OFF.
- DO NOT** place the transceiver in excessively dusty environments.
- DO NOT** place the transceiver against walls. Otherwise heat dissipation will be obstructed.
- DO NOT** use harsh solvents such as benzene or alcohol when cleaning, as they damage the transceiver surfaces.

BE CAREFUL! The transceiver will become hot when operating continuously for long periods.

USE the specified microphone only. Other microphones have different pin assignments and may damage the transceiver.

Place the transceiver in a secure place to avoid inadvertent use by children.

KEEP the transceiver away from the heavy rain, and never immerse it in the water. The transceiver meets IP54* requirements for dust-protection and splash resistance. However, once the transceiver has been dropped, dust protection and splash resistance cannot be guaranteed due to the fact that the transceiver may be cracked, or the waterproof seal damaged, and so on.
*Only when the supplied microphone is attached.

CAUTION: In Canada, use of 8.33 kHz Channel Spacing of this radio is strictly prohibited and shall not be used.

Icom, Icom Inc. and Icom logo are registered trademarks of Icom Incorporated (Japan) in Japan, the United States, the United Kingdom, Germany, France, Spain, Russia, Australia, New Zealand, and/or other countries.

The Bluetooth word mark and logos are registered trademarks owned by Bluetooth SIG, Inc. and any use of such marks by Icom Inc. is under license. All other products or brands are registered trademarks or trademarks of their respective holders.

PRÉCAUTIONS

- ⚠ **AVERTISSEMENT! NE JAMAIS** connecter l'émetteur-récepteur à une alimentation CA au risque de provoquer un incendie ou un choc électrique.
- ⚠ **AVERTISSEMENT! NE JAMAIS** brancher l'émetteur-récepteur sur une source d'alimentation de plus de 31,5 V CC. **NE JAMAIS** émettre lorsque le coupleur est activé (ON), alors qu'aucune antenne n'est raccordée, au risque d'endommager gravement l'émetteur-récepteur.
- ⚠ **AVERTISSEMENT! NE JAMAIS** couper le câble d'alimentation CC entre la prise CC à l'arrière de l'émetteur-récepteur et le porte fusible. L'émetteur-récepteur peut être endommagé par la suite en cas de connexion inappropriée.
- MISE EN GARDE: NE JAMAIS** placer l'émetteur-récepteur à un emplacement où il pourrait gêner le fonctionnement normal du navire ou provoquer des blessures corporelles.
- MISE EN GARDE: NE JAMAIS** exposer l'émetteur-récepteur à la pluie, à la neige ou à tout autre liquide.
- NE PAS** utiliser ou placer l'émetteur-récepteur dans des zones où la température est inférieure à -30°C (-22°F) ou supérieure à +60°C (+140°F) ou dans des zones soumises au rayonnement solaire direct, telles le tableau de bord.
- En utilisation mobile, **NE PAS** utiliser un émetteur-récepteur embarqué avec le moteur du véhicule arrêté. La batterie du véhicule sera rapidement épuisée lorsque la radio transmet lorsque le moteur du véhicule est éteint.

NE PAS placer l'émetteur-récepteur dans un environnement excessivement poussiéreux ou en plein soleil.

NE PAS placer l'émetteur-récepteur contre un mur pour ne pas gêner la dispersion de la chaleur.

NE PAS utiliser de solvants agressifs tels que l'essence ou l'alcool pour nettoyer le l'émetteur-récepteur, en raison des risques d'endommager la surface du l'émetteur-récepteur.

ATTENTION! L'émetteur-récepteur chauffe en cas d'utilisation continue sur une longue durée.

Utiliser exclusivement un microphone Icom (fourni d'origine ou en option). La réparation des broches des microphones des autres fabricants est différente et leur connexion à l'IC-A120/IC-A120E peut endommager l'émetteur-récepteur.

Placer l'émetteur-récepteur hors de portée des enfants pour éviter toute utilisation inopinée.

PLACEZ l'émetteur-récepteur loin d'une forte pluie et ne jamais l'immerger dans l'eau. Cet émetteur-récepteur répond aux exigences de la norme IP54* en matière de protection contre la poussière et de résistance aux éclaboussures. Toutefois, si l'émetteur-récepteur tombe par terre, la protection contre la poussière et la résistance aux éclaboussures ne peuvent être garanties, car l'appareil peut être fissuré ou le joint d'étanchéité peut être endommagé, etc.

*Seulement lorsque le microphone fourni est fixé.

MISE EN GARDE: Utilisation de 8,33 kHz Espacement des canaux de cette radio est strictement interdite et ne doit pas être utilisé au Canada.

SAFETY TRAINING INFORMATION



Your Icom radio generates RF electromagnetic energy during transmit mode. This radio is designed for and classified as “Occupational Use Only,” meaning it must be used only during the course of employment by individuals aware of the hazards, and the ways to minimize such hazards. This radio is **NOT** intended for use by the “General Population” in an uncontrolled environment.

- For compliance with FCC and Industry Canada RF Exposure Requirements, the transmitter antenna installation shall comply with the following two conditions:
 1. The transmitter antenna gain shall not exceed 0 dBi.
 2. The antenna is required to be located outside of a vehicle and kept at a distance of 53 centimeters or more between the transmitting antenna of this device and any persons during operation. For a small vehicle, the antenna as worst case, the antenna shall be located on the roof top at any place on the centre line along the vehicle in order to achieve 53 centimeters separation distance. In order to ensure this distance is met, the installation of the antenna must be mounted at least 53 centimeters away from the nearest edge of the vehicle in order to protect against exposure to bystanders.



To ensure that your exposure to RF electromagnetic energy is within the FCC allowable limits for occupational use, always adhere to the following guidelines:

- **DO NOT** operate the radio without a proper antenna attached, as this may damage the radio and may also cause you to exceed FCC RF exposure limits. A proper antenna is the antenna supplied with this radio by the manufacturer or an antenna specifically authorized by the manufacturer for use with this radio.
- **DO NOT** transmit for more than 50% of total radio use time (“50% duty cycle”). Transmitting more than 50% of the time can cause FCC RF exposure compliance requirements to be exceeded. The radio is transmitting when the “TX” indicator appears. You can cause the radio to transmit by pressing the PTT switch.

Electromagnetic Interference/Compatibility

During transmissions, your Icom radio generates RF energy that can possibly cause interference with other devices or systems. To avoid such interference, turn off the radio in areas where signs are posted to do so. **DO NOT** operate the transmitter in areas that are sensitive to electromagnetic radiation such as hospitals, aircraft, and blasting sites.

INFORMATION EN MATIÈRE DE SÉCURITÉ



Votre radio Icom produit une énergie électromagnétique de radiofréquences (RF), en mode de transmission. Cette radio est conçue pour un «usage professionnel seulement» et classée comme tel, ce qui signifie qu'elle doit être utilisée uniquement dans le cadre d'un travail par des personnes conscientes des dangers et des mesures visant à minimiser ces dangers. Elle N'EST PAS conçue pour une «utilisation grand public», dans un environnement non contrôlé.

• Afin de satisfaire aux exigences de la FCC et d'Industrie Canada en matière d'exposition aux RF, il est nécessaire que l'antenne soit installée conformément aux deux conditions suivantes:

1. Le gain de l'antenne du radio émetteur ne doit pas dépasser 0 dBi.
2. Il faut que l'antenne émettrice de cet appareil soit placée à l'extérieur d'un véhicule et tenue éloignée d'au moins 53 centimètres de toute personne pendant le fonctionnement. Dans le pire des cas, pour un petit véhicule, l'antenne doit être placée sur le toit, n'importe où dans l'axe central du véhicule, afin de respecter une distance de 53 cm du bord le plus rapproché du véhicule et ainsi éviter que les personnes présentes soient exposées.



Afin de vous assurer que votre exposition à une énergie électromagnétique de RF se situe dans les limites permises par la FCC pour une utilisation grand public, veuillez en tout temps respecter les directives suivantes:

- **NE PAS** faire fonctionner la radio sans qu'une antenne appropriée y soit fixée, car ceci risque d'endommager la radio et causer une exposition supérieure aux limites établies par la FCC. L'antenne appropriée est celle qui est fournie avec cette radio par le fabricant ou une antenne spécialement autorisée par le fabricant pour être utilisée avec cette radio.
- **NE PAS** émettre pendant plus de 50% du temps total d'utilisation de l'appareil («50% du facteur d'utilisation»). Émettre pendant plus de 50% du temps total d'utilisation peut causer une exposition aux RF supérieure aux limites établies par la FCC. La radio est en train d'émettre lorsque le témoin du mode de transmission s'affiche sur l'écran ACL. La radio émettra si vous appuyez sur le bouton du microphone.

Interférence électromagnétique et compatibilité

En mode de transmission, votre radio Icom produit de l'énergie de RF qui peut provoquer des interférences avec d'autres appareils ou systèmes. Pour éviter de telles interférences, mettez la radio hors tension dans les secteurs où une signalisation l'exige. **NE PAS** faire fonctionner l'émetteur dans des secteurs sensibles au rayonnement électromagnétique tels que les hôpitaux, les aéroports et les sites de dynamitage.

TABLE OF CONTENTS

IMPORTANT	i
EXPLICIT DEFINITIONS	i
SUPPLIED ACCESSORIES	i
PRECAUTIONS.....	ii
PRÉCAUTIONS.....	iii
SAFETY TRAINING INFORMATION.....	iv
INFORMATION EN MATIÈRE DE SÉCURITÉ.....	v
1 PANEL DESCRIPTION.....	1-2
■ Front panel.....	1
■ Function display	2
2 BASIC OPERATION.....	3-5
■ Turning ON the transceiver.....	3
■ Receiving and transmitting.....	4
■ Adjusting the squelch.....	5
3 Bluetooth® OPERATION	6-8
■ Operating Bluetooth®	6
■ Electromagnetic Interference.....	6
■ Pairing with a headset.....	7
■ Connecting a paired headset.....	7
■ Setting AF Output.....	8
■ Disconnecting a headset.....	8
■ Unpairing a headset.....	8
4 MENU MODE.....	9-10
■ Using the Menu mode	9
■ Menu item list.....	9
5 SPECIFICATIONS AND OPTIONS	11-12
■ Specifications.....	11
■ Options.....	12
5 INFORMATION	13-15
■ Firmware version identification	13
■ Disposal	13
■ Country code list	13
■ VFO channel ID list.....	14
■ FCC information.....	15
INDEX.....	16



1

PANEL DESCRIPTION

■ Front panel

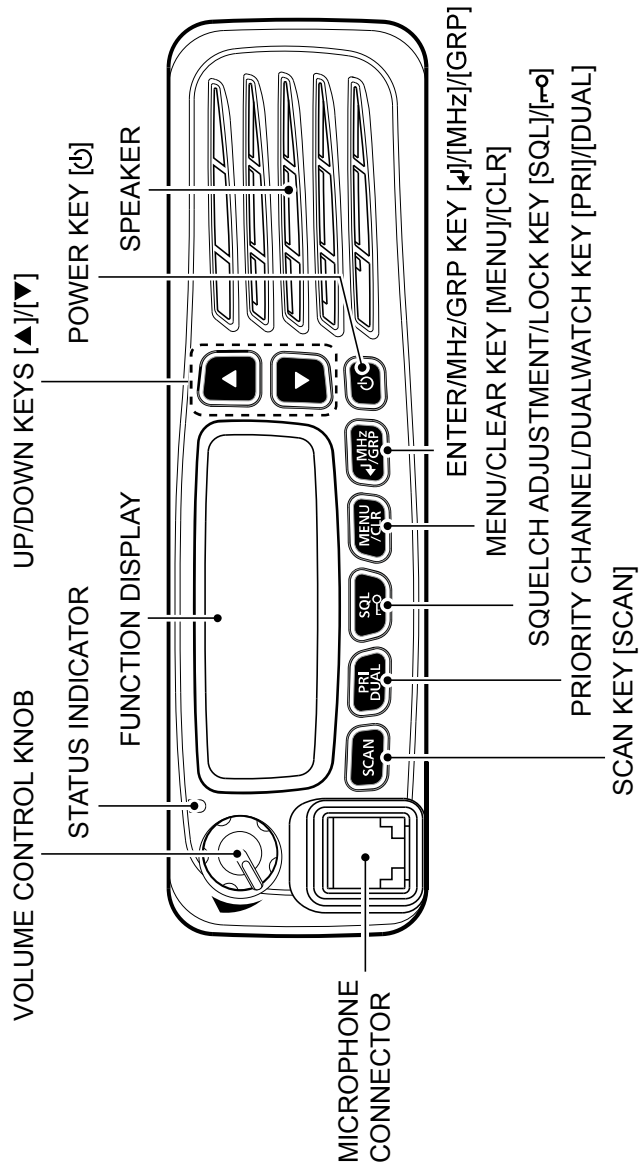

■ Function display

1

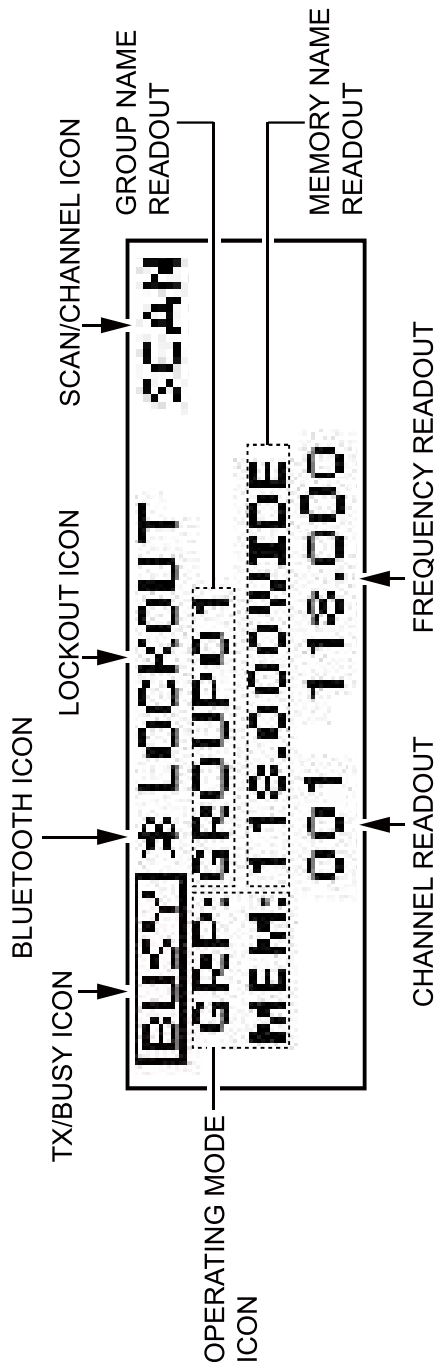



2

BASIC OPERATION

■ Turning ON the transceiver

Hold down [⏻] for 1 second to turn ON the transceiver. If the transceiver is preset for a start-up password, enter the 6 digits password.

PASSWORD

While in the Password Entry mode, "PASSWORD" is displayed.

◇ Entering the password

Enter the password in the following manner.

KEY					
NUMBER	0	1	2	3	4
	5	6	7	8	9

Example:

If the password is 513824, push [SCAN], [PRI/DUAL], [MENU/CLR], [MENU/CLR], [SQL/↔], and then push [↔/MHz/GRP].

- Note that each key represents 2 digits. That means, "123456" and "678901" are entered in exactly the same way (requires no multiple or extended pushing.)
- The entered password will not be displayed.
- If "PASSWORD" does not disappear after entering, the entered password is incorrect. Turn OFF the transceiver, and then try again.

Receiving and transmitting

1. Setting the frequency

Setting the frequency in the Memory mode

- 1) Open the "MEMORY" menu.
 - ➔ Push [↔/MHz/GRP].
 - ➔ Select "GROUPS" item.
 - ➔ Push [▲] or [▼], and then push [↔/MHz/GRP].



- 3) Select a desired group.
 - ➔ Push [▲] or [▼], and then push [↔/MHz/GRP].



- 4) Select a desired channel.
 - ➔ Push [▲] or [▼].

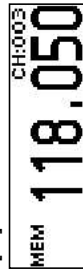

- Setting the frequency in the VFO mode (For only EXP, USA, and EUR versions.)**
- 1) Switch the transceiver to the VFO mode.
 - ➔ Select "VFO MODE" group in the Menu mode and then push [↔/MHz/GRP].

MENU > VFO MODE/MEMORY MODE

- 2) Set the MHz digit.
 - ➔ Push [↔/MHz/GRP], and then push [▲] or [▼].
 - The MHz digit blinks.
- 3) Exit the MHz Digit Selection mode.
 - ➔ Push [↔/MHz/GRP] again.
- 4) Set the kHz digit.
 - ➔ Push [▲] or [▼].

TIP: You can select the channel spacing in the "CH SPACING" item*.

MENU > SETTINGS > FUNCTIONS > CH SPACING



*The menu may not be displayed, depending on the transceiver's presets. Ask your authorized Icom dealer or transceiver administrator for details.

CAUTION: In Canada, use of 8.33 kHz Channel Spacing of this radio is strictly prohibited and shall not be used.

2 BASIC OPERATION

■ Receiving and transmitting (Continued)

2. Receiving

When receiving a signal, "BUSY" is displayed and audio is heard.

- Rotate volume control knob to adjust the audio level.
- Adjust the squelch if necessary. See 'Adjusting the squelch' to the right for details.



3. Transmitting

- 1) Hold down [PTT], and then speak at your normal voice level.
 - "TX" is displayed.

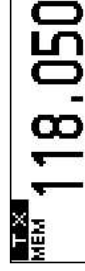

- 2) Release [PTT] to receive.

Information

To maximise the clarity of the signal, hold the microphone about 5 to 10 cm (2 to 4 inches) from your mouth.

■ Adjusting the squelch

Adjust the squelch to mute undesired noise when no signal is received.

- 1) Open the "SQL" window.
 - ↳ Push [SQL/↔].
- 2) Adjust the squelch.
 - ↳ Push [▲] or [▼] to select the desired squelch level.

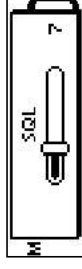

Bluetooth® OPERATION 3

■ Operating Bluetooth®

If the UT-133A Bluetooth® UNIT is installed in the transceiver, you can connect a Bluetooth® headset. When you connect the VS-3 Bluetooth® HEADSET to the transceiver, you can wirelessly transmit and receive the headset audio. The VS-3 has a [PTT] switch, so you can transmit in the same way as using the transceiver's [PTT] switch.

Communication range of Bluetooth® is approximately 10 meters (32.8 ft).

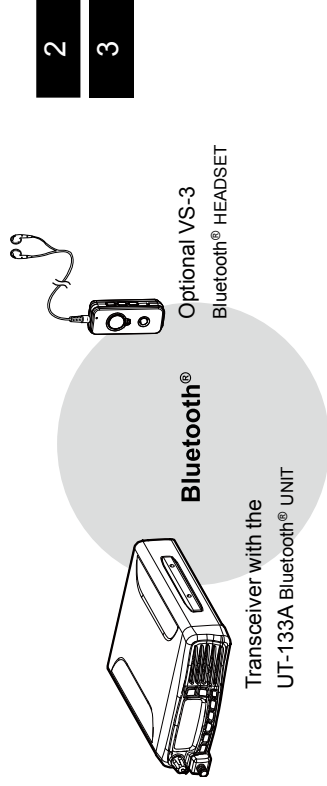

■ Electromagnetic Interference

When you use a Bluetooth® headset, pay attention to the following:

Bluetooth® devices operate in the 2.4 GHz band. The 2.4 GHz band is also used by other devices, such as Wireless LAN products, microwave ovens, RFID systems, amateur radio stations, and so on. When using the Bluetooth® headset near such devices, interference may occur, causing a decrease in communication speed, and an unstable connection. In such cases, use the headset away from the other devices, or stop using those headsets.

The Bluetooth® communication range may vary, depending on your operating environment. Microwave ovens or Wireless LANs may cause interference. In that case, stop using those devices or move away from them. This Bluetooth® headset has a usable range. If communication is unstable, move within the range.

3 Bluetooth® OPERATION

■ Pairing with a headset

These instructions describe pairing with the VS-3 Bluetooth® HEADSET. You can pair a maximum of 7 Bluetooth® headsets with the transceiver.

- If you try to pair a Bluetooth® headset to a transceiver that already has 7 headsets paired with it, the oldest headset will automatically be unpaired.

1. Turning ON transceiver's Bluetooth® function

- 1) Open the "BLUETOOTH FUNC" item.
MENU > SETTINGS > BLUETOOTH > BLUETOOTH FUNC
- 2) Activate the Bluetooth® unit.
 - ➔ Select "ON" and push [↔/MHz/GRP].

2. Entering the Pairing mode of the VS-3

- See the VS-3's instruction manual for details.

3. Pairing the Bluetooth® headset

- 1) Open the "DEVICE SEARCH" item.
MENU > BLUETOOTH > PAIR/CONNECT > DEVICE SEARCH
- 2) Search for a headset to pair.
 - ➔ Select "HEADSET" and push [↔/MHz/GRP].

- The found headsets are displayed.
- "NOT FOUND" is displayed if no headsets are found.

- Push [MENU/CLR] to cancel searching.

- The headset name changes to its Bluetooth® device address in 5 seconds.



- 3) Select the desired headset to pair.
 - ➔ Push [▲] or [▼] and then push [↔/MHz/GRP].
 - A passkey or PIN code may be required to pair, depending on the headset. Refer to your headset's instructions for details.

4) Exit the Menu mode.

- ➔ Push [0].
- "MEM" is displayed if the headset is correctly paired.

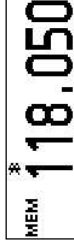

■ Connecting a paired headset

If you have a previously paired headset, follow the steps below to connect it.

- 1) Open the "PAIR/CONNECT" menu.

MENU > BLUETOOTH > PAIR/CONNECT

- The paired headsets are displayed.
- 2) Select the desired headset to connect.
 - ➔ Push [▲] or [▼] and then push [↔/MHz/GRP].
 - "CONNECT" and "UNPAIR" is displayed.

- 3) Connect the headset.
 - ➔ Select "CONNECT" and then push [↔/MHz/GRP].
 - The check mark "✓" in the box is displayed.

4) Exit the Menu mode.

- ➔ Push [0].



Setting AF Output

You can select the AF output option in the “AF OUTPUT” item.

MENU > SETTINGS > BLUETOOTH > HEADSET SET > AF OUTPUT



HEADSET:

Outputs audio to the connected Bluetooth® headset.

HEADSET & SPEAKER: Outputs audio to both the connected Bluetooth® headset and the transceiver's speaker.

Disconnecting a headset

You can disconnect from a headset without cancelling the pairing.

1) Open the “PAIR/CONNECT” menu.

MENU > BLUETOOTH > PAIR/CONNECT

- The connected headsets are displayed.
- 2) Select the desired headset to disconnect.
 - ➔ Push [▲] or [▼] and then push [↵/MHz/GRP].
 - “DISCONNECT” is displayed.

- 3) Disconnect the headset.
 - ➔ Push [↵/MHz/GRP], and then select [YES].
 - The check mark “✓” in the box disappears.
- 4) Exit the Menu mode.
 - ➔ Push [⏏].



Unpairing a headset

You can unpair a Bluetooth® headset.

Before unpairing a connected headset, disconnect it.

1) Open the “PAIR/CONNECT” menu.

MENU > BLUETOOTH > PAIR/CONNECT

- The paired headsets are displayed.
- 2) Select the desired headset to unpair.
 - ➔ Push [▲] or [▼] and then push [↵/MHz/GRP].
- 3) Unpair the headset.
 - ➔ Select “UNPAIR” and push [↵/MHz/GRP].
 - The headset name disappears from the “PAIR/CONNECT” menu.



- 4) Exit the Menu mode.
 - ➔ Push [⏏].

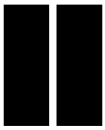

4 MENU MODE

■ Using the Menu mode

You can set seldom changed settings in the Menu mode. You can customize the transceiver settings to suit your preference and operating style.

Example: Turning OFF the key beep.

- 1) Enter the Menu mode.
➔ Push [MENU/CLR].
- 2) Open the "SETTINGS" group.
➔ Push [▲] or [▼], and then push [↵/MHz/GRP].
- 3) Open the "SOUNDS" menu.
➔ Push [▲] or [▼], and then push [↵/MHz/GRP].
- 4) Open the "KEY BEEP" item.
➔ Push [▲] or [▼], and then push [↵/MHz/GRP].
- 5) Select "OFF."
➔ Push [▲] or [▼], and then push [↵/MHz/GRP].
- 6) Exit the Menu mode.
➔ Push [⏏].

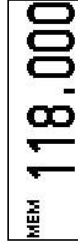

■ Menu item list

The list on this basic manual shows the transceiver's menu items.

See the FULL MANUAL for each menu item's details. You can download the FULL MANUAL from the Icom website, shown below.

<http://www.icom.co.jp/world/support/download/manual/index.php>

The menu items contained in the transceiver may be different, depending on the transceiver's setting. Ask your dealer or transceiver administrator for details.

VFO MODE/MEMORY MODE group (For only EXP, USA, and EUR versions.)
MEMORY WRITE group (May not be displayed, depending on the transceiver's settings.)
MEMORY NAME
LOCKOUT
GROUP
GROUP NAME
WRITE

MENU MODE 4

MEMORY MANAGE group*1
EDIT
MEMORY NAME
LOCKOUT
GROUP NAME
OVERWRITE
DELETE
BLUETOOTH group*2
PAIR/CONNECT
DEVICE SEARCH
PAIRING STANDBY
SETTINGS group
FUNCTIONS
CH SPACING*1
PRIORITY CH*1
NOISE LIMITING
TIME OUT TIMER*1
MIC KEY CUSTOMIZE*1
LOCK FUNCTION
CI-V*1

*1 May not be displayed, depending on the transceiver's setting.
 *2 Displayed only when the optional UT-133A Bluetooth® UNIT is installed.

SETTINGS group (Continued)
SCAN*1
SCAN TYPE*1
RESUME TIMER*1
ON-HOOK SCAN*1
STOP/TX CH*1
DISPLAY
LCD BACKLIGHT
LCD CONTRAST
INDICATION TYPE
SOUNDS
KEY BEEP
BEEP LEVEL
SIDE TONE
SPEAKER OUTPUT
BLUETOOTH*2
BLUETOOTH FUNC
AUTO CONNECT*1
HEADSET SET
DATA DEVICE SET*1
DEVICE INFO
DEVICE INITIALIZE*1
INFORMATION
VERSION



5 SPECIFICATIONS AND OPTIONS

■ Specifications

In Canada, use of 8.33 kHz Channel Spacing of this radio is strictly prohibited and shall not be used.

◇ General

- Frequency range:
 - IC-A120 118.000 to 136.99166 MHz
 - IC-A120E (AUS version) 118.000 to 136.97500 MHz
 - IC-A120E (Others) 118.000 to 136.99166 MHz
- Channel spacing: 25 kHz/8.33*1 kHz
- Type of emission:
 - IC-A120 6K00A3E/5K60A3E (FCC/EXP)
 - IC-A120E 6K00A3E (Industry Canada)
 - 6K80A3E/5K00A3E*1
- Number of memory channels: 200
- Antenna impedance: 50 Ω (nominal)
- Antenna connector: SO-239
- Power supply requirement: 13.75 V/27.5 V DC (negative ground)
- Current drain (at 13.75 V):
 - TX 5.0 A
 - Maximum audio 4.0 A
- Operating temperature range:
 - IC-A120 -30°C to +60°C, -22°F to +140°F
 - IC-A120E*2 -20°C to +55°C
- Dimensions:
 - (projections not included) 161 (W)×45 (H)×175 (D) mm,
 - 6.3 (W)×1.8 (H)×6.9 (D) inches
- Weight (approximately): 1.5 kg, 3.3 lb

*1 Except IC-A120E (AUS version).

◇ Transmitter

- Output power:
 - IC-A120 9 W (Carrier power) typical
 - IC-A120E 9 W±1.5 dB
 - (+15°C to +35°C)
 - 9 W±1.5 dB/-3dB
 - (-20°C to +55°C)
- Frequency stability:
 - IC-A120 ±5 ppm
 - IC-A120E (-30°C to +60°C, -22°F to +140°F)
 - ±1 ppm (0°C to +40°C)
- Modulation system: Last stage modulations
- Audio frequency distortion:
 - IC-A120 Less than 10%
 - IC-A120E (at 70% modulation)
 - Less than 10%
 - IC-A120E (at 85% modulation +3 dB)
- Spurious emissions:
 - IC-A120 Less than -60 dBc
 - IC-A120E*2
 - 9 kHz to 30 MHz Less than -46 dBm
 - 30 MHz to 1 GHz Less than -36 dBm (For Harmonics)
 - 1 GHz to 4 GHz Less than -46 dBm (For Non-Harmonics)

*2 Except for operating frequency ±1 MHz.

Options

◆ Receiver

- Receive system: Double conversion superheterodyne
1st 38.85 MHz
2nd 450 kHz
- Intermediate frequencies: Less than 1 μ V (pd)
(at 6 dB S/N)
Less than -101 dBm
(12 dB SINAD with CCITT)
- Sensitivity:
IC-A120 More than 0.35 μ V (pd)
IC-A120E Less than -116 dBm
More than 5 mV (pd)
More than 70 dB
- Squelch sensitivity:
IC-A120 More than 10 W
IC-A120E (at 13.75 V DC with 8 Ω load 60% mod, 10% distortion)
- Spurious response rejection ratio: More than 100 mW
IC-A120 (at 13.75 V DC with 500 Ω load 60% mod, 10% distortion)
- Audio output power: More than 100 mW
IC-A120E (at 13.75 V DC with 500 Ω load 60% mod, 10% distortion)
- External speaker: More than 10 W
(at 13.75 V DC with 8 Ω load 60% mod, 10% distortion)
- Side tone: More than 100 mW
(at 13.75 V DC with 500 Ω load 60% mod, 10% distortion)

All stated specifications are subject to change without notice or obligation.

HM-217 SPEAKER MICROPHONE
The speaker microphone with [▲]/[▼] keys and [P1]/[P2] keys.

VS-3 Bluetooth® HEADSET
The Bluetooth® headset with a [PTT] switch.

UT-133A Bluetooth® UNIT

OPC-871A HEADSET ADAPTER
The adapter to connect a standard headset.

OPC-478UC CLONING CABLE
The cable to connect a PC and the OPC-592 CLONING CABLE ADAPTER when you control the transceiver with the CI-V commands.

OPC-592 CLONING CABLE ADAPTER
The cable adapter to connect the transceiver and the OPC-478UC CLONING CABLE when you control the transceiver with the CI-V commands.

Approved Icom optional equipment is designed for optimal performance when used with an Icom transceiver. Icom is not responsible for the destruction or damage to an Icom transceiver in the event the Icom transceiver is used with equipment that is not manufactured or approved by Icom.

6 INFORMATION

■ Firmware version identification

You can identify your transceiver's firmware version in the "VERSION" menu.

MENU > SETTINGS > INFORMATION > VERSION



■ Disposal

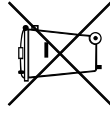

The crossed-out wheeled-bin symbol on your product, literature, or packaging reminds you that in the European Union, all electrical and electronic products, batteries, and accumulators (rechargeable batteries) must be taken to

designated collection locations at the end of their working life. Do not dispose of these products as unsorted municipal waste. Dispose of them according to the laws in your area.

■ Country code list

• ISO 3166-1

	Country	Codes	Country	Codes
1	Austria	AT	Liechtenstein	LI
2	Belgium	BE	Lithuania	LT
3	Bulgaria	BG	Luxembourg	LU
4	Croatia	HR	Malta	MT
5	Czech Republic	CZ	Netherlands	NL
6	Cyprus	CY	Norway	NO
7	Denmark	DK	Poland	PL
8	Estonia	EE	Portugal	PT
9	Finland	FI	Romania	RO
10	France	FR	Slovakia	SK
11	Germany	DE	Slovenia	SI
12	Greece	GR	Spain	ES
13	Hungary	HU	Sweden	SE
14	Iceland	IS	Switzerland	CH
15	Ireland	IE	Turkey	TR
16	Italy	IT	United Kingdom	GB
17	Latvia	LV		

■ VFO channel ID list

(For only EXP, USA, and EUR versions.)

- Channel spacing: 25 kHz (Actual frequency is displayed.)

Operating Frequency (MHz)	Channel spacing (kHz)	Channel ID (Displayed Frequency)
118.0000	25	118.000
118.0250	25	118.025
118.0500	25	118.050
118.0750	25	118.075
118.1000	25	118.100

- Channel spacing: 8.33 kHz

Operating Frequency (MHz)	Channel spacing (kHz)	Channel ID (Displayed Frequency)
118.0000	8.33	118.005
118.0083	8.33	118.010
118.0167	8.33	118.015
118.0250	8.33	118.030
118.0333	8.33	118.035
118.0417	8.33	118.040
118.0500	8.33	118.055
118.0583	8.33	118.060
118.0667	8.33	118.065
118.0750	8.33	118.080
118.0833	8.33	118.085
118.0917	8.33	118.090
118.1000	8.33	118.105

CAUTION: In Canada, use of 8.33 kHz Channel Spacing of this radio is strictly prohibited and shall not be used.

These tables show just the display example between 118.0000 MHz and 118.1000 MHz. Not all frequencies in the band are shown.

6 INFORMATION

■ FCC information

• **FOR CLASS A UNINTENTIONAL RADIATORS:** This equipment has been tested and found to comply with the limits for a Class A digital device, pursuant to part 15 of the FCC Rules. These limits are designed to provide reasonable protection against harmful interference when the equipment is operated in a commercial environment. This equipment generates, uses, and can radiate radio frequency energy and, if not installed and used in accordance with the instruction manual, may cause harmful interference to radio communications. Operation of this equipment in a residential area is likely to cause harmful interference in which case the user will be required to correct the interference at his own expense.

• **POUR LES RAYONNEMENTS NON INTENTIONNELS DE CLASSE A:**

Cet équipement a été testé et reconnu conforme aux limites fixées pour un appareil numérique de classe A, conformément au point 15 de la réglementation FCC. Ces limites sont définies de façon à fournir une protection raisonnable contre le brouillage préjudiciable lorsque cet appareil est utilisé dans un environnement commercial. Cet équipement génère, utilise et peut émettre un rayonnement de fréquence radio. S'il n'a pas été installé conformément aux instructions, il peut par ailleurs créer des interférences perturbant les communications radio. L'utilisation de cet appareil dans une zone résidentielle peut provoquer un brouillage préjudiciable, auquel cas l'utilisateur sera tenu de corriger la situation à ses frais.

INDEX

A		
AF Output.....	7	
B		
Basic operation.....	3	
Bluetooth® operation.....	6	
D		
Disposal.....	13	
E		
Electromagnetic Interference.....	6	
F		
FCC information.....	15	
Firmware version identification.....	13	
Front panel.....	1	
Function display.....	2	
H		
Headset		
Connecting a paired headset.....	7	
Disconnecting from a headset.....	8	
Pairing with a headset.....	7	
Unpairing a headset.....	8	
I		
Important.....	i	
M		
Menu item list.....	9	
Menu mode.....	9	
O		
Options.....	12	
P		
Panel Description.....	1	
Precautions.....	ii	
R		
Receiving.....	4	
S		
Safety training information.....	iv	
Specifications.....	11	
Squelch.....	5	
T		
Transmitting.....	4	
Turning ON the transceiver.....	3	
V		
VFO channel ID list.....	14	

Count on us!



< Intended Country of Use >

- AT
- BE
- CY
- CZ
- DK
- EE
- FI
- FR
- DE
- GR
- HU
- IE
- IT
- LV
- LT
- LU
- MT
- NL
- PL
- PT
- SK
- SI
- ES
- SE
- GB
- IS
- LI
- NO
- CH
- BG
- RO
- TR
- HR

A-7249D-1EX-②

Printed in Japan

© 2015–2016 Icom Inc.

Printed on recycled paper with soy ink.

Icom Inc.

1-1-32 Kamiminami, Hirano-ku, Osaka 547-0003, Japan