

THEA Satellite

Exhibit 2

File #: 0176-EX-CN-2018

Technical Information

February 27, 2018
May 9, 2018 (Rev A)
August 16, 2018 (Rev B)

Submitted By

SpaceQuest, Ltd.
3554 Chain Bridge Road
Suite 400
Fairfax, VA 22030

Table of Contents

1	Ownership, Operations and Construction	3
2	Orbital Requirements	3
3	Service Area	3
4	Satellite Payload	3
5	Principle Specifications	4
6	System Block Diagram	4
7	Telemetry, Tracking & Command and Payload Operations	5
8	Radio Equipment	6
8.1	UHF Transceiver	6
8.1.1	Downlink: UHF Transmit	6
8.1.2	Uplink: UHF Receive.....	6
8.2	S-Band Transceiver:	6
8.2.1	Downlink: S-Band Transmit.....	6
8.2.2	Uplink: S-Band Receive	6
8.3	Wideband Receiver:	7
9	Antenna Systems	7
10	Satellite Link Budgets	8
11	Interference Analysis	11
11.1	400.50-400.65 MHz (TT&C Downlink)	11
11.2	399.90 -400.05 MHz (TT&C Uplink)	11
11.3	2200-2202MHz (Payload Downlink).....	11
11.4	2045-2046 MHz (Payload Uplink).....	11
12	Power Flux Density Analysis	12
12.1	400.50-400.65 MHz (TT&C Downlink)	12
12.2	2200-2202 MHz (Payload Downlink)	12
13	Space Station Antenna Radiation Patterns	13
13.1	S-Band: THEA Space Station Transmit/Receive Antenna	13
13.2	UHF: THEA Space Station Transmit/Receive Antenna	13
13.3	Broadband: THEA Space Station Receive Antenna.....	14
13.4	Summary of THEA Antenna Characteristics	14
14	Earth Station Antenna Radiation Patterns	15
14.1	UHF Antennas in Fairfax, VA, North Pole, AK and Naalehu, HI and Limestone, ME	15
14.2	S-Band Earth Station Antenna in North Pole Alaska and Limestone, Maine	16
15	Stop Buzzer POC	16

List of Figures

Figure 1 Orbital Parameters.....	3
Figure 2 System Block Diagram.....	4
Figure 3 Isometric view of deployed configuration	5
Figure 4 Summary of THEA Transmitter and Receiver parameters.....	7
Figure 5 Antenna Frequency Registration	7
Figure 6 Frequency Emissions Registration	8
Figure 7 Satellite UHF Uplink Budget.....	8
Figure 8 Satellite UHF Downlink Budget.....	9
Figure 9 Satellite S-Band Uplink Budget	9
Figure 10 Satellite S-Band Downlink Budget	10
Figure 13 Satellite UHF Link Margins Vs. Elevation Angle	10
Figure 14 Satellite S-Band Link Margins Vs. Elevation Angle.....	10
Figure 15 PFD at the Surface of the Earth for the UHF Transmitter Downlink	12
Figure 16 PFD at the Surface of the Earth for the S-Band Transmitter Downlink	12
Figure 17 S-Band Satellite Transmit/Receive Antenna Radiation Pattern	13
Figure 18 UHF Satellite Transmit/Receive Antenna Radiation Pattern.....	13
Figure 20 Flexitech Broadband Receive Antenna and Radiation Pattern.	14
Figure 21 THEA Antenna Characteristics	15
Figure 22 UHF Earth Station Antenna Radiation Pattern.	15
Figure 24 S-Band Earth Station Antenna Radiation Pattern.....	16

1 Ownership, Operations and Construction.

SpaceQuest, Ltd. is a small business concern, and the owner, manufacturer and operator of the THEA satellite. SpaceQuest has selected Spaceflight Industries of Seattle, Washington as the launch provider. THEA will be launched on a SpaceX Falcon 9 launch vehicle from Vandenberg, AFB in California (geographic coordinates 34.5762°N; 4.2803°W) in November 2018. Pursuant to Part 5 §5.64 of the Commission’s Rules, construction of the proposed experimental satellite and associated facilities has begun prior to the Commission’s grant of an authorization. This is necessary given the nature of satellite construction and technical requirements over long lead times. Such construction is entirely at SpaceQuest’s risk without any assurances that its proposed experiment will be subsequently approved.

- Space Station Name: THEA
- THEA Estimated Construction Completion Date: August 2018
- Spaceflight Final Certification of Licenses (Go/NoGo): September 12, 2018
- Purpose: Experimental, non-Common Carrier basis
- Orbital Type: NGSO

2 Orbital Requirements.

The satellite is designed to operate in a circular sun-synchronous orbit as described in Figure 1. The satellites are based on COTS technology that allows for small, lightweight and low-cost spacecraft.

THEA	Value
Total Number of Orbital Planes:	1
Celestial Reference Body:	Earth
Inclination Angle (degrees):	97.52
Orbital Period (seconds)	5760
LTAN	22:30
Apogee	575 km
Perigee	575 km

Figure 1 Orbital Parameters

3 Service Area.

Worldwide

4 Satellite Payload.

The primary satellite mission of THEA is to test an experimental spectrum survey payload developed by Aurora Insight, a US company. The Aurora payload is an experiment to demonstrate and validate the ability of its flight computer firmware to monitor, process and generate relevant measurements of the spectral environment in the 1.35 to 8.0 GHz

band using a novel wideband antenna developed by Flexitech Aerospace. The THEA UHF frequency assignment will be used for satellite telemetry, command and control. The S-Band assignment will be used to download selected mission data from the Aurora payload and upload new computer firmware to improve performance and correct any software deficiencies.

5 Principle Specifications.

THEA is a 3U CubeSat whose outside envelope measures 100 x 100 x 340.5mm. The satellite's total mass is less than 5 kg. It has four deployable solar arrays, which will deploy from the short edges of the spacecraft. The Lilon battery consists of eight cells wired as 4-series and 2 parallel. The expected mission lifetime of the satellite is 5 years in a 575-km orbit due to battery life and deorbit analysis. SpaceQuest will own and operate the experimental CubeSat throughout its mission lifetime. The THEA satellite will never be sold or transferred to another party.

6 System Block Diagram.

Figure 2 below shows the major components of the spacecraft and their interfaces. The flight computer is responsible for TT&C and payload scheduling. The attitude determination and control system orients the solar panels to the sun, except when the satellite is re-oriented to communicate with a ground station. Two Software Defined Radios are shown below, one is for an S-Band transceiver and the other is for the Aurora experimental wideband receiver. The deployed array and antenna configuration is shown in Figure 3.

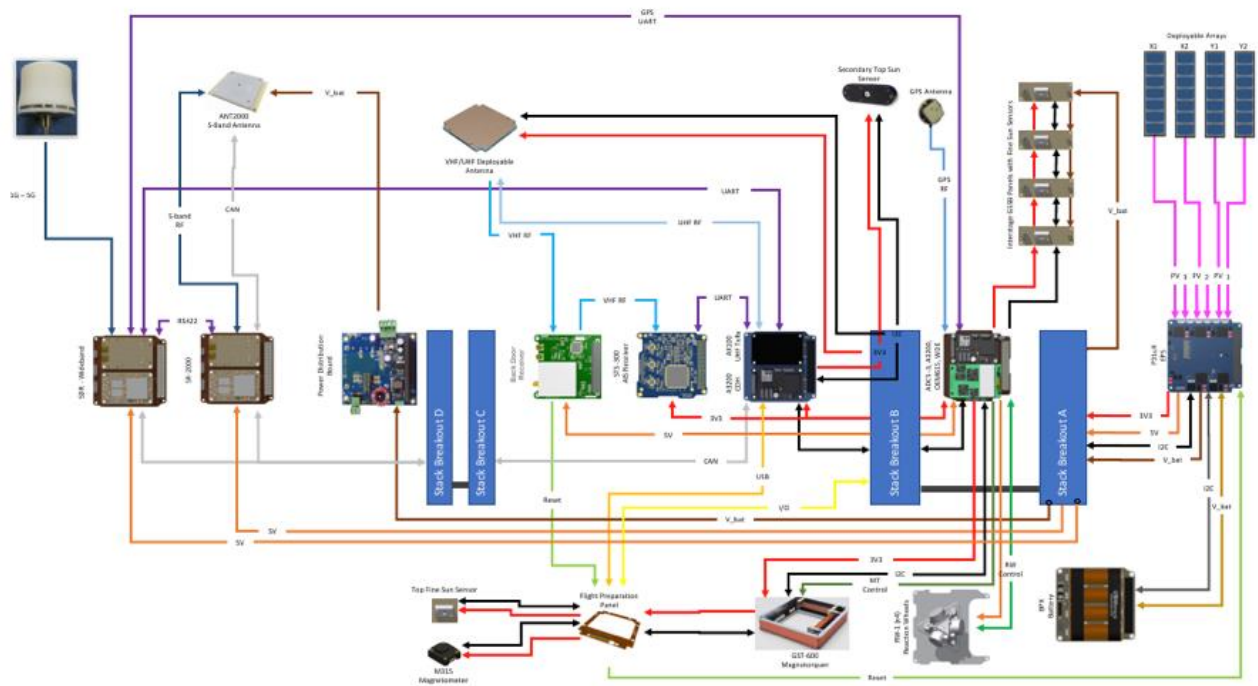

Figure 2 System Block Diagram

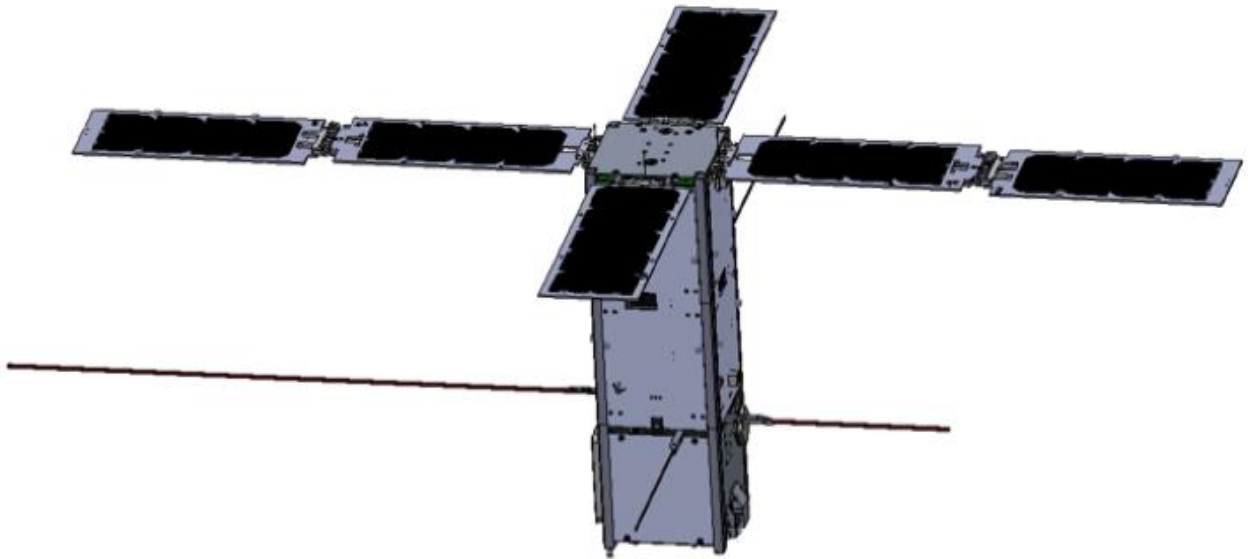

Figure 3 Isometric view of deployed configuration

This configuration allows for two VHF and two UHF monopole antennas deployed from the body of the spacecraft. One UHF antenna is used for TT&C communication. The second UHF antenna is grounded.

7 Telemetry, Tracking & Command and Payload Operations

The space-to-Earth downlink frequency band of 400.50-400.65 MHz and the Earth-to-space uplink frequency band of 399.90-400.05 MHz for TT&C communications will communicate with SpaceQuest's Earth stations in Fairfax, Virginia, Naalehu, Hawaii, North Pole, Alaska, and Limestone, Maine. The SpaceQuest TT&C Earth stations will also have the capability to uplink executive commands to the backdoor command receiver at 145.92 MHz.

The space-to-Earth frequency band of 2200-2202 MHz will be used to downlink experimental test data to Earth Stations in Limestone, Maine and Esrange, Sweden. The Earth-to-space uplink frequency band of 2045-2046 MHz from Limestone, Maine and Esrange, Sweden will be used occasionally to upload new firmware to the THEA payload.

8 Radio Equipment.

8.1 UHF Transceiver

- NanoComm A-100 UHF Transceiver manufactured by GomSpace.
- Primary transceiver capability for telecommand, telemetry, and schedule uploads.
- The transceiver can operate between 390 and 406 MHz at 9600 bps. modulation.

8.1.1 Downlink: UHF Transmit

- Operating Frequency 400.60 MHz
- Output Power: 3 Watts
- EIRP: 3.3 dBW
- Channels: 400.50-400.65 MHz
- Frequency Deviation: 16 kHz

8.1.2 Uplink: UHF Receive

- Operating Frequency 399.95 MHz
- Sensitivity: -110 dBm
- Channels: 399.90-400.05 MHz
- Frequency Stability: ± 10 ppm.

8.2 S-Band Transceiver:

- GomSpace TR600 S-Band SDR Transceiver
- Primary transceiver for mission data and commands to primary payload.
- Space-to-Earth downlink operates from 2200 to 2202MHz
- Earth-to-space uplink operated from 2045 to 2046 MHz
- QPSK modulation.

8.2.1 Downlink: S-Band Transmit

- Requested Frequency Band: 1MHz in the 2200-2202 MHz band
- Output Power: 1 Watts
- Peak antenna Gain: 7 dBi
- EIRP: 3.3 dBW
- Data Rate: 1,500 kbps
- Channels: Tunable SDR Transmitter from 2200-2290 MHz
- Necessary Bandwidth: 2,000 kHz.

8.2.2 Uplink: S-Band Receive

- Operating Frequency: 1MHz in the 2045-2046 MHz band
- Sensitivity: -100 dBm
- Data Rate: 700 kbps
- Channels: Tunable SDR Receiver from 2025-2110 MHz
- Frequency Stability: ± 10 ppm

8.3 Wideband Receiver:

- Aurora RADS-200 (Reconfigurable Advanced Digital Sensor)
- Uses broadband receive antenna manufactured by Flexitech Aerospace
- Operating frequency: 1.35-7.075 GHz
- Maximum instantaneous bandwidth: 56 MHz
- Sensitivity: -110 dBm

A summary of the THEA Transmitter and Receiver parameters are provided in Figure 4.

Description	Transmitter 1	Transmitter 2	Receiver 1	Receiver 2	Receiver 3
Radio Name	UTX	SBTX	URX	SBRX	WBRX
Carrier Frequency, MHz	400.6	2201	399.95	2045.5	NA
3 dB Bandwidth, MHz	0.015	1.5	0.015	0.75	NA
Necessary Bandwidth, MHz	0.035	2.0	0.035	1.0	NA
20 dB Bandwidth, MHz	0.020	1.75	NA	NA	NA
60 dB Bandwidth, MHz	0.035	2.0	NA	NA	NA
Receiver Sensitivity, dBm	NA	NA	-110	-100	-110
Antenna Gain, dBi	0.0	7.0	0.0	7.0	3.0
Modulation Type	GMSK	QPSK	GMSK	QPSK	NA
Total Data Rate (KHz)	9.6	1500	9.6	700	NA
Receiver Span (MHz)	NA	NA	0.15	1.0	5.725
EIRP, dBW	3.3	3.4	NA	NA	NA
Antenna Polarization	Linear	Circular	Linear	Circular	Circular

Figure 4 Summary of THEA Transmitter and Receiver parameters.

9 Antenna Systems

The transmit antenna parameters for the THEA Satellite are provided in Figure 5 and Figure 6.

Lower Frequency	Upper Frequency	Freq. Units	Power	Power Units	Output Power/ERP	ERP Units	Mean/Peak	Frequency Tolerance	Station Class
2200	2202	MHz	1.0	W	3.4	dBW	Peak	+/-10 ppm	Mobile
400.50	400.65	MHz	3.0	W	3.3	dBW	Peak	+/-10 ppm	Mobile

Figure 5 Antenna Frequency Registration

Lower Frequency	Upper Frequency	Units	Emission	Modulating Signal	Necessary Bandwidth
2200	2202	MHz	2M00G1D	QPSK	2,000 KHz
400.50	400.65	MHz	25K0F1D	GMSK	35KHz

Figure 6 Frequency Emissions Registration

10 Satellite Link Budgets

The UHF uplink budget is shown in Figure 7. Figure 8 shows the UHF downlink budget.

UHF		Uplink Budget							2/26/18	
ELEVATION ANGLE TO SATELLITE (Deg)		5	10	20	30	45	60	75	90	
ORBITAL ALTITUDE (km)		575	575	575	575	575	575	575	575	
EARTH'S RADIUS (km)		6378	6378	6378	6378	6378	6378	6378	6378	
COVERAGE HALF ANGLE TO HORIZON (Deg)		67	67	67	67	67	67	67	67	
SLANT RANGE TO SATELLITE (km)		2268	1874	1343	1034	782	655	594	575	
SURFACE DISTANCE FROM RECEIVER TO SSP (km)		2111	1714	1164	824	508	301	141	0	
Ground Transmitter										
TRANSMITTER FREQUENCY (MHz)		399.95	399.95	399.95	399.95	399.95	399.95	399.95	399.95	
GROUND TRANSMITTER POWER (Watts)		10.0	10.0	10.0	10.0	10.0	10.0	10.0	10.0	
GROUND TRANSMITTER POWER (dB)		10.0	10.0	10.0	10.0	10.0	10.0	10.0	10.0	
TRANSMISSION LINE LOSS (dB)		1.5	1.5	1.5	1.5	1.5	1.5	1.5	1.5	
ANTENNA GAIN (dBi)		13.5	13.5	13.5	13.5	13.5	13.5	13.5	13.5	
GROUND TRANSMITTER EIRP (dBw)		22.0	22.0	22.0	22.0	22.0	22.0	22.0	22.0	
Satellite Receiver										
FREE SPACE LOSS (dB)		151.6	149.9	147.0	144.7	142.3	140.8	139.9	139.6	
ISOTROPIC POWER AT SATELLITE ANTENNA (dB)		-129.6	-127.9	-125.0	-122.7	-120.3	-118.8	-117.9	-117.6	
SATELLITE RECEIVER ANTENNA GAIN (dBi)		0.0	0.0	0.0	0.0	0.0	0.0	0.0	0.0	
POLARIZATION LOSS (dB)		3.0	3.0	3.0	3.0	3.0	3.0	3.0	3.0	
IMPLEMENTATION LOSS (dB)		1.0	1.0	1.0	1.0	1.0	1.0	1.0	1.0	
SYSTEM NOISE TEMPERATURE (K)		400	400	400	400	400	400	400	400	
FRONT END GAIN (Ant Gain-Losses) (dB)		-4.0	-4.0	-4.0	-4.0	-4.0	-4.0	-4.0	-4.0	
FRONT END G/T (dB/K)		-30.0	-30.0	-30.0	-30.0	-30.0	-30.0	-30.0	-30.0	
BOLTZMAN'S CONSTANT (dB)		-228.6	-228.6	-228.6	-228.6	-228.6	-228.6	-228.6	-228.6	
UPLINK C/No (dB-Hz)		69.0	70.7	73.6	75.8	78.3	79.8	80.7	80.9	
DATA RATE (bps)		9600	9600	9600	9600	9600	9600	9600	9600	
Eb/No (dB)		29.2	30.9	33.8	36.0	38.5	40.0	40.8	41.1	
Eb/No REQUIRED FOR BER OF 10 ⁻⁵ (dB)		11.5	11.5	11.5	11.5	11.5	11.5	11.5	11.5	
UPLINK MARGIN (dB)		17.7	19.4	22.3	24.5	27.0	28.5	29.3	29.6	

Figure 7 Satellite UHF Uplink Budget

UHF		Downlink Budget							2/26/18	
ELEVATION ANGLE TO SATELLITE (Deg)		5	10	20	30	45	60	75	90	
ORBITAL ALTITUDE (km)		575	575	575	575	575	575	575	575	
EARTH'S RADIUS (km)		6378	6378	6378	6378	6378	6378	6378	6378	
COVERAGE HALF ANGLE TO HORIZON (Deg)		67	67	67	67	67	67	67	67	
SLANT RANGE TO SATELLITE (Km)		2268	1874	1343	1034	782	655	594	575	
SURFACE DISTANCE FROM RECEIVER TO SSP (km)		2111	1714	1164	824	508	301	141	0	
Satellite Transmitter										
SATELLITE DOWNLINK FREQUENCY (MHz)		400.60	400.60	400.60	400.60	400.60	400.60	400.60	400.60	
TRANSMITTER OUTPUT POWER (Watts)		3.0	3.0	3.0	3.0	3.0	3.0	3.0	3.0	
TRANSMITTER OUTPUT POWER (dBw)		4.8	4.8	4.8	4.8	4.8	4.8	4.8	4.8	
IMPLEMENTATION LOSS (dB)		1.5	1.5	1.5	1.5	1.5	1.5	1.5	1.5	
SATELLITE TRANSMIT ANTENNA GAIN (dB)		0.0	0.0	0.0	0.0	0.0	0.0	0.0	0.0	
SATELLITE DOWNLINK EIRP (Watts)		2.1	2.1	2.1	2.1	2.1	2.1	2.1	2.1	
SATELLITE DOWNLINK EIRP (dBw)		3.3	3.3	3.3	3.3	3.3	3.3	3.3	3.3	
Ground Receiver										
FREE SPACE LOSS (dB)		151.6	149.9	147.0	144.7	142.3	140.8	139.9	139.6	
ISOTROPIC POWER AT MOBILE ANTENNA (dBw)		-148.3	-146.6	-143.7	-141.5	-139.0	-137.5	-136.7	-136.4	
GROUND ANTENNA GAIN (dB)		13.5	13.5	13.5	13.5	13.5	13.5	13.5	13.5	
POLARIZATION LOSS (dB)		3.0	3.0	3.0	3.0	3.0	3.0	3.0	3.0	
TRANSMISSION LINE LOSS (dB)		1.0	1.0	1.0	1.0	1.0	1.0	1.0	1.0	
SYSTEM NOISE TEMPERATURE (K)		290	290	290	290	290	290	290	290	
FRONT END GAIN (Ant Gain-Losses) (dB)		9.5	9.5	9.5	9.5	9.5	9.5	9.5	9.5	
FRONT END G/T (dB/K)		-15.1	-15.1	-15.1	-15.1	-15.1	-15.1	-15.1	-15.1	
BOLTZMAN'S CONSTANT (dB)		-228.6	-228.6	-228.6	-228.6	-228.6	-228.6	-228.6	-228.6	
DOWNLINK C/No (dB-Hz)		65.2	66.8	69.7	72.0	74.4	76.0	76.8	77.1	
DATA RATE (bps)		9600	9600	9600	9600	9600	9600	9600	9600	
Eb/No (dB)		25.4	27.0	29.9	32.2	34.6	36.1	37.0	37.3	
Eb/No REQUIRED FOR GMSK BER of 10 ⁻⁵ (dB)		11.5	11.5	11.5	11.5	11.5	11.5	11.5	11.5	
DOWNLINK MARGIN (dB)		13.9	15.5	18.4	20.7	23.1	24.6	25.5	25.8	

Figure 8 Satellite UHF Downlink Budget

The S-Band uplink budget is shown in Figure 9. Figure 10 shows the UHF downlink budget.

S-Band		Uplink Budget							2/26/18
ELEVATION ANGLE TO SATELLITE (Deg)	1	5	15	25	40	60	75	90	
ORBITAL ALTITUDE (km)	575	575	575	575	575	575	575	575	
EARTH'S RADIUS (km)	6378	6378	6378	6378	6378	6378	6378	6378	
COVERAGE HALF ANGLE TO HORIZON (Deg)	67	67	67	67	67	67	67	67	
SLANT RANGE TO SATELLITE (km)	2660	2268	1573	1169	847	655	594	575	
SURFACE DISTANCE FROM RECEIVER to SSP (km)	2503	2111	1405	975	596	301	141	0	
		0.0							
Ground Transmitter		0							
TRANSMITTER FREQUENCY (MHz)	2045.5	2045.5	2045.5	2045.5	2045.5	2045.5	2045.5	2045.5	
GROUND TRANSMITTER POWER (Watts)	10	10	10	10	10	10	10	10	
GROUND TRANSMITTER POWER (dB)	10.0	10.0	10.0	10.0	10.0	10.0	10.0	10.0	
TRANSMISSION LINE LOSS (dB)	1.5	1.5	1.5	1.5	1.5	1.5	1.5	1.5	
ANTENNA GAIN (dBi) (10-foot dish at 50% efficiency)	40.0	40.0	40.0	40.0	40.0	40.0	40.0	40.0	
GROUND TRANSMITTER EIRP (dBw)	48.5	48.5	48.5	48.5	48.5	48.5	48.5	48.5	
Satellite Receiver									
FREE SPACE LOSS (dB)	167.1	165.7	162.5	160.0	157.2	154.9	154.1	153.8	
ISOTROPIC POWER AT SATELLITE ANTENNA (dB)	-119	-117	-114	-111	-109	-106	-106	-105	
SATELLITE RECEIVER ANTENNA GAIN (dBi)	3.0	3.0	3.0	3.0	3.0	3.0	3.0	3.0	
POLARIZATION LOSS (dB)	3.0	3.0	3.0	3.0	3.0	3.0	3.0	3.0	
IMPLEMENTATION LOSS (dB)	1.5	1.5	0.5	0.5	0.5	0.5	0.5	0.5	
SYSTEM NOISE TEMPERATURE (K)	400	400	400	400	400	400	400	400	
FRONT END GAIN (Ant Gain-Losses) (dB)	-1.5	-1.5	-0.5	-0.5	-0.5	-0.5	-0.5	-0.5	
FRONT END G/T (dB/K)	-27.5	-27.5	-26.5	-26.5	-26.5	-26.5	-26.5	-26.5	
BOLTZMAN'S CONSTANT (dB)	-228.6	-228.6	-228.6	-228.6	-228.6	-228.6	-228.6	-228.6	
UPLINK C/No (dB-Hz)	82.5	83.9	88.0	90.6	93.4	95.6	96.5	96.8	
DATA RATE (bps)	700000	700000	700000	700000	700000	700000	700000	700000	
Eb/No (dB)	24.0	25.4	29.6	32.2	35.0	37.2	38.0	38.3	
Eb/No REQUIRED FOR BER OF 10 ⁻⁶ (dB) (GMSK)	13.0	13.0	13.0	13.0	13.0	13.0	13.0	13.0	
UPLINK MARGIN (dB)	11.0	12.4	16.6	19.2	22.0	24.2	25.0	25.3	

Figure 9 Satellite S-Band Uplink Budget

S-Band		Downlink Budget							8/16/18
ELEVATION ANGLE TO SATELLITE (Deg)	1	5	15	25	40	60	75	90	
ORBITAL ALTITUDE (km)	575	575	575	575	575	575	575	575	
EARTH'S RADIUS (km)	6378	6378	6378	6378	6378	6378	6378	6378	
COVERAGE HALF ANGLE TO HORIZON (Deg)	67	67	67	67	67	67	67	67	
SLANT RANGE TO SATELLITE (Km)	2660	2268	1573	1169	847	655	594	575	
SURFACE DISTANCE to SSP (km)	2503	2111	1405	975	596	301	141	0	
Satellite Transmitter									
SATELLITE DOWNLINK FREQUENCY (MHz)	2201.0	2201.0	2201.0	2201.0	2201.0	2201.0	2201.0	2201.0	
TRANSMITTER OUTPUT POWER (Watts)	1.0	1.0	1.0	1.0	1.0	1.0	1.0	1.0	
TRANSMITTER OUTPUT POWER (dBw)	0.0	0.0	0.0	0.0	0.0	0.0	0.0	0.0	
TRANSMISSION LINE LOSS	1.6	1.6	1.6	1.6	1.6	1.6	1.6	1.6	
IMPLEMENTATION LOSS (dB)	2.0	2.0	2.0	2.0	2.0	2.0	2.0	2.0	
SATELLITE TRANSMIT ANTENNA GAIN (dB)	7.0	7.0	7.0	7.0	7.0	7.0	7.0	7.0	
SATELLITE DOWNLINK EIRP (Watts)	2.2	2.2	2.2	2.2	2.2	2.2	2.2	2.2	
SATELLITE DOWNLINK EIRP (dBw)	3.4	3.4	3.4	3.4	3.4	3.4	3.4	3.4	
Ground Receiver									
FREE SPACE LOSS (dB)	167.7	166.4	163.2	160.6	157.8	155.6	154.7	154.4	
ISOTROPIC POWER AT MOBILE ANTENNA (dBw)	-164.3	-163.0	-159.8	-157.2	-154.4	-152.2	-151.3	-151.0	
GROUND ANTENNA GAIN (dB)	40.0	40.0	40.0	40.0	40.0	40.0	40.0	40.0	
POLARIZATION LOSS (dB)	3.0	3.0	3.0	3.0	3.0	3.0	3.0	3.0	
TRANSMISSION LINE LOSS (dB)	1.5	1.5	1.5	1.5	1.5	1.5	1.5	1.5	
SYSTEM NOISE TEMPERATURE (K)	290	290	290	290	290	290	290	290	
FRONT END GAIN (Ant Gain-Losses) (dB)	35.5	35.5	35.5	35.5	35.5	35.5	35.5	35.5	
FRONT END G/T (dB/K)	10.9	10.9	10.9	10.9	10.9	10.9	10.9	10.9	
BOLTZMAN'S CONSTANT (dB)	-228.6	-228.6	-228.6	-228.6	-228.6	-228.6	-228.6	-228.6	
DOWNLINK C/No (dB-Hz)	75.1	76.5	79.7	82.3	85.1	87.3	88.2	88.4	
DATA RATE (bps)	700000	700000	700000	700000	700000	700000	700000	700000	
Eb/No (dB)	16.7	18.1	21.2	23.8	26.6	28.8	29.7	30.0	
Eb/No REQUIRED FOR GMSK BER of 10 ⁻⁶ (dB)	13.0	13.0	13.0	13.0	13.0	13.0	13.0	13.0	
DOWNLINK MARGIN (dB)	3.7	5.1	8.2	10.8	13.6	15.8	16.7	17.0	

Figure 10 Satellite S-Band Downlink Budget

The satellite link margins for the UHF and S-Band radios are plotted in Figure 11 and Figure 12.

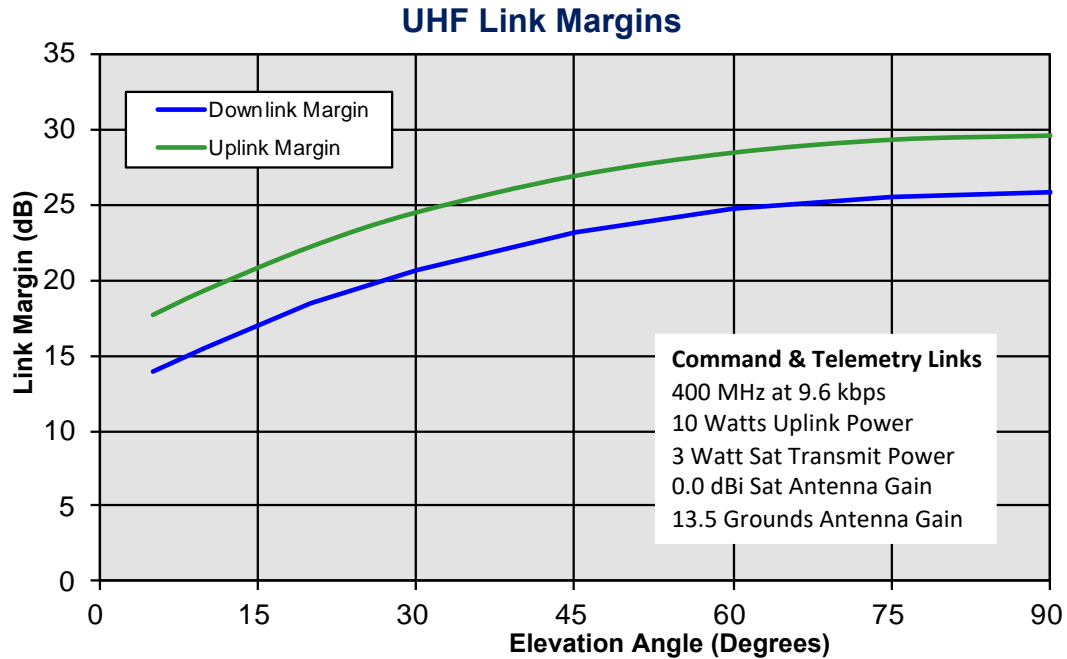

Figure 11 Satellite UHF Link Margins Vs. Elevation Angle

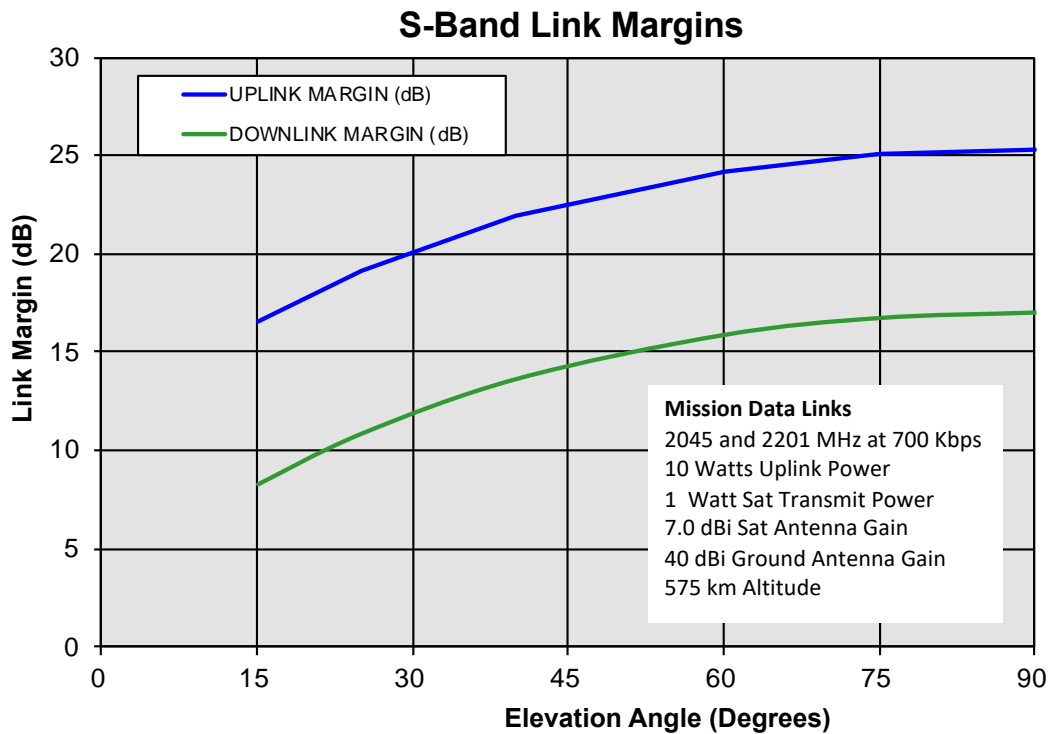

Figure 12 Satellite S-Band Link Margins Vs. Elevation Angle

11 Interference Analysis

11.1 400.50-400.65 MHz (TT&C Downlink).

Interference with U.S. federal and commercial assignments in the 400.50-400.65 MHz band is unlikely as transmissions will only occur while over the SpaceQuest TT&C ground stations. The 400.50 to 400.65 MHz space-to-Earth band is allocated for UHF Little LEO data services and has been used experimentally by SpaceQuest for the past 5 years

11.2 399.90 -400.05 MHz (TT&C Uplink)

Interference with U.S. federal and commercial assignments in the 399.00-400.05 MHz band is unlikely as uplink transmissions will only occur while over the SpaceQuest TT&C ground stations. The 399.0-400.05 MHz Earth-to-space band is allocated for UHF Little LEO data services and has been used by SpaceQuest experimentally for the past 5 years.

11.3 2200-2202MHz (Payload Downlink)

The GomSpaceSR2000 S-Band SDR Transmitter and ANT2000 Antenna is designed to operate in the 2200-2290 MHz band. In order to avoid interference with the U.S. Federal allocation S-Band downlink transmissions will operate at 2201 MHz band from Esrange, Sweden and LimeStone, Maine where .

The S-Band downlink carrier frequency of 2201 MHz will be used for the THEA satellite and coordinated with other authorized users of the band. S-Band operations will occur periodically at either LimeStone, Maine or Esrange, Sweden. Transmissions will be restricted as necessary to eliminate interference with other users of the band.

11.4 2045-2046 MHz (Payload Uplink)

SpaceQuest's S-Band satellite receiver and antenna system is designed to operate in the 2025-2110 MHz band. The S-Band uplink carrier frequency of 2045.5 MHz will be used for THEA and coordinated with other authorized users of the band.

The 2045-2046 MHz band was chosen for the THEA experimental license because it can be supported with the chosen S-Band radio equipment – the GomSpaceSR2000 S-Band SDR Receiver and ANT2000 Antenna.

Infrequent S-Band uplink transmissions from Limestone, Maine or Esrange, Sweden, will be used to load new firmware and to send confirmations of successful data packet downloads.

12 Power Flux Density Analysis

12.1 400.50-400.65 MHz (TT&C Downlink)

The Power Flux Density for the UHF downlink is within the ITU limits as shown in Figure 13.

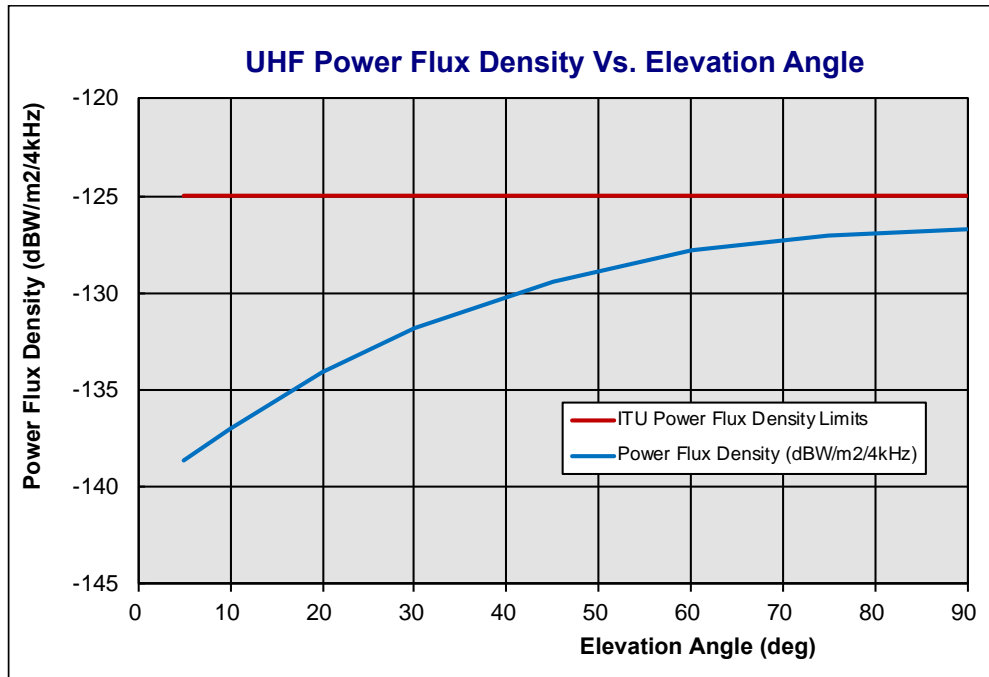

Figure 13 PFD at the Surface of the Earth for the UHF Transmitter Downlink

12.2 2200-2202 MHz (Payload Downlink)

The PFD for the S-Band downlink satisfies the ITU PFD limits as shown in Figure 14.

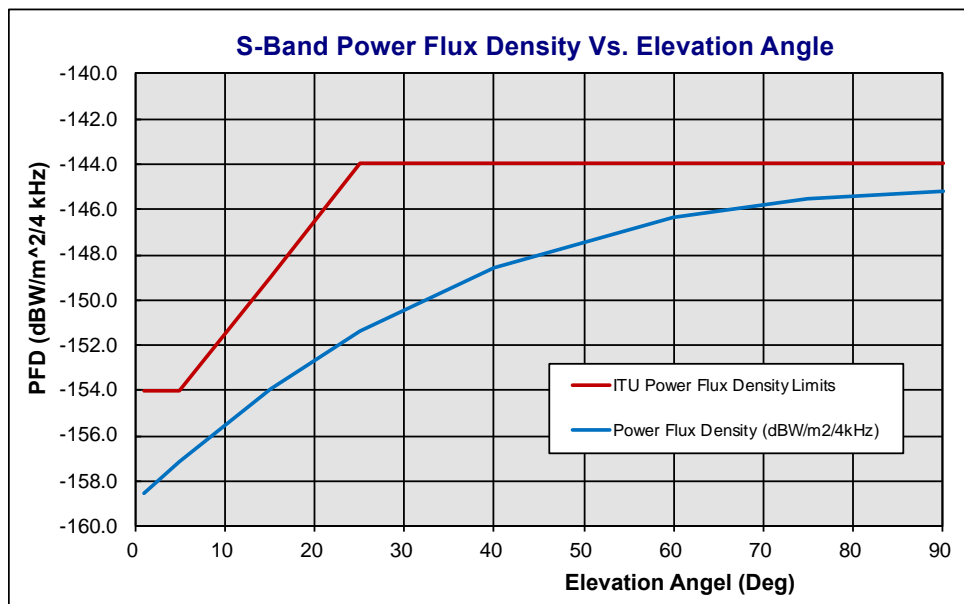

Figure 14 PFD at the Surface of the Earth for the S-Band Transmitter Downlink

13 Space Station Antenna Radiation Patterns

13.1 S-Band: THEA Space Station Transmit/Receive Antenna

The GomSpace NanoCom ANT2150 side-mounted S-Band Patch Antenna is used to downlink the THEA mission data. This circularly-polarized antenna incorporates an LNA designed to receive in the 2025-2110 MHz frequency band, and a Power Amplifier designed to transmit in the 2200-2290 MHz frequency band. The radiation pattern is shown in Figure 15.

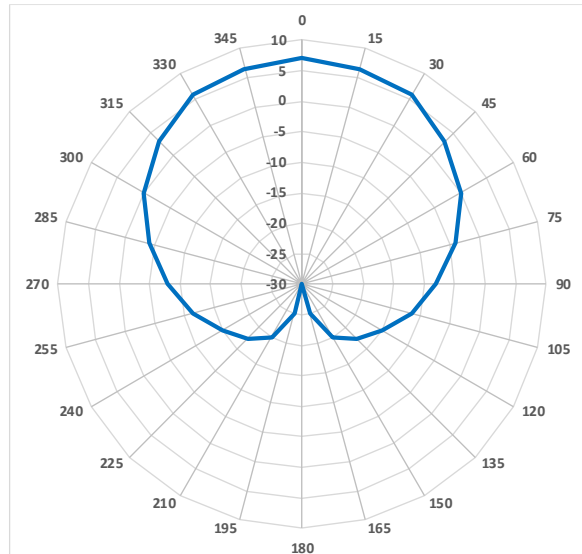

Figure 15 S-Band Satellite Transmit/Receive Antenna Radiation Pattern

13.2 UHF: THEA Space Station Transmit/Receive Antenna

An ISIS Deployable Omnidirectional UHF Monopole Antenna System is used to uplink and downlink TT&C data. It has a 0 dBi average gain and a radiation pattern shown in Figure 16.

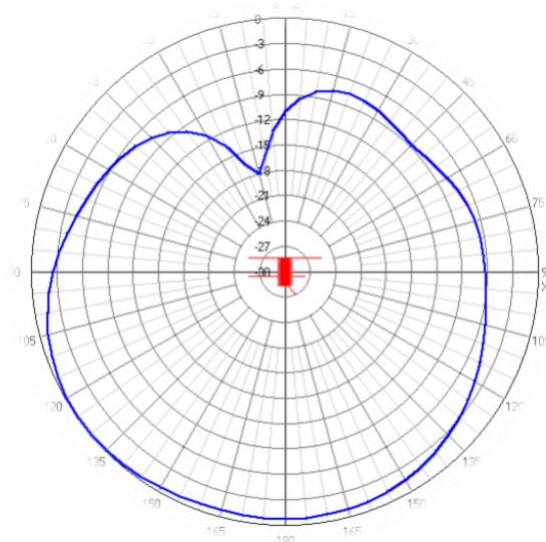

Figure 16 UHF Satellite Transmit/Receive Antenna Radiation Pattern.

13.3 Broadband: THEA Space Station Receive Antenna

A novel wideband antenna from Flexitech Aerospace is mounted in the “Tuna Can” of the THEA Cubesat. This receive-only antenna is used to capture RF spectrum in the frequency band from 1.35-7.075 GHz. The antenna pattern is a hemispheric 120° cone ($\pm 60^\circ$) with a peak gain at the center of the coverage envelope and a slow roll off to the -3dB point. A photo of Flexitech broadband antenna and its radiation pattern are shown in Figure 17.

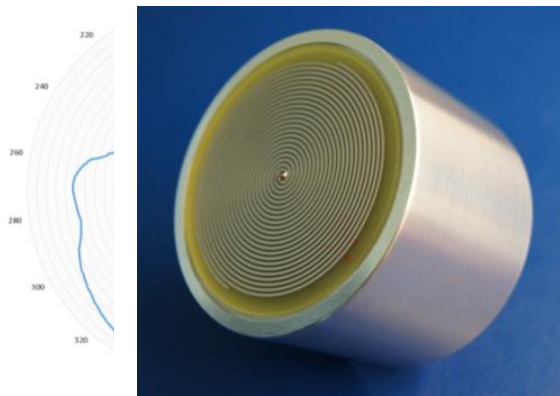

Figure 17 Flexitech Broadband Receive Antenna and Radiation Pattern.

13.4 Summary of THEA Antenna Characteristics

Figure 18 lists the antenna parameters for the three THEA antennas.

Antenna Parameter	S-Band	UHF	Wideband
Antenna Frequency Range:	2025-2290 MHz	399.9-400.6 MHz	1.35-7.075 GHz
Bandwidth Required:	2,000 KHz	150 KHz	N/A
Emission Designator:	2M00G1D	25K0F1D	N/A
Number of Channels:	1	1	Multiple
Space Station Class:	EH	ET	EH
Beam Name:	SBTX and SBRX	UTX and URX	WBRX
Emission/Receive	E/R	E/R	R
Max ISO. Gain	7.0 dBi	0.0 dBi	3.0 dB
Antenna Type:	Patch	Monopole	Cavity Backed Spiral
Polarization:	Circular	Linear	Circular
Peak Power:	1.0 Watts	3.0 Watts	Receive Only
Antenna Pattern:	See Figure 15	See Figure 16	See Figure 17
Link Margin:	See Figure 12	See Figure 11	Receive Only
Power Flux Density:	Within ITU limits. See Figure 14	Within ITU limits. See Figure 13	Receive Only

Figure 18 THEA Antenna Characteristics

14 Earth Station Antenna Radiation Patterns

Antenna patterns for SpaceQuest's UHF Earth Stations is shown in Figure 19.

14.1 UHF Antennas in Fairfax, VA, North Pole, AK and Naalehu, HI and Limestone, ME

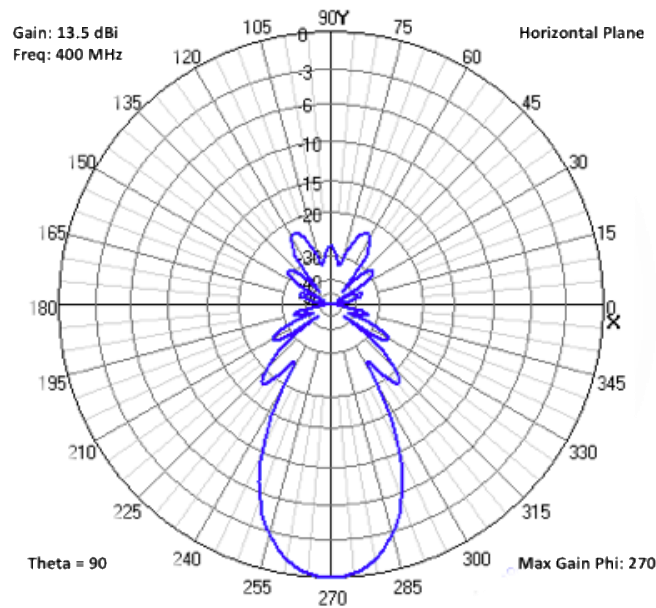

Figure 19 UHF Earth Station Antenna Radiation Pattern.

14.2 S-Band Earth Station Antenna in North Pole Alaska and Limestone, Maine.

SpaceQuest's S-Band antennas in Limestone, Maine and Esrangle, Sweden are for downloading the data captured by the Aurora payload. The Esrangle S-Band antenna will be used to upload new firmware to the satellite. An S-Band radiation pattern for these antennas is shown in Figure 20

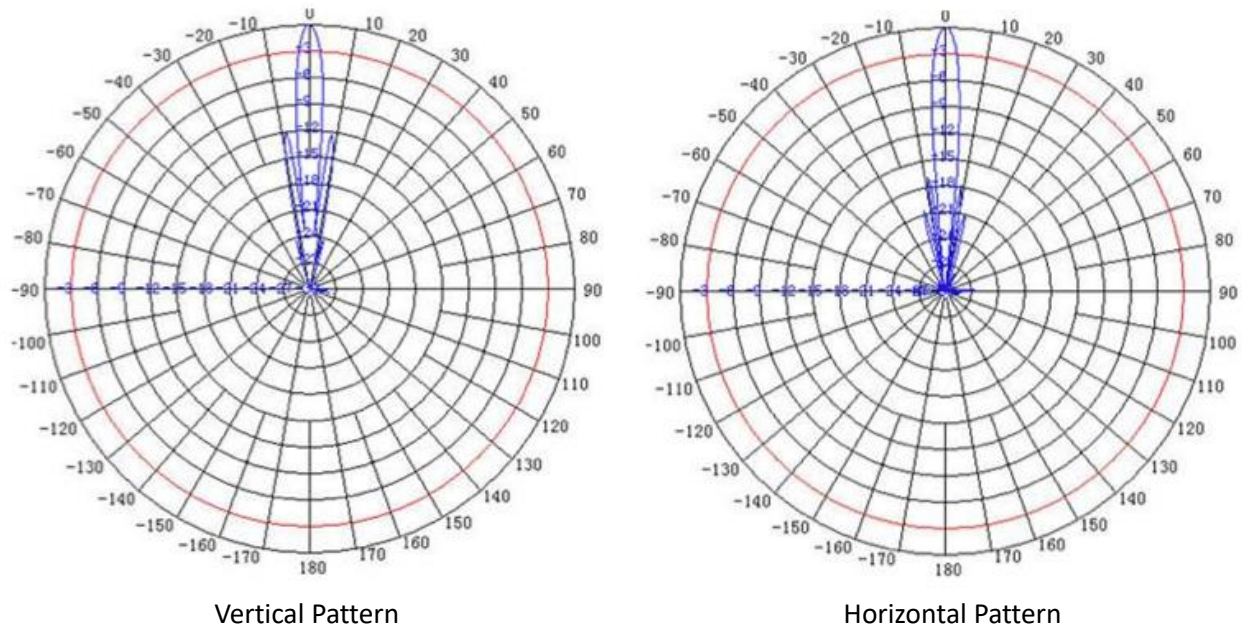

Figure 20 S-Band Earth Station Antenna Radiation Pattern.

15 Stop Buzzer POC

The 24-hour SpaceQuest contact for interference issues is provided below:

Name: Glenn Richardson

Email: glenn@spacequest.com

Tel: 703-424-7806