

January 27, 2015

**Panasonic Avionics Corporation**  
**Application for Two-Year Experimental Special Temporary Authority:**  
**T-PED Interference Testing at Sussex County Airport, Georgetown, DE**

**NARRATIVE DESCRIPTION**

Panasonic Avionics Corporation (“Panasonic”) requests a two-year experimental license commencing on **February 6, 2015**, to conduct ground testing in support of Panasonic’s Global Communications Suite (“GCS”) featuring the “eXConnect” Ku-band earth stations aboard aircraft (“ESAA”) system to provide broadband connectivity onboard aircraft in flight. It is requested that the experimental license be granted to conduct the testing onboard parked aircraft at the Sussex County Airport, Georgetown, DE.<sup>1</sup>

**Background**

On November 2, 2010, the FCC granted a two-year experimental license (Call Sign WF2XLF), effective until November 1, 2012, to conduct two types of testing: (1) electromagnetic interference (“EMI”) ground testing of multiple, simulated transmit portable electronic devices (“T-PEDs”) RF transmissions in the aircraft cabin in multiple frequency bands: GSM, cellular, Wi-Fi and others; and (2) picocell system operations in the aircraft cabin for enabling GSM phone communications for passengers and crew. Call Sign WF2XLF authorizes both T-PED interference and GSM picocell testing onboard parked aircraft at four sites: (1) Southern California Logistics Airport, Victorville, CA; (2) Paine Field Airport, Everett, WA; (3) Piedmont-Triad International Airport, Greensboro, NC; and (4) TSTC Waco Airport, Waco, TX.<sup>2</sup>

Subsequently, Panasonic has sought and received grants for multiple STAs and experimental licenses to conduct T-PED interference testing at multiple airfields, all of which authorizing the same test frequency bands. For example:

- Call Sign WG2XEE, a two-year experimental license at San Francisco International Airport, Denver International Airport, Chicago O’Hare International Airport, Melbourne, FL International Airport and Griffis International Airfield in Rome, NY;

---

<sup>1</sup> Panasonic notes that, January 23, 2015, it applied for a 180-day experimental Special Temporary Authorization (“STA”) for these same tests. (File No. 0079-EX-St-2015) On January 27, 2015, the FCC dismissed the application without prejudice and directed Panasonic to seek such authorizations via two-year experimental licenses. (See Letter, Nnake Nweke, OET, to Mark DeFazio, Panasonic Avionics Corporation, Jan. 27, 2015.) Accordingly, Panasonic is re-filing for a two-year experimental license.

<sup>2</sup> Prior to the application for and grant of Call Sign WF2XLF, in November 2009, the FCC granted an experimental STA for the same frequencies at these four sites (Call Sign WE9XDS). The application materials for WE9XDS include a detailed description of the proposed T-PED and picocell testing. For the Commission’s reference, a copy of Panasonic’s narrative statement accompanying the application for this earlier experimental STA is attached hereto as Attachment 1.

- Call Sign WF9XZA, an experimental STA at George Bush Intercontinental Airport in Houston, TX;
- Call Sign WG2XGI, a two-year experimental license at Tampa, FL International Airport and Lake City, FL Gateway Airport; and
- Call Sign WG2XZY, a two-year experimental licenses at Dallas/Fort Worth International Airport.

### **Request for Experimental License**

Panasonic is seeking the two-year experimental license beginning **February 6, 2015** to conduct T-PED interference ground testing at the Sussex County Airport, Georgetown, Delaware:

Sussex County Airport  
21553 10N-1  
Georgetown, DE 19947  
(Geographic Coordinates: 38-41-27 NL; 75-21-21WL)

Panasonic will conduct T-PED interference testing in the identified frequencies (see below in Table 1) using a signal generator to simulate the operation of multiple T-PEDs. Authorization for GSM picocell testing is not being sought in the instant application. The proposed testing will be conducted onboard parked commercial aircraft. Authorization is sought commencing **February 6, 2015**, and continuing for two years. (Given the relatively soon requested date of authorization, Panasonic has initiated frequency coordination efforts in those test bands identified in previous grants requiring this step.)

As Panasonic has explained in its previous applications, its access to aircraft is dependent upon the manufacturer, airline or other owner making the airplane available at a time convenient for them. Panasonic has only a short window – in most cases only a few days – once an airplane is available to conduct the testing before the airplane must be returned to the owner. Testing and re-testing in the authorized frequencies will be conducted at scheduled intervals during the periods that the airplanes are available within the authorized testing period.

Panasonic also notes that the Commission has previously granted an experimental authorization at the Sussex County Airport to OnAir for similar testing to determine the effect of T-PEDs on avionics systems prior to the installation of an onboard mobile telephony system. (Call Sign WG9XKI; File No. 0102-EX-ST-2013). Many of the same frequencies are included in the OnAir authorization.

### **Testing Plan and Frequencies**

Table 1 below lists the proposed test frequency bands. Also listed are the proposed wireless standards and associated technical information for each test band: modulation (pulse or continuous wave), maximum EIRP, maximum ERP, emission designator, among others. A single 1 MHz test frequency in each uplink band, also identified, will be used for testing. Except for the bands listed below, the proposed test bands are the same as the proposed test bands in the

currently authorized two-year experimental license W2XZY as well as in the several pending applications:

- 1427.9 – 1447.9 MHz
- 1447.9 – 1462.9 MHz
- 1626.5 – 1660.5 MHz
- 2300.0 – 2400.0 MHz
- 614.0 – 698.0 MHz

Panasonic is not seeking any changes in the other technical aspects in the proposed tests bands as previously authorized and as more fully described in the attached copy of the earlier experimental STA application (Call Sign WE9XDS) (Attachment 1).

Included as Attachment 2 is the “Stop Buzzer” contact for the proposed tests.<sup>3</sup>

\* \* \*

For the reasons described above, Panasonic respectfully requests the grant of a two-year experimental license at Sussex County Airport, Georgetown, DE on **February 6, 2015**.

---

<sup>3</sup> Panasonic will update the “Stop Buzzer” contacts as may be necessary upon grant of the requested experimental STA and prior to the scheduled start of any tests.

**Table 1 - T-PED EMI Test Frequencies / Transmit Power Requirements**

<b>Wireless Standard</b>	<b>Frequency start of band (MHz)</b>	<b>Frequency end of band (MHz)</b>	<b>Test Frequency (MHz)</b>	<b>Modulation</b>	<b>Test Waveform</b>	<b>Target EIRP (dBm)</b>	<b>Target EIRP (W)</b>	<b>Target ERP (W) ②</b>	<b>Emission Code</b>
CDMA 2000	410	420	415	CW	2	42.0	15.8	13.7	N0N
GSM 400	450.4	457.6	454	Pulse	1	45.0	31.7	29.5	P0N
CDMA 2000	450	460	455	CW	2	42.0	15.8	13.7	N0N
CDMA 2000	479	484	482	CW	2	42.0	15.8	13.7	N0N
600 MHz Band	614.0	698.0	656	CW	2	45.0	31.7	29.6	N0N
600 MHz Band	614.0	698.0	656	Pulse	1	45.0	31.7	29.6	P0N
CDMA 2000	776	794	785	CW	2	42.0	15.8	13.7	N0N
CDMA 2000	806	849	828	CW	2	42.0	15.8	13.7	N0N
CDMAone	824	849	828	CW	2	42.0	15.8	13.7	N0N
UMTS FDD	824	849	828	CW	2	42.0	15.8	13.7	N0N
GSM 850	824	849	828	Pulse	1	45.0	31.7	29.5	P0N
IS-136	824	849	828	Pulse	1	45.0	31.7	29.5	P0N
UMTS TDD	824	849	828	Pulse	1	45.0	31.7	29.5	P0N
CDMA 2000	870	925	898	CW	2	42.0	15.8	13.7	N0N
GSM 900	876	915	913	Pulse	1	45.0	31.7	29.5	P0N
LTE E-UTRA Band 11	1427.9	1447.9	1438	CW	2	35.0	3.16	1.06	N0N
LTE E-UTRA Band 11	1427.9	1447.9	1438	Pulse	1	35.0	3.16	1.06	P0N
LTE E-UTRA Band 21	1447.9	1462.9	1455	CW	2	35.0	3.16	1.06	N0N
LTE E-UTRA Band 21	1447.9	1462.9	1455	Pulse	1	35.0	3.16	1.06	P0N
Mobile Sat	1613.8	1626.5	1626	Pulse	1	42.0	15.8	13.7	P0N
LTE E-UTRA Band 24	1626.5	1660.5	1644	CW	2	35.0	3.16	1.06	N0N
LTE E-UTRA Band 24	1626.5	1660.5	1644	Pulse	1	35.0	3.16	1.06	P0N
CDMA 2000	1710	1785	1748	CW	2	42.0	15.8	13.7	N0N
DCS 1800	1710	1785	1748	Pulse	1	42.0	15.8	13.7	P0N

<b>Wireless Standard</b>	<b>Frequency start of band (MHz)</b>	<b>Frequency end of band (MHz)</b>	<b>Test Frequency (MHz)</b>	<b>Modulation</b>	<b>Test Waveform</b>	<b>Target EIRP (dBm)</b>	<b>Target EIRP (W)</b>	<b>Target ERP (W) ②</b>	<b>Emission Code</b>
CDMA 2000	1850	1910	1884	CW	2	42.0	15.8	13.7	N0N
UMTS FDD	1850	1910	1884	CW	2	42.0	15.8	13.7	N0N
CDMAone	1850	1910	1884	CW	2	42.0	15.8	13.7	N0N
UMTS TDD	1850	1910	1884	Pulse	1	42.0	15.8	13.7	P0N
PCS 1900	1850	1910	1884	Pulse	1	42.0	15.8	13.7	P0N
IS-136	1850	1910	1884	Pulse	1	42.0	15.8	13.7	P0N
UMTS TDD	1900	1920	1910	Pulse	1	36.0	4.0	1.8	P0N
CDMA 2000	1920	1980	1949	CW	2	42.0	15.8	13.7	N0N
UMTS FDD	1920	1980	1949	CW	2	42.0	15.8	13.7	N0N
UMTS TDD	2010	2025	2018	Pulse	1	36.0	4.0	1.8	P0N
UMTS/3G/PCN	2110	2170	2140	CW	2	36.0	4.0	1.8	N0N
LTE E-UTRA Band 40	2300	2400	2350	CW	2	35.0	3.16	1.06	N0N
LTE E-UTRA Band 40	2300	2400	2350	Pulse	1	35.0	3.16	1.06	P0N
802.11b/g	2400	2497	2412	Pulse	1	37.0	5.0	2.9	P0N
802.11b/g			2437	Pulse	1	37.0	5.0	2.9	P0N
802.11b/g			2462	Pulse	1	37.0	5.0	2.9	P0N
FDD LTE	2500	2685	2595	Pulse	2	42.0	15.8	13.7	P0N
FDD LTE	2500	2685	2595	CW	1	42.0	15.8	13.7	N0N
Wi-Max	3400	3600	3450	Pulse	2	42.0	15.8	13.7	P0N
Wi-Max	3400	3600	3450	CW	1	42.0	15.8	13.7	N0N
802.11a/n	5150	5250	5170	Pulse	1	37.0	5.0	2.9	P0N
802.11a/n	5250	5350	5300	Pulse	1	37.0	5.0	2.9	P0N
802.11a	5470	5725	5580	Pulse	1	37.0	5.0	2.9	P0N
802/11a/n	5725	5825	5825	Pulse	1	37.0	5.0	2.9	P0N

**ATTACHMENT 1**

**Narrative Statement Accompanying Panasonic Avionics Corporation's  
Application for Experimental STA Authority  
File No. 0550-EX-ST-2009; Call Sign WE9XDS**

## **NARRATIVE DESCRIPTION**

Panasonic Avionics Corporation (“Panasonic”) requests an experimental special temporary authority (“STA”) for 180 days commencing November 23, 2009 to conduct ground testing in support of Panasonic’s Global Communications Suite (“GCS”), featuring the “eXConnect” Ku-band aeronautical mobile-satellite service (“AMSS”) system for off-board connectivity for wireless communications links for transmit portable devices (“T-PEDs”), such as GSM phones and Wi-Fi enabled laptop computers. Using low-power wireless transceivers onboard the aircraft, GCS processes passenger communications for transmission to ground networks via satellite communications networks.

Authority is sought for two types of testing. The first type of testing will examine the potential for interference to airplane avionics and communications from passenger-carried T-PEDs. These tests will involve electromagnetic interference (“EMI”) ground testing of multiple, simulated T-PED RF transmissions in the aircraft cabin and will be conducted in several frequency bands, GSM, cellular, Wi-Fi, among others,, in which T-PEDS are authorized to operate in the United States and other countries. The second type of testing will examine the operations of picocell systems in the aircraft cabin for enabling GSM phone communications for passengers and crew. These tests will also be conducted onboard parked aircraft, and are designed to gather data on the operations and performance of the picocell systems.

### **I. Background**

There are generally two classes of wireless devices that have been authorized for use on board aircraft in flight: (i) devices using unlicensed Wi-Fi spectrum (e.g., notebook computers and PDAs operating at 2.4 GHz) for aeronautical broadband data services such as AirCell’s “Gogo Wireless” and the former Connexion by Boeing Ku-band AMSS service; and (ii) devices using licensed terrestrial CMRS spectrum (e.g., GSM phones, Blackberry devices, etc.) that have been limited to operating on foreign-registered aircraft outside the United States due to FCC and FAA restrictions. Panasonic seeks to conduct limited testing operations for both classes of devices.

Aeronautical broadband connectivity is a central component of Panasonic’s GCS offering, with the eXConnect Ku-band AMSS system providing the off-board link for the service. The devices used with this offering operate in unlicensed Wi-Fi frequency bands and there is substantial understanding of the technical and regulatory conditions associated with there use. Indeed, such devices operate in the air today with the AirCell Gogo Wireless system, which has been installed on a substantial number of U.S. commercial aircraft. Although the technical aspects of such operations are well-understood, Panasonic must conduct EMI testing with its specific system architecture in each aircraft type in which it seeks to operate in order to satisfy FAA certification requirements.

Panasonic similarly must test its proposed GSM operations onboard GCS equipped aircraft. Panasonic’s picocell system (called “eXPhone”) was designed in conjunction with

AeroMobile Limited (“AeroMobile”), a UK joint venture between ARINC and Telenor and the leading worldwide manufacturer of GSM picocell systems worldwide. AeroMobile’s GSM picocell systems have been authorized, sold and deployed on commercial aircraft serving Europe, Middle East and Asia. The system has been operating on an interference-free basis since its inception, but the new eXPhone architecture must be independently tested in individual aircraft types.

The proposed tests are similar in scope and duration to experimental testing previously authorized by the Commission. *See* Call Sign EB9XWP, File No. 0320-EX-ST-2004 (RF compatibility testing between T-PEDS and aircraft systems); Call Sign WC9XCX, File No. 0144-EX-ST-2005 (ground and flight testing of CDMS and GSM picocell systems for cellular and PCS transmissions); Call Sign WE2XQC, File No. 0136-EX-PL-2008 (ground and flight testing of GSM picocell systems). The experimental testing conducted under the last call sign listed above involved similar equipment from AeroMobile that is now being proposed for the current application for experimental testing authority. In addition, 2008 and 2009, AeroMobile received two different experimental STAs to demonstrate its GSM picocell system at a trade show. Call Sign WD9XLZ, File No. 0413-EX-ST-2008 and File No. 0433-EX-ST-2009.

## **II. Purpose of Experimental Tests**

*T-PED EMI Testing.* The proposed experimental EMI ground testing is needed to support Federal Aeronautics Administration (“FAA”) certification of Panasonic’s aircraft wireless connectivity systems and associated equipment. FAA regulations (14 C.F.R. § 91.21) stipulate that the aircraft operator demonstrate that onboard electronic devices, such as T-PEDs, not interfere with critical aircraft avionics systems. Industry documents, such as EUROCAE ED-130, RTCA DO-294, and RTCA DO-307,<sup>1</sup> provide guidelines on how to test avionics systems’ susceptibility to RF signals on board airplanes. The recommended tests involve the simulation of multiple T-PEDs transmitting simultaneously within the aircraft cabin across several frequencies that are used by mobile wireless and Wi-Fi equipment. The requested experimental STA will assist Panasonic and its partners in assessing the potential interference issues associated with the use of T-PEDs aboard commercial aircraft and developing the technical and operational requirements necessary to mitigate any potential interference issues to airplane avionics and communications.

*Picocell System Testing.* GSM picocell systems are already authorized to operate aboard aircraft in many foreign jurisdictions. In 2006, the European Conference of Postal and Telecommunications Administrations (“CEPT”) approved ECC (“Electronic Communications Committee”) Report 093,<sup>2</sup> which addresses the compatibility between

---

<sup>1</sup> ED-130, “GUIDANCE FOR THE USE OF PORTABLE ELECTRONIC DEVICES (PEDS) ON BOARD AIRCRAFT”; DO-294, “Guidance on Allowing Transmitting Portable Electronic Devices (T-PEDs) on Aircraft”; DO-307, “ Aircraft Design and Certification for Portable Electronic Device (PED) Tolerance” (“ED-130 Paper”) (attached). The other two cited documents are proprietary and not available publicly.

<sup>2</sup> CEPT ECC Report 093, "Compatibility between GSM equipment on board aircraft and terrestrial networks," September 2006.



GSM onboard aircraft equipment systems (“GSMOBA Systems”) and terrestrial networks. On the basis of this report, the ECC finalized a Decision (ECC/DEC/(06)07) in December 2006<sup>3</sup> (“ECC Decision”) that addresses the free circulation and harmonized usage of GSMOBA Systems<sup>4</sup> and sets out the technical limits which must be observed to ensure that these systems and their use do not cause harmful interference to terrestrial networks. Based on the ECC Decision, the European Telecommunications Standards Institute (“ETSI”) has developed a harmonized standard (ETSI EN 302 480) for GSMOBA System equipment<sup>5</sup>. This standard is a *de facto* type-approval standard that covers the essential requirements for placing radio equipment on the European market.

With the publication of the harmonized regime for Mobile Communications Onboard Aircraft in the European Union Official Journal in April 2008,<sup>6</sup> a common approach for both technical parameters and licensing aspects of the system is now in place for all 27 European Union Member States. One of the recommendations of this harmonized regime is that other countries which implement similar technical conditions for the service should be offered mutual recognition of their national licenses in the European Member states.<sup>7</sup>

CEPT-member European governments have issued licenses to airlines and other operators of GSM picocell systems on their fleets serving Europe. In addition, governments in the United Kingdom, Australia, United Arab Emirates, and Malaysia have also authorized the deployment and operation of picocell systems aboard airplanes, and already these systems are deployed on aircraft registered and operating in these countries. For example, 54 Emirates Airlines aircraft are equipped with the AeroMobile equipment, active to date on over 30,000 flights to 75 destinations in 40 countries.

Panasonic, in conjunction with its partners, desires to test picocell systems for eventual authorization and operation onboard foreign-registered aircraft as well as those registered and operating in the United States. (Of course, FCC and FAA rule changes would need to

---

<sup>3</sup> CEPT ECC Decision (06)07, “ECC Decision of 1 December 2006 on the harmonised use of airborne GSM systems in the frequency bands 1710-1785 and 1805-1880 MHz,” December 2006.

<sup>4</sup> While the ECC work focused on GSM-based systems, the same criteria and methodology are expected to apply to similar systems based on other mobile phone technologies.

<sup>5</sup> “Electromagnetic compatibility and Radio spectrum Matters (ERM); Harmonized EN for the GSM onboard aircraft system covering essential requirements of Article 3.2 of the R&TTE Directive”.

<sup>6</sup> European Commission Decision [EN] 2008/294/EC, “Commission decision of 7 April 2008 on harmonised conditions of spectrum use for the operation of mobile communication services on aircraft (MCA) in the Community,” European Union Official Journal, L 98/19, April 10, 2008. (The European Commission uses the technology neutral term “mobile communication services on aircraft” to describe the service.)

<sup>7</sup> The European Union uses the technology neutral term “mobile communication services on aircraft” (MCA).

be implemented to permit such US operations.) The purpose of the requested experimental STA is to verify and evaluate the effectiveness of the operation and performance of the picocell systems.

Panasonic seeks an experimental STA for 180 days, commencing on November 23, 2009,<sup>8</sup> to conduct the two types of ground testing described above. As further described below, the proposed testing schedule is dependent on the availability of aircraft. Panasonic has confirmed that a first aircraft is available for testing as of November 23, 2009, or a few days thereafter.

### **III. Description of Experiments**

*T-PED EMI Testing.* The planned testing will be conducted on standard commercial passenger airplanes parked at several airfields. An outside contractor under Panasonic's direction and control, will conduct the actual testing. The first step of the testing will be to undertake a system analysis for the specific aircraft configuration to be installed to determine those avionics systems that may be susceptible to interference from T-PED RF transmissions. A test plan will then be prepared for each aircraft, which will include the relevant T-PED transmission locations and power levels within the aircraft cabin. A signal generator in the aircraft cabin will be used to simulate the T-PED transmissions.

The aircraft avionics components and systems that are the subject of the proposed tests will operate while the aircraft is on the ground consistent with normal operations and protocols, including applicable power levels, and measured for any disruptive effects caused by the simulated T-PED transmissions. The testing will simulate multiple T-PED transmissions operating simultaneously. In order to assess the potential for interference -- *i.e.*, "worst case" scenarios -- to avionics systems and communications, it will be necessary to simulate multiple T-PEDs operating at relatively high power levels. The maximum transmit power levels of the simulated T-PEDs transmissions are limited to the power levels listed in the tables below, expressed as both ERP and EIRP.

*Picocell System Testing.* The testing of the picocell system will be conducted by Panasonic in conjunction with its approved contractors. eXPhone will be installed onboard on the same commercial passenger airplanes along with various GSM devices transmitting at a range of power levels. The primary purpose of the ground testing aboard aircraft is to gather data for aircraft cabin network design, system testing and avionics interference. Mobile GSM phone receivers and the picocell system will be transmitting during the ground testing.

AeroMobile will supply a picocell systems to Panasonic for testing to operate in the 1800 MHz GSM frequency. The picocell system consists of three pieces of equipment: a base transceiver radio frequency unit ("BTSRFU"), a cellphone radio frequency management unit ("CRFMU"), and an antenna combiner unit ("ACU"). The BTSRFU acts as the

---

<sup>8</sup> Panasonic anticipates filing shortly a companion application for an experimental STA to conduct similar experimentation with onboard wireless equipment during flight testing of the eXConnect system, including the eXPhone system.

equivalent of a terrestrial cell tower on the airplane, providing the RF connection to the mobile phones seeking to operate onboard a flight.

The CRFMU provides the RF management aboard the aircraft to ensure that onboard phones do not receive signals from terrestrial networks but communicate only with the BRSRFU. System software and GPS information ensures that the CRFMU transmits in bands associated with terrestrial networks depending on the plane’s location. The CRFMU, in effect, desensitizes those onboard mobile phones and other transmitting devices that do not operate in the GSM bands for which the picocell system is designed from attempting to connect to a terrestrial network. This RF “shield” will be different depending on the frequency band(s) associated with the terrestrial networks that the plane is passing over during its flight, thus preventing the mobile phones and other transmitting devices from communicating with or causing interference to the terrestrial networks. At the same time, the picocell system will enable GSM mobile phones to connect with the appropriate terrestrial networks via the aircraft’s Ku-Band antenna. The picocell system will perform this function by lowering the transmit power levels of the GSM phones so that they do not seek to connect to a terrestrial network, but rather with the BRSRFU to complete the RF connection.

The ACU combines the transmitted signals from the BTRSRFU and CRFMU for transmission in the aircraft cabin using a “leaky feeder cable” to provide sufficient RF coverage throughout the airplane cabin. The maximum transmit power for the GSM devices is limited to the power requested in this experimental STA request.

**IV. Testing Intervals and Locations**

For both the T-PED interference and picocell system, testing and re-testing will be conducted at scheduled intervals within the authorized testing period, each test interval lasting approximately three (3) days. Although the T-PED interference and picocell system testing cannot be conducted simultaneously, the two types of testing will be conducted consecutively on a single aircraft within the same testing intervals.

The proposed testing will be conducted on the ground at the following four (4) airport facilities:

<b>Facility</b>	<b>Coordinates</b>
Southern California Logistics Airport, Victorville, CA	34° 35' 51" N, 117° 22' 59" W
Paine Field / Snohomish County Airport, Everett, WA	47° 54' 22" N, 122° 16' 53" W
Piedmont-Triad International Airport, Greensboro, NC	36° 5' 52" N, 79° 56' 14" W
TSTC Waco Airport, Waco, TX	31° 38' 16" N, 97° 4' 45" W

Panasonic's ability to conduct the proposed tests is dependent on the availability of aircraft, including new Boeing aircraft that are coming off the production line as well as existing aircraft that are scheduled to be taken out of service for routine maintenance, equipment upgrade, etc. Once an airplane becomes available, Panasonic will have only a few days to conduct the testing prior to delivery to the airline, in the case of a new airplane, or return to service.

Specifically, Panasonic has already coordinated with an airline to have access to a new airplane that will be flown in late November/early December to the Victorville, CA site for prior-to-service modifications. This plane will be made available to Panasonic for a short period at the end of this period. Panasonic anticipates conducting both the proposed T-PED interference testing and the picocell system testing.

In addition, Panasonic anticipates having access to an additional airplane in early December at the Greensboro, NC site that is scheduled to be pulled out of service for installation of Panasonic's eXConnect system for broadband service at 2.4 GHz. Panasonic anticipates only conducting T-PED interference testing in the 2.4 GHz Band.

The proposed tests will be conducted in closed areas of the identified airport facilities, where access will be limited to authorized personnel and away from any public terminals and any other facilities not under Panasonic's or other partners' control.

As the two examples above illustrate, Panasonic's access to aircraft is limited to their being made available by either the manufacturer or airline on a convenient schedule for them. Further, the airplanes will be available to Panasonic only for short intervals of a few days prior to their being delivered or returned to service. An experimental STA for 180 days is necessary to enable Panasonic to access a sufficient number of airplanes to conduct the proposed T-PED interference and picocell System testing on a schedule convenient to the manufacturer or airline.

## **V. Test Frequencies and Other Technical Information**

*T-PED Interference Testing.* The table below identifies the relevant frequencies in which Panasonic proposes to conduct the T-PED interference testing. Additional technical information, such as the relevant power levels and modulation types, is also provided in the Table 1, below:

**Table 1 - T-PED EMI Test Frequencies / Transmit Power Requirements**

Wireless Standard	Frequency start of band (MHz)	Frequency end of band (MHz)	Frequency span (MHz)	Modulation type	Max EIRP permitted (dBm)	Target MEF (dB)	Target EIRP (dBm)	Target ERP (W) ②
GSM 450	450.2	457.6	7.4	pulse	33	12	45	31.6
GSM 480	478.8	486	7.2	Pulse	33	12	45	31.6
i-DEN	806	825	19	pulse	33	12	45	31.6
GSM 850	824	849	25	pulse	33	12	45	31.6
IS-136 & 54	824	849	25	pulse	30	12	42	15.8
UMTS TDD	824	849	25	pulse	24	12	36	4
GSM 900+	876	915	39	pulse	33	12	45	31.6
PDC	887	889	2	pulse	30	12	42	15.8
i-DEN	896	901	5	pulse	33	12	45	31.6
PDC	893	901	8	pulse	30	12	42	15.8
PDC	915	958	43	pulse	30	12	42	15.8
i-DEN	1453	1465	12	pulse	33	12	45	31.6
PDC	1477	1501	24	pulse	30	12	42	15.8
DCS 1800	1710	1785	75	pulse	30	12	42	15.8
PCS 1900	1850	1910	60	pulse	30	12	42	15.8
IS-136	1850	1910	60	pulse	30	12	42	15.8
UMTS TDD	1850	1910	60	pulse	24	12	36	4
PHS	1895	1918	23	pulse	13	12	25	0.3
UMTS TDD	1900	1920	20	pulse	24	12	36	4
UMTS TDD	2010	2025	15	pulse	24	12	36	4
UMTS 2100	2110	2170	60	pulse	27	12	39	7.9
CDMA2000	479	484	5	CW	30	12	42	15.8

Panasonic Avionics Corporation

Wireless Standard	Frequency start of band (MHz)	Frequency end of band (MHz)	Frequency span (MHz)	Modulation type	Max EIRP permitted (dBm)	Target MEF (dB)	Target EIRP (dBm)	Target ERP (W) <sup>②</sup>
CDMA2000	776	794	18	CW	30	12	42	15.8
CDMA2000	806	849	43	CW	30	12	42	15.8
UMTS FDD	824	829	5	CW	24	12	36	4
NAMPS/AMPS	824	849	25	CW	30	12	42	15.8
CDMAone	824	849	25	CW	30	12	42	15.8
CDMA2000	870	925	55	CW	30	12	42	15.8
LTE Japan	1427.9	1452.9		CW	24	12	36	4
CDMA2000	1710	1785	75	CW	30	12	42	15.8
CDMA2000	1850	1910	60	CW	30	12	42	15.8
UMTS FDD	1850	1910	60	CW	24	12	36	4
CDMAone	1850	1910	60	CW	30	12	42	15.8
CDMA2000	1920	1980	60	CW	30	12	42	15.8
UMTS FDD	1920	1980	60	CW	24	12	36	4
China (TDD)	2010	2025	15	CW	27	12	39	7.9
WiMAX	2300	2400	100	CW	25	12	37	5
Wi-Fi	2400	2484	84	pulse	27	12	39	7.9
Wi-Fi	5150	5250	100	pulse	27	12	39	7.9
Wi-Fi	5250	5350	100	pulse	27	12	39	7.9
Wi-Fi	5725	5825	100	pulse	27	12	39	7.9
LTE	2500	2690	190	CW	24	12	36	4

- Pulse modulated = pulse length of 625 μs, PRF of 200 Hz
- CW = continuous wave, unmodulated
- ② Using a reference half-wave dipole antenna

Panasonic notes that the proposed frequency bands include bands used outside the United States for T-PED and cellular services. (Where relevant, Table 1 shows the corresponding non-US band allocation.) Panasonic anticipates that passengers will bring on board -- and seek to operate -- T-PED and cellular and GSM devices that are enabled to transmit in non-US authorized frequency bands. In other words, airplanes flying in US airspace will include devices not technically limited to operating on US frequencies, and the airplanes must be tolerant for worldwide authorized T-PEDs. The planned EMI testing is intended to replicate the potential RF transmissions of multiple T-PEDs operating in multiple frequency bands (US and foreign), and ascertain the effect, if any, these transmissions may have on aircraft avionics and communications. The proposed frequency bands in Table 1 are taken from similar T-PED testing that AeroMobile has conducted outside the United States and include the top, middle and bottom of relevant frequency bands to account for non-US licensed T-PED devices.

In addition, the T-PED testing is based on the recommendations and guidance set forth in the attached ED-130 Paper. Panasonic proposes to test various modes of modulation, bandwidth and data rates across the multiple bands listed in Table 1. Details regarding these technical elements of the tests are found in the ED-130 Paper at pp. 47-58.

*Picocell System Testing.* Panasonic proposes to test the picocell systems in the primary US bands allocated to cellular and PCS services, as identified below in Table 2.

Table 2: Picocell System Testing / Transmit Power Requirements

Type of Service	Band Lower Limit (MHz)	Band Upper Limit (MHz)	Modulation Type	Authorized Power (dBm)	ERP (W) (assuming half wave dipole antenna)	Field Strength @ 1 meter, assuming iso antenna (V/m)*
Cellular	421	494	CW	29	0.5	0.04
Cellular	806	894	pulse	29	0.5	0.07
PCS	921	960	pulse	29	0.5	0.07
PCS	1805	1880	pulse	32	1	0.09
GSM*	1805	1880	pulse	27.5	0.3	0.05
PCS	1930	1990	CW	32	1	0.08
AWS	2110	2170	CW	29	0.5	0.16

- o Pulse modulated = pulse length of 625  $\mu$ s, PRF of 200 Hz
- o CW = continuous wave, unmodulated

As described above in Section III, the GSM picocell system functions by communicating with GSM devices on specific frequency bands, and desensitizing other wireless devices so that they are unable to attempt to connect to a terrestrial network. The GSM picocell systems to be tested will communicate in the 1805-1880 MHz band (marked with a \*) and desensitize those devices operating in all other listed bands. The picocell system will complete the off-board connection to the terrestrial network via the aircraft's Ku-band antenna.

Prior to transmission, Panasonic will coordinate the tests with local licensees as appropriate in the bands authorized to prevent possible interference.

## **VI. Conditions and Contacts**

Panasonic acknowledges that the planned tests are not to cause interference to licensed services and are subject to immediate shut down should any harmful interference occur and until the interference issues are resolved.

During the testing periods, Panasonic will make available 24/7 personnel with authority to be contacted with reports of harmful interference. This personnel shall have the authority to shut down testing immediately upon receipt of any such reports. The Panasonic personnel are:

Lead Contact:

Brian Kirby  
Panasonic Avionics Corporation  
425-415-9028 (office)  
425-273-3995 (cellular)  
brian.kirby@panasonic.aero

Secondary Contact:

Scott Toner  
Panasonic Avionics Corporation  
425-415-9581  
425-891-6298 (cellular)  
scott.toner@panasonic.aero

Panasonic further notes that the Commission previously authorized testing of picocell systems under its general authority to authorize experimental radio operations pursuant to Part 5 of its Rules (47 C.F.R. Part 5). *See, e.g.*, Call Sign WX9XCX, File No. 0144-EX-ST-2005. Accordingly, Panasonic is not seeking a waiver of FCC Rule 22.295 (47 C.F.R. § 22.295) to conduct the proposed picocell system experimental testing.

## **VII. Conclusion**

The planned ground tests will provide important information to Panasonic and its partners regarding the effects on aviation avionics and communications from T-PED operations onboard eXConnect-equipped aircraft. In addition, testing of the picocell systems will enable Panasonic to evaluate and verify their operation for eventual authorization and operation in the United States. Panasonic respectfully requests an experimental STA for a period 180 days commencing November 23, 2009.





The European Organisation for Civil Aviation Equipment  
L'Organisation Européenne pour l'Équipement de l'Aviation Civile

## **GUIDANCE FOR THE USE OF PORTABLE ELECTRONIC DEVICES (PEDs) ON BOARD AIRCRAFT**

This document is the exclusive intellectual and commercial property of EUROCAE.

It is presently commercialised by EUROCAE.

**This electronic copy is delivered to your company/organisation for internal use exclusively.**

In no case it may be re-sold, or hired, lent or exchanged outside your company.

**ED-130**

December 2006

# GUIDANCE FOR THE USE OF PORTABLE ELECTRONIC DEVICES (PEDs) ON BOARD AIRCRAFT

This document is the exclusive intellectual and commercial property of EUROCAE.

It is presently commercialised by EUROCAE.

**This electronic copy is delivered to your company/organisation for internal use exclusively.**

In no case it may be re-sold, or hired, lent or exchanged outside your company.

## **ED-130**

December 2006

## FOREWORD

1. This document has been developed in mutual consultation with RTCA SC 202. It focuses on electromagnetic interference aspects and operational guidance for the use of PEDs. It provides procedures and recommendations compatible with those in RTCA DO-294A.
2. Whenever a reference document appears in this document, it carries the minimum revision level of the reference document acceptable to meet the intended requirements. Later versions of the reference document are also acceptable but earlier versions are not acceptable. In all cases, other documents shown to be equivalent to the reference document are also acceptable.
3. EUROCAE and RTCA, Inc. are, respectively, International and US not-for-profit organisations, formed to advance the art and science of aviation and aviation electronic systems for the benefit of the public.
4. Since EUROCAE or RTCA are not official agencies of any European or US government, their recommendations may not be regarded as statements of official government policy unless so enunciated by the appropriate government organization, conference of governments, or agency having statutory jurisdiction over any matters to which the recommendations relate.
5. Details of any amendments and updates of this document may be found on the Eurocae web site: [www.eurocae.org](http://www.eurocae.org)
6. Copies of this document may be obtained from:

### EUROCAE

102 rue Etienne Dolet  
92240 MALAKOFF  
France

Tel: 33 1 40 92 79 25

Fax: 33 1 46 55 62 65

Email: [eurocae@eurocae.net](mailto:eurocae@eurocae.net)

Web Site: [www.eurocae.org](http://www.eurocae.org)

## EXECUTIVE SUMMARY

This document provides guidance for aircraft operators, airframers and authorities on the potential effects of portable electronic devices (PED) and intentionally transmitting portable electronic devices (T-PED) and their usage onboard aircraft and associated risk mitigation. Both, operational guidance and processes to demonstrate electromagnetic compatibility (EMC) between PED or T-PED and aircraft electronics are given.

After the introduction into the document's organization in chapter 1, chapter 2 introduces general electromagnetic interference issues potentially associated with the use of PEDs on board aircraft. While usage of PED is common today and rules already exist as described in chapter 3, additional guidance is given this chapter, which is closely linked with annex 1 concerning usage of T-PED and other PED in the aircraft's flight phases. If an operator controlled PED is foreseen for usage during all flight phases, it will usually be considered appropriate to qualify those PEDs against ED-14E/DO160E, section 21, Category H. Usage of PED not under aircraft operator's control should be limited to non-critical phases of flight. In addition recommendations are given to incorporate PED cabin signage. Annex 8 provides a copy of the RTCA SC202 proposed FAR revisions to incorporate PED usage signage, in line with recommendation indicated in chapter 3. WG 58 suggests producing analogue guidance within the European CS 25 and/or JAR OPS.

Operational approval for usage of intentionally transmitting PED deserves additional assessment. Chapter 4 outlines the general process recommended once an intentionally radiating T-PED technology, which is new to the aircraft, should be introduced. Three different emission cases are investigated: Intentional radio frequency emission, unwanted low-level radiated spurious emissions, and conducted emissions.

For the intentional radiated emissions a process is defined to demonstrate electromagnetic compatibility with the aircraft equipment. The process references analysis and protection levels based on annexes 2 and 4 of this document, which evaluate existing communication standards (annex 2) and provide equipment qualification levels (annex 4). Associated qualification methods are outlined but not finally described in Annex 3. Especially existing ED-14E/DO-160E susceptibility qualification may lead to over testing as section 20 of ED-14 requires far field qualification. The exposure of equipment to T-PEDs will likely be near field. However, for the time being the ED-14E/DO-160E, section 20, test setups are recommended, while test modulation and levels may deviate from that (see annex 4).

For aircraft whose equipment according to chapter 4 cannot be fully analyzed being T-PED-tolerant the EMC demonstration may be based on aircraft testing. Annex 5 describes some preparation for such aircraft testing regarding especially multiple device assessment and potential cumulative effects from multiple T-PED. A sample test procedure is outlined in annex 6. Annex 7 provides a sample analysis for the aircraft testing preparation and application of the process of chapter 4.

## TABLE OF CONTENTS

FOREWORD .....		I
EXECUTIVE SUMMARY .....		II
LIST OF FIGURES .....		VI
CHAPTER 1	INTRODUCTION .....	1
1.1	PURPOSE AND SCOPE OF THE DOCUMENT .....	1
1.2	ORGANISATION OF THE DOCUMENT .....	2
1.3	CAUTION .....	2
CHAPTER 2	DESCRIPTION OF INTERFERENCE ISSUES .....	3
2.1	PRESENTATION OF THE PROBLEM .....	3
2.1.1	Portable electronic devices: definition .....	3
2.1.2	Problem statement .....	3
2.1.3	PED emission classification .....	4
2.1.4	The coupling paths .....	6
2.1.5	Identification of the potential interference issues .....	7
2.1.6	Acknowledgement of previous studies .....	7
CHAPTER 3	CURRENT PED RECOMMENDED PRACTICES .....	13
3.1	DEFINITION OF PHASES OF OPERATION .....	13
3.2	EASA GENERAL REQUIREMENT .....	13
3.3	PED REQUIREMENTS .....	13
3.4	PED RECOMMENDED POLICY .....	14
3.5	TECHNICAL SUBSTANTIATION .....	15
3.5.1	Aim of the PED policy .....	15
3.5.2	Spurious emissions from PED not under operator control (NIRA)....	15
3.5.3	Intentional emissions from PED not under operator control (IRU, IRC and IRA) .....	16
3.5.4	Portable electronic devices under control of the aircraft operator....	17
3.5.5	In flight experience .....	17
3.6	RECOMMENDATION FOR APPLICATION OF THE PED POLICY .....	18
3.6.1	Announcements .....	18
3.6.2	Action and awareness of cabin crew .....	18
3.6.3	Flight phases cruise, take off and landing .....	18
3.6.4	Flight phases taxi in, taxi out, stationary aircraft .....	19
3.6.5	Reporting .....	21
3.6.6	Long-term recommendations .....	21
CHAPTER 4	GUIDANCE FOR THE OPERATIONAL APPROVAL OF T-PED TECHNOLOGIES NEW TO THE AIRCRAFT .....	22
4.1	PURPOSE AND SCOPE OF THE PROCEDURE .....	22
4.1.1	Use of operator controlled intentionally transmitting devices .....	24
4.1.2	Use of intentionally transmitting devices not under operator's control	24
4.1.3	Overview: the procedure and associated sections in the document.	25

4.2	PART 1: INTENTIONAL RADIATED EMISSIONS.....	26
4.2.1	General Considerations.....	26
4.2.2	Guidelines for backdoor coupling immunity qualification .....	27
4.3	PART 2: SPURIOUS RADIATED EMISSIONS.....	31
4.3.1	Devices intended for use during cruise phase of the flight only.....	31
4.4	PART 3: CONDUCTED EMISSIONS .....	31
ANNEX 1	GUIDANCE TO AIRCRAFT OPERATORS FOR DEVELOPMENT OF STANDARDISED PED POLICIES AND PROCEDURES .....	33
A.1.1	DEVELOPMENT OF COMMON PED POLICIES AND PROCEDURES .....	33
A.1.2	FACTORS INFLUENCING DEVELOPMENT OF T-PED POLICIES AND PROCEDURES .....	33
A.1.2.1	Regulatory requirements.....	33
A.1.2.2	Differing aircraft types within Aircraft Operators fleet.....	33
A.1.2.3	International Harmonisation .....	34
A.1.2.4	Human factors related requirements for an effective policy.....	34
A.1.2.5	Identification of PEDs.....	35
A.1.3	GENERAL GUIDANCE FOR DEVELOPMENT OF AN OPERATOR-SPECIFIC PED POLICY .....	35
A.1.3.1	Basic guidelines .....	35
A.1.3.2	Crew PED Usage .....	35
A.1.3.3	Initial T-PED policy development, reviews and updates .....	36
A.1.3.4	Communications complexity.....	36
A.1.3.5	Passenger-Targeted Communications.....	36
A.1.3.6	Flight Deck Crew and Cabin Crew Training .....	38
A.1.3.7	Coordination with Airline Ground Staff and Handling Agents .....	39
A.1.3.8	PED Policy Template .....	39
A.1.3.9	General PED Restriction .....	39
A.1.3.10	Unrestricted Use.....	40
A.1.3.11	Restricted Use .....	40
A.1.3.12	Controlled Use.....	41
A.1.4	PROHIBITED USE .....	42
A.1.5	SPECIAL CASE USAGE .....	43
ANNEX 2	ASSESSMENT OF THE FIELD STRENGTH GENERATED BY INTENTIONAL TRANSMITTERS.....	44
A.2.1	EMI CHARACTERIZATION OF RADIO COMMUNICATION STANDARDS ...	45
A.2.2	TRANSMITTING POWER AND FIELD STRENGTH .....	45
A.2.3	WIRELESS COMMUNICATION STANDARDS.....	46
A.2.3.1	Pulse and Amplitude Modulated Standards.....	47
A.2.3.2	FDMA/CDMA and other CW-like Standards .....	52
A.2.4	CONCLUSION ON TEST SIGNAL WAVEFORMS .....	58
A.2.5	REQUIRED FIELD STRENGTH LEVELS AND POWER LEVELS.....	59
A.2.6	REQUIRED POWER LEVEL AND FIELD STRENGTH ENVELOPES FOR LABORATORY EQUIPMENT QUALIFICATION.....	64
A.2.7	CONCLUSION.....	69

ANNEX 3	QUALIFICATION OF AIRCRAFT EQUIPMENT AGAINST INTENTIONAL EMISSIONS OF PEDS .....	71
A.3.1	EQUIPMENT QUALIFICATION TEST METHODS .....	71
A.3.2	TRANSMITTED POWER TEST PROCEDURE .....	71
A.3.3	TEST SIGNAL LEVELS FOR TRANSMITTED POWER EQUIPMENT TEST .....	72
A.3.4	ELECTRIC FIELD TEST PROCEDURE .....	72
A.3.5	TEST SIGNAL LEVELS FOR ELECTRIC FIELD EQUIPMENT TEST .....	73
A.3.6	CONCLUSION.....	73
ANNEX 4	IDENTIFICATION OF QUALIFICATION LEVELS CONCERNING BACKDOOR SUSCEPTIBILITY .....	75
A.4.1	IDENTIFICATION OF THE QUALIFICATION LEVELS .....	75
A.4.2	GENERAL AIRCRAFT EQUIPMENT IMMUNITY LEVELS .....	75
A.4.2.1	Aircraft manufacturer's data .....	75
A.4.2.2	Default levels from HIRF qualification .....	76
A.4.3	ELECTRIC FIELD TEST LEVELS FOR EQUIPMENT QUALIFICATION .....	76
A.4.4	EXAMPLES OF SETS OF QUALIFICATION LEVELS .....	78
ANNEX 5	PREPARING AIRCRAFT TESTING AGAINST THE INTENTIONAL EMISSION OF T-PEDS.....	79
A.5.1	AIRCRAFT TESTING PREPARATION (MULTIPLE DEVICE RISK ASSESSMENT FOR AIRCRAFT INTERACTION TESTING).....	79
A.5.1.1	Multiple device risk assessment for aircraft interaction testing .....	79
A.5.1.2	Accumulation of spurious emissions .....	81
A.5.1.3	Accumulation of Intentionally Transmitted Signals from T-PEDs.....	81
ANNEX 6	PROCEDURE FOR FUNCTIONAL AIRCRAFT TESTING .....	84
A.6.1	INTRODUCTION .....	84
A.6.1.1	Purpose of test .....	84
A.6.1.2	Airworthiness requirements.....	84
A.6.2	AIRCRAFT CONDITION BEFORE TEST .....	84
A.6.2.1	Power Supply .....	84
A.6.2.2	Aircraft Environment.....	84
A.6.2.3	Regulatory aspects.....	85
A.6.2.4	Other tests to be performed previous to functional aircraft testing ...	85
A.6.2.5	Status of Systems .....	85
A.6.2.6	Safety Instructions.....	86
A.6.3	TEST DESCRIPTION INCLUDING TEST EQUIPMENT .....	87
A.6.3.1	Test equipment.....	87
A.6.3.2	Test requirements/description.....	87
A.6.3.3	Test close up .....	92
A.6.3.4	Test report .....	92
ANNEX 7	AIRCRAFT TESTING APPLICATION EXAMPLE .....	93
ANNEX 8	PROPOSED FAR REVISIONS TO INCORPORATE PED USAGE SIGNAGE	96
A.8.1	§ 25.791 PASSENGER INFORMATION SIGNS AND PLACARDS .....	96
A.8.2	§ 91.517 PASSENGER INFORMATION .....	96
A.8.3	§ 91.1035 PASSENGER AWARENESS .....	97

A.8.4	§ 121.317 PASSENGER INFORMATION REQUIREMENTS, SMOKING PROHIBITIONS, AND ADDITIONAL SEAT BELT REQUIREMENTS .....	98
A.8.5	§ 121.571 BRIEFING PASSENGERS BEFORE TAKEOFF .....	100
ANNEX 9	INDEX OF DEFINITIONS .....	102
ANNEX 10	INDEX OF REFERENCES .....	104
CHAPTER 5	LIST OF EUROCAE WG-58 MEMBERS.....	106
CHAPTER 6	ED-130 IMPROVEMENT SUGGESTION FORM.....	107

## LIST OF FIGURES

Figure 1 : Example of PED emissions .....	4
Figure 2 : Considered coupling paths for radiated coupling in order to assess interference.....	6
Figure 3 : Conducted coupling to aircraft wiring .....	6
Figure 4 : Basic principle of EMC analysis .....	7
Figure 5 : Front door coupling due to radiated spurious emissions (NIRA).....	8
Figure 6 : Front door coupling of radiated intentional emissions (IRA) .....	9
Figure 7 : Back door coupling of radiated emissions (IRU, NIRU, IRC, IRC).....	10
Figure 8 : Recommended content and timing of announcements regarding permitted use of PEDs / T-PEDs .....	20
Figure 9 : Example for "No electronic Devices" Signage .....	21
Figure 10 : Demonstration process to apply according to the type of portable device.....	25
Figure 11 : Process for backdoor coupling immunity qualification .....	30
Figure 12 : Test waveform for standards using TDMA or CSMA/FHSS schemes .....	52
Figure 13 : CW-waveform for standards providing no pulse modulation.....	58
Figure 14 : Required field strength levels onto EUT for worst-case scenario for pulse-modulated T-PED signals including 6dB margin.....	60
Figure 15 : Required field strength levels onto EUT for CW-like T-PED signals including 6dB margin .....	61
Figure 16 : Required power levels at a 0.1 m distance between test antenna and EUT for pulse modulated (TDMA) T-PED signals including 6dB margin .....	62
Figure 17 : Required power levels at a 0.1 m distance between test antenna and EUT for CW-like (FDMA) T-PED signals including 6dB margin.....	63
Figure 18 : Required radiated field strength levels for pulse-modulated (TDMA) T-PED signals including 6 dB margins for laboratory equipment qualification .....	65
Figure 19 : Required radiated field strength for CW-like (FDMA) T-PED signals including 6 dB margins for laboratory equipment qualification .....	66
Figure 20 : Required radiated power levels for 0.1m distance between test antenna and EUT for pulse-modulated (TDMA) T-PED signals including 6 dB margins for laboratory equipment qualification.....	67
Figure 21 : Required radiated power levels for 0.1m distance between test antenna and EUT for CW-like (FDMA) T-PED signals including 6 dB margins for laboratory equipment qualification.....	68
Figure 22 : Block diagram for testing with the help of the transmitted power.....	71
Figure 23 : Block diagram for test with electric field calibration.....	72
Figure 24 : Aircraft testing process.....	80
Figure 25 : MEF (dB) vs. Minimal distance between sources (m).....	83
Figure 26 : Test set-up for aircraft interaction test.....	90
Figure 27 - Antenna set-ups for cabin and cockpit tests .....	91



## LIST OF TABLES

Table 1 : Main characteristics of intentional and spurious emissions.....	5
Table 2 : Coupling paths and interaction scenarios to be investigated .....	7
Table 3 : Potential interference issues, completed with the previous studies' conclusions Red: interference can happen and could have serious consequences Yellow: interference can happen and could have only minor consequences Green: Interference is unlikely (light green), unlikely in any case (dark green) .....	11
Table 4 : Aircraft operational phases.....	13
Table 5 : Failure mode classification .....	15
Table 6 : Use of aircraft operator controlled PED and other PED .....	19
Table 7 : Potential interference issues and solutions .....	23
Table 8 : Evaluated wireless communication standards .....	44
Table 9 : Pulse, amplitude modulated standards .....	49
Table 10 : Radiated field, radiated power and resulting waveforms for pulse, amp. modulated standards .....	50
Table 10 (continuation) : Radiated field, radiated power and resulting waveforms for pulse, amp. modulated standards ...	51
Table 11 : FDMA/CDMA (CW-like) standards .....	54
Table 12 : Radiated field, radiated power and resulting waveforms for FDMA/CDMA (CW-like) standard.....	56
Table 12 (continuation) : Radiated field, radiated power and resulting waveforms for FDMA/CDMA (CW-like) standards ..	57
Table 13 : Comparison between required radiated power levels and test procedures .....	74
Table 14 : Default qualification levels for fly by wire aircraft.....	76
Table 15 : RF Radiated Susceptibility levels in the 300MHz - 6GHz band (Internal Transmitter Environment).....	77
Table 16 : Alternative qualification levels recommended by RTCA SC-202 for T-PED tolerant aircraft design.....	77
Table 17 : Example of qualification levels for Long Range aircraft equipment qualified between 1987 and 1992 .....	78
Table 18 : Example of qualifications levels for Long Range aircraft equipment qualified since 1998 .....	78
Table 19 : MEF / dB according to number of sources and minimal distance $d$ between them.....	82
Table 20 : Aircraft systems condition for interaction test.....	86
Table 21 : Limits for Human exposition to electromagnetic fields, according to [4].....	86
Table 22 : List of criteria to classify possible effect on aircraft systems .....	88
Table 23 : Test protocol – Summary .....	92
Table 24 : Qualification levels for the selected systems FADEC, FCS .....	93
Table 25 : Emission levels for Bluetooth, GSM and CDMA2000 .....	93
Table 26 : Resulting Safety Margin for the chosen standards.....	94
Table 27 : Selection of MEF for aircraft testing .....	95

## CHAPTER 1

### INTRODUCTION

#### 1.1 PURPOSE AND SCOPE OF THE DOCUMENT

This document provides general guidance for the use of Portable Electronic Devices (PEDs) and especially intentionally Transmitting Portable Electronic Devices (T-PEDs) inside an aircraft. ED-130 addresses authorities, airframers, aircraft system integrators and aircraft operators.

The existing policy prohibits the use of T-PEDs unless appropriate demonstrations have been made. Current regulatory policy restricts the use of PEDs and T-PEDs onboard aircraft on a basis that they could adversely affect operation of aircraft systems. In addition, recent popular publications have amplified the concern that mobile phones in particular could impact aircraft systems. The policies and the concerns are addressed in ED-130.

Consequently, ED-130 provides the processes to analyse and demonstrate electromagnetic compatibility (EMC) between PED or T-PED and aircraft electronics for general use of PED or T-PED. In addition, aircraft systems associated with the use of T-PEDs providing radio services new to the aircraft will require analogue EMC demonstrations regarding the T-PEDs intentional transmission and unintentional transmissions. This document describes therefore the processes and demonstrations to achieve operational approval for PEDs and T-PEDs.

ED-130 defines PEDs as portable devices that may be brought on board by crewmembers or passengers for entertainment and operational purposes or by operators and customers for example for cargo tracking. All devices are expected in the cabin, in the luggage compartments and in other accessible compartments of the aircraft. ED-130 distinguishes between PED and T-PED, which are under aircraft operators control and those, which are for example passenger owned and brought on board. The use of some PED is under control of the aircraft's operator. For operator controlled PED and T-PED the procedures and means to demonstrate EMC are different from those for passenger devices. ED-130 provides the guidance for both cases.

EUROCAE working group 58 has developed ED-130 in mutual consultation with RTCA SC 202. ED-130 focuses on electromagnetic interference aspects and operational guidance for the use of PEDs. The procedures and recommendations within ED-130 are compatible with those in RTCA DO-294A. In addition to DO-294A, ED-130 offers recommendations to accommodate qualification of aircraft systems that may be exposed to radio frequency emissions from T-PEDs or cabin wireless services. The DO-294A includes proposed FAR revisions to incorporate PED usage signage. For completeness, these are included in annex 8. It is proposed that aircraft operational regulatory bodies in Europe include analogous paragraphs in their regulatory requirements.

Interference to terrestrial communication networks and spectrum licensing is not addressed. Similarly, health concerns are not a subject of this document.

The technical content of this document is succinct for clarity. Most of the technical content necessary for the understanding of the document is given in ANNEXES. References are given for complementary technical data.

## 1.2 ORGANISATION OF THE DOCUMENT

The document is organised in three main sections following this introduction:

- Section 2 briefly describes the interference issues associated with the use of PEDs inside the aircraft, offering:
  - Main technical definitions,
  - Review of the origin of EMC issues, and
  - Review of interference issues and the conclusions established by the previous studies.
- Section 3 gives the current recommended practices for the use of PEDs:
  - The present PED policy is reminded,
  - The technical justifications of these recommended practices are given,
  - Recommendations about the application of these regulations are given,
- Section 4 describes a general procedure to ensure that no interference will be caused by the use of PEDs associated with radio services new to the aircraft. This procedure consists of EMC analyses tests for the installation of new equipment on board aircraft to minimize the risk of electromagnetic interference with the aircraft systems. Preliminary analysis, laboratory tests and aircraft measurements or tests are described.

This procedure is divided into three sections, dealing with different types of emissions caused by the devices under investigation (DUI):

- Intentional radiated emissions,
- Spurious radiated emissions,
- Spurious conducted emissions.

Section 4 describes only the main steps of the procedure. The ANNEXES give the complementary technical information necessary to fulfill the tasks recommended in section 4.

## 1.3 CAUTION

It must be highlighted that an electromagnetic interference is the result of several phenomena having a low probability of occurrence. All the possible configurations of the aircraft systems cannot be investigated, as well as the various coupling configurations. Therefore, the use of the given guidelines and procedures cannot guarantee that an interference will never take place, but will considerably reduce the risk of EMI occurrences.

## CHAPTER 2

### DESCRIPTION OF INTERFERENCE ISSUES

#### 2.1 PRESENTATION OF THE PROBLEM

##### 2.1.1 Portable electronic devices: definition

**Portable electronic devices (PEDs)** are typically lightweight consumer electronic devices, which are personally owned (passenger or crew-member) and personally operated and have functional capability for communications, entertainment, data processing, and/or utility. There are two basic categories of PEDs – those with and those without intentional transmitting capability.

PEDs with intentional transmitting capability, also called T-PEDs, include, but are not limited to cellular communication, wireless networking technology, hand-held radio transceivers, and transmitters that control devices such as toys. Some specific examples are mobile phones, citizen band radios, two-way pagers, Wi-Fi equipped laptops, Personal Digital Assistants (PDAs), and wireless gaming devices.

PEDs without intentional transmitting capability include, but are not limited to electric razors, basic laptops, basic electronic games, CD players, radios, etc. The passengers can take PEDs onboard for business and entertainment purposes. The PEDs can be operated by the flight attendants as their personal devices for their own usage, or as devices provided by the operator in order to help the flight or cabin crew in their tasks. They can also be a part of an aircraft installed system (examples are pico-cell and wireless local area network managing cells). In addition, the processes in this document apply to the EMC assessment of active RFID tags in aircraft, for example.

##### 2.1.2 Problem statement

PEDs, as any electronic devices, emit electromagnetic energy, either intentionally (useful signals for voice or data transmission) or unintentionally (spurious unwanted signals). This RF energy that may potentially be a source of interference:

- if it induces unwanted responses by direct coupling into an aircraft electronic equipment,
- if it falls in the frequency range of the communication and navigation systems.

In order to grant operational approval of PEDs and T-PED technologies for use onboard aircraft, the safe use of the PEDs or T-PEDs shall be demonstrated. With **safe use** is meant, “that cannot adversely affect the performance of the aeroplane’s systems and equipment” as stated in JAR OPS 1.110.

Therefore, the aim of the electromagnetic compatibility (EMC) analyses will be to ensure that no harmful adverse affect will be induced in the aircraft functions by the PEDs that will potentially be brought on board aircraft.

### 2.1.3 PED emission classification

The PEDs' radiated emissions can be divided into two categories:

1. Emissions that are non-intentionally emitted, and results from the internal electrical operation of the devices. These emissions represent energy that is wasted from the devices. They are also called spurious emissions.
2. Emissions that are intentionally generated by the devices. These emissions are useful signals with well-defined characteristics, emitted for communication and command purposes.

**All PEDs radiate low-level spurious emissions as a consequence of their internal electrical operation: laptop computers and CD players as well as mobile telephones and pagers.**

**Only T-PEDs (PEDs with transmitting capabilities) radiate intentional emissions additionally.**

If a connecting possibility exists to a power network or a local area network, the connected device also produces spurious conducted emissions that propagate along this connection.

The following figure summarizes the different emission types:

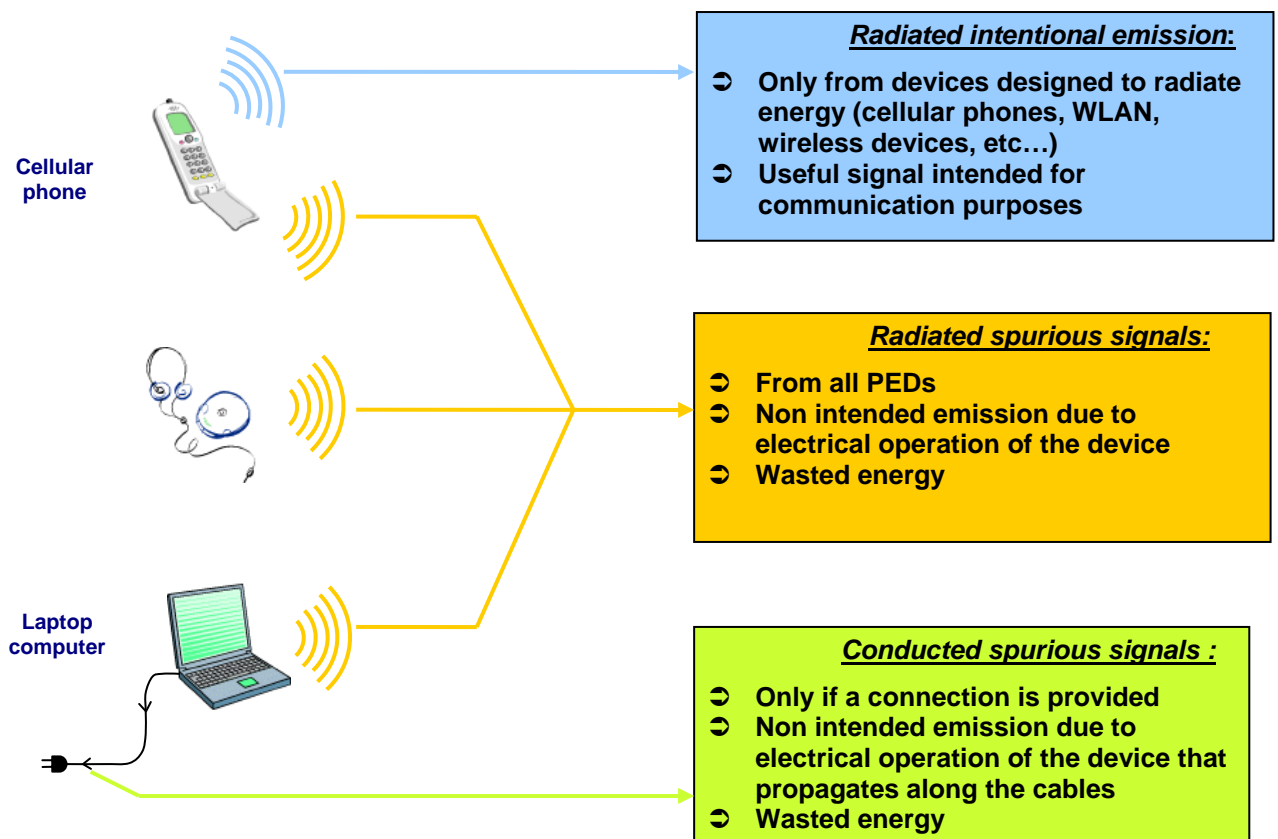

FIGURE 1 : EXAMPLE OF PED EMISSIONS

This figure indicates that the separation intentional / non-intentional transmitter is not totally adequate because any PED that uses electrical functions emits spurious emissions, and hence is also a non-intentional emitter.

Moreover, PEDs will more and more be fitted with RF transmitting capabilities for device communication, and data or voice transmission. Therefore, with respect to EMC analysis, it is indicated to focus more on the type of emission instead of the type of device or technology, and speak in terms of intentional emissions and non-intentional emissions. The main characteristics of the two emission types are summarized in the table below (see also [1], [3] and [7]).

Characteristics	Type of emission		Observations
	<i>Non- intentional emissions</i>	<i>Intentional emissions</i>	
<b>Frequency domain</b>	UNPREDICTABLE FREQUENCIES	PRECISE AND LICENSED FREQUENCY CHANNELS	Concerning the intentional emissions, the frequency channels are assigned by the national telecommunication authorities with respect to the other existing services
<b>Frequency bandwidth</b>	UNPREDICTABLE without measurement as the emissions may either be noise like or narrow band	DEPENDS ON THE COMMUNICATION TECHNOLOGY	Most of the spurious emissions from the PEDs are narrow band components. Exceptions are devices using non filtered electrical motors (toys, razors...) that emit broadband noise
<b>Waveform</b>	UNPREDICTABLE without measurement as the emissions may either be noise like or narrow band	DEPENDS ON THE COMMUNICATION TECHNOLOGY AND PROTOCOL	The T-PEDs use a large variety of waveforms and modulations. Most of these devices use CW signals with a variety of modulations. Several devices use pulsed like signals.
<b>Emitted level</b>	VERY LOW LEVEL	LARGE RANGE OF POWER LEVEL POWER CONTROL INCLUDED FOR DIGITAL DEVICES	The T-PEDs use a large range of power levels, generating typically 10 V/m at 1 m for a mobile phone, 3 V/m at 1 m for a wireless LAN. Spurious emissions levels are at least 30 dB lower than a typical WLAN intentional signal power level.
<b>Standard limits</b>	YES	YES	The standard limits, which are not all harmonized, give a value that the emissions must not exceed. This value could be exceeded however in the case of faulty devices, and due to the ageing of the devices (spurious emissions mainly). Sometimes also the device qualification is questionable.

**Table 1 : Main characteristics of intentional and spurious emissions**

### 2.1.4 The coupling paths

The coupling paths represent the different mechanisms for the emitted signals to couple to the aircraft systems. Concerning the radiated emission coming from PEDs, three coupling paths require investigation to assess the possibility of interference, as shown in Figure 2:

1. Coupling to radio-based equipment antennas.
2. Coupling directly to units (for radio and non radio based equipment).
3. Coupling to cables (power supply cables, data, video cables...).

Coupling of radiated emissions to antennas is called front door coupling, the interfering signal being out of band or within the receiver operational frequency band. This coupling takes place mainly through the doors and windows.

Direct coupling of radiated emissions to equipment units and cables is called back door coupling.

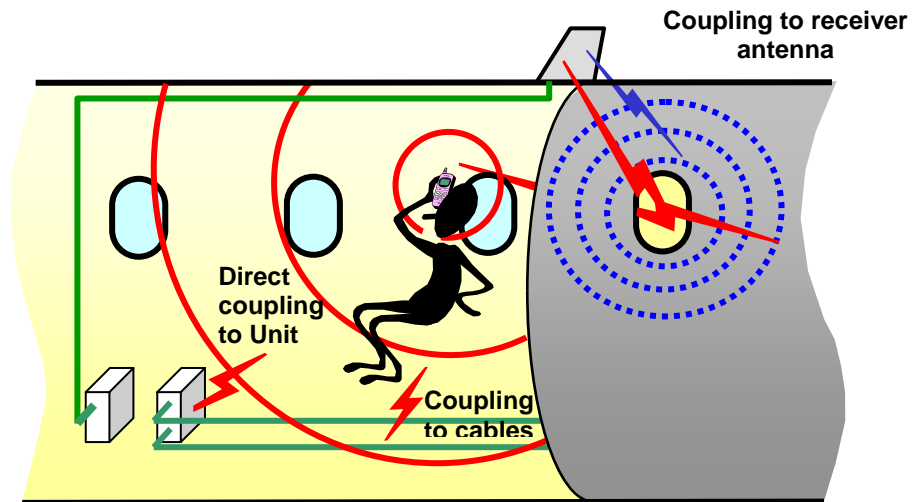

**FIGURE 2 : CONSIDERED COUPLING PATHS FOR RADIATED COUPLING IN ORDER TO ASSESS INTERFERENCE**

The potential interference via conducted coupling is restricted to the case where a cable connection between the device the aircraft exists. Examples are in-seat power supplies or integrated local area network connections, as shown in Figure 3.



**FIGURE 3 : CONDUCTED COUPLING TO AIRCRAFT WIRING**

### 2.1.5 Identification of the potential interference issues

Considering the different emission types previously described, and each identified coupling path, all the potential interference issues are described in the following table:

Threat from PED	Coupling Path	Nomenclature	Coupling type	
PED Emission type	Intentional Radiated emissions (useful signals)	Coupling through the radio based equipment <b>Antennas</b>	IRA	Front Door
		Direct coupling to equipment <b>Units</b>	IRU	Back Door
		Coupling to equipment input and <b>Cables</b>	IRC	Back Door
	Non Intentional Radiated emissions (spurious emissions)	Coupling through the radio based equipment <b>Antennas</b>	NIRA	Front Door
		Direct coupling to equipment <b>Units</b>	NIRU	Back Door
		Coupling to equipment input and <b>Cables</b>	NIRC	Back Door
	Conducted spurious emissions	Coupling to <b>Equipment Inputs</b>	CEI	Back Door
		<b>Cross Talk</b> coupling (cable to cable coupling)	CCT	Back Door

**Table 2 : Coupling paths and interaction scenarios to be investigated**

### 2.1.6 Acknowledgement of previous studies

Previous studies [1], [2], [6] and [7] have pointed out which interference cases are likely or unlikely to occur.

These analyses have been published within several reports, which references are given in the 0. The technical information and conclusions within these reports will be used as a basis for this document.

The basic principle of EMC analyses is shown in the figure below. For each potential interference issue, the emission levels for the source are compared to the immunity level of the potential victim equipment. This comparison is done through coupling values that characterise the path between the emitter and the aircraft victim equipment.

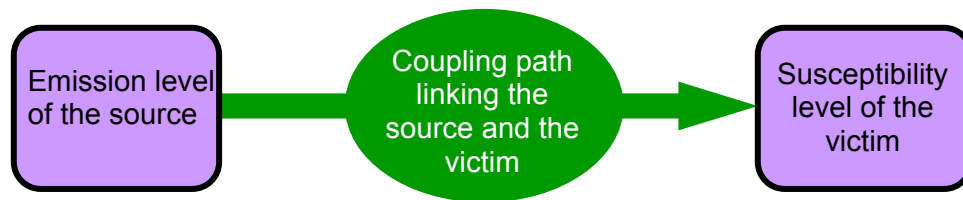

**FIGURE 4 : BASIC PRINCIPLE OF EMC ANALYSIS**

A summary of the main conclusions of the previous studies is given in this section according to the above-mentioned interference cases.



### 2.1.6.1 Front door coupling of radiated spurious emissions (NIRA)

**Within the operational band of the receivers**, the spurious emissions (noise or CW like signals) could potentially disturb the aircraft receivers if spurious signals couple to the antennas, because of two main reasons:

- Firstly, the receivers, in their operational frequency band, are designed to detect very low signals coming from the ground, and therefore are also sensitive to interfering signals in these bands, even signals of very low level.
- Secondly, the spurious emissions from PEDs can occur within the operational frequency band of the receivers.

In the majority of scenarios, spurious emissions affect the signal to noise ratio, resulting in the degradation or loss of the receiver function. Under several worst-case conditions however, an erroneous data interpreted as valid by the receiver could be generated. This could have hazardous consequences if it occurs in critical phases of the flight.

Nevertheless, this interference case needs an accumulation of worst-case conditions that is very unlikely [7]. Outside the operational band of the receivers, the signal rejection gives sufficient protection from the low level spurious signal coming from PEDs. As displayed in the figure below, the spurious signal could disturb the aircraft receivers, if the emissions fall within the receiver frequency band. Under worst-case assumptions, this interference case could have critical consequences for safety of flight.

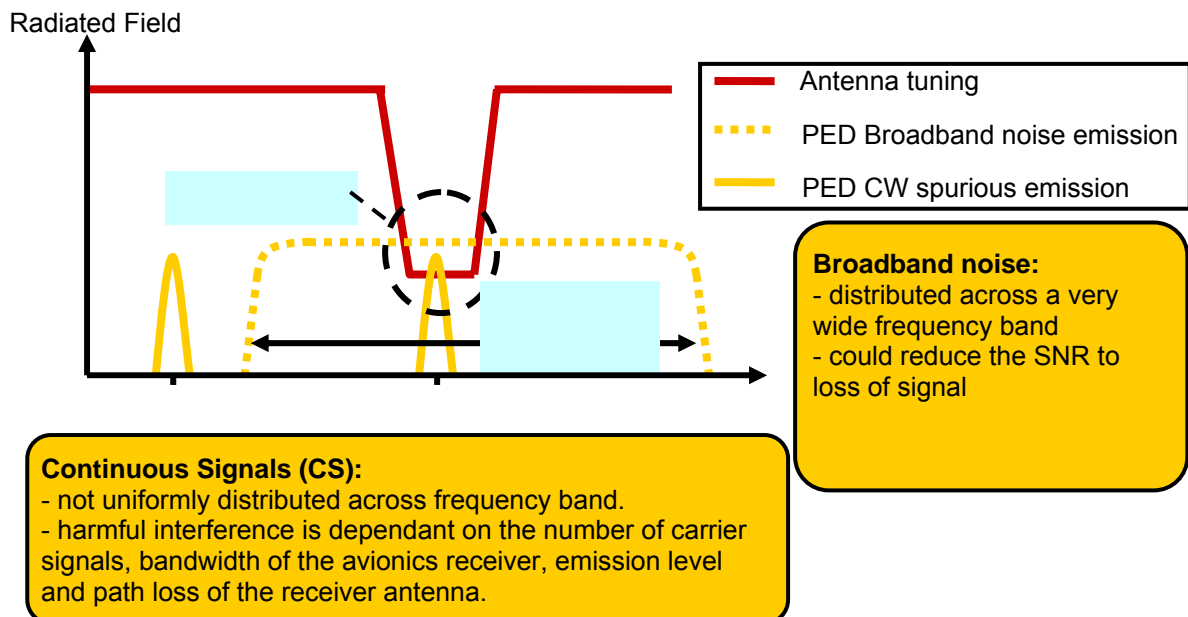

FIGURE 5 : FRONT DOOR COUPLING DUE TO RADIATED SPURIOUS EMISSIONS (NIRA)

### 2.1.6.2 Front door coupling of radiated intentional emissions (IRA)

The intentional emissions from T-PEDs occur in licensed frequency bands, allocated by the international and national telecommunication authorities.

The aeronautical radio navigation and communication frequencies are internationally harmonised and the telecommunication authorities ensure that no other RF service is assigned within these bands.

Therefore, there is a separation between the frequency bands used for aeronautical radio navigation and communication and those used by any T-PED not intended for aeronautical purpose.

⇒ **The frequency separation ensures that intentional emissions from T-PEDs CANNOT occur within the frequency bands used for aeronautical purposes.**

Figure 5 shows that the front door coupling of intentional T-PED signals occurs outside of the operational frequency band of the aircraft receivers.

As the receivers are well protected against interference outside their operational frequency band, interference is unlikely to occur. However, a strong signal could saturate the amplifier circuitry in the receiver if it is insufficiently protected against out of band signals. This interference case is also referred as “desensitisation”. This is very unlikely to happen since recent aircraft receivers are qualified to sustain severe out of band radiated environments.

⇒ **Receivers are well protected against out of band interference due to intentional emissions. For older receivers, there is a low probability that desensitization occurs.**

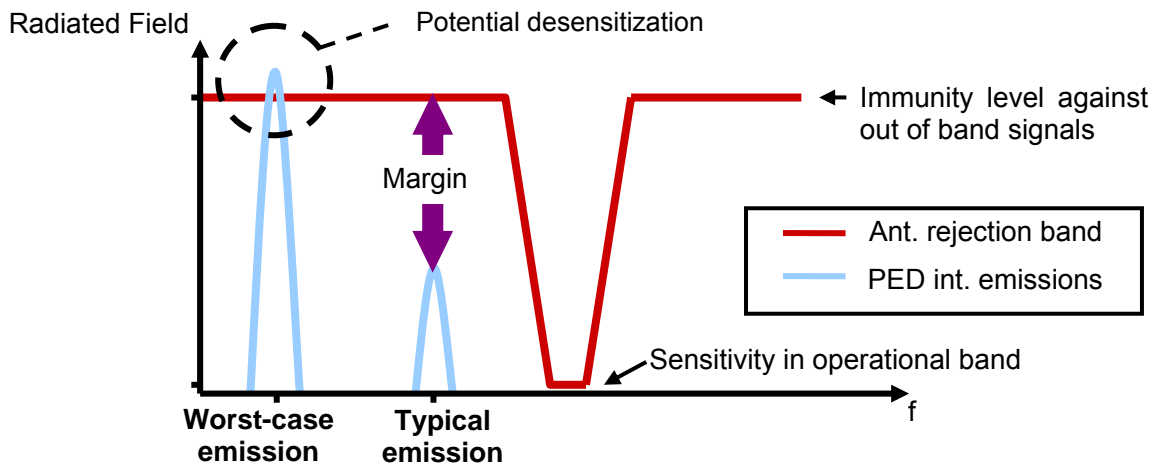

FIGURE 6 : FRONT DOOR COUPLING OF RADIATED INTENTIONAL EMISSIONS (IRA)

### 2.1.6.3 Back door coupling of radiated intentional and spurious emissions (IRU, NIRU, IRC, IRC)

The aircraft equipment units are protected against the effect of electromagnetic interference particularly against the high intensity radiated fields (HIRF) and the direct and indirect effect of lightning. Concerning the radiated fields and according to the equipment criticality and location, different qualification test levels are used, ranging typically from 1 V/m to 300 V/m.

For frequencies below 400MHz, it is considered that coupling (here IRC) into the interconnecting wiring may be significant. Hence, for these frequencies, the spurious signal coupled onto the wiring can be directly compared to the functioning signal of the equipment unit. Above that frequency IRC occurs mainly at the last few centimetres of the interconnection wiring, at the interface connection plug and inside the unit. The T-PED considered here all operate at frequencies above 400 MHz.

Spurious emissions generally produce radiated fields of very low level, typically less than 0.1 V/m at 1 m distance. The spurious emissions from a mobile telephone are typically more than a thousand times lower than the useful signal generated by the telephone to establish the communication.

- **Non-intentional emissions are no threat for direct coupling to the equipment via cases or wiring.**

T-PED's intentionally emitted electric field strengths may be higher than some aircraft equipment low qualification levels, for example categories S and T out of ED-14D/E, section 20.

- **Intentional emissions could potentially disturb aircraft equipment by direct coupling through the equipment cases or cables, depending on the emitter location and power level. However, HIRF qualified critical equipment units are well protected against EMI and are very unlikely to be disturbed.**

Figure 7 illustrates back door coupling (coupling of radiated emissions to units or cables)

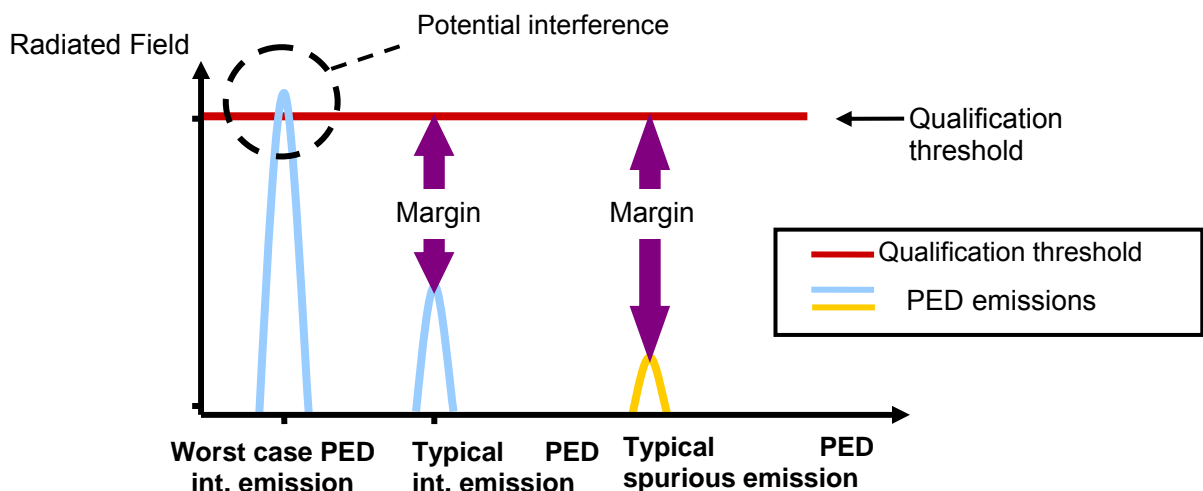

FIGURE 7 : BACK DOOR COUPLING OF RADIATED EMISSIONS (IRU, NIRU, IRC, IRC)

#### 2.1.6.4 Interference from conducted signals

Concerning interference from conducted spurious signals from a passenger device (in the case of a physical connection); such interference is considered unlikely because of several reasons:

- The aircraft network (power or local area network) to connect a PED is separated from other aircraft electrical networks,
- This network shall be provided with EMI filters,
- The aircraft equipment is protected against higher interfering conducted signals than the low level spurious emission from PEDs.

As direct conducted interference from spurious signals is not considered to be an issue, the cross talk coupling (conducted spurious signals that couples to a nearby cable) is not considered as a threat either, due to the low levels of the interfering signals involved, and the cable shielding that will limit the coupling. However, in the case of installed equipment, the conducted interference must be studied as a normal part of the installation procedure of new equipment. Therefore, the interference possibility depends only on the proper design of the dedicated network.

#### 2.1.6.5 Remaining issues and conclusions

From these observations, the following interference case table can be completed:

PED interference scenario	Coupling path	Nomenclature	Coupling type	Conclusions from previous studies	
PED Emission type	Intentional Radiated emissions (useful signals)	Coupling through the radio based equipment Antennas	IRA	Front Door	Interference is unlikely due to frequency separation of services
		Direct coupling to equipment Units	IRU	Back Door	Interference is possible Only non essential equipment could be impacted
		Coupling to equipment input and Cables	IRC	Back Door	Interference is possible Only non essential equipment could be impacted
	Non Intentional Radiated emissions (spurious emissions)	Coupling through the radio based equipment Antennas	NIRA	Front Door	Interference is unlikely but possible Interference might be more critical in certain phases of flight
		Direct coupling to equipment Units	NIRU	Back Door	Interference is unlikely in any case
		Coupling to equipment input and Cables	NIRC	Back Door	Interference is unlikely in any case
	Conducted spurious emissions	Coupling to Equipment Inputs	CEI	Back Door	Interference is unlikely in any case if the networks are adequate
		Cross Talk coupling	CCT	Back Door	Interference is unlikely in any case if the networks are adequate

**Table 3 : Potential interference issues, completed with the previous studies' conclusions Red: interference can happen and could have serious consequences Yellow: interference can happen and could have only minor consequences Green: Interference is unlikely (light green), unlikely in any case (dark green)**

The most probable interference issues to the aircraft systems come from:

- The coupling of radiated spurious emissions to the antennas (NIRA)
- The coupling of intentional radiated emissions to the equipment units (IRU)
- The coupling of radiated emissions to cables (IRC)

Only the first of these three coupling issues could result in significant reduction of safety margins or significant increase in crew workload. For each of these coupling cases the possibility of interference has been demonstrated. However, the probability of these coupling issues is very difficult to establish. In general, definitive conclusions cannot be given because of the great variety of PED devices and of aircraft type, with a variety of emissions levels and immunity levels. Only partial conclusions, applying to precise categories of aircraft, can be deduced from the analyses. To reduce the risk of interference to an acceptable level, operational rules for the use of PED have been established, consisting mainly of the prohibition of the use of PEDs in several phases of the flight with differences between PEDs and T-PEDs. These prohibitions are valid unless the use of these devices has been demonstrated to have no adverse effects on the operation of the aircraft. The aim of the following sections is hence:

- To review the recommended practices for the use of PEDs, give justification for them and recommendations for application (Section 3),
- To give guidance for the additional operational approval that would allow operating PEDs and T-PEDs without these prohibitions (Section 4).

## CHAPTER 3

### CURRENT PED RECOMMENDED PRACTICES

#### 3.1 DEFINITION OF PHASES OF OPERATION

The rules for using the PEDs brought on board aircraft are dependent of the standard operational phases of flight. A definition of these phases of flight is given in the Table 4.

Operational Phase	Definition
Park/Gate	On-ground, aircraft stationary/parked
Taxi-Out	Taxiing between Park/Gate position and active runway
Departure	Entering active runway, take-off and climb out operations below 10,000 feet
Cruise	Flight altitude above 10,000 feet
Arrival	Approach and descent operations below 10,000 feet, landing and exiting active runway
Taxi-In	Taxiing between active runway and Park/Gate position

**Table 4 : Aircraft operational phases**

**For the purposes of this section, critical phases of flight include all operations involving taxi, take off and landing, and all other flight operations conducted below 10,000 feet, with the exception of parking.**

#### 3.2 EASA GENERAL REQUIREMENT

The *European Aviation Safety Agency* (EASA) published Certification Specifications (CS) binding for all EU-(European Union)-member states containing the requirements regarding the use of PEDs.

The CS is based on JAR (Joint Aviation Requirements) that are adopted by the JAA (Joint Aviation Authorities) member states. The PED requirements are given within JAR OPS Part 1.

JAR OPS 1.110 states that: "An operator shall not permit any person to use, and take all reasonable measures to ensure that no person does use, on board an aeroplane, a portable electronic devices that can adversely affect the performance of the aeroplane's systems and equipment".

Therefore and considering the potential interference issues identified in Chapter 1, appropriate measures must be used to ensure that the interference risk is the lowest possible.

#### 3.3 PED REQUIREMENTS

The requirements regarding type of equipment and operational phase of usage can be found in individual national regulations. The JAA guidelines can be found in the JAA Temporary Guidance Leaflet (TGL) No.29 [5]. The US American requirements are defined in the FAA Advisory Circular (AC) No. 91.21-1A.

### 3.4 PED RECOMMENDED POLICY

The general policy of some airlines concerning the use of PEDs by passengers is that all PEDs must be completely switched off once the aircraft doors are closed before the start of the flight. Then according to the phase of the flight, the use of PEDs is tolerated. Unless the demonstration has shown that the device can be operated with no adverse effects on the aircraft systems' functions, or specifically:

- **The use of any passenger PED is prohibited during the most critical phases of flight: departure and arrival.** Non intentionally transmitting PEDs should remain completely switched OFF, and should be stowed and disconnected from any in-seat power supply during taxi, take-off, approach, landing and during abnormal or emergency conditions:
  - This restrictions apply to the devices carried onboard or provided to the passengers,
  - At the aircraft commander's discretion, the use of PEDs may be permitted when the aircraft is stationary,
  - A WPAN device conforming to the "Bluetooth" standard may be handled in the same manner as a non intentionally transmitting PED.

**NOTE:** *Some PEDs such as watches, hearing aids, heart pacemakers and other medical devices have already been demonstrated and are allowed (see Annex 1.3.10)*

- **The use of any passenger intentional emitter (T-PEDs) is prohibited during any phases of the flight.** Intentionally transmitting PEDs should remain completely switched OFF until the end of the flight when a passenger door has been opened.
  - At the aircraft commander's discretion, the use of T-PEDs may be permitted when the aircraft is stationary,
  - This restriction does not apply to a PED compliant with the "Bluetooth" Standard.
- **The PEDs provided to assist the flight crew in their duties should be used in accordance with the Operations Manual and are under control and responsibility of the aircraft operator. These PEDs will need to be switched off and stowed during all phases of flight** unless:
  - Tests have been performed which confirm that these PEDs are not a source of unacceptable interference for the aircraft electronics or cause a distraction. This has to be ensured by the operator.
  - The PEDs do not pose a loose-item risk or other hazard,
  - The conditions for their use in flight are stated in the Operations Manual.
- **PEDs provided to assist cabin crew in their duties should be switched off and stowed during critical phases of flight,** unless tests confirm that these are not a source of interference or other safety hazard.

This PED policy is completed by a list of the allowed devices according to the phases of the flight that can be found in Annex 1.

### 3.5 TECHNICAL SUBSTANTIATION

#### 3.5.1 Aim of the PED policy

As previously stated, the most probable interference issues to the aircraft systems come from:

- The coupling of non intentional, radiated spurious emissions to the antennas (NIRA)
- The coupling of intentional, radiated emissions to the equipment units (IRU)
- The coupling of intentional, radiated emissions to cables (IRC)

The aim of the PEDs policy must be to minimise the interference risk from these cases to the lowest possible value, and that no adverse affect is caused by PEDs, without taking unrealistic measures.

#### 3.5.2 Spurious emissions from PED not under operator control (NIRA)

As explained in the section 2, the previous worst-case analyses ([7], [2]) have shown that there was a possibility of interference due to the spurious emissions from PEDs to communication and navigation receivers.

The receivers most sensitive to this interference are ILS (Localiser and Glide slope), VOR, VHF and HF communication, GPS and MLS.

As shown in the table below for a sample of receivers, only the occurrence of interference during approach, the take off and landing phase could result in more than minor failure consequences.

Receiver	Flight phase	Failure mode	Classification
VHF	Take off / Landing	Interference on 1 channel	Major
VHF	Cruise	Interference on 1 channel	Minor
VOR	Take off / Landing	Loss or fluctuation of VOR bearing	Major
VOR	Approach	Loss or fluctuation of VOR bearing	Major
VOR	Cruise	Loss or fluctuation of VOR bearing	Minor
ILS-LOC	Take off / Landing	Generation of stable erroneous indications	Catastrophic
ILS-LOC	Take off / Landing	Loss or fluctuation of LOC bearing	Hazardous
ILS-LOC	Approach	Loss or fluctuation of LOC bearing	Hazardous
ILS-LOC	Cruise	Loss or fluctuation of LOC bearing	Not applicable

**Table 5 : Failure mode classification**

In most of the cases, the behaviour of the receivers remains safe, because the receiver checks the integrity of the received signal. However, one interference scenario could result in critical failure conditions (safety impact): the generation of false information interpreted as valid on a receiver needed for landing operations such as the ILS Localizer or Glide slope. The probability of these interference is low, because interference requires that a PED located in a “worst case” location emits a significant spurious emission that falls precisely in the operational frequency band of the receiver.

As an example, the critical interference scenario of an **erroneous data** generated in the ILS receiver requires that:

1. A PED is emitting (intentionally or unintentionally turned on) during the critical phase of flight,
2. This PED emits a spurious component CW component near or above the standard limit for radiated emissions,



3. This PED is located in a worst case position for interference to ILS, such as in the cockpit or close to the doors of the aircraft,
4. The CW spurious component from this PED falls within the one of 40 ILS frequency channels that corresponds to the active runway,
5. The CW spurious component from this PED falls precisely within the 40 Hz susceptibility window inside the frequency channels of the ILS but outside the side bands of the ILS signal,
6. The CW spurious component from this PED is a stable, low frequency modulated CW signal (modulation frequency below 1 kHz).

The occurrence of these six conditions simultaneously is very unlikely.

However; the precise interference risk is impossible to determine, due to the lack of measured data concerning spurious emissions from PEDs and the large number of aircraft configurations to consider [7].

Moreover, the risk analyses undertaken in the previous studies [7] did not demonstrate a sufficient confidence concerning the interference risk during the departure and arrival phases of the flight.

➤ **In order to prevent the possibility of interference during departure and arrival, all PEDs should be turned off during these critical phases of the flight.**

This operational rule cannot prevent a device from being unintentionally turned ON or left ON during the critical phases of the flight. Nevertheless, the interference risk -- that was already low -- is considered to be reduced to an acceptable value. These operational rules correspond to the best practices to adopt to reduce the risk to the minimum.

During the cruise phase of the flight, an eventual interference would have only minor consequences on the aircraft operations. These consequences can be handled by the flight- and cabin-crews. Moreover, the probability of such interference is low.

➤ **During the cruise phase of the flight, the use of PEDs can be tolerated, provided that the aircraft Captain can always order that all devices are turned off if interference is suspected.**

### 3.5.3

#### **Intentional emissions from PED not under operator control (IRU, IRC and IRA)**

Due to the fact that the critical and essential systems are well protected against the electromagnetic interference, only non-essential systems could be impacted. Hence, the consequence of backdoor interference from usual passengers' T-PEDs (excluding powerful two way radios) on aircraft systems would be minor, and could be managed by the crew.

However, the probability of interference could be higher than for interference to receivers if intentional transmitters are operated close to equipment qualified to low levels. The repetitive occurrence of interference could increase the crew workload and degrade the perceived quality of the aircraft.

➤ **In order to avoid these interference cases, the intentional transmitters should be turned off during the entire duration of the flight.**

The potential interference due to an intentional transmitter that was unintentionally left turned ON to a non-essential system is considered to be unlikely and manageable by the crew.

### 3.5.4 Portable electronic devices under control of the aircraft operator

For spurious emissions of aircraft systems, an accepted means of compliance is the qualification against the standard ED-14/DO160 section 21.

A PED without radio transmitter functionality under operator control, which is qualified against ED-14D/DO-160D or ED-14E/DO-160E section 21, radiated emission limit Cat. H, would usually be considered appropriate for operation during all flight-phases from the electromagnetic compatibility point of view.

A T-PED under operator control, which is qualified against ED-14D/DO-160D or ED-14E/DO-160E section 21, radiated emission limit Cat. H. would usually be considered appropriate for operation during all flight-phases from the electromagnetic compatibility point of view.

For T-PED the emissions at the operational frequency may, for functional purposes, exceed the Cat. H spurious emissions limit, if in addition it is demonstrated that the T-PED technology does not interfere with the aircraft electronic systems. This demonstration can be based on the aircraft's electronics qualification or the EMC demonstration process described in this document (see section 4.2).

For all points above review with the appropriate regulating authority or agency will be necessary.

For the potential use of UWB broadband communication technology, which transmits at a very low noise level, potentially within the navigation and communication bands, an additional demonstration of compatibility is mandatory but **not covered** by the procedures within this document, because the associated standard is not finalized at the time of publication of ED-130. Additional background information, but not the EMC demonstration guidance for time-domain broadband technologies, can be found in ED-118.

### 3.5.5 In flight experience

The in flight experience gathered since the existing PED policy has been in application allows reaching several conclusions.

- Today, according to a Consumer Electronic Association (CEA) survey, 76 % of the passengers have already carried on board one or more PEDs, and at least 40 % of the passengers have already used a PED during a flight. The handheld electronics market indicated a major growth over the last decade
- Although there have been reported events of interference, the evolution of the number of events over the last decade shows that the number of reported events is **not correlated** with the increase of the number of PEDs among the passenger population, and that interference issues were reported mostly on older aircrafts. ([1], Appendix 6A, ASRS database)
- Generally, among the reported events, the suspect system behaviour could be acknowledged as a possible PED interference in only less than 1% of the cases. In more than 90 % of the cases, the suspect system behaviour was caused by an aircraft component malfunction or known software bug (Lufthansa analysis summarised in the Appendix 6.B of [1], Airbus and Boeing in flight experience)

This in flight experience indicates that the interference issue of spurious emissions is today adequately managed. The question raised by the current PED policy is: "Have the potential interference issues been adequately managed until now?"

Current regulatory policy restricts the use of PEDs and T-PEDs onboard aircraft on a basis that they could adversely affect operation of aircraft systems. Recent popular publication of the Carnegie Mellon report [20, 21] has amplified public concern that mobile phones in particular could impact aircraft systems. The Carnegie Mellon University study [21] indicates that there are more and more mobile phones unintentionally left on during flight. While the report does not correlate a single event with PED operation onboard aircraft it highlights the fact that mobile phones are transmitting on aircraft on a daily basis. As a consequence this document recommends:

- That transport aircraft should be assessed for immunity in accordance with Chapter 4.
- Signage and passenger briefings should follow the recommendation of annex 8 for operational guidance

### **3.6 RECOMMENDATION FOR APPLICATION OF THE PED POLICY**

#### **3.6.1 Announcements**

In order to apply the recommended policy, it is considered that an appropriate use of passenger announcements is sufficient.

The announcements shall be harmonised between companies and aircraft, and be formulated in a clear and understandable way.

The announcements should be made prior to and during boarding so that passengers may be reminded of the restrictions applicable to mobile phones and other transmitting devices.

#### **3.6.2 Action and awareness of cabin crew**

The cabin crew must observe the intentional transmitter usage restrictions concerning their own personal devices.

The cabin crew should monitor passenger use of equipment during the flight and, where necessary, ensure that suspect equipment is switched off.

The cabin crew should be particularly alert to passenger misuse of equipment that has a built-in transmitting technology.

The flight to cabin crew co-ordination to deal with interference or other PED safety related problems should be increased.

The crew should be aware of the proper means to switch off in-seat power supplies.

#### **3.6.3 Flight phases cruise, take off and landing**

In general the use of uncontrolled, i.e., crew or passenger owned, PED or T-PED shall be restricted to the cruise phase.

In general the use of PED or T-PED during non-cruise phase shall be limited to:

1. T-PED technologies which are known not to interfere with the aircraft's NAV/COM systems
2. T-PED and PEDs which are under the operators control and which are qualified against applicable emission standards such as ED14D,E/DO-160D,E section 21, Cat. H.

Both conditions are mandatory for use of T-PED or PED during Take-Off and Landing.

During the flight, if turbulence is encountered, loose items that are not safely fixed and that could represent a hazard, should be properly stowed.

For flight phases Taxi-in, Taxi out, Stationary Aircraft the following recommendations apply.

### 3.6.4 Flight phases taxi in, taxi out, stationary aircraft

It is left to the operator's discretion, and finally at the aircraft commander's discretion, if the use of T-PEDs may be permitted when the aircraft is stationary, or during taxi in and taxi out when the aircraft has left the active runway.

The operator shall have considered and applied the aircraft manufacturer's guidance material such as service information letters or comparable instructions.

PED restrictions could be applied in the pre-departure briefings to be given the maximum of attention by the passengers.

All these recommended practices are summarized and shown according to the flight phase in the following table and in Figure 8:

Type	PED control type	Restrictions	Procedure to apply	Page
PED	Aircraft operator controlled devices	Can be allowed in all flight-phases	Qualify against ED-14D/E, DO-160D/E, sec. 21, cat H see section 3.5.4	-
	Passenger devices or uncontrolled devices	To be allowed only during cruise phase only  May be used at the Gate and during parking if allowed by the pilot. See figure 8.	-	-
T-PED	Aircraft operator controlled devices	Can be allowed in all flight-phases	Qualify against ED-14D/E, DO-160D/E, sec. 21, cat H (see section 3.5.4)  EMC validation process section 4.2	-  30
	Passenger devices or uncontrolled devices	To be allowed only during cruise phase only  May be used at the Gate and during parking if allowed by the pilot. See figure 8	EMC validation process section 4.2	30

**Table 6 : Use of aircraft operator controlled PED and other PED**

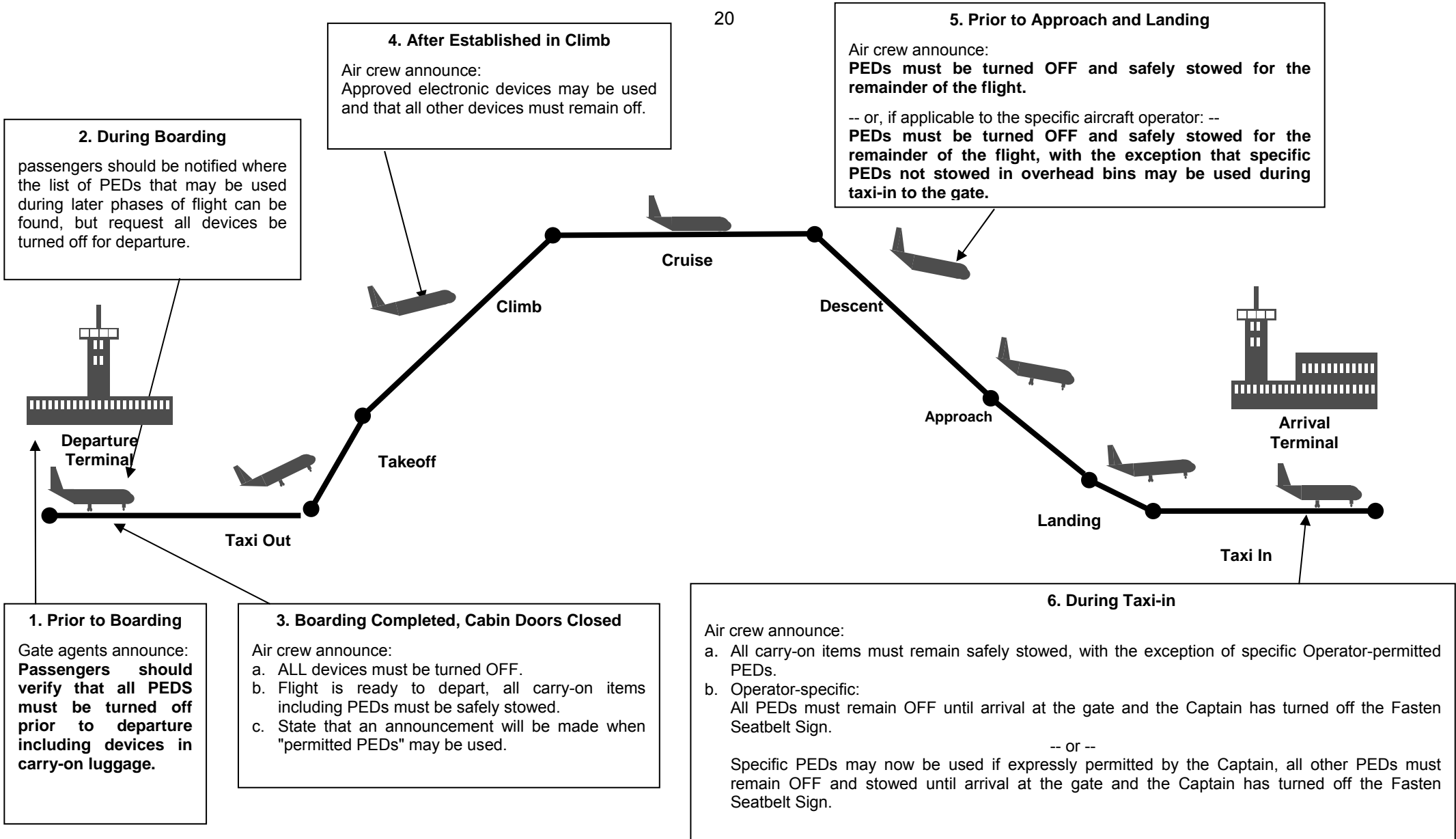

FIGURE 8 : RECOMMENDED CONTENT AND TIMING OF ANNOUNCEMENTS REGARDING PERMITTED USE OF PEDS / T-PEDS

### 3.6.5 Reporting

Despite all the precautions concerning the in-flight use of PED, some adverse effects may be noticed once in operation, for example with a very specific configuration of the PED or for example also after a change of a NAV/COM receiver unit (installation of a more sensitive one).

Whilst operators are invited to report occurrences connected with PED usage to the responsible authority of suspected or confirmed interference, certain regulatory authorities or agencies operate Occurrence Reporting systems that would mandate such reporting. The report shall be as precise as possible.

### 3.6.6 Long-term recommendations

To avoid misunderstandings with flight and cabin crew requests, passengers should be given information in clear and unmistakable language of an operator's PED policy in advance of travel.

An effective public awareness campaign should be developed and coordinated through concerned international bodies such as IATA and CEA. It should be broad and it should reach all sectors of the flying public, various Medias could be used for this purpose.

The In-flight magazines provided by the Airlines as a courtesy to the passengers in the seat pockets should include a section with detailed information regarding the PED policy for the Passengers. Other publications, where reference should be made to the PED Policy are:

- Safety briefing cards,
- Ticket cover,
- Regular customer mailings.

At the aircraft level, the installation of a highly visible notification light to clearly indicate if the T-PED use is allowed at the given time of the flight should be considered. This may especially be needed for T-PED transmitting more than 100mW (see chapter 4.2.1.2.). Many low power devices, transmitting less than 100mW such as Bluetooth, are already justified and may be used in non-critical phases of flight, see ref 2, 5, 10. The signage would improve the communication from the cockpit to the cabin for clearly indicating the attainment of cruise flight status (e.g., "No Electronic Devices" symbol instead of the existing "No Smoking" signs). An example is displayed in the next figure:



**FIGURE 9 : EXAMPLE FOR "NO ELECTRONIC DEVICES" SIGNAGE**

The logic should be analyzed to address any safety analysis identified concerns

Coordination with the handheld electronics concerned bodies should be developed in order to set up harmonized recommended practices concerning intentional emitters. For example, these harmonized practices could be used to address:

- A consistent and easily identifiable indicator for the "transmitter disabled" state for T-PEDs (Flight mode etc...),
- The ease of turning off all transmitting functions in T-PEDs,
- An associated terminology used to convey information about T-PEDs, device operation and state, and passenger use

## CHAPTER 4

### GUIDANCE FOR THE OPERATIONAL APPROVAL OF T-PED TECHNOLOGIES NEW TO THE AIRCRAFT

#### 4.1 PURPOSE AND SCOPE OF THE PROCEDURE

The procedure described in this section should be used when the operators intend to use or allow the use of a PED or T-PED technology new to the aircraft outside the current PED policy. Unless the appropriate demonstrations have been done, the present PED policy, section 3.4 prohibits:

- The use of mobile intentionally transmitting devices (T-PEDs),
- The use of any PEDs during critical phases of the flight.

The purpose of the present procedure is to define the appropriate demonstration for the use of intentionally transmitting mobile devices outside the critical phase of flight. This section is dedicated to the process to follow in order to demonstrate that the T-PED technology has no adverse effects on the aircraft. The demonstration procedure provides recommended analyses and tests that will demonstrate that the new T-PED technology will not interfere with the aircraft equipment.

These analyses and tests done shall be presented to the Airworthiness Authorities to be validated before the T-PED technology can be used on board the aircraft.

This procedure does not cover the electromagnetic protection of the T-PEDs themselves. In addition it is not meant to demonstrate the proper function of the T-PED technology. Protection against external threats (HIRF and Lightning) is not covered in this document.

The procedure is divided into three parts:

1. The first part (**Part 1** – section 4.2) is applicable, if the devices to be used are intentional field transmitters. This part describes the analyses and tests to conduct in order to ensure that no adverse effects occur due to the back door coupling of intentional radiation to units and cables:
2. The second part (**Part 2** – section 4.3) is applicable to any kind of device, and covers unintentional field radiations from T-PED or PED.
3. The third part (**Part 3** – section 4.4) is applicable to any kind of device and covers unintentional conducted emissions from T-PED or PED.

An appropriately qualified EMC engineer should conduct and support the execution of these procedures. The operator may subcontract some or all of the tasks to qualified subcontractors, if necessary.

EMI issues according to definitions from sections 2.1.4, 2.1.5 and 2.1.6 are summarized in Table 2 and Table 3. Table 7 provides an overview and summary of presently accepted and existing risk mitigation practices and immunity demonstrations.

Threat from PED		Potential coupling path	Nomenclature	Coupling type	Solution to date
PED Emission type	Intentional Radiated emissions (useful signals)	Coupling through the radio based equipment <b>Antennas</b>	IRA	Front Door	Combined back door testing Out-of-band susceptibility analysis from MOPS
		Direct coupling to equipment <b>Units</b>	IRU	Back Door	Combined back door testing Radiated susceptibility Qualification level compared with emissions from T-PED
		Coupling to equipment input and <b>Cables</b>	IRC	Back Door	Combined back door testing Not to be considered above 400MHz as included in radiated susceptibility test Conducted susceptibility level compared with T-PED's coupled current on wiring
	Non Intentional Radiated emissions (spurious emissions)	Coupling through the radio based equipment <b>Antennas</b>	NIRA	Front Door	Prohibition of using unqualified PEDs during critical phase of flight
		Direct coupling to equipment <b>Units</b>	NIRU	Back Door	Not an issue. No further consideration
		Coupling to equipment input and <b>Cables</b>	NIRC	Back Door	Not an issue. No further consideration.
	Conducted spurious emissions	Coupling to <b>Equipment Inputs</b>	CEI	Back Door	No connection to T-PED. If connection to onboard power supply then it is an issue of EMC with this power supply and therefore a matter of spurious signal rejection at the input. Filtering solves this today. The wireless transmission has no EMI impact.
		<b>Cross Talk</b> coupling	CCT	Back Door	T-PED cabling cross talk is not different from PED cabling cross talk. The wireless transmission has no impact. No further consideration necessary

**Table 7 : Potential interference issues and solutions**

The potential interference from T-PEDs with any aircraft system depends on several parameters: emission power, frequency band of emissions, victim vulnerability, and how energy is actually coupled. The origin of the coupled emissions of concern can be from the T-PED's antenna, external wiring or unit enclosing the processing circuitry.

Table 7 provides guidance as to which immunity demonstrations against threats from T-PED should be performed. For intentional radiation, a back door coupling test, as described in ANNEX 5 and ANNEX 6 using the test signals defined in ANNEX 2, will include effects due to IRA front door coupling too. Therefore, all intentional radiated effects can be identified via back door testing inside the A/C.

A different situation takes place when dealing with non-intentional radiations. Their evaluation is more difficult, because these are unwanted, low level out-of-band emissions from T-PEDs and may be in-band emissions for the aircraft receivers. This coupling situation is called non-intentional radiation to antennas (NIRA). For NIRA refer to 4.3, where the assessment requires the consideration of flight phase.



NIRU and NIRC are not an issue to any foreseeable technology since the radiated levels even at the closest distances ( $\sim 0.1$  m), are much less than 1 V/m or 0.1 V/m, which are the lowest qualifications levels defined by qualification standards ED-14/DO-160A and B. Newer versions of ED-14/DO-160 provide higher levels, which have to be selected against aircraft protection requirements. Hence, modern equipment qualified against any category of ED-14 C,D,E / DO-160 C,D,E section 20, cannot be affected by spurious emissions regarding backdoor coupling. The remaining coupling paths require a physical connection to aircraft wiring. Coupling to equipment inputs (CEI) is an airframe integration issue. In general interfaces are protected with the help of adequate filtering. For further details on this issue check section 4.4. CCT is not different from the present situation and independent from wireless technology.

#### **4.1.1 Use of operator controlled intentionally transmitting devices**

The procedure applies to any intentionally transmitting device under control of the operator. The crew may for example operate them. The aim of the applicable procedure according to figure 10 is to demonstrate that the intentional transmissions from the device will not cause interference to the aircraft systems.

Operator-controlled devices may be intended for use in all flight phases and not restricted to the cruise phase only. This includes both PEDs and T-PEDs.

If the T-PED is part of a service based on radio communication between the aircraft system and T-PED, the aircraft system and the T-PED's radio technology must not produce adverse effects with the overall aircraft electronics. Examples for such situations are wireless local area network (WLAN) services using aircraft-installed access-points or onboard mobile telephony systems using for example pico-cells. The aircraft installed portion of the system must be qualified as any other aircraft equipment. The compatibility of the radio transmitter technology with the aircraft in general can be demonstrated with the help of the processes within this document, especially section 4.2.

The installation of the aircraft wireless systems part shall be in line with the installation procedure given by the aircraft manufacturer or owner of the supplemental type certificate.

For spurious emissions to aircraft systems, an accepted means of compliance is the qualification against the standard ED-14D/DO-160D or ED-14E/DO-160E section 21.

A PED or T-PED, which is qualified against DO-160D or DO-160E section 21, radiated emission limit Cat. H, may be operated by the crew during all flight-phases from the electromagnetic compatibility point of view. The EMC validation process for T-PEDs is described in section 4.2.

#### **4.1.2 Use of intentionally transmitting devices not under operator's control**

This section addresses the use of devices, which are not under control of the aircraft operator. These are for example passenger owned devices. Both types, PED and T-PED, are to be allowed during cruise phase only. However, the devices may in addition be used at the gate if allowed by the pilot.

The EMC validation process for a T-PED is described in section 4.2. For spurious emissions and conducted emissions refer to section 4.3 and 4.4 respectively. A summary of the demonstration process for passenger devices is shown in Figure 10.

4.1.3

Overview: the procedure and associated sections in the document

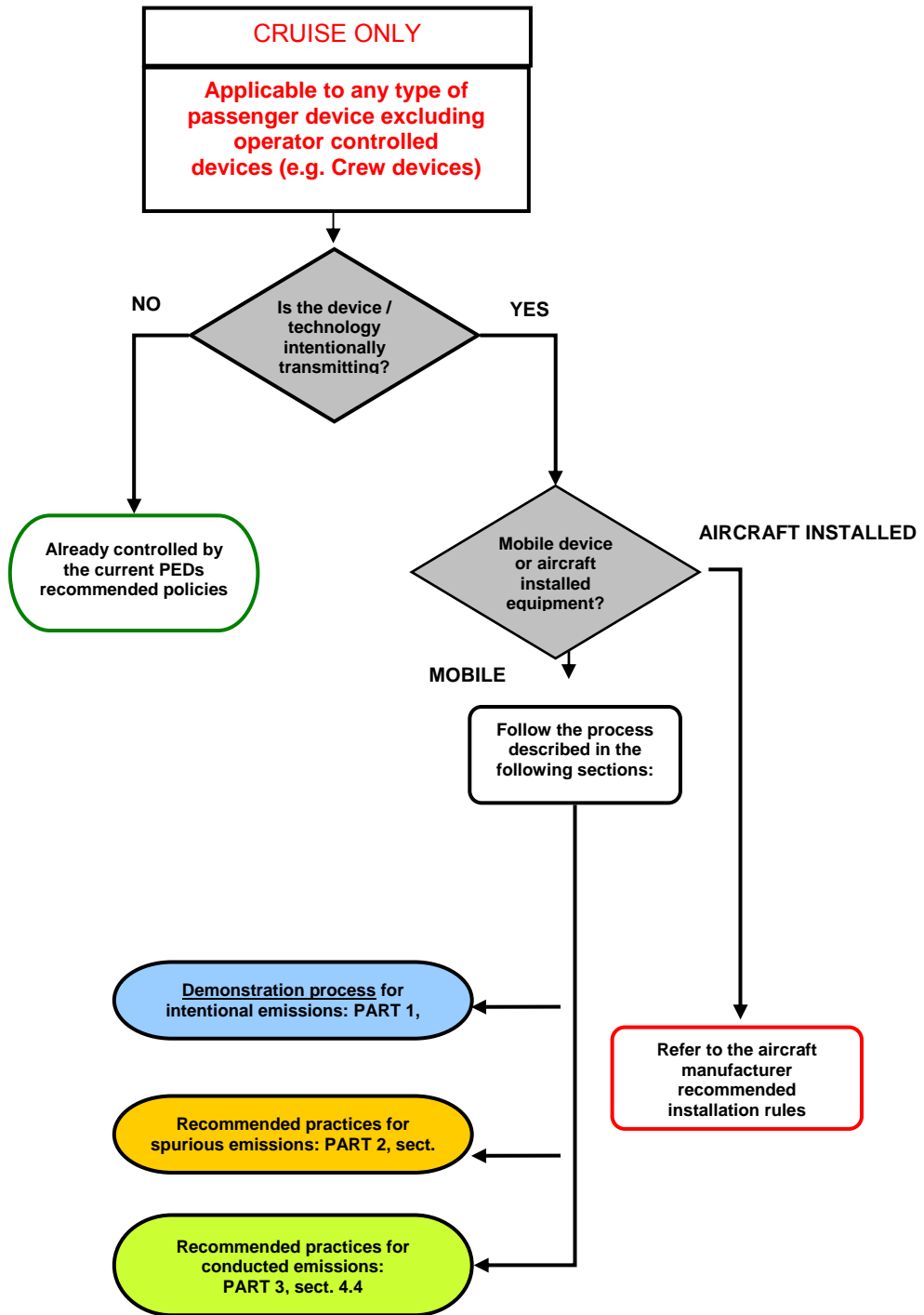

FIGURE 10 : DEMONSTRATION PROCESS TO APPLY ACCORDING TO THE TYPE OF PORTABLE DEVICE

## 4.2 PART 1: INTENTIONAL RADIATED EMISSIONS

The following section specifies how wireless services inside the aircraft, such as mobile telephone service, wireless data transmission, etc., are to be investigated to demonstrate electromagnetic compliance with the aircraft's systems. It describes how to verify that the intentional fields generated by the operation of the technology or Device Under Investigation (DUI) inside its operational frequency range would not interfere with aircraft systems when it is used on board. The testing may be necessary, as onboard wireless services differ from any usual aircraft qualification procedure due to two major points. Any wireless service is linked to an electromagnetic field emission, which is generally higher than the norm for unintended emissions. Generally, these services are separated from the aircraft electromagnetic spectrum and therefore a direct influence on the aircraft navigation and communication systems is not expected. Nevertheless, a compliance demonstration of the sensitive transmitter and receiver systems is necessary.

Wireless services usually exceed the emission limits for aircraft electronic equipment for functional purposes. A susceptibility investigation covering possible cumulative effects is then considered necessary as the electromagnetic field levels in the vicinity of the signal sources may increase to levels, which some aircraft equipment is qualified against.

The main objective of the introduced method is to identify possible interactions due to possible intentional emissions of wireless services from aircraft systems and passenger carried electronic devices (PED), and to ensure electromagnetic compatibility between wireless services and aircraft environment.

### 4.2.1 General Considerations

#### 4.2.1.1 Aircraft systems requiring evaluation by test

There are two basic methods to determine if a wireless technology is electromagnetically compatible with a particular aircraft configuration: test and analysis. Generally, analysis is preferred over test from the configuration management point of view. It must be based on a solid foundation, which can be the result of a previous aircraft test in which similarity can be established or a previous laboratory test in which the wireless technology RF threat was adequately covered during a ED-14/DO160 type test for HIRF. In cases where an analysis cannot be done, aircraft level testing would generally be required. A few different scenarios are evaluated:

- Aircraft that has not been qualified to a new wireless technology.
- In-Service Aircraft that has been qualified to a wireless technology, and installs a new aircraft system.

One of the very first steps is to fully characterize the RF threat of the wireless technology in terms of its emission characteristics at full operational capacity. These characteristics can be compared to the laboratory qualification test parameters of the aircraft equipment. If the laboratory test was more stringent, the EMC determination should be possible to establish by analysis. If not, either further justification in the analysis is required, or an aircraft level test would be necessary.

In some cases when a new wireless technology emerges, an aircraft immunity assessment is recommended. Once analysis or tests have led to operational approval, the probability for future qualification by analysis increases. After a sufficient number of aircraft tests and analysis, a specific wireless technology may be found to be electromagnetically compatible with commercial aircraft equipment in general or to a particular configuration.

When similarity can be demonstrated (same family of aircraft) it is sufficient to consider only the differences between an already qualified aircraft and that aircraft under consideration. Similarity analysis includes for example the differences in airframe apertures, aircraft wiring protection against RF exposure, location of aircraft equipment, and the criticality of the aircraft equipment.

#### 4.2.1.2 Aircraft systems not requiring evaluation by test

In some cases, particular aircraft system's equipment may not need to be tested for backdoor effects as a result of either:

- Successful laboratory equipment qualification to at least the waveforms and levels according to ANNEX 2 which are representative of the most widely used standards in mobile communications (GSM, CDMA2000...).
- Equipment qualified to ED-14D/E (DO-160D/E) Section 20, Categories U,R,V,W,Y and P may be assumed to safely cover exposure to a 100 mW power level (EIRP) from a T-PED at a distance of 10 centimeters. Categories T and S pass also but at distances of 35 cm and 1.8 meters, respectively. However, Cat S is rarely used for transport aircraft equipment. If the T-PED under investigation has an EIRP lower than 100 mW, and previous demonstrations and tests showed immunity for the investigated aircraft equipment, then there's a solid base for accepting that the T-PED technology onboard the aircraft will result in no backdoor coupling effects.
- If T-PED's sole means of transmission is identified as a low power Bluetooth transmitter, it may be considered no more a risk than a non-intentionally transmitting PED and use may be permitted during non-critical phases of flight (See also EUROCAE ED-118)
- Other cases, where systems may not need to be tested, are those, which were tested and successfully passed to frequencies and levels considered to be equivalent or more stringent than the T-PED threat of interest.

#### 4.2.2 Guidelines for backdoor coupling immunity qualification

The procedure described in this section (Figure 11) may be regarded as the step labelled as *Perform EMC Analysis and/or Test* in the process defined in chapter 2 of [1] for allowing the onboard T-PED operation. This process evaluates the EMC between the relevant T-PED technology's RF radiated emissions and the required performance of the aircraft systems for the previously identified T-PED usage scenarios.

The necessary input information for this process results from the *T-PED characterization sub process* and the *characterization of aircraft configuration sub-process*, which are described in chapters 3 and 5 of [1] respectively. The conclusions and results from these processes are presented in this document in ANNEX 2 for T-PED characterization, and in sections 2.1.4, 2.1.5, 2.1.6 and ANNEX 5 for aircraft configuration characterization.

With this information, the first step of the qualification process is to identify the relevant systems to be qualified against radiations from a given T-PED technology. The aeroplane operation requirements (JAR OPS 1.110) identifies that with respect to PEDs in general; "an operator shall not permit any person to use, and take all reasonable measures to ensure that no person does use, on board an aeroplane, a portable electronic device that can adversely affect the performance of the aeroplane's systems and equipment."

Therefore, when considering the operation of PEDs and T-PEDs specifically, all systems and equipment required for type certification, by the operating rules, or whose improper functioning would reduce safety must be evaluated.

The results of the evaluation will enable the identification of any interference issues that require mitigation, and the integrity of the mitigation will be directly related to the severity of identified interference effect.

For example

- The identification of an interference effect that is identified through a safety analysis of having a hazardous effect will require mitigating to a level commensurate to the hazardous condition, i.e. with an equivalent level of assurance to satisfy the 25.1309 safety objectives of this hazard.
- The identification of an interference effect that is identified through a safety analysis of having a minor effect will require mitigating to a lesser level that is commensurate to the minor condition, i.e. with an equivalent level of assurance to satisfy the 25.1309 safety objectives of this hazard.

In such cases, all phases of flight will need to be considered.

For the selected systems and equipment the identification of the corresponding RF immunity levels follows, which is a process described and concluded on in ANNEX 4 in more detail.

Before continuing, it's important to define the term *safety margin* as the comparison between the qualification level of the corresponding aircraft device (see ANNEX 4) and the worst-case emission levels of the T-PED technology in question. The emitted field strength of the T-PED is determined based on the expected locations of the T-PED and the victim receiver and hence the distance between the two. **The safety margin then is the ratio of qualification level to emission level, and it takes into account possible superposition effects resulting from reflections within the cabin for the worst-case scenario close to the EUT.** With this in mind, to determine if the aircraft is T-PED qualified follows.

Following evaluation of the safety margin (i.e. Analysis of T-PED characteristics vs. Aircraft systems immunity), two results are possible:

- Sufficient Safety Margin (i.e. higher than 6 dB):

Regarded as sufficient and this particular T-PED technology is not expected to cause interferences and therefore the use of this type of T-PED in this aircraft configuration may be allowed. A lower limit of 6 dB was chosen as the safety margin to account for reflections from metallic structures, which could double the field strength. If the safety margin is greater than 6dB then the investigated T-PED technology may be allowed onboard the A/C, provided that no front door or back door effects are observed or analyzed.

- Insufficient safety margin (i.e. less than 6 dB):

A safety margin of less than 6 dB is in general considered to be insufficient. The first step is to identify and analyse the possible options that may increase or demonstrate the immunity of the aircraft equipment. If acceptable options exist that increase the safety margin and ensure EMC, they should be implemented. Potential options are:

- Requalify the affected aircraft equipment to a higher qualification threshold. This might include modifying the equipment.
- Limit or control the T-PED's transmission power level.
- Improving the aircraft systems installation inside the aircraft.

Requalification would be conducted with the help of the test procedures defined in ANNEX 3. Maximum transmitted power and electric field levels for different standards are proposed in ANNEX 2. Note that it is needed to base the A/C testing mainly on power testing and not on the E-field, because of the uncertainty about the electric field level that would be transmitted by the T-PEDs. If a safety margin of 6 dB or more can be demonstrated the T-PED technology may be used on board that particular aircraft.

If the safety margin is below 6 dB after the options have been implemented an aircraft test is necessary in any case (ANNEX 5 and ANNEX 6). In the case that no interference is observed during the test then this kind of T-PED technology may be used on board that particular aircraft.

If adverse effects are observed, the outcome of this process may be that the use of such T-PED technology is either allowed or prohibited on board an aircraft. If measures to mitigate the interference risk are available, they should be implemented and the safety margin should be re-evaluated. A successful improvement should be verified by a further aircraft test. If the safety margin has not improved, the process may be either repeated for introduction of further mitigations or the T-PED technology may not be used.

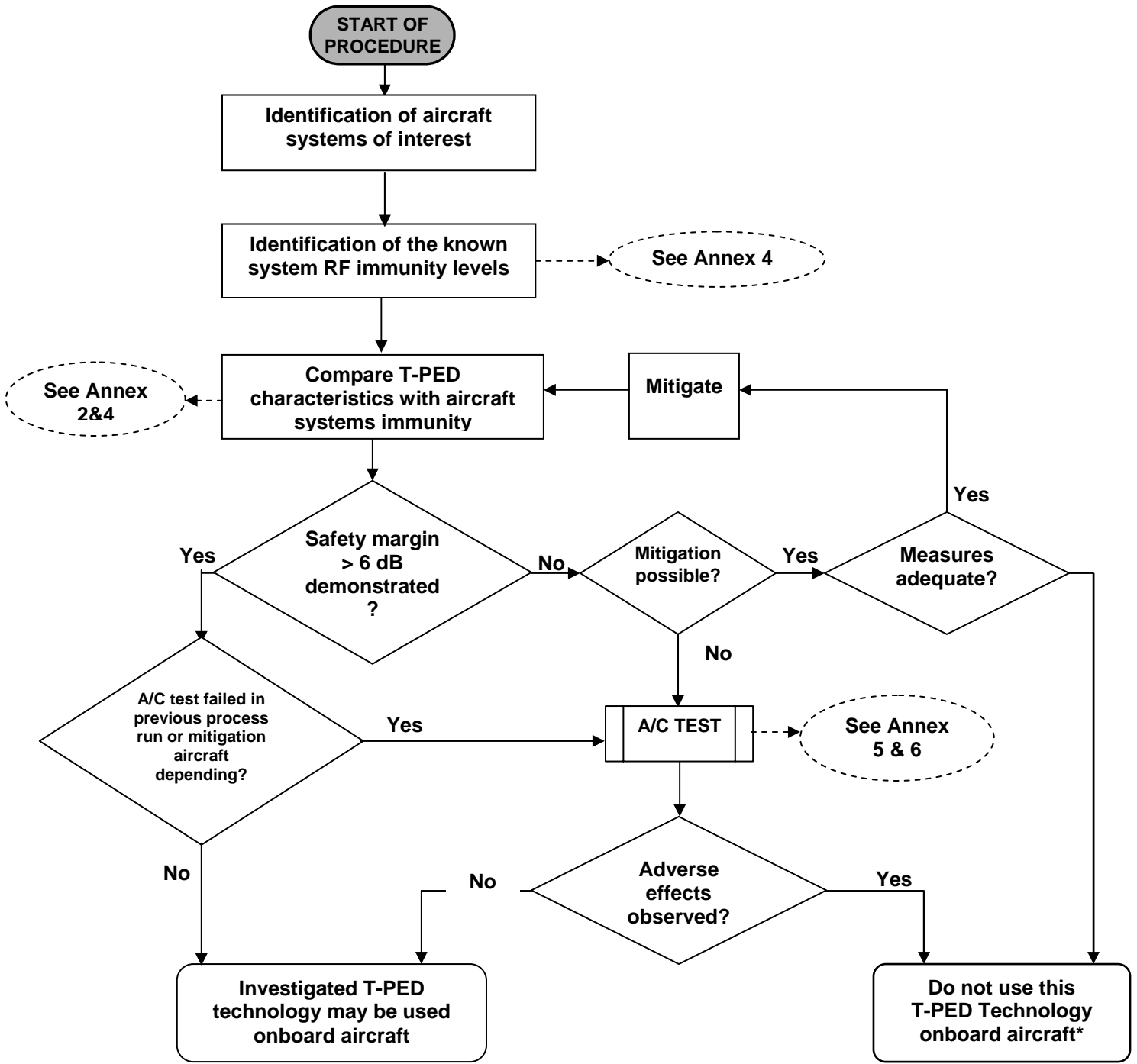

FIGURE 11 : PROCESS FOR BACKDOOR COUPLING IMMUNITY QUALIFICATION

## 4.3 PART 2: SPURIOUS RADIATED EMISSIONS

### 4.3.1 Devices intended for use during cruise phase of the flight only

If the device is not an intentional transmitter, the operation of the device is already controlled under the current applied PED policy. Hence, as depicted in Figure 10, this part applies to the mobile intentional transmitters that could be used during the cruise phase of the flight.

The standard limits for spurious emissions to which the intentional transmitters are submitted are less stringent than the limits for non-intentional transmitters.

- The measurement campaigns as well as technology analysis shows that the spurious emissions from the T-PEDs are typically even lower than for any laptop computer, and not higher than for any small electronic devices. These measurements and analyses have been done for WLAN devices, mobile phones and low power wireless devices.
  - The technology evolution of handheld electronics is going towards smaller and lighter devices, using less power and with less power dissipation,
  - The intermodulation products generation, specific to the T-PEDs operations, has been demonstrated to be a minor issue (see [1], app. 6.E)
  - The associated risk of interference is not higher in any case that for any non-intentional transmitter.
- ➔ **Therefore, in the case of devices intended for use in the cruise phase of flight only, no specific EMC additional analysis or test procedure has to be applied concerning spurious emissions.**

However, the T-PEDs are normally submitted to general operational constraints and therefore, should be:

- Off and kept properly stowed during critical flight phases,
- Properly kept stowed in non-critical flight phases when a risk of turbulence is identified.

By “switched off”, it has to be understood that there is no internal activity in the device. Depending, on the PED, some specific modes may exist, ranging from the full “OFF” state, i.e. all power sources shut off, to the full activity state.

A potential risk of interference to communication and navigation systems exists during cruise phase. If interference is suspected, the suspected PED or T-PED should be powered off. If these devices are demonstrated to be the interference source, their use should be revised.

The occurrence of such an event shall then be reported to the aircraft manufacturers and the competent authority, as stated in the section 3.6.5.

## 4.4 PART 3: CONDUCTED EMISSIONS

The aim of this part is to give guidance concerning coupling from PEDs connected to the aircraft power network or wired communication network. This part is concerning any PED, which can physically be in contact with aircraft's wired data or power networks.

If the aircraft provides a PED connection possibility, the operator or airframer shall ensure that the connection outlets have been correctly designed for this purpose. Only power outlets designed for the connection of PEDs should be used. Such outlets are typically installed at the passenger seats.



It is sufficient to confirm that these outlets provide for example adequate filtering (protection circuitry). Passenger accessible wired network connections shall be separate from avionic networks by hardware means.

The use of service outlets in galleys, cockpit and on the cabin sidewall panels is not recommended for PEDs, if it is not confirmed that the required protection circuitry is not installed. Use of lavatory power outlets shall be limited to use with shavers only. The use of other devices is not recommended.

Technically, unwanted conducted emissions of PED are not relevant beyond a frequency of 400 MHz. Consequently, for aircraft outlets filtering shall be considered up to this frequency. The recommended filtering characteristic should provide at least 20 dB additional protection against unwanted conducted emissions of the PED.

## ANNEX 1

### GUIDANCE TO AIRCRAFT OPERATORS FOR DEVELOPMENT OF STANDARDISED PED POLICIES AND PROCEDURES

#### A.1.1 DEVELOPMENT OF COMMON PED POLICIES AND PROCEDURES

Aircraft operators that allow the use of PEDs onboard aircraft are required by their National Aviation Authorities to develop policies and procedures, which govern PED use. This appendix provides guidance to Operators intended to assist in the development of policy and procedure changes required to accept PED usage on aircraft, subsequent to the performance of analyses and tests that are described within this document and/or DO-294A. Such policies and procedures, as developed by Operators and accepted by regulatory authorities, must be clear and unambiguous to aircraft crew (flight and cabin crew) and passengers. Aircraft Operators should consider the following recommended practices when developing and evaluating their PED policy.

Not all aspects of the guidance may be applicable to all Aircraft Operators; however, implementation of the complete scope could be beneficial to both the Operator and passenger communities by providing a more universal understanding of restrictions on aircraft PED usage.

#### A.1.2 FACTORS INFLUENCING DEVELOPMENT OF T-PED POLICIES AND PROCEDURES

##### A.1.2.1 Regulatory requirements

Operational Requirements specify that no person may operate, and no Aircraft Operator or pilot in command of an aircraft may permit the operation of any portable electronic device on an aircraft unless it has been determined (by the operator or pilot in command) that such portable electronic device will not interfere with the performance of the aircraft systems and equipment. Furthermore, an Aircraft Operator must establish procedures that specify ground staff and crewmember responsibilities. Regulatory Authorities also publish guidance material that recommends practices to be considered within the procedures that control the usage of portable electronic devices.

For example, for European Operators, the requirement to have a policy can be found in JAR OPS 1.210 (a) and 1.285 (2)(b)(vi). The requirement to prohibit the use of any portable electronic device that could affect the aircraft systems' performance is found in JAR OPS 1.110, FAR 91.21, 121.306, 125.204 and 135.144 provide similar regulations for U.S. Operators. A European Operator would typically include the PED Policy in the OM-A (Operations Manual part A).

The requirements regarding type of equipment and operational phase of usage can be found in individual national regulations. The JAA guidance material can be found in the JAA Temporary Guidance Leaflet No. 29. The U.S. requirements are defined in FAA Advisory Circular 91-21-1A.

##### A.1.2.2 Differing aircraft types within Aircraft Operators fleet

In general, Aircraft Operators have a variety of aircraft types within their fleets. It is likely that, at any point in time, the level of T-PED use that is permissible will vary across the fleet, depending upon:

- the extent to which testing and analysis has been performed on various aircraft types (under the testing protocols of DO-294A or ED-130),
- the results of such tests/analyses,

- systems installed on the aircraft to communicate with and control onboard T-PEDs

Aircraft Operators policy and procedures in effect for each different type of aircraft must reflect these factors in order to assure compliance with the regulatory requirement that any PED will not cause interference with the aircraft systems. For example, aircraft types within a fleet might include aircraft which:

- have not been analysed/tested under ED-130 or DO-294A
- have been analysed/tested for operation of 802.11 devices, and which are equipped with 802.11 access points that are capable of providing service while airborne
- have been analysed/tested for operation with cellular technologies, and which are equipped with pico cells and control systems that are capable of providing service while airborne

### A.1.2.3 International Harmonisation

Given the strong worldwide growth of commercial aviation, air travellers increasingly find themselves using multiple carriers and crossing multiple regulatory boundaries. Often passengers fly in similar aircraft used by many different airlines. The existence of common policies and procedures governing the use of PEDs on board aircraft may be expected to improve passenger understanding and acceptance of practices related to such devices. Therefore, it is strongly recommended that T-PED policies be harmonized across all regulatory authorities and Aircraft Operators. Such harmonization will minimize passenger confusion and improve the rate at which passengers become familiar with new T-PED-related procedures.

**An important step to achieve international harmonization of PED policies between operators is to ensure harmonization of national and international operational regulations. However, it should be recognized that aircraft operators will collectively have a range of PED tolerances, depending upon the extent of analysis and testing completed and/or the degree to which on-board systems support communications with T-PEDs.**

### A.1.2.4 Human factors related requirements for an effective policy

In order to be appropriately effective, an aircraft Operator's PED policy and procedures will need to be unambiguous and readily determined. To ensure that PED usage policies and procedures are briefed, understood and accepted by those directly affected (e.g. flight deck crew, cabin crew and passengers) and indirectly affected (various ground customer service personnel with passenger contact) a thorough human factors review of the PED policy during the development phase is essential.

In addition, subsequent, regular reviews will be necessary to evaluate relevant incident reports and any user feedback. These could be used to feed into the periodic policy and procedure changes. The following subsections recommend guidelines for human factors reviews of PED policies.

#### **Passenger expectations**

Air travel today is increasingly becoming a normal part of life for a significant percentage of the world's population. This leads some passengers to expect that their use of portable electronic devices, upon which they have come to rely, should be acceptable anywhere, including onboard aircraft.

Compounding this problem is the contrast between the dynamic, rapidly changing consumer electronics technology marketplace, and the slower development and certification cycles inherent with the safety-aware air transport environment. These factors suggest that restrictions on the use of certain devices must be clearly explained in order to maintain aircraft safety by ensuring passenger compliance.

### **Localized issues**

The presentation of the Operator's policy to airline staff and the public and the methods of enforcement need to be effective where there are local variations in understanding and differing cultural and social issues. Therefore, the aircraft operator's interpretation and implementation of the Template PED Policy outlined in this appendix may need to be modified to account for local variations in the following:

- Cultural circumstances
- Social interactions
- Local languages and English aptitudes
- Local terminology

In addition, effects on aviation security by PED usage policies must also be addressed at the local level. This document does not provide any guidance related to security issues, as these are not based solely on technical and human factors considerations and are therefore classified as out of scope for DO-294A and this document. Security issues are (by the nature of such threats) dynamic and rapidly evolving; thus, any guidance herein would quickly become outdated.

#### **A.1.2.5 Identification of PEDs**

The Aircraft Operator's policy must identify PEDs in a manner that is well understood, so that an inexperienced traveller can easily and correctly identify whether restrictions apply to their device(s).

PED policies must define PED device classes that are broad and well understood, such that an inexperienced traveller can easily and correctly identify the operator-prescribed restrictions applicable to their device(s). Policy differences based on technical details that are not apparent to the casual observer, such as modulation schemes or data protocols, while relevant to the airline engineering staff, may create confusion and are irrelevant to the flight and cabin crews and the general public.

#### **A.1.3 GENERAL GUIDANCE FOR DEVELOPMENT OF AN OPERATOR-SPECIFIC PED POLICY**

This section provides basic guidelines for development and regular review and update of the PED-related elements of an Operator-specific PED policy.

##### **A.1.3.1 Basic guidelines**

This appendix provides a PED policy template that can serve as a starting point for the development of an individual operator's PED policy. An operator using this PED policy template needs to assess local requirements, airline fleet composition and installed aircraft equipment as well as existing operational procedures, in order to determine the appropriate application of the template. The revised PED policy then needs to be included in operation manuals and crew manuals (e.g. AFM, OM-A). The revisions may require approval or acceptance by the appropriate national aviation authority.

##### **A.1.3.2 Crew PED Usage**

Devices that are provided to assist the flight deck crew and cabin crew in their duties need to be used in compliance with the procedures and conditions stated in the Operations Manual of the aircraft operator.

Such equipment should be switched off and stowed during all phases of flight, unless the aircraft operator has performed tests that confirm that any use of these devices is not a source of unacceptable interference or distraction, and that the devices do not pose a loose-item risk or other hazard and the conditions for their use in flight are stated in the operations manual.

Aircraft operators should alert their flight crews of the specific risks from, active mobile phones on the flight deck and introduce procedures to ensure that they are switched off. Flight deck crew and cabin crew should also avoid having mobile phones switched on or make use of other transmitting devices during critical pre-flight procedures (e.g. when loading route information into navigation systems or when monitoring fuel loading).

In all other cases, flight deck crew, cabin crew and other persons involved in dispatching the aircraft will need to observe the same restrictions as passengers.

#### **A.1.3.3 Initial T-PED policy development, reviews and updates**

Aircraft operators are presumed to have PED policies in place that are consistent with regulatory requirements, and under which on-board PED use is prohibited other than in limited situations (e.g. prior to the aircraft door being closed at departure and after the aircraft has landed on arrival.)

Initial T-PED policy/procedure modifications will be required after completion of analysis and testing per DO-294A or this document, for certain types of T-PEDs (e.g. laptops equipped with WLAN and/or cell phones.) Some subset of the aircraft types in a fleet, or all aircraft in the fleet, may have coincident implementation of policy changes.

If the Aircraft Operator wishes to extend the variety of PED types whose use is permitted, further testing and analysis will be required to assure that they can be used while complying with regulatory/safety requirements. Until the completion of these tests and development of revised policies and procedures, the use of T-PED types not included on the “unrestricted list” should continue to be prohibited.

The ability of the aircraft operator to effectively manage this, such that not-permitted PEDs are prevented from being used requires that the crew be able to readily identify PED types in use and determine whether they are permitted. Periodic reviews and updates of identification methodologies may be required to assure that crews are provided with current information.

Passengers’ expectations are likely to vary with experience, between different operators and aircraft types. In addition passengers’ overall familiarity with PED-related policies and procedures will increase over time, and may lead to periodic policy modifications or simplifications.

#### **A.1.3.4 Communications complexity**

Clear policy and procedure statements need to be included in passenger briefings. To maximize the overall effectiveness of such briefings, policy variations with respect to different PED types, aircraft types and phases of operation should be minimized. The permitted phases of operation and identification of the device types that may be used in each phase should be clearly stated to all involved parties. PED-related briefings should be comprehensible by passengers and crew and should be as consistent as possible between aircraft types within an Operator’s fleet.

#### **A.1.3.5 Passenger-Targeted Communications**

##### **Routine announcements**

Pre-flight and in-flight announcements to passengers should include information regarding when PEDs can be used on the flight, in a manner that is consistent with information regarding PED use in general.

Passengers’ attention should also be drawn to any in-cabin signage, which indicates whether or not PEDs may be active, and to any resources available that aid in the identification of which PEDs may be used on the aircraft.

### **Cabin Signage**

To provide consistent passenger recognition across domestic and international operators, signage indicating whether PEDs can be used on any given aircraft should be readily visible upon entering the aircraft.

On aircraft where PEDs are allowed, operators should use in-cabin signage as a means to communicate when specific types of devices may be used.

For example, the existing “no smoking” light could be adapted, with new control logic and either a written or symbolic message. (One airframe manufacturer already offers such a “no electronic devices” light instead of the former “no smoking” light). In any case, PED usage signage should be mounted in locations visible to all passengers while seated throughout the cabin and lavatories.

Utilization of a universal signage icon such as the “All Transmitters Disabled” symbol proposed by the Consumer Electronics Association (CEA)<sup>1</sup> is strongly recommended, although passengers will also require ongoing education regarding its meaning until its use becomes widespread and its meaning is widely understood.

Any illuminated indicator for PEDs should adopt logic for “use permitted” such that illumination indicates permitted use, thus providing for aircraft where no indication is provided.

### **PED policy information resources for passengers**

Airlines usually provide in-flight magazines, located in the seatback pockets, as a courtesy to passengers. These magazines are a convenient and easily recognized resource for passengers to obtain detailed information regarding the Operator’s PED policy. Another resource located in the seatback pockets is the safety briefing card, which could reflect applicable information, for example, from the CEA Recommended Practice guidelines. However, these cards are required to ensure passengers are aware of actions in an emergency situation. It should be avoided that too much information in this cards dilutes the messages for emergency situations. Using a separate card should therefore also be considered.

To avoid misunderstandings with flight deck crew and cabin crew requests, passengers could be provided with clear information relating to the aircraft operator’s PED policy in advance of their date of travel. This could enable passengers to adjust their travel plans to match their intended PED usage requirements and minimize in-flight frustrations. Methods that could be used to provide information regarding the PED Policy prior to travel could include:

- Ticket cover / e-ticket passenger information
- Regular customer mailings – Frequent flyers
- Advisories on the aircraft operator’s Internet site

Note that it is essential that all information contained within these publications be consistent with the aircraft operator’s PED policy, as well as the instructions briefed to the passengers onboard the aircraft.

---

<sup>1</sup> Recommended Practice – Status Indicator for and Control of Transmitters in Portable Electronic Devices (PEDs), v. 1.0, Consumer Electronics Association, Arlington VA, October 2004, [http://www.ce.org/publications/books\\_references/Recommended\\_Practice\\_for\\_PEDs-V\\_1.0\\_October\\_2004.pdf](http://www.ce.org/publications/books_references/Recommended_Practice_for_PEDs-V_1.0_October_2004.pdf)

### A.1.3.6 Flight Deck Crew and Cabin Crew Training

To implement effective PED usage procedures or restrictions, flight deck crew and cabin crew must receive sufficient training regarding the aircraft operator's policies. This includes understanding general differences in the technologies, the implications of usage during different phases of flight or on board different aircraft types, etc. A basic understanding of each policy's implications will allow aircraft crew to enforce the procedures in the most appropriate and tactful manner. Policies that vary substantially between fleet types, operational phases, aircraft operators, etc., should be kept to a minimum. Where different policies exist, aircraft crews should understand the reasons for the variations so that they can clearly and easily explain the differences to the passengers.

For example, on a large transport category aircraft, the separation of passengers from sensitive aircraft equipment is usually sufficient to avoid interference, but in smaller aircraft or on flight decks or where PEDs are used that produce exceptional electric field radiation, some aircraft equipment may be affected.

Flight deck crew should be made aware of the potential for interference effects and ensure that when necessary, appropriate coordination and communication with the cabin crew is used to ensure that PEDs that may be suspected to be a cause of such interference are turned off.

Similarly, the general aviation community should be alert to the interference risk from PEDs in smaller aircraft.

#### **Aircraft Crew Member Training on PED Policy**

A thorough working knowledge of the company policy regarding allowed use of PEDs is an essential prerequisite for obtaining the cooperation of passengers. Both flight deck and cabin crews must be provided sufficient training to achieve sufficient levels of understanding to ensure passenger cooperation.

Flight deck crew and cabin crew training should include the aircraft operator's policy regarding the use of PEDs.

- The actual PED policy and how to implement it (Examples may be provided);
- Awareness of potential impact to aircraft systems from improper operation of PEDs and coordination and communication between flight deck crew and cabin crew;
- Typical logos identifying certain standards (e.g., FCC part 15) or operating modes (e.g. Transmitter disabled, if it becomes an industry standard.);
- Service provider logos, which are on many types of T-PEDs and which in turn are reliable indicators of the type of T-PED
- Typical operating procedures of devices.

Recurrent training is typically provided on an annual basis to each crewmember, and should include:

- The Aircraft operator's PED policy including any recent changes;
- Any recent examples of known interference with aircraft systems; and
- Recent changes of technologies that may be seen in the field.

### **Information Resources on the PED Policy for Crew Members**

All flight deck crew and cabin crew should receive, during conversion training and recurrent training, specific information explaining how and where to obtain the Aircraft operator's written PED policy and background regulatory documents. The basic policy document for a Commercial European Operator is the OM-A (Operations Manual part A). Part A contains the company general regulations not specific to an individual type of aircraft. The aircraft specific part of the European regulations (OM-B) may include additional remarks if the allowance (or non-allowance) of certain PED technologies applies only to specific aircraft types. The basic policy documents for a U.S. Commercial Operator are FAR 91.21 and AC 91.21-1A.

In addition, it is recommended that the Aircraft Operator supply each aircraft with an individual briefing card in an easily understood format. The aircraft crew could use such a briefing card to clarify details of the PED policy with passengers for that particular aircraft type.

### **Methods to de-escalate conflicts**

Use of PEDs, especially mobile phones, has the potential to increase the number of disruptive passenger incidents. This should be reflected in aircraft crew conflict management training.

#### **A.1.3.7 Coordination with Airline Ground Staff and Handling Agents**

PED regulations should be broadly identified to the public using all appropriate forms of the Operator's public relations media. It is essential that passengers get consistent information on the allowed or restricted use of PEDs. On any given passenger's interaction with the Operator, this consistency must include not only crewmembers on the aircraft, but also the reservations agent as well as the check-in agent at the gate. All should be provided some minimal, consistent knowledge and interpretation of the Operator's PED policy, access to appropriate printed information that can be supplied to the customer, the ability to refer the customer to a knowledgeable employee within the organization or to a public information source such as a web page. Note that special attention should be given to the situation where non-company staff handles a part of the customer contact.

#### **A.1.3.8 PED Policy Template**

The use of portable electronic devices (PEDs) on board aircraft by flight deck crew, cabin crew and passengers may present a source of electromagnetic radiation with an attendant risk of adverse interference effects to aircraft systems. Aircraft operational requirements require operators to take appropriate steps to prevent any such adverse interference.

This information contained within this PED Policy Template is recommended as the basis for the formation of PED policy to be implemented by the aircraft operator. However, the aircraft operator's National Aviation Authority may direct additional requirements or restrictions that the aircraft operator must recognize and implement in addition to the master policy material.

#### **A.1.3.9 General PED Restriction**

The general policy is that all PED use is prohibited and all PEDs should be switched OFF and fully stowed for the entire duration of the flight, unless the aircraft operator has determined that certain PEDs could be used during specific phases of flight. This determination should be based on national aviation authority guidance and policy, and/or operator evaluation and testing.

This restriction applies to personal PEDs carried onboard by passengers and flight crew and to those PEDs provided to the passenger by the aircraft operator.

The restriction should not apply to portable, non-transmitting PEDs intended to assist flight deck and cabin crews in their duties, which the operator has shown to cause no interference during the PED's certification through a controlled assessment of its use.



### A.1.3.10 Unrestricted Use

The devices identified below have been shown to generate negligible emissions. Therefore, the operator might decide that no restrictions of these devices need apply.

- Hearing aids;
- Heart pacemakers;
- Other approved medical devices (e.g., insulin pumps, ventilators, cochlear implants);
- Electronic watches;
- Electronic nerve stimulators;
- Pocket calculators and other devices powered by micro-cell batteries, solar cells and other low power consumption equipment.

**NOTE:** *If any of the above PEDs have the ability to intentionally transmit data, or are provided with a RF remote control, such a function must be disabled before the PED's use is permitted, unless the aircraft operator has also determined that this generates negligible emissions.*

### A.1.3.11 Restricted Use

Announcements should be clearly broadcast to provide passengers with sufficient opportunities to verify that all of their PEDs are switched OFF once all of the aircraft doors are closed before the start of the flight.

The cabin crew should monitor passenger use of PEDs during flight and, where necessary, action should be taken to ensure that any PED that is suspected of being a potential or real cause of interference, or is suspected of not being a "permitted" PED, is switched OFF.

#### Non-critical phases of flight

Whilst all PEDs should be switched OFF, fully disconnected from any in-seat electric power supply and stowed prior to the commencement of the flight, it is accepted that the aircraft operator can determine whether the use of certain PEDs could be permitted during certain non-critical phases of flight, by reference to National Aviation Authority guidance and policy, and/or their own tests.

**NOTE:** *The definition of the term "critical phases of flight" is likely to vary between the National Aviation Authorities, and it will be the aircraft operator's responsibility to determine the specific definition that should apply to their operation.*

For example, the critical phases of flight may include the taxi, but will almost certainly include take-off, approach and landing. Abnormal or emergency conditions that may include turbulence encountered during the cruise phase of flight may also be considered critical and stowing of PEDs at this time may be necessary to avoid loose article hazards.

For the example above, the non-critical phase of flight would be considered to be the normal, non-turbulent cruise.

The following is a non-exhaustive list of example PEDs that the aircraft operator might determine could be safely used and thus consider acceptable to permit such use during non-critical phases of flight:

- Personal computers (Laptops) and associated peripheral devices (except embedded or plug-in network devices that provide active transmitting communication interfaces unless the network device is positively deactivated);
- Personal Digital Assistants (PDAs) without embedded or plug-in network devices that provide active transmitting communication interfaces unless the network device is positively deactivated;

- Note: in both of the above cases, the operator may determine that the restriction associated with the active transmitting interface does not need to apply to low power transmitting devices that are fully compliant to the Bluetooth standard for wireless personal area networks, and this is readily identifiable.
- Personal handheld electronic games;
- Audio or video recording and/or playback systems (e.g. CD, DVD, MP3 players);
- Cameras (digital, video or still), except those included within mobile phones;
- Shavers

#### **Aircraft Parked at the gate or stall with a main aircraft cabin door open**

While the aircraft is parked the restrictions relating to any use of PEDs in flight will not normally apply.

However, during aircraft boarding, certain restrictions may apply depending on the individual airport authority rules. For example, most airports do not allow any persons to use a mobile phone when outside, but in the vicinity of, the aircraft.

#### **Aircraft on ground prolonged departure or arrival delay**

At the sole discretion of the aircraft PIC, the use of intentionally transmitting PEDs, such as mobile phones, might be permitted when the aircraft is stationary during prolonged departure delays, provided that sufficient time is available to check the cabin before the flight proceeds. Similarly, after landing, the PIC may authorize the use of PEDs in the event of a prolonged delay for parking/gate position (even though the doors are closed and the engines may still be running).

#### **Taxi-in**

After landing, once clear of all active runways, the aircraft PIC might authorize the use of intentionally transmitting PEDs, such as mobile phones if such use has been proven by the aircraft operator not to be source of interference or distraction.

However, this will not be permitted when the aircraft operator's national aviation authority considers that the taxi-in is a critical phase of operations.

### **A.1.3.12**

#### **Controlled Use**

The aircraft operator might request that the aircraft be modified to permit the controllable use of certain intentionally transmitting PEDs.

Such an example would be the installation of a Wireless Local Area Network (WLAN), which would permit the controlled use of WLAN-equipped PEDs operating with the aircraft's network.

Installation of such a WLAN network system will be subjected to modification action and approval of an appropriate Type Certificate or Supplemental Type Certificate modification. The modification should include an assessment of the likely WLAN PEDs that will interface with the network or that might operate within ad-hoc networks. The aircraft operator will need to determine that the installed WLAN network or WLAN-equipped PED within that network or within any ad-hoc network is not a source of unacceptable interference or other safety hazard including system failure before such PED use is permitted.

The operation of the installed WLAN may be permitted during non-critical phase of flight. However, all installed equipment should be switched OFF and all WLAN PEDs switched OFF and stowed during critical phases of flight.

#### A.1.4 PROHIBITED USE

If the aircraft operator has not determined whether any other PEDs could be safely used, the aircraft crew will need to ensure that they are switched OFF and fully stowed for the entire duration of the flight.

The following is a non-exhaustive list of example PEDs that the aircraft operator might determine not to be safe and thus prohibit any use during flight:

- Personal computers (Laptops) and associated peripheral devices with embedded or plug-in network devices that actively transmit as communication interfaces;
- Mobile phones and similar PDA devices that actively transmit as communication interfaces;

**NOTE 1:** *This restriction may not apply in certain cases; see section titled Policy – restricted usage, 4 Taxi-in.*

**NOTE 2:** *Certain mobile phones and PDA devices are capable of being used with the transmitting element turned off. Any such operation of these devices when the transmitter has not been turned on should be controlled in the same manner as for any unintentionally transmitting device. See section titled Policy – restricted usage, 1 Non-critical phases of flight.*

However, if the means by which it can be shown that such a device is in its transmitting or non-transmitting mode is not clearly evident and easily distinguishable by the flight deck crew or cabin crew, it remains the aircraft operator crew's responsibility, in accordance with the operational requirements, to ensure that the use of such a device is not permitted.

Prior to permitting the use of such devices, an aircraft operator should give consideration to the following:

1. Ensure that use of any device with a non-transmitting "safe" mode that operates as an intentional transmitting PED when initially switched on, prior to being put into its "safe" mode is prohibited.
  2. Provision of clear instructions to flight deck crew and cabin crew to enable them to:
    - i. Easily distinguish between permitted and non-permitted devices.
    - ii. Determine that the devices are being operated in their "safe" modes.
    - iii. Determine that any displayed "safe" mode was actually preventing transmissions of the actual device and was not continuing to transmit. Phone signal detectors, either portable or installed in the aircraft, have the potential to assist the cabin crew in detection of device transmissions or operation of non-permitted devices, and enable appropriate follow-up action.
    - iv. Ensure the ability to continue to efficiently prevent the use of non-permitted devices
    - v. Ensure that all devices with non-transmitting "safe" or equivalent modes are completely switched OFF when the announcements to switch OFF all devices are made.
- Two-way transmitters, such as two-way pagers, walkie-talkies, amateur radios and citizen's band (CB) radios;
  - Devices designed to radiate radio frequency energy, except for those devices permitted in the controlled usage section;
  - AM/FM radio receivers;
  - Portable televisions; and
  - Remote radio-controlled toys.

**A.1.5 SPECIAL CASE USAGE**

To support aircraft operators who wish to allow the on-board use of specific PED s, which may include those listed below, aircraft manufacturers, or appropriately approved design organisations, should work with the aircraft operators and national aviation authorities to incorporate appropriate modifications to the aircraft. National aviation authorities will issue design approval certificates for the “installation” of such equipment that may be introduced by minor design changes or major design changes (supplemental type certificates for such modifications that originate from organisations other than the aircraft’s type certificate holder). The PED would be tested to ensure that the use of such PEDs did not cause adverse interference to aircraft systems and equipment.

- Electric or electronic medical support equipment
- Airborne video-conference installations
- Special cargo utility equipment

## ANNEX 2

### ASSESSMENT OF THE FIELD STRENGTH GENERATED BY INTENTIONAL TRANSMITTERS

The expected use of wireless communication inside the aircraft cabin creates a new internal electro-magnetic, RF environment. This annex evaluates the EMI potential of several wireless communication signals, including those intentionally emitted by transmitting personal electronic devices (T-PED). For this purpose, general features of radio communication signals are investigated in section A 2.3. The EMI potential is characterized with the help of EMI threat criteria. They reflect the time domain representation and further radio signal characteristics such as occupied frequency spectrum, modulation techniques, number of parallel transmitting portable mobile devices and transmission power levels. The threat criteria are introduced at the beginning in section A 2.2, before the evaluation of the different radio communication standards starts. The following communication standards are evaluated:

Application	Mobile Phone	Data Communication	Professional or Personal Mobile Radio
Access Schemes			
TDMA (time division multiple access) CSMA (carrier sense multiple access)	GSM, i-DEN, IS-136 DAMPS, PDC, PHS	IEEE 802.11a, b, g, ZigBee (IEEE 802.15.4)	TETRA
CDMA (code division multiple access) FDMA (frequency division multiple access)	UMTS, NAMPS, AMPS, CDMAone, CDMA2000	MOBITEX II, Bluetooth	TETRAPOL, EDACS, Project25/APCO25, PMR446, MPT-1327

**Table 8 : Evaluated wireless communication standards**

Subsequently, according to the groups of access schemes according to Table 8, the standards are characterized with the help of two simplified representative signal waveforms. It will be shown that one waveform is applicable for all TDMA-like mobile phone, data communication and professional mobile radio standards investigated within the document. The other continuous wave test waveform is applicable for purely CDMA/FDMA based access schemes. Those two waveforms are recommended for equipment qualification for any new aircraft equipment and for full-scale aircraft testing for the EMC (electromagnetic compatibility) demonstration on legacy aircraft. They represent suitable signals covering the internal electromagnetic transmitter environment due to the most likely present T-PEDs or wireless communication systems inside the aircraft.

The test levels associated with the waveforms depend on the transmitted power of the T-PED and the potential distance between the equipment under test and the T-PED. Field strength levels, which in general refer to a close distance of 0.1 m between T-PED and equipment under test and power levels needed are shown in section A 2.5, which apply for aircraft testing (retrofit qualification). The power levels in this section refer to a test procedure, where the testing antenna is located at a close distance from the EUT. This second "transmitted power test procedure" is at present not included in DO-160.

Section A.2.6 introduces an envelope for the entire frequency range between 300 MHz and 6 GHz, with no gaps, even for frequencies where no T-PED standards are in use, which applies for laboratory equipment qualification. For field strength based qualification two levels are proposed for CW-like standards. The first (higher level) is valid for equipment, which may be located in close proximity (up to 0.1m) to the T-PED. The lower field strength level is valid for equipment which is located at a distance greater than 1m to the T-PED. The same applies for the TDMA-like pulse modulated waveform. In addition for both test waveforms, the transmitted power applicable for testing is given.

An additional feature of the internal electromagnetic transmitter environment is that the worst-case illumination of equipment by T-PEDs is a very local phenomenon, i.e. its effects extend only to the close vicinity of the device, in contrast to the EMI impact of, for example, the EMI external environment that includes high intensive radiated fields (HIRF). In order to provide an uniform illumination, the existing RF susceptibility test procedure requires, according to ED-14/DO160, a distance between equipment under test (EUT) and testing antenna of 1m. 0 deals with alternative test procedures, in order to account for the local illumination during equipment qualification tests. The method proposed is intended to be applied in addition to the existing ED-14/DO160 test procedure and covers the local illumination of equipment by T-PEDs.

### **A.2.1 EMI CHARACTERIZATION OF RADIO COMMUNICATION STANDARDS**

Every standard allocates frequency bands that may be used by the given technology. Almost all technologies employ frequency division duplex (FDD) signals, i.e. use paired bands for uplink and downlink. Some wireless communication standards also use the time division duplex method (TDD), separating uplink and downlink in predetermined timeslots. Of primary interests for EMI in avionics from internal sources is the uplink spectrum because this is the transmission that will be generated within the aircraft, by the T-PED. The downlink spectrum becomes of interest, if a pico-cell is to be installed on board the aircraft.

The communication standards result in a set of signal waveforms, which represent their EMI potential sufficiently and can be separated in groups by modulation techniques. There are four mainly used access schemes: TDMA, CSMA, FDMA and CDMA scheme. Of these, the main modulation techniques are FM, Phase Modulation, AM or pulse modulation.

### **A.2.2 TRANSMITTING POWER AND FIELD STRENGTH**

For the given standards, usually either the maximum ERP (effective radiated power) or the EIRP (effective isotropic radiated power) are specified, the latter being related to the electric field strength (E) and distance from the antenna (r) in the far field (distances greater than one wavelength) as:

$$E = \sqrt{\frac{EIRP \cdot \eta}{4\pi}} \cdot \frac{1}{r}$$

Where  $\eta = 120\pi \Omega$  is the impedance of free space. For closer distances the Maxwell equations need to be solved, since the fields depend on the type and shape of the source. However, this rigorous approach is highly dependent on the boundary conditions, which may take almost arbitrary values in real life circumstances, which means that the above far-field approximation can still be used even for distances smaller than one wavelength. This approach is consistent with ED-118.

### Criteria for Assessment of the EMI Potential of Radio Communication Standards

The different modulation schemes can be categorized into three classes. They represent different categories of radio signals EMI potential, acknowledging that AM or FM, or PM signals pose different interference risks to electronic circuitry and installations. The criteria defined are based on the following assumptions:

The EMI threat is linked with sudden signal amplitude changes, generally increasing along with the signal amplitude's time derivative.

The main impact on the signals amplitude change is driven by the access schemes of a wireless standard. These access schemes can be separated into TDMA, FDMA or CDMA. TDMA results in PM with fast changes of the time derivative. FDMA and CDMA do not affect the signal amplitude.

Some amplitude modulations such as QAM or AM cause amplitude changes but still no pulse modulation, since these changes are less significant than pulse modulation for the EMI potential.

#### EMI criterion A (Amplitude change):

Pulse Modulation signals are represented with a general PM-type test signal. Pulse modulation safely covers amplitude modulations at the same peak power level, if the pulse repetition frequency (PRF) and the amplitude change frequency are in the same order of magnitude. In this document pulse repetition cycles in the range between 0.5 ms and 50 ms are considered similar in terms of their EMI behaviour (see TDMA, CSMA, M-QAM).

The EMI potential increases along with signal power level. The signal energy has a minor influence. Example: The energy is the product of power and signal-on-time. This way an electronic system can safely be exposed to a considerable amount of energy density provided the power level is low and the signal-on-time is long. In the same way, for pulse modulated signals, the duty cycle plays a minor role, because the influence of the energy ( = power · signal-on-time · duty-cycle ) is less significant than the influence of the power.

#### EMI criterion B (Power and field strength level):

An EMI test signal representing a wireless signal needs to reflect the radio signal's nominal power or field strength level (affects all standards, modulations or access schemes)

The effects of frequency or phase changes due to modulation techniques are negligible. For EMI testing, frequency modulation (FM), binary phase shift keying (BPSK), quadrature phase shift keying (QPSK),  $\pi/4$ -differential quadrature phase shift keying ( $\pi/4$ -DQPSK), frequency shift keying (FSK) and Gaussian minimum shift keying (GMSK) can be represented by continuous waves. This is substantiated by [9].

#### EMI criterion C (Modulation):

If just frequency changes or phase changes occur in the modulation, a continuous wave (CW) EMI test signal sufficiently represents the standards useful signal modulation (see FDMA, CDMA, phase modulation, frequency modulation, BPSK, GMSK, QPSK,  $\pi/4$ -QPSK).

### A.2.3

#### WIRELESS COMMUNICATION STANDARDS

The following sections will present the current most widely used wireless communication standards. They are classified depending on whether they are pulse or amplitude modulated (TDMA, CSMA/CA) or if they are continuous-wave-like (FDMA, CSMA). For each standard a table summarizes its main features, for example frequency bands, the maximum transmitted power, and additionally the maximum electric field strength at a short distance (0.1m) and at a standard distance of 1m.

For additional detailed information about the communication standards see [8-20].

### A.2.3.1 Pulse and Amplitude Modulated Standards

The following table (Table 9) shows all pulse and amplitude modulated standards classified in three groups: mobile phone standards, data communication standards and professional mobile radio standards. For each one of them the modulation type, uplink and downlink frequencies, EMI character field strength at distances of 0,1m and 1m, EIRP, PRF (pulse repetition frequency) and duty cycle are listed. The number of channels is also listed. This is useful for calculating the MEF (Multiple equipment factor) as explained further in A.5.1. It refers to the amount of physical channels (i.e. carrier frequencies) since the number of signals present in the environment is what is important for this calculation for a TDMA system, and not the actual number of transmitters. This will be explained later in more detail. **For all standards the number of transmitters corresponds to specification values of each protocol.** For GSM it is assumed that ground network structures and reuse of channels in the ground network lead to a visibility of less than 25% of the ground network channels within the aircraft. Therefore, just 25 % of the channels are used simultaneously for a worst-case consideration, that all mobile phones were connected without pico-cells or similar system provisions on board the aircraft.

#### EMI characteristic

For each of the modulations the EMI potential is determined by the pulse modulated signal structure caused by the TDMA or CSMA/CA access schemes (depending on the standard), which cause a rapid change of the signal amplitude. Therefore, all these standards can be characterized by **EMI criteria A, B and C**. Inside the pulses, they are all phase modulated, so in a representative test signal for these technologies, it's not necessary to implement the modulation type, since it does not affect the EMI characteristic because it causes no abrupt amplitude changes as it was stated in [9]. In the case that amplitude modulation is also present along with the access scheme, it is expected for the access scheme to cover the amplitude modulation.

#### Radiated electric field strength, transmitted power and resulting waveforms

The electric field strength values used in the calculations for the test signal are the values found at a distance of 0,1m as well as the standard 1m distance for all standards. A 6 dB mandatory safety margin has been applied for the determination of test levels. The same applies for the testing transmitted power value: using the standard values along with a 6 dB mandatory safety margin, if the testing distance is short (~ 0,1m).

**The MOBITECH II along with all the PMR (Professional Mobile Radio) standards are not expected for use inside the aircraft. Therefore, they are not considered for equipment qualification test procedures. However, if the distance between mobile station and equipment equals or exceeds 30 cm, instead of 10 cm, for the short distance between T-PED and equipment, the chosen test levels cover these PMR standards.**

For each modulation an EMI test signal can be represented by a pulse modulated signal with the corresponding PRF and duty cycle. All these results are summarized in Table 10.



**TDMA (pulse-, amplitude modulated) Mobile Phone Standards**

Wireless Standard	Modulation type	Uplink Frequency (MHz)	Downlink Frequency (MHz)	EMI Character	Field strength (r=0.1m) (V/m)	Field strength (r=1m) (V/m)	EIRP (W)	PRF (Hz)	Duty cycle	N. of channels
GSM	GMSK (EDGE: 8PSK)	450,4 – 457,6 (GSM400) 824 – 849 (GSM850) 876 – 915 (GSM900+E+R) 1710 – 1785 (DCS1800) 1850 – 1910 (PCS1900)	460,4 – 467,6 (GSM400) 869 – 894 (GSM850) 921 – 960 (GSM900+E+R) 1805 – 1880 (DCS1800) 1930 – 1990 (PCS1900)	PM (EMI A, B, C)	77 (GSM) 55 (PCS1900, DCS1800)	7,7 (GSM) 5,5 (PCS1900, DCS1800)	2 (GSM) 1 (PCS1900, DCS1800)	217	12,5% (0,576 ms)	9 (GSM400) 32 (GSM850) 32 (GSM900+E+R) 94 (GSM1800) 75 (GSM1900)
i-DEN	16QAM	806 – 825 896 – 901 1453 – 1465	851 – 870 935 – 940 1501 – 1513	PM, AM (EMI A, B, C)	77 (max)	7,7 (max)	2 (max/usual)	11,1 22,2 33,3	16,7% 33,3% (15 ms) 50%	40/MHz
IS-136/ TDMA/DAMPS	$\pi/4$ -DQPSK	824 – 849 (IS-136 and IS-54) 1850 – 1910 (IS-136)	869 – 894 (IS-136 and IS-54) 1930 – 1990 (IS-136)	PM (EMI A, B, C)	55 (AMPS) 42,4 (TDMA)	5,5 (AMPS) 4,24 (TDMA)	1 (AMPS) 600mW (TDMA)	50	16,7% (3,33 ms) 33,3% (6,66 ms)	832 1800
PDC	DQPSK	887 - 889 893 – 901 915 – 958 1477 – 1501	832 – 834 838 – 846 860 – 885 810 – 828 1429 – 1453	PM (EMI A, B, C)	141 (max) 55 (usual)	14,1 (max) 5,5 (usual)	6,6 (max) 1 (usual)	50	16,7% (3,33 ms) 33,3% (6,66 ms)	1600
PHS	$\pi/4$ -DQPSK	1895 – 1918		PM (EMI A, B, C)	7,8 (max)	0,8 (max)	20 mW (max)	200	12,5% (0,625 ms)	300
UMTS TDD (at present not in use)	QPSK	824 - 849, 1850 – 1900 1900 – 1920, 2010 - 2025		PM (EMI A, B, C)	77 (max) 27 (usual)	7,8 (max) 2,8 (usual)	2 (max) 0,25 (usual)	Up to 750	0,66 ms	7

**CSMA/CA (pulse modulated) Data Communication Standards**

Wireless Standard	Modulation type	Uplink Frequency (MHz)	Downlink Frequency (MHz)	EMI Character	Field strength (r=0.1m) (V/m)	Field strength (r=1m) (V/m)	EIRP (W)	PRF (Hz)	Duty cycle	N. of channels
IEEE 802.11 a	BPSK, QPSK, 16QAM, 64QAM, OFDM	5,15 – 5,25 GHz (1) 5,25 – 5,35 GHz (2) 5,725 – 5,825 GHz (3)		PM, AM (EMI A, B, C)	38,7 (w. 6 dBi ant. Gain)	3,9 (w. 6 dBi ant. Gain)	500mW	N/A	4 us (OFDM symbol interval)	12
IEEE 802.11 b, g	BPSK, QPSK (CCK, PBCC)	2,4 – 2,4835 GHz 2,471 – 2,497 GHz 2,4465 – 2,4835 GHz 2,445 – 2,475 GHz		PM (EMI A, B, C)	38,7	3,9	500mW (100 mW is the most prolifersted level, also mandatory upper limit in the Europe)	N/A	20 us (Slot time)	3 (non overlapping)
ZigBee (IEEE 802.15.4)	BPSK, OQPSK	868 – 868,6 902 – 928 2400 – 2483,5		PM (EMI A, B, C)	11 (max) (with 6 dBi ant. gain)	1,1 (max) (with 6 dBi ant. gain)	2 mW – 40 mW (with. 6 dBi ant. gain)	N/A	15 ms (Slotted CSMA/CA)	1 (for 868 MHz) 10 (for 915 MHz) 16 (for 2,4 Ghz)
Bluetooth	GFSK	2.402 - 2.480 GHz (1) 2.447 - 2.473 GHz (2) 2.448 - 2.482 GHz (3) 2.473 - 2.495 GHz (4)		PM (EMI A, B, C)	17,3 (max) (1) 3 (max) (2) 2 (max) (3)	1,73 (max) (1) 0,3 (max) (2) 0,2 (max) (3)	100 mW (1) 2,5 mW (2) 1 mW (3)	1600	89,28 us	79 (1) 23 (2) (3) (4)

**TDMA (pulse modulated) Professional Mobile Radios (PMR)**

Wireless Standard	Modulation type	Uplink Frequency (MHz)	Downlink Frequency (MHz)	EMI Character	Field strength (r=0.1m) (V/m)	Field strength (r=1m) (V/m)	EIRP (W)	PRF (Hz)	Duty cycle	N. of channels
TETRA	$\pi/4$ -DQPSK	380 – 390 410 – 420 450 – 460 870 – 888	390 – 400 420 – 430 460 – 470 915 – 933	PM (EMI A, B, C)	220 (max)	22 (max)	16 (max/usual)	17,6	25% (14,167 ms)	18

**Table 9 : Pulse, amplitude modulated standards**

### TDMA (pulse-, amplitude modulated) Mobile Phone Standards

Wireless Standards	Signal waveform	Recommended test field strength level (V/m)	Recommended test trans. power (W) EIRP
GSM	<p>Repetition time = <math>8 \cdot 0.576</math> ms</p> <p>Pulse duration = 0.576 ms</p>	154 (GSM)* 110 (PCS1900, DCS1800)*  15,4 (GSM)* 11 (PCS1900, DCS1800)**	8 (GSM) 4 (PCS1900, DCS1800)
i-DEN	<p>Repetition time = 30, 45, 90 ms</p> <p>Duty cycle = 15 ms, with 16 kHz Amplitude Modulation (50% maximum)</p>	154* 15,4**	8
IS-136/ TDMA/DAMPS	<p>3.33 ms or 6.66 ms</p> <p>20 ms time frame = <math>6 \cdot 3.33</math> ms or <math>3 \cdot 6.66</math> ms</p>	110 (AMPS)* 11 (AMPS)**  85 (TDMA)* 8,5 (TDMA)**	4 (AMPS) 2,4 (TDMA)
PDC	<p>3.33 ms or 6.66 ms</p> <p>20 ms time frame</p>	110* 11**	4
PHS	<p>0.625 ms</p> <p>5 ms = <math>8 \cdot 0.625</math> ms</p>	15,6* 1,6**	80 mW

UMTS TDD (at present not in use)		54* 5,4**	1
-------------------------------------	--	--------------	---

**Table 10 : Radiated field, radiated power and resulting waveforms for pulse, amp. modulated standards**

**CSMA/CA (pulse modulated) Data Communication Standards**

Wireless Standards	Signal waveform	Recommended test field strength level (V/m)	Recommended test transm. power (W) EIRP
IEEE 802.11 a		110* 11**	4 W
IEEE 802.11 b		49* 4,9**	800mW***
ZigBee (IEEE 802.15.4)		22* 2,2**	160 mW

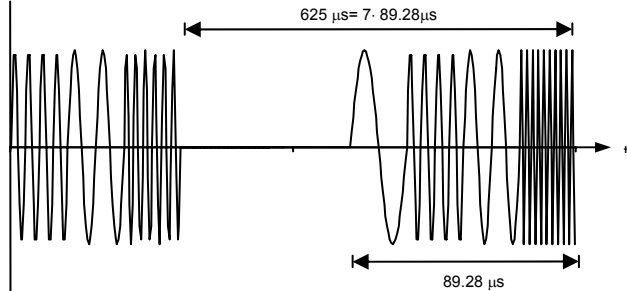
Bluetooth		<p>35 (1)* 6 (2)* 4 (3)*</p> <p>3,5 (1)** 0,6 (2)** 0,4 (3)**</p>	<p>400 mW (1) 10 mW (2) 4 mW (3)</p>
-----------	---	---	--

**TDMA (pulse modulated) Professional Mobile Radios (PMR)**

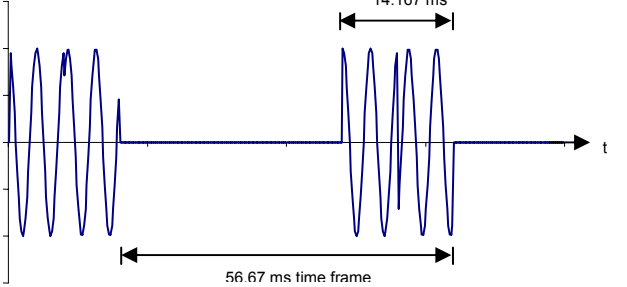
Wireless Standards	Signal waveform	Recommended test field strength level (V/m)	Recommended test transm. power (W) EIRP
TETRA		<p>440* 44**</p>	<p>64</p>

**Table 10 (continuation) : Radiated field, radiated power and resulting waveforms for pulse, amp. modulated standards**

\* r = 0,1 m

\*\* r = 1 m

\*\*\* The European standard allows a maximum of 100mW transmitted power for the IEEE 802.11 b,g. On the US market there are a few devices with up to 500mW. However, these are rare .In the very rare case they should be used onboard aircraft, the 800mW testing limit provides an adequate safety margin.

### Test Signal (EMI Character of TDMA and CSMA/FHSS Standards)

The EMI test signal for equipment qualification tests should provide a pulse modulation with a PRF in the range of 200 Hz and a small duty cycle in the range of 625  $\mu$ s, which are considerably useful values for these parameters. This signal is, according to **EMI criterion A**, sufficiently similar to cover all the investigated signal waveforms presented in Table 9 and Table 10. With the values from these tables along with the corresponding frequency bands for each standard, the required field strength levels and power levels for retrofit qualification (full aircraft testing) are shown along the frequency spectrum in A.2.5, from Figure 14 to Figure 17. With these required levels, a mask or envelope is then constructed for the field strength and power levels, as shown in A.2.6, Figure 18 to Figure 21. This envelope gives the test levels for a frequency range between 300 MHz and 6 GHz, meaning that these levels are the ones used for laboratory equipment qualification.

The signal modulation (BPSK, QPSK, FSK etc.) occurring during the duty cycle, according to **EMI Criterion C**, has no additional influence on the EMI character of a signal, which was found valid according to [9]. During the duty cycle, a continuous wave signal is therefore adequate, and the rapid changes in amplitude are covered by the pulse modulation. Therefore, the test waveform according to Figure 12 covers the EMI characteristic of the TDMA and CSMA standards investigated above.

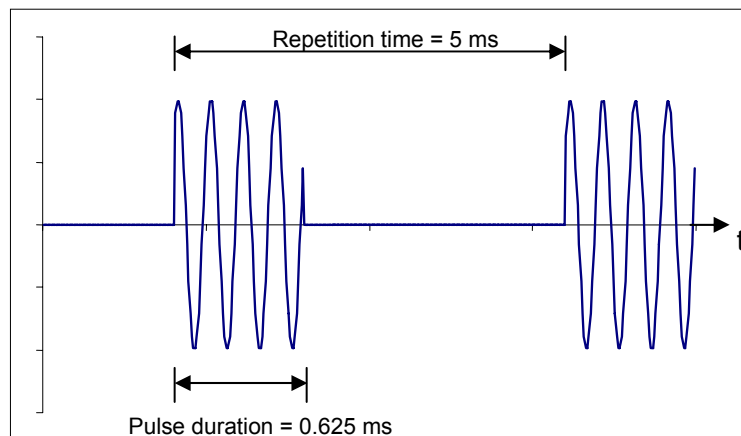

**FIGURE 12 : TEST WAVEFORM FOR STANDARDS USING TDMA OR CSMA/FHSS SCHEMES**

#### EMI characteristic:

Adequate test levels for laboratory equipment qualification depend on both, the standard and possible distance between device and equipment under test. They are given in A.2.6, like said before, and are to be applied in connection with the test procedures discussed in ANNEX 3.

#### A.2.3.2 FDMA/CDMA and other CW-like Standards

The following table (Table 11) shows all FDMA/CDMA (CW-like) standards classified in three groups: mobile phone standards, data communication standards and professional mobile radio standards, as was done in the previous case. For each one of them the modulation type, uplink and downlink frequencies, EMI character, field strength at distances of 0,1m and 1m, and EIRP. The number of channels is also listed. This is useful for calculating the MEF (Multiple equipment factor) as explained in A.5.1. It refers to the amount of physical channels (i.e. carrier frequencies) since the number of signals present in the environment is what is important for this calculation. This will be explained later in more detail. **For all standards the number corresponds to specifications values of each protocol.**

**EMI characteristic**

For each of the modulations the EMI potential is determined by the level of the continuous wave-like signal structure caused by the FDMA or CDMA access schemes (depending on the standard), which are characterized by constant signal amplitude. Therefore, all these standards can be characterized by **EMI criteria B and C**. From the standards analysed here, all are phase or frequency modulated (some CDMA standards also include amplitude modulation), so in a representative test signal for these technologies, it's not necessary to implement the modulation type since it does not affect the EMI characteristic because it causes no amplitude changes as it was stated in [9]. A representative test signal should be then a continuous wave signal.

**Radiated electric field strength, transmitted power and resulting waveforms**

The electric field strength values used in the calculations for the test signal are the usual values found at a distance of 0,1m, as well as 1m for all standards. Along with a 6 dB mandatory safety margin, a test signal can be determined for each case. The same applies for the testing transmitted power value: using the usual values along with a 6 dB mandatory safety margin, if the testing distance is short (~ 0,1m).

**The MOBITECH II along with all the PMR (Professional Mobile Radio) standards are not expected for use inside the aircraft. Therefore, they are not considered for equipment qualification test procedures. However, if the distance between mobile station and equipment amounts 30 cm, instead of 10 cm, for the short distance between T-PED and equipment, the chosen test levels cover these PMR standards.**

For each modulation an EMI test signal can be represented by a continuous wave signal. All these results are summarized in Table 12.

**FDMA/CDMA (CW-like) Mobile Phone Standards**

Wireless Standard	Modulation type	Uplink Frequency (MHz)	Downlink Frequency (MHz)	EMI Character	Field strength (r=0.1m) (V/m)	Field strength (r=1m) (V/m)	EIRP (W)	N. of channels
CDMA2000	QPSK/OQPSK	410 – 420; 450 – 460 479 – 484; 776 – 794 806 – 849; 870 – 925 1710 – 1785; 1850 – 1910 1920 – 1980	420 – 430; 460 – 470 489 – 494; 746 – 764 832 – 834; 835 – 946 915 – 960; 1805 – 1880 1930 – 1990; 2110 – 2117	CW (EMI B, C)	70 (BC0 = Class III) 55 (BC1 = Class III)	7 (BC0 = Class III) 5,5 (BC1 = Class III)	1,65 (BC0 = Class III) 1 (BC1 = Class III)	20
UMTS FDD	QPSK	824 – 849 1850 – 1910 1920 – 1980	869 – 894 1930 – 1990 2110 – 2170	CW (EMI B, C)	110 (max) 27 (usual)	11 (max) 2,74 (usual)	4 (max) 0,25 (usual)	12
NAMPS/AMPS	FM	824 – 849	869 – 894	CW (EMI B, C)	141 (max) 55 (usual)	14,1 (max) 5,5 (usual)	6,6 (max) 1 (usual)	NAMPS: 2496 AMPS: 832
CDMAone	BPSK	824 – 849 1850 – 1910	869 – 894 1930 – 1990	CW (EMI B, C)	70 (BC0 = Class III) 55 (BC1 = Class III)	7 (BC0 = Class III) 5,5 (BC1 = Class III)	1,65 (BC0 = Class III) 1 (BC1 = Class III)	20

**FDMA Data Communication Standards**

Wireless Standard	Modulation type	Uplink Frequency (MHz)	Downlink Frequency (MHz)	EMI Character	Field strength (r=0.1m) (V/m)	Field strength (r=1m) (V/m)	EIRP (W)	N. of channels
MOBITEX II	GMSK	415 – 430 820 – 870 895 – 910		CW (EMI B, C)	110 (max)	11 (max)	4 (max/usual)	20

**FDMA (CW-like) Professional Mobile Radios**

Wireless Standard	Modulation type	Uplink Frequency (MHz)	Downlink Frequency (MHz)	EMI Character	Field strength (r=0.1m) (V/m)	Field strength (r=1m) (V/m)	EIRP (W)	N. of channels
PMR446	FM	446		CW (EMI B, C)	49 (max)	4,9 (max)	0,8 (max/usual)	8
Project25/ APCO25	C4FM/ QPSK	130 – 200 360 – 512 800 – 941		CW (EMI B, C)	173 (max)	17,3 (max)	10 (max/usual)	N/A, depends on modulation technique
MPT-1327	FFSK	Any approved for mobile communication		CW (EMI B, C)	220 (max)	21,9 (max)	16 (max)	N/A
TETRAPOL	GMSK	70 – 520 746 – 888 915 – 933		CW (EMI B, C)	110 (max)	11 (max)	4 (max/usual)	4 – 8
EDACS	GMSK	136 – 174 (1) 380 – 512 (2) 806 – 821 (3) 851 – 866 (4) 896 – 901 (5)		CW (EMI B, C)	173 (max)	17,3 (max)	10 (max/usual)	1520 (1) 5280 (2) 1200 (3) (4) 400 (5)

**Table 11 : FDMA/CDMA (CW-like) standards**

## FDMA/CDMA (CW-like) Mobile Phone Standards

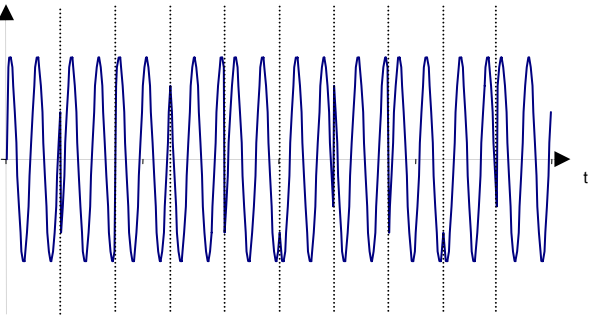
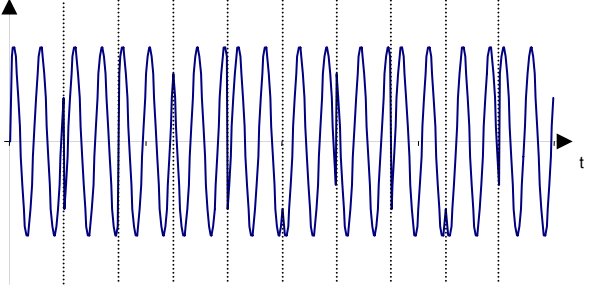
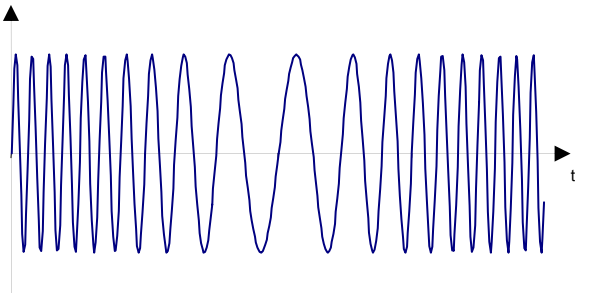
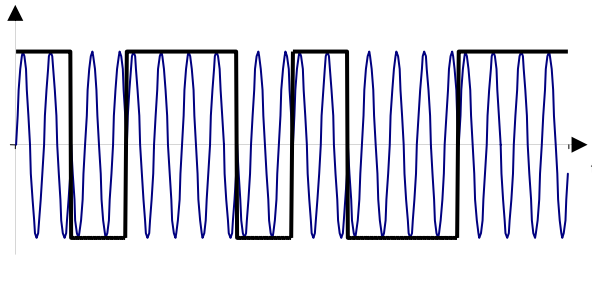
Wireless Standards	Signal waveform	Recommended test field strength level (V/m)	Recommended test transm. power (W) EIRP
CDMA2000		140 (BC0 = Class III)* 110 (BC1 = Class III)*  14 (BC0 = Class III)** 11 (BC1 = Class III)**	6,6 (BC0 = Class III) 4 (BC1 = Class III)
UMTS FDD		54* 5,4**	1
NAMPS/AMPS		110* 11**	4
CDMAone		140 (BC0 = Class III)* 110 (BC1 = Class III)*  14 (BC0 = Class III)** 11 (BC1 = Class III)**	6,6 (BC0 = Class III) 4 (BC1 = Class III)

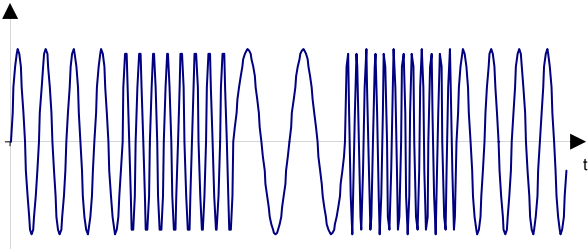

**FDMA Data Communication Standards**

Wireless Standards	Signal waveform	Recommended test field strength level (V/m)	Recommended test transm. power (W) EIRP
MOBITEX II		220* 22*	16

**Table 12 : Radiated field, radiated power and resulting waveforms for FDMA/CDMA (CW-like) standard**

**FDMA (CW-like) Professional Mobile Radios**

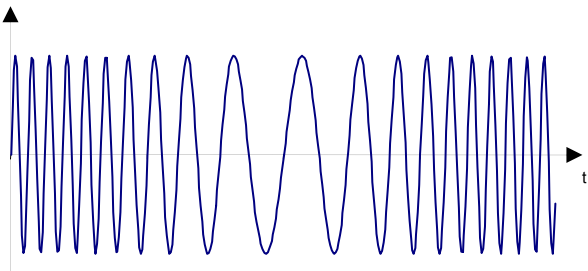
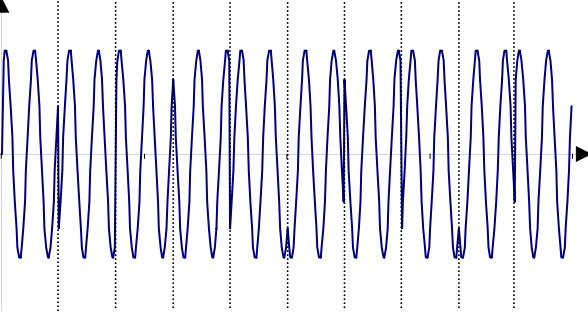
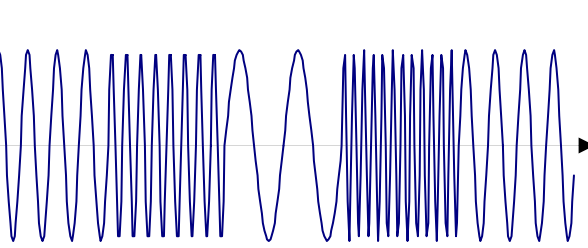
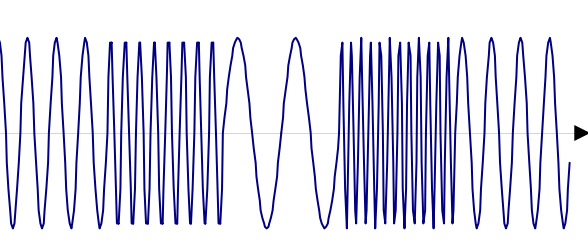
Wireless Standards	Signal waveform	Recommended test field strength level (V/m)	Recommended test transm. power (W) EIRP
PMR446		98* 9,8**	3,2
Project25/ APCO25		346* 34,6**	40
MPT-1327		440* 43,8**	64
TETRAPOL		220* 22**	16

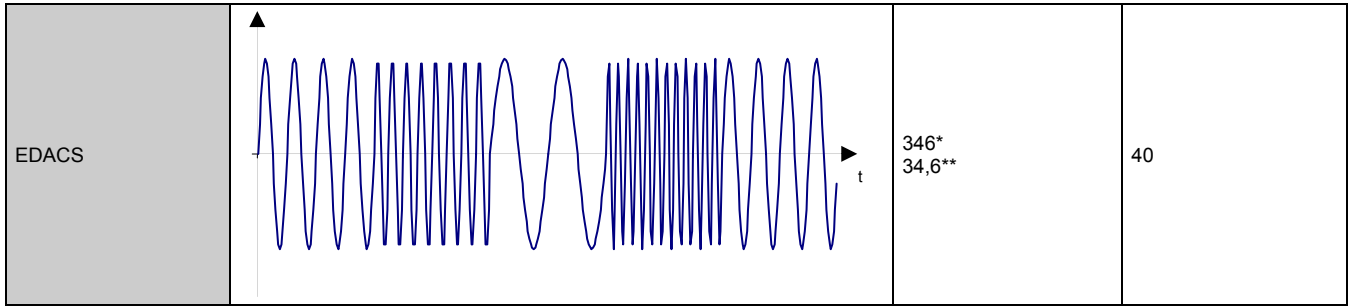

\*  $r = 0,1 \text{ m}$

\*\*  $R = 1 \text{ M}$

**Table 12 (continuation) : Radiated field, radiated power and resulting waveforms for FDMA/CDMA (CW-like) standards**

### Test Signal (EMI Character of CDMA/FDMA Mobile Phone Standards)

In order to specify an appropriate waveform for the equipment qualification test procedure the signal characteristics of CDMA/FDMA standards have been investigated. The following signal covers a wide class of investigated signal waveforms presented in Table 11 and Table 12. With the values from these tables along with the corresponding frequency bands for each standard, the required field strength levels and power levels for retrofit qualification (full aircraft testing) are shown along the frequency spectrum in A.2.5, from Figure 14, Figure 17. With these required levels, a mask or envelope is then constructed for the field strength and power levels, as shown in A.2.6, Figure 18 to Figure 21. This envelope gives the test levels for a frequency range between 300 MHz and 6 GHz, meaning that these levels are the ones used for laboratory equipment qualification.

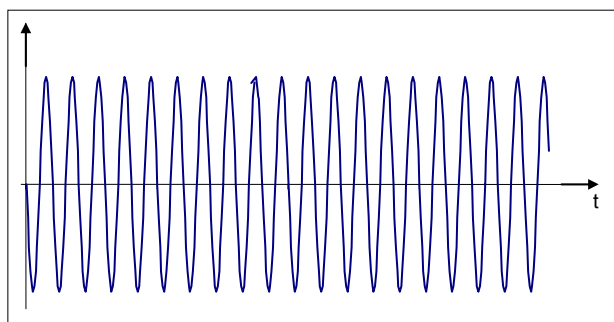

**FIGURE 13 : CW-WAVEFORM FOR STANDARDS PROVIDING NO PULSE MODULATION**

#### EMI characteristic:

The EMI test signal for standards with FDMA or CDMA scheme can be characterized by **EMI criterion B** and **EMI criterion C**.

The CDMA/FDMA standards EMI behaviour is sufficiently represented by the continuous waveform according to Figure 13. Adequate test levels depend on both the standard and the possible distance between device and equipment under test, meaning that the levels need to be chosen together with the adequate test procedure (see ANNEX 3).

#### A.2.4

#### CONCLUSION ON TEST SIGNAL WAVEFORMS

The investigation of several radio communication standards and the application of the EMI criteria for several modulations resulted in two basic signal waveforms adequate to qualify equipment against the environmental impact due to radio communication services.

One signal waveform reflects the widely used pulse modulation (TDMA) behavior of the most popular mobile communication standards, GSM. The other waveform is a simple continuous wave as already used today within ED-14/DO160D and E. This continuous wave represents the EMI potential of the CW-like radio communication standards which have no amplitude changing features, neither in their access schemes nor in their signal modulation principle.

The evaluation of adequate test levels is inherently done in the previous sections, but the levels depend on the potential distance between the T-PED and the equipment under test and on the test procedure. This will be treated in the following section.

## A.2.5 REQUIRED FIELD STRENGTH LEVELS AND POWER LEVELS

For retrofit testing, it is adequate to select the radio standard, which is expected on board aircraft specified in 9 and/or 11. Figure 16 shows adequate power test levels for a close distance ( $\sim 0.1$  m) test procedure between EUT and T-PED for the pulse-modulated waveform.

Figure 17 shows the same for the CW-like waveforms.

For *full aircraft testing*, it is mandatory to evaluate the multiple equipment effect of a given number of simultaneous T-PED sources used inside the aircraft. In addition the entire fuselage cross-section needs to be sufficiently illuminated. This is ensured by applying of the Multiple Equipment Factor (MEF) evaluation (see A.5.1).

The values presented in Table 9 and Table 11 include no margin. Hence for the first step of the aircraft testing process (see Figure 24) the standards values according to these tables shall be taken as a base level, where the amplification factor MEF has to be added (see Figure 24).

In addition an evaluation of the functionality of pico-cells is adequate, as the protocols of such radio communication systems may in general allow power setting of T-PEDs and have the option to reduce this way the possible impact of radio signals. Other systems may prevent in addition the unwanted transmission of mobile phones to ground located base stations.

For *laboratory equipment qualification* the values out of tables 10 and 12 are recommended. They already include a six dB margin and nothing needs to be added.

For field strength testing the qualification values are displayed for equipment, which may be located at short range ( $\sim 0.1$  m) between EUT and electronic device. For higher distance ( $> 1$  m) between EUT and electronic device a test level of  $\sim 20$  V/m is adequate (Figure 14 and Figure 15).

With the required levels, shown in this section, a mask or envelope is constructed for the field strength and power levels, as shown in A.2.6, Figure 18 to Figure 21. This envelope gives the test levels for a frequency range between 300 MHz and 6 GHz used for laboratory equipment qualification.

The below displayed power levels are to be used for the *transmitted power test procedure*. They refer to a single T-PED illuminating a device from a close distance of 10 cm.

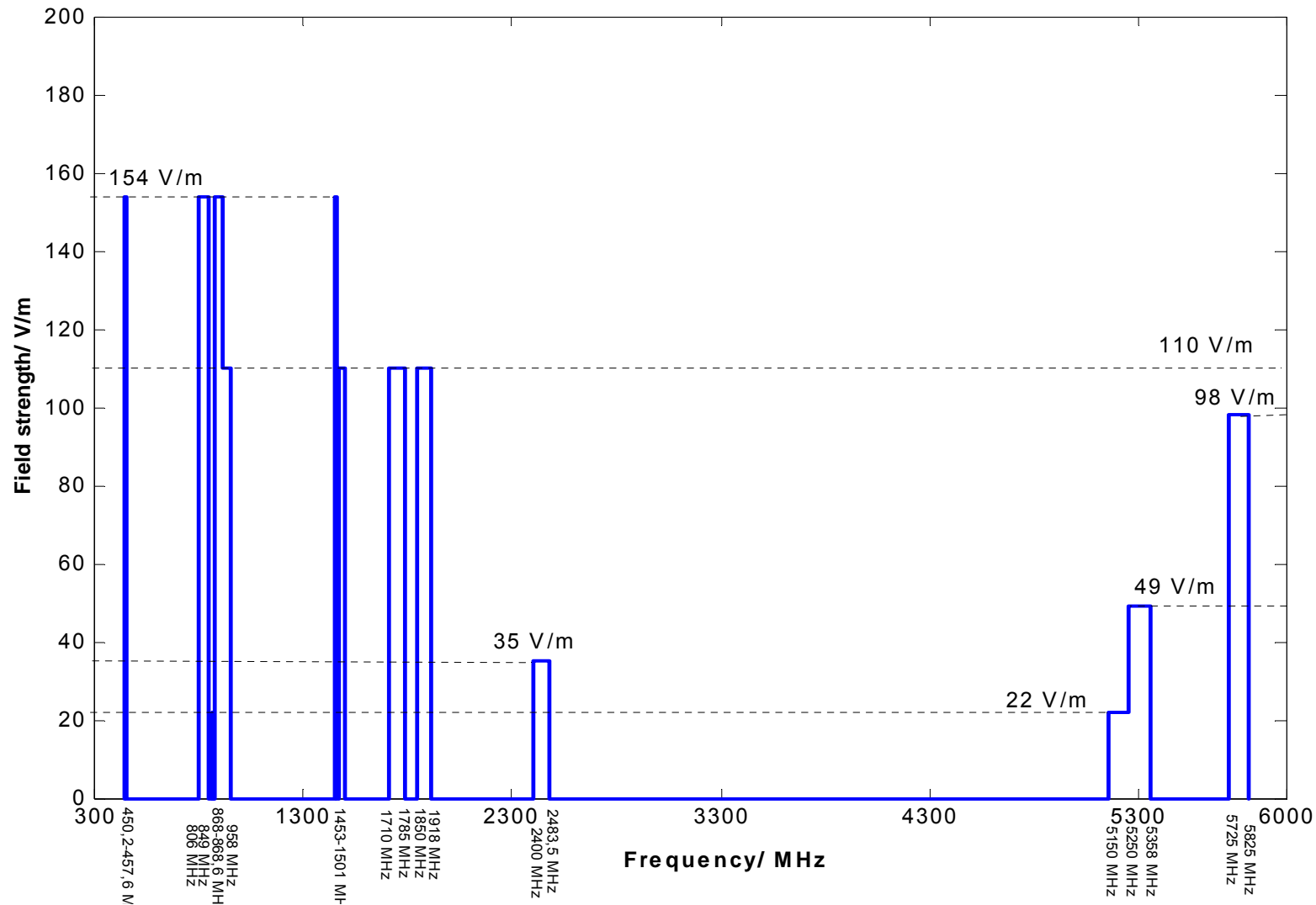

**FIGURE 14 : REQUIRED FIELD STRENGTH LEVELS ONTO EUT FOR WORST-CASE SCENARIO FOR PULSE-MODULATED T-PED SIGNALS INCLUDING 6DB MARGIN**

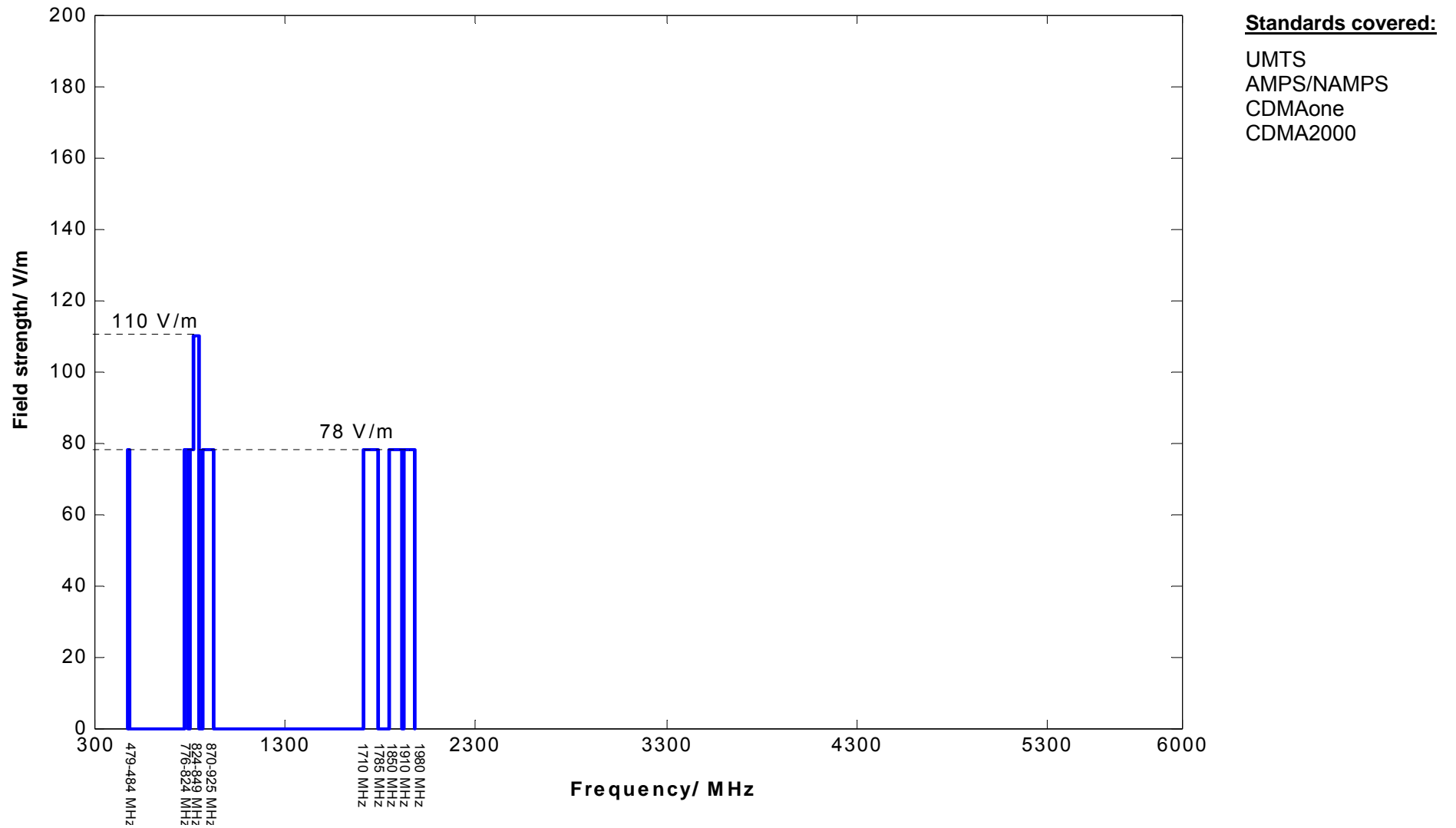

**FIGURE 15 : REQUIRED FIELD STRENGTH LEVELS ONTO EUT FOR CW-LIKE T-PED SIGNALS INCLUDING 6DB MARGIN**

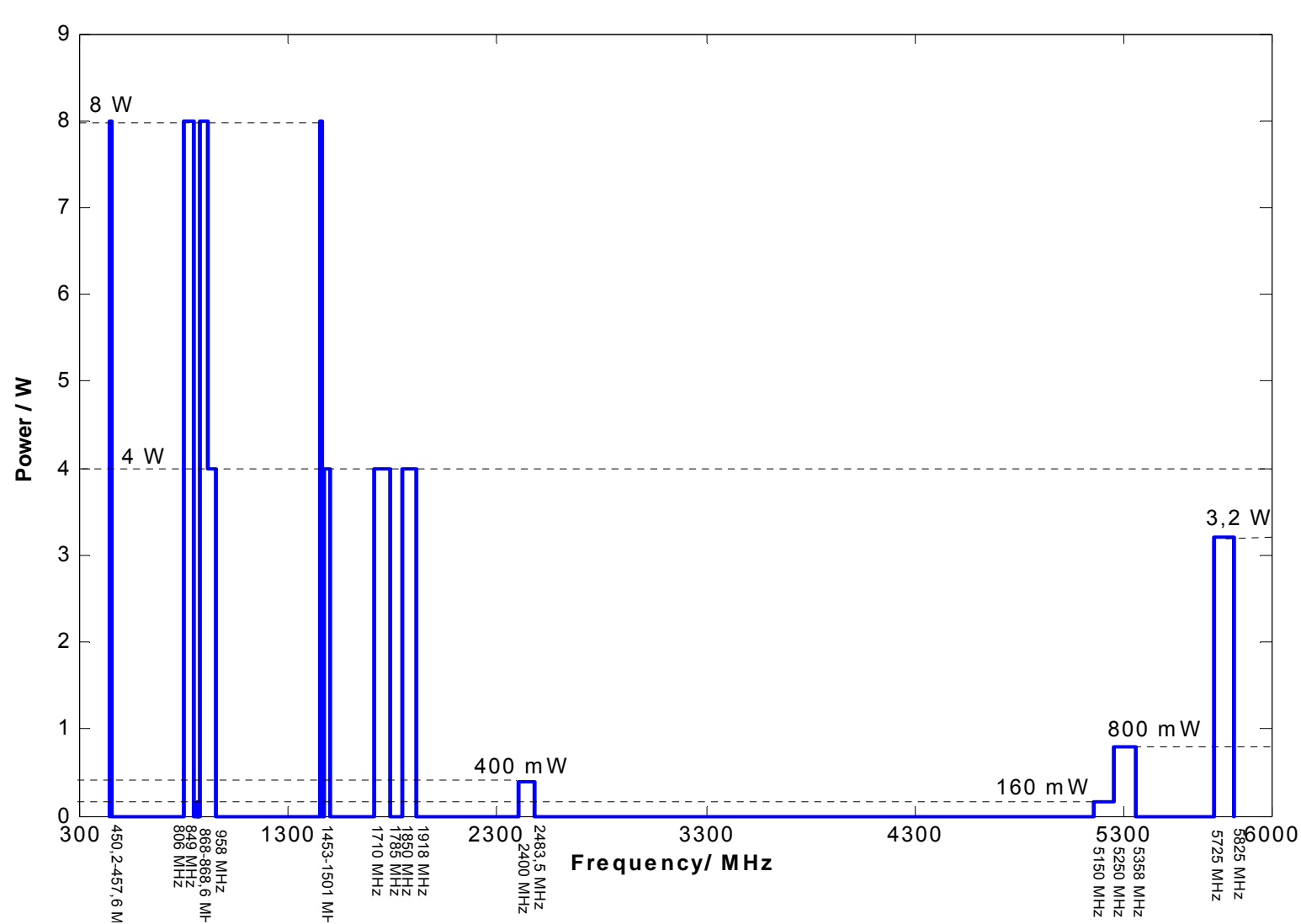

**FIGURE 16 : REQUIRED POWER LEVELS AT A 0.1 M DISTANCE BETWEEN TEST ANTENNA AND EUT FOR PULSE MODULATED (TDMA) T-PED SIGNALS INCLUDING 6DB MARGIN**

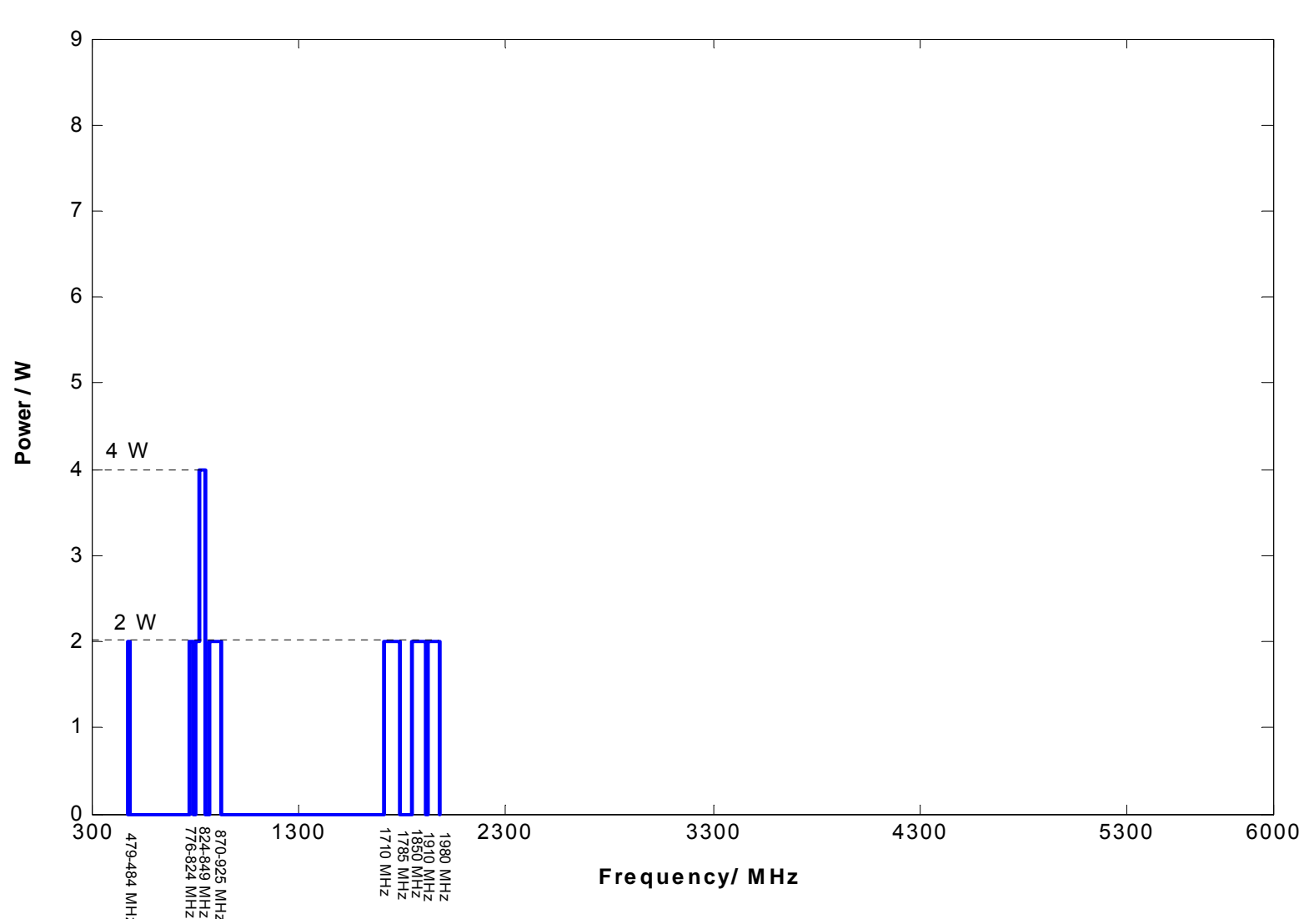

**FIGURE 17 : REQUIRED POWER LEVELS AT A 0.1 M DISTANCE BETWEEN TEST ANTENNA AND EUT FOR CW-LIKE (FDMA) T-PED SIGNALS INCLUDING 6DB MARGIN**



## A.2.6 REQUIRED POWER LEVEL AND FIELD STRENGTH ENVELOPES FOR LABORATORY EQUIPMENT QUALIFICATION

**For equipment qualification**, it is adequate to cover the entire continuous frequency range where a radio service may operate. This inherently includes the EMC radio susceptibility qualification between devices on board, and may even cover HIRF threat scenarios affecting the aircraft from the outside, therefore experiencing attenuation due to the aircraft's hull. In the past, moderate radio susceptibility qualification levels covering HIRF inside the aircraft were adequate. Continuous limits are proposed here for equipment qualification covering the impact from radio transmission services inside the aircraft as well as the external threat.

The mask or envelope shown was constructed for the field strength and power levels, as shown in A.2.6, Figure 18 to

Figure 21 with the required levels for retrofit qualification from A.2.5. This envelope gives the test levels for a frequency range between 300 MHz and 6 GHz used for laboratory equipment qualification.

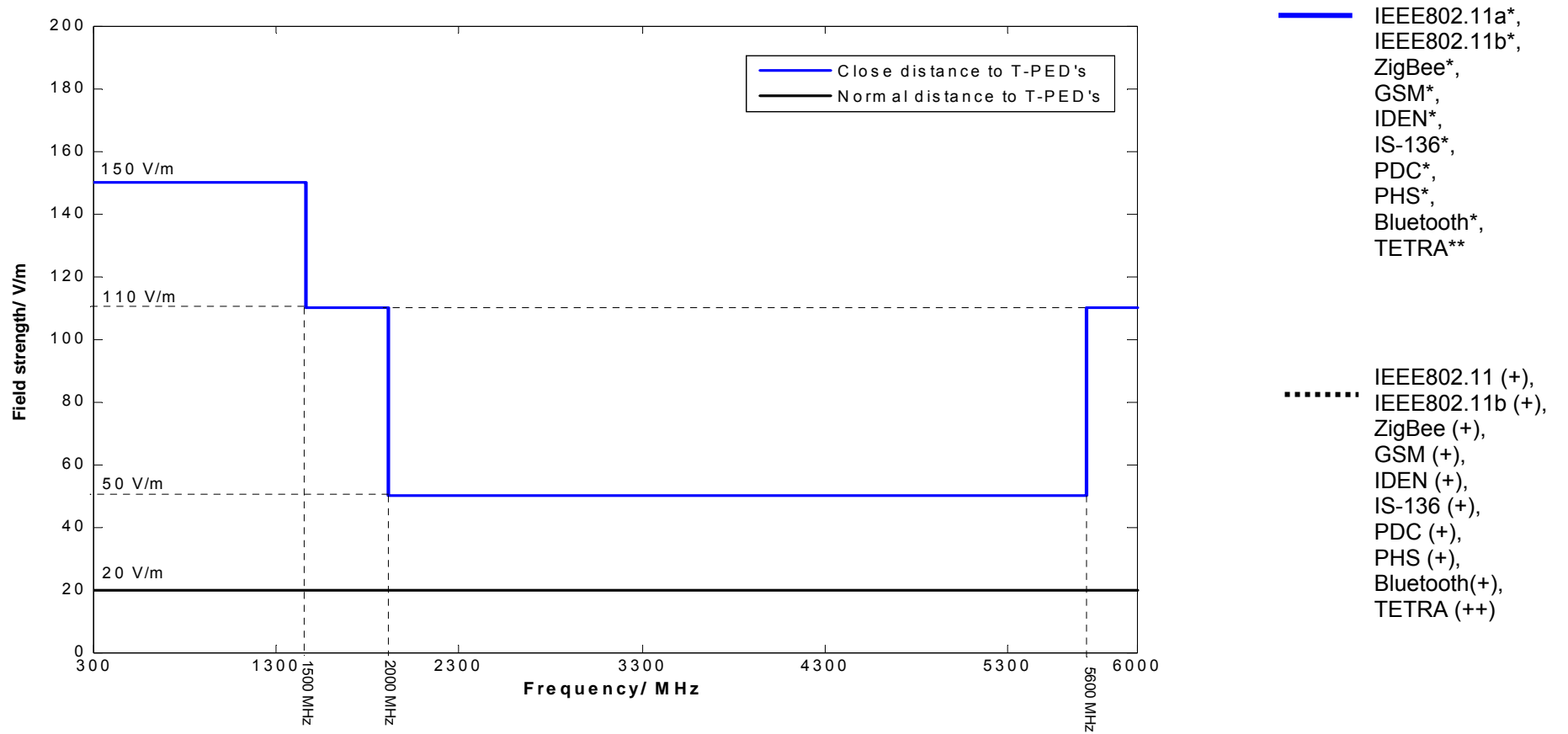

**FIGURE 18 : REQUIRED RADIATED FIELD STRENGTH LEVELS FOR PULSE-MODULATED (TDMA) T-PED SIGNALS INCLUDING 6 DB MARGINS FOR LABORATORY EQUIPMENT QUALIFICATION**

\* Level for equipment in a distance 0.1 m...1 m to T-PED's  
 \*\* Level for equipment in a distance 0,3 m... 2,5 m to T-PED's  
 (+) Level for equipment in a distance > 1 m to T-PED's  
 (++) Level for equipment in a distance > 2,5 m to T-PED's

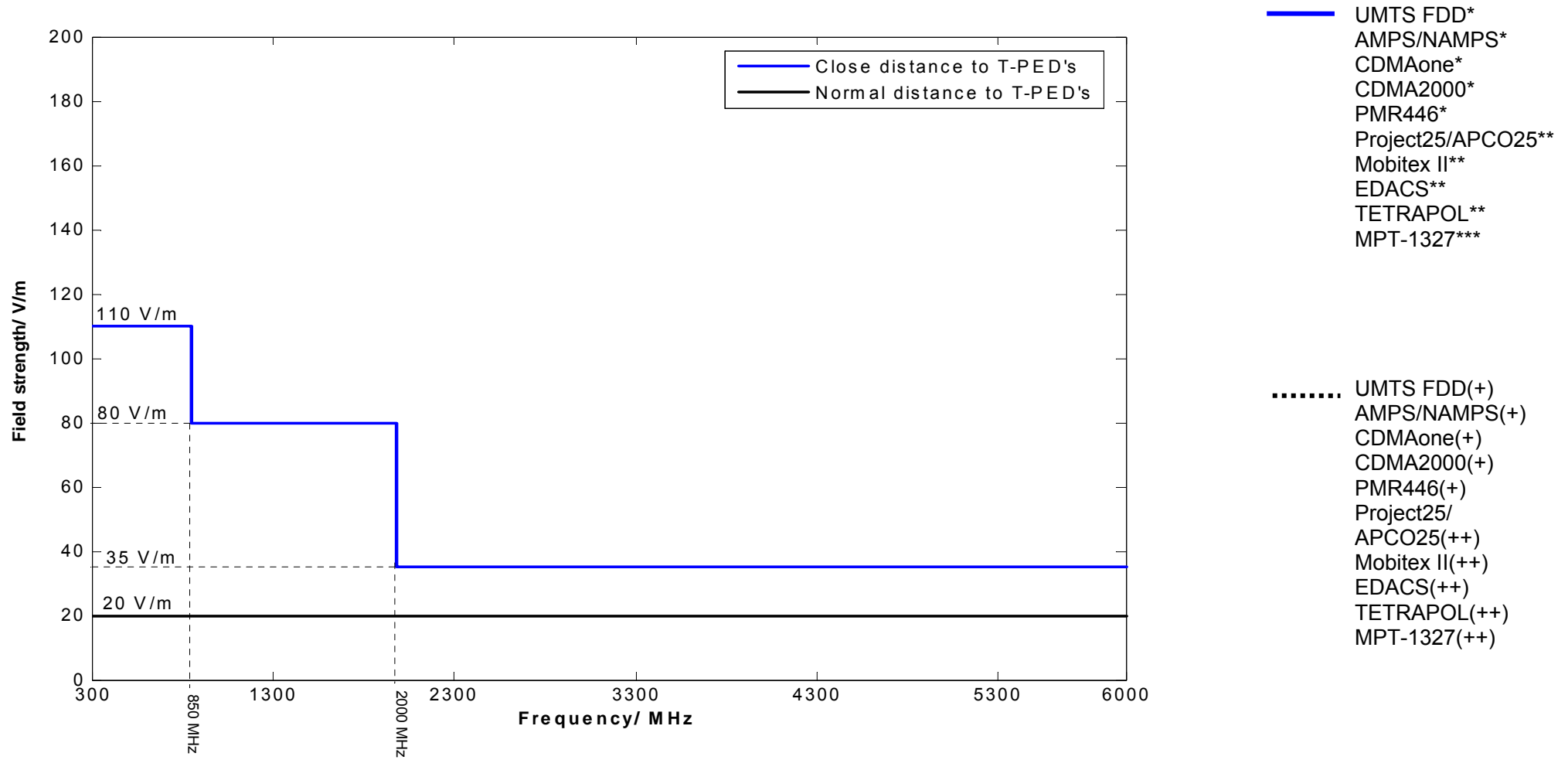

**FIGURE 19 : REQUIRED RADIATED FIELD STRENGTH FOR CW-LIKE (FDMA) T-PED SIGNALS INCLUDING 6 DB MARGINS FOR LABORATORY EQUIPMENT QUALIFICATION**

\* Level for equipment in a distance 0.1 m... 1 m to T-PED's  
 \*\* Level for equipment in a distance 0,4 m... 2,5 m to T-PED's  
 \*\*\* Level for equipment in a distance 0,6 m... 2,5 m to T-PED's  
 (+) Level for equipment in a distance > 1 m to T-PED's  
 (++) Level for equipment in a distance > 2,5 m to T-PED's

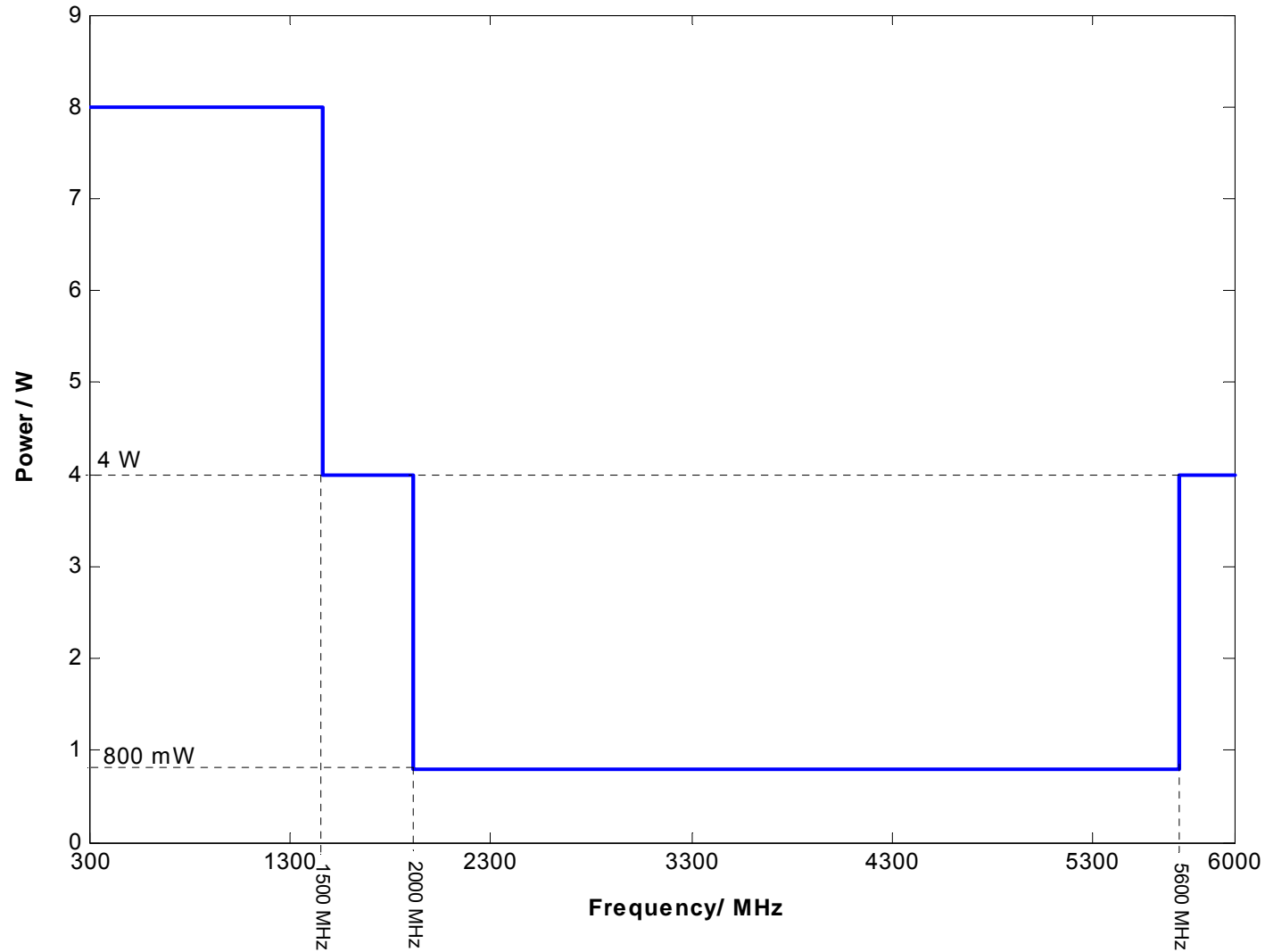
**Standards covered:**

IEEE802.11a  
IEEE802.11b  
ZigBee  
GSM  
IDEN  
IS-136  
PDC  
PHS  
Bluetooth

**FIGURE 20 : REQUIRED RADIATED POWER LEVELS FOR 0.1M DISTANCE BETWEEN TEST ANTENNA AND EUT FOR PULSE-MODULATED (TDMA) T-PED SIGNALS INCLUDING 6 DB MARGINS FOR LABORATORY EQUIPMENT QUALIFICATION**

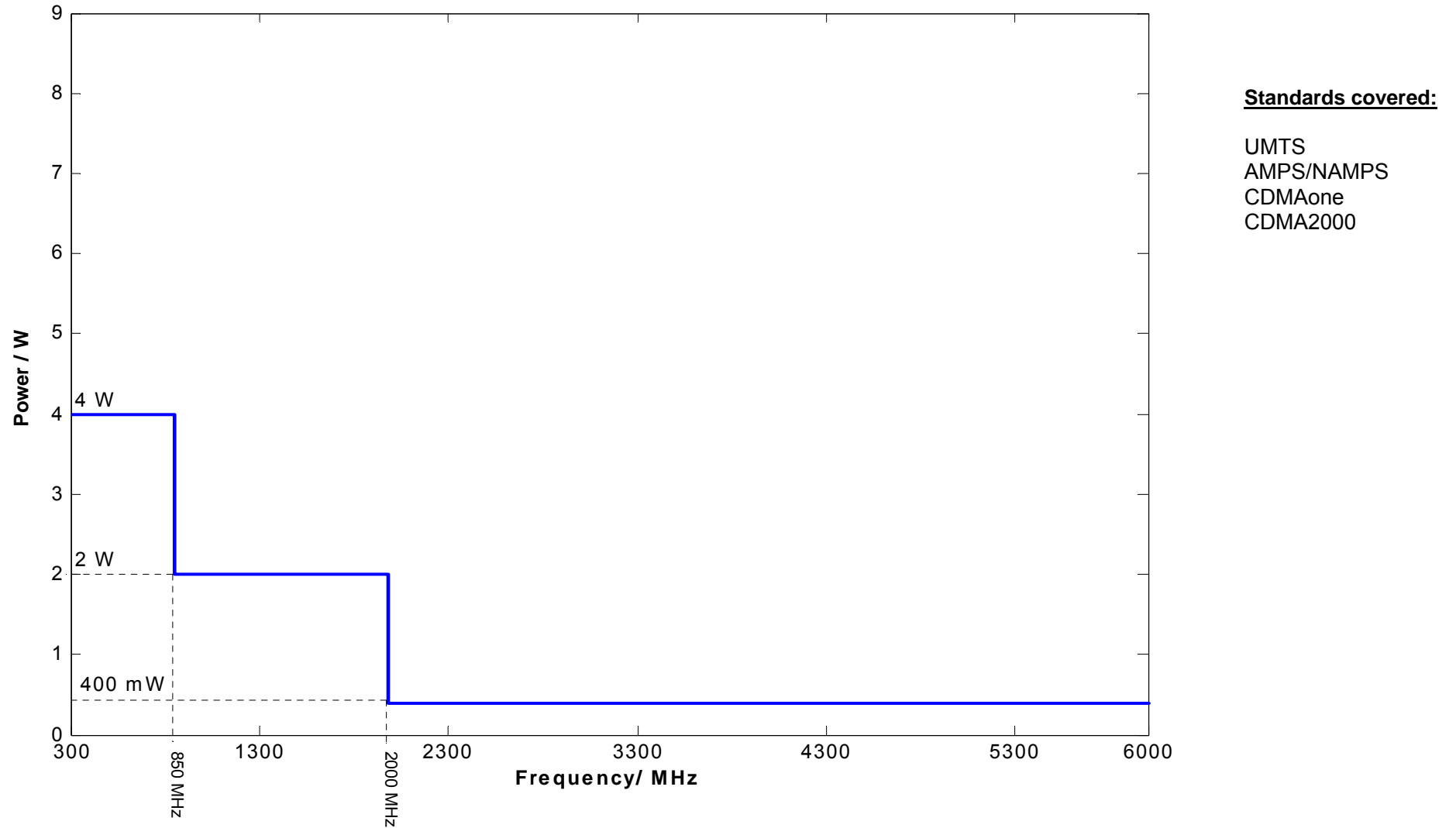

**FIGURE 21 : REQUIRED RADIATED POWER LEVELS FOR 0.1M DISTANCE BETWEEN TEST ANTENNA AND EUT FOR CW-LIKE (FDMA) T-PED SIGNALS INCLUDING 6 DB MARGINS FOR LABORATORY EQUIPMENT QUALIFICATION**

## A.2.7

**CONCLUSION**

Usually, aircraft equipment is qualified against both radiated and conducted RF susceptibility to ensure that abnormal behaviour is not experienced due to interference effects being caused by the RF environment which covers both the HIRF threat and also the RF electromagnetic compatibility between the aircraft systems and equipment. For this purpose, a general test procedure, levels and test signal waveforms are described in the RTCA standard ED-14/DO160D or ED-14/DO160E section 20.

Where the HIRF qualification has not been used during the aircraft equipment qualification or system certification because interference free operation is not required, the aircraft equipment qualification may demonstrate a lower level of RF susceptibility qualification identified as Category "S". This category is intended as a minimum test level where aircraft effects from the external electromagnetic environment are minor and where interference free operation on the aircraft is desirable but not required. This category of qualification is therefore not applicable to equipment whose systems are required for type certification or by the operating rules, or whose improper functioning would reduce safety where interference free operation is a qualification requirement. The category may also be representative of the internal EMI environment from aircraft equipment.

Categories Y (200 V/m between 100 MHz and 8 GHz) and W (100 V/m between 100MHz and 8 GHz) continuous wave signals, within ED-14/DO160D & E, may be considered sufficient to demonstrate EMC of the standards UMTS (FDD), AMPS (NAMPS), CDMAone (IS95) and CDMA2000 at their maximum power level, considering potential close distance scenarios of less than 0.1m between the equipment under test and the T-PED.

MOBITEX II, MPT-1327, TETRAPOL, EDACS Project 25/APCO25 and PMR 446 are covered for higher distances (see standard evaluation). Tetrapol is not covered in the frequency range between 70 MHz and 300 MHz. EDACs is not covered between 136 and 174 MHz, Project 25/APCO25 is not covered between 130 –200 MHz.

Over testing is likely in the frequency range beyond 2 GHz if categories Y or W are applied for equipment qualification. A reduced qualification level of 35 V/m for the range between 2 GHz and 6 GHz is adequate and covers the use of applications transmitting CW-like signals at 100mW, for example within the 2.4-2.5 GHz ISM band. The resulting recommended test level for close distances is given in A.2.6. For equipment installed in a higher distance to possible T-PED locations the lower limit is sufficient. This all is valid for CW-like test signals.

Comparing field strength level from the investigated mobile communication standards against ED-14/DO160D,E section 20, one can derive that cat. R safely covers the qualification against T-PEDs inside the cabin. However, over testing is very likely in a wide frequency band.

For pulse modulated radio communication standards, a different pulse modulated waveform is proposed. For this waveform the qualification levels according to A.2.6, Figure 18, cover the standards GSM, i-DEN, IS-136/DAMPS, PDC, PHS, IEEE802.11b,g, IEEE 802.11a, ZigBee and Bluetooth for a close distance up to 0.1 m between EUT and T-PED. TETRA is covered for a minimum distance of 30 cm between T-PED and qualified equipment. For equipment installed at a greater distance to possible T-PED locations the lower limit of 20 V/m is considered sufficient.

It is adequate to confirm the estimated field strength values for the close distance (0.1m) between T-PED and aircraft electronic equipment for a variety of real transmitters, because of the mentioned problems involved in the accurate calculation and extrapolation of the electric field strength in the near field region.

For the same reason it is recommended to investigate dedicated test procedures that consider the near field character and the locally concentrated field strength values of the mobile device, which illuminate the aircraft's electronics from the aircraft's interior. A test set-up based on transmitted power is given in A.3.2, while the principal for the field strength test set-up is explained in A.3.4.

## ANNEX 3

### QUALIFICATION OF AIRCRAFT EQUIPMENT AGAINST INTENTIONAL EMISSIONS OF PEDS

The procedure described here corresponds to a qualification procedure that may be performed when the required safety margin has not been demonstrated in the process depicted in Figure 11, and the aircraft equipment basic qualification tests did not account for exposure from a close distance (i.e. 10 cm) or specific signal modulation.

Moreover, it is recommended that aircraft equipment is qualified in advance using one of the two test procedures given below, using the below referenced waveforms and levels that have been derived in ANNEX 2. If this qualification has been done no further test is needed for that particular equipment, as the analysis will demonstrate the requested safety margin according to the process in Figure 10.

Consequently, if the below given qualification procedures are adequately addressed within the overall aircraft equipment qualification, the aircraft can be considered qualified for the use of T-PED according to ANNEX 2 inside the aircraft.

#### A.3.1 EQUIPMENT QUALIFICATION TEST METHODS

Two potential approaches for the selection of a forward fit equipment qualification test procedure can be defined.

- Transmitted power test procedure
- Electric field test procedure

Both procedures have drawbacks and advantages. They will be discussed in the following sections. Nevertheless, method 1 is mandatory for qualification of aircraft systems against PEDs that are expected to be closer than 0.1m to the equipment to be qualified.

#### A.3.2 TRANSMITTED POWER TEST PROCEDURE

The first method is based on the adjustment of the transmitted power. The EUT is exposed in the near field, in the range of 0.1 m distance in front of the antenna. The test system uses a directional coupler used to adjust the actual transmitted power. The coupler measures the transmitted and reflected power separately. The difference of both signals is a measure for the transmitted power of the antenna that has to be controlled. The Figure 22 depicts the test set-up in form of a block diagram.

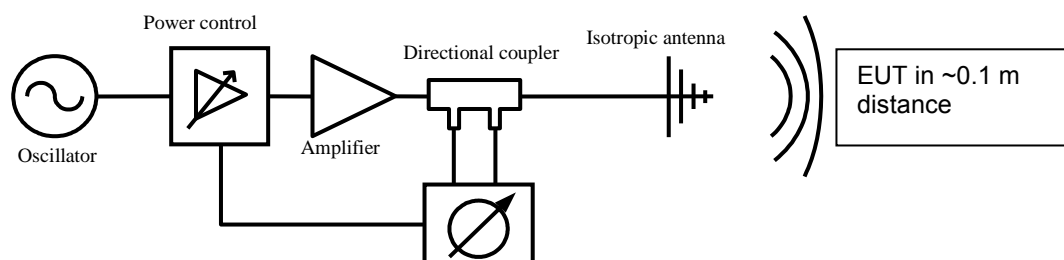

FIGURE 22 : BLOCK DIAGRAM FOR TESTING WITH THE HELP OF THE TRANSMITTED POWER



The set-up operates with a signal generator connected to the input of the power control. The power control is used for adjusting the forward power. ED-14/DO160D section 20 does not include this test procedure. The resulting illumination of the EUT is local and represents the local field strength hot spot of a T-PED close to the EUT.

The radiated signal is a low power signal in the range of 2-8 W. This level is sufficient for generating the required field onto EUT to simulate the field provoked by a T-PED positioned at a 0.1 m distance. The closer the test transmitter is positioned to the EUT, the less significant the influence of multiple devices becomes. Therefore, the test levels for transmitted power testing may be kept on a moderate level, although the potentially high field strength provoked by a real T-PED is adequately simulated.

### A.3.3 TEST SIGNAL LEVELS FOR TRANSMITTED POWER EQUIPMENT TEST

For a transmitted-power-based test the applied levels should simulate the power transmitted by the T-PED at a distance of 0,1m. The studies involving the most representative T-PED standards today performed in the previous annex compile the radiated power levels at this exact distance for GSM, i-DEN, IS-136/TDMA/DAMPS, PDC, PHS UMTS TDD, IEEE 802.11a, IEEE 802.11b g, ZigBee and Bluetooth, in the TDMA technology scheme, and UMTS NAMPS/AMPS, CDMAone and CDMA2000 in the CW-like scheme. The power level masks for these standards is shown in Figure 20, for TDMA, and Figure 21, for CW-like, and are to be applied to the test signal described at the end of A.2.3.1 and A.2.3.2 respectively.

**For Transmitted power testing, TDMA standards:**

<b>Test signal used:</b>	<b>Described at the end of A.2.3.1, Figure 12.</b>
<b>Test levels used:</b>	<b>Figure 20</b>

**For Transmitted power testing, CW-like standards:**

<b>Test signal used:</b>	<b>Described at the end of A.2.3.2, Figure 13.</b>
<b>Test levels used:</b>	<b>Figure 21</b>

### A.3.4 ELECTRIC FIELD TEST PROCEDURE

According to the second test method, the electric field at the EUT location is adjusted. This method is used for HIRF qualification in line with ED-14/DO160 section 20, at a 1m distance in front of the antenna. This set-up generates, compared to the previous method, a more uniform electric field strength at the EUT location, at all test frequencies, and it cannot reflect the local illumination behaviour of a T-PED.

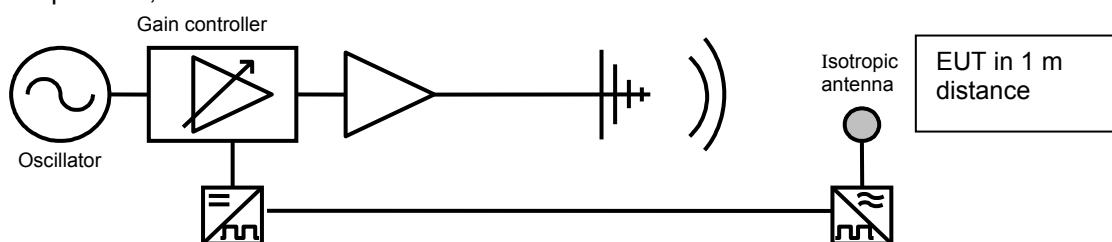

**FIGURE 23 : BLOCK DIAGRAM FOR TEST WITH ELECTRIC FIELD CALIBRATION**

Figure 23 shows the mentioned set-up. The electric field strength is monitored using an (isotropic) antenna at the EUT location. The distance between EUT and the antenna of the test device requires high-radiated power levels and may lead to significant over-testing. This set-up also may cause over testing, because the illumination of the EUT is not local as in the assumed worst-case situation.

### A.3.5 TEST SIGNAL LEVELS FOR ELECTRIC FIELD EQUIPMENT TEST

For an electric-field-based test the applied levels should simulate the radiated field strength by the T-PED at a distance of 1m. The studies involving the most representative T-PED standards today performed in the previous annex compile the radiated electric field levels at this distance for GSM, i-DEN, IS-136/TDMA/DAMPS, PDC, PHS UMTS TDD, IEEE 802.11a, IEEE 802.11b g, ZigBee and Bluetooth, in the pulsed signal technology scheme, and UMTS NAMPS/AMPS, CDMAone and CDMA2000 in the CW-like scheme. The electric field level masks for these standards are shown in Figure 18, for TDMA, and Figure 19, for CW-like, and are to be applied to the test signal described at the end of A.2.3.1 and A.2.3.2 respectively.

#### For Electric field testing, Pulsed signal standards:

**Test signal used:** See A.2.3.1, Figure 12.

**Test levels used:** Figure 18

#### For Electric field testing, CW-like standards:

**Test signal used:** See A.2.3.2, Figure 13.

**Test levels used:** Figure 19

Recommended test levels for equipment qualification, based on the technical discussion in this document (ED 130) are given in A.4.3. Also given in A.4.3 are alternative test levels recommended by RCTA SC-202.

The values according to Figure 12 and Figure 18 and figures Figure 13 and Figure 19 are sufficient to ensure electromagnetic compatibility of LRUs with T-PED.

In contrast to HIRF requirements, a field strength attenuation of the fuselage cannot be considered for reducing test levels, as T-PEDs will be inside the fuselage.

### A.3.6 CONCLUSION

The transmitted power test method covers the local illumination of the EUT by the T-PED. The dominant effect in terms of multiple T-PED use is the one of the closest device, for example, a 2 W GSM phone at a 0.1 m distance results in a 2 to 8 W test signal at the same distance. The test procedure reproduces the worst-case T-PED environment and covers short distances between T-PED and electronic aircraft equipment. It is at present not included in ED-14D/E (DO-160D/E). The following table shows a comparison between required radiated power levels and used calibration procedure according to Figure 18 up to Figure 21 of A.2.6. The frequency bands in the first column depend on the equipment qualification tests. The required radiated power levels for electric-field test procedure with the test antenna 1 m in front of the EUT are higher, by a factor of 100, compared to the transmitted power test procedure. Both methods produce the field strengths in the same order of magnitude, but at completely different power levels.

Test procedure	Required radiated power levels for <b>0.1m distances</b> between test antenna and EUT ( <i>Transmitted power test procedure</i> )	Required radiated power levels for <b>1m distances</b> between test antenna and EUT ( <i>Electric field test procedure</i> )
Frequency bands		
CW-like signals (FDMA)		
0... 850 MHz	4 W	400 W
850... 2000 MHz	2 W	200 W
2000... 6000 MHz	400 mW	40 W
Pulse-modulated signals (TDMA)		
0... 1500 MHz	8 W	800 W
1500... 2000 MHz	4 W	400 W
2000... 5600 MHz	800 mW	80 W
5600... 6000 MHz	4 W	400 W

**Table 13 : Comparison between required radiated power levels and test procedures**

The *electric* field test procedure has a disadvantage due to the required radiated power. To reproduce the environment of a T-PED at short distances (0.1 m) from the electronic equipment, a high power level is needed. The test distance of 1 m between the test antenna and EUT may require a 100 times higher transmitting power level, in order to reproduce the field strength at the location of the EUT, compared to the radiated power levels needed for the transmitted power test procedure. The electric field test is in use according to today's procedures specified by ED-14/DO160D, sec. 20, but it might lead to over testing during equipment qualification.

## ANNEX 4

### IDENTIFICATION OF QUALIFICATION LEVELS CONCERNING BACKDOOR SUSCEPTIBILITY

#### A.4.1 IDENTIFICATION OF THE QUALIFICATION LEVELS

This appendix provides guidance to determine the immunity levels of the aircraft systems in term of field strength. However, a more appropriate term is the qualification levels of the equipment. These qualification levels are the electric field or current levels that the equipment can sustain without adverse affect.

These levels ensure that the aircraft systems operate normally in the electromagnetic environment generated by the aircraft systems (including aircraft transmitters).

For the aircraft where control systems (for example fly by wire) have been introduced, the protection levels ensure that the aircraft systems operate normally when the aircraft encounters a severe electromagnetic environment generated by ground transmitting stations or by radar stations.

The qualification levels are not the same for all the aircraft systems and equipment. Only the most critical systems have been protected to very high levels compatible with severe threats.

The values given in this appendix refer to the various qualification levels of aircraft equipment according to the equipment criticality.

In order to make sure that the DUI will not interfere with equipment of any criticality level (critical, essential-hazardous, essential-major, and non-essential), the lowest field limit should be considered. The other field values corresponding to critical equipment are given for information only.

For an aircraft having equipment that is not already qualified for wireless services inside the cabin, the equipment's qualification levels should be identified for further analysis.

The intent is to provide the possibility of analytically evaluating a protection margin from a safety standpoint as regards control systems to avoid the need for specific functional tests on systems of high immunity.

The value of the maximum allowed electromagnetic field below has to be compared to the field generated by the DUI at the aircraft equipment level and coming from the calculations described in other ANNEXES of this document.

#### A.4.2 GENERAL AIRCRAFT EQUIPMENT IMMUNITY LEVELS

##### A.4.2.1 Aircraft manufacturer's data

The aircraft manufacturer shall provide the equipment qualification levels to the operator. The information provided to the operator shall include:

- The equipment test levels, according to the equipment categories, the equipment location, the equipment criticality,
- The test procedure employed during equipment qualification (waveforms and frequency bands, tests configurations).

#### A.4.2.2 Default levels from HIRF qualification

Since 1987, aircraft RF susceptibility protection and more specifically High Intensity Radiated Field (HIRF) protection has been required by the FAA, CAA and JAA. There are differences between the FAA and JAA HIRF requirements at this time, particularly related to the aircraft systems that must be considered, and the test methods for demonstrating HIRF protection. The FAA HIRF requirements apply to systems with catastrophic failure conditions (FAA notice 8110.71). The FAA allows compliance by subjecting the designated systems to a laboratory test level of 100 V/m for transport aircrafts. The table below gives the immunity levels that can be assumed from the FAA requirements.

Qualification Levels	30 MHz to 400 MHz	400 MHz to 8 GHz	8 GHz to 18 GHz
Critical equipment	100 V/m	100 V/m	100 V/m
Other equipment	1 V/m	1 V/m	1 V/m

**Table 14 : Default qualification levels for fly by wire aircraft**

The JAA HIRF requirements apply to systems with catastrophic, hazardous, and major failure conditions (JAA INT/POL/25/2). The JAA requires that systems with catastrophic failure conditions be tested to the external HIRF environment, reduced by the aircraft shielding.

#### A.4.3 ELECTRIC FIELD TEST LEVELS FOR EQUIPMENT QUALIFICATION

For an electric-field-based test the applied levels should simulate the radiated field strength by the T-PED at a distance of 1m. The studies involving the most representative T-PED standards today performed in ANNEX 2 compile the radiated electric field levels at this exact distance for GSM, i-DEN, IS-136/TDMA/DAMPS, PDC, PHS UMTS TDD, IEEE 802.11a, IEEE 802.11b g, ZigBee and Bluetooth, in the pulsed signal technology scheme, and UMTS NAMPS/AMPS, CDMAone and CDMA2000 in the CW-like scheme.

Based on the assumption that a general protection for required systems and for systems performing safety relevant functions need to be ensured under any circumstances the ED-130 recommends the following protection levels. Accordingly for lightning and HIRF categories A, B and C, a distance of 10cm between PED and device under test has been assumed. For quality reasons a distance of 1m between T-PED and equipment has been assumed for lightning and HIRF categories D and E. This way the 20 V/m protection level is chosen.

RADIATED SUSCEPTIBILITY ENVIRONMENT FOR CABIN, CARGO AND COCKPIT			
EQUIPMENT CATEGORY	Equipment Location	Type of modulation	TEST LEVELS (V/m)
Lightning and HIRF Categories A, B and C	Cabin, Cargo area or area accessible by crew or passengers during flight	CW test levels	300 MHz – 850MHz: 110 V/m 850 MHz - 2 GHz: 80 V/m 2 GHz - 6 GHz: 35 V/m
		Pulse test levels: (Pulse Repetition Frequency of 200 Hz and a duty cycle of 12.5%)	300 MHz – 1.5 GHz: 150 V/m 1.5 GHz - 2 GHz: 110 V/m 2 GHz – 5.6 GHz: 50 V/m 5.6 GHz – 6 GHz: 110 V/m
	Other areas	not applicable	not applicable
Categories D and E	Cabin, Cargo area or area accessible by crew or passengers during flight	CW test levels	300 MHz - 6 GHz: 20 V/m
		Pulse test levels: (Pulse Repetition Frequency of 200 Hz and a duty cycle of 12.5%)	300 MHz - 6 GHz: 20 V/m
	other areas	not applicable	not applicable

**Table 15 : RF Radiated Susceptibility levels in the 300MHz - 6GHz band (Internal Transmitter Environment)**

As an alternative, the following, high, test levels qualify aircraft electronics being tolerant against T-PED's intentional emissions. RTCA SC-202 recommends the levels in Table 16. They are taken from EUROCAE document ED-14E (RTCA DO-160E), section 20. The recommendation by RTCA SC-202 is selected by comparing ED-14 and the information within ANNEX 2 of this document. The values are also an acceptable means for demonstration of T-PED tolerance.

Classification of system	Distance between T-PED and system LRU > 20 cm	Distance between T-PED and system LRU < 20 cm
Catastrophic	ED-14E / DO-160E, Section 20, Cat. R	ED-14E/DO-160E Section 20, Cat. W, limited to 8 GHz
Hazardous	ED-14E / DO-160E, Section 20, Cat. R	ED-14E / DO-160E, Section 20, Cat. R
Major	ED-14E / DO-160E, Section 20, Cat. R	ED-14E / DO-160E, Section 20, Cat. R
Required by regulation but not identified by the failure condition above	ED-14E / DO-160E, Section 20, Cat. R	ED-14E / DO-160E, Section 20, Cat. R

**Table 16 : Alternative qualification levels recommended by RTCA SC-202 for T-PED tolerant aircraft design**

#### A.4.4 EXAMPLES OF SETS OF QUALIFICATION LEVELS

The tables below give two examples of sets of qualification levels, corresponding to different year of qualification.

Qualification Levels	30 MHz to 400 MHz	400 MHz to 8 GHz	8 GHz to 18 GHz
Critical equipment	200 V/m	200 V/m	200 V/m
All other equipment	1 V/m	1 V/m	1 V/m

**Table 17 : Example of qualification levels for Long Range aircraft equipment qualified between 1987 and 1992**

Equipment criticality	Equipment location	100 MHz – 1 GHz	1 GHz – 6 GHz
<b>Critical (Cat. A)</b>	Externally mounted	100 V/m	350 V/m
	Cockpit	50 V/m	200 V/m
	Cockpit (FADEC, FCS)	100 V/m	400 V/m
	Cabin	30 V/m	60 V/m
	Cabin (FADEC, FCS)	60 V/m	120 V/m
	Electronic bay	30 V/m	60 V/m
	Electronic bay (FADEC, FCS)	60 V/m	120 V/m
<b>Essential Hazardous (Cat. B)</b>	Externally mounted	50 V/m	300 V/m
<b>Essential Hazardous (Cat. B)</b>	Cockpit	20 V/m	150 V/m
<b>Essential Hazardous (Cat. B)</b>	Cabin	10 V/m	40 V/m
<b>Essential Hazardous (Cat. B)</b>	Electronic bay	20 V/m	20 V/m
<b>Essential Major (Cat. C)</b>	Any locations	5 V/m	5 V/m
<b>Other equipment</b>	Any locations	1 V/m	1 V/m

**Table 18 : Example of qualifications levels for Long Range aircraft equipment qualified since 1998**

## ANNEX 5

### PREPARING AIRCRAFT TESTING AGAINST THE INTENTIONAL EMISSION OF T-PEDS

The process described in this annex is that one labelled as "Test" in Figure 11. Figure 24 provides a step-by-step representation. This procedure applies for the case in which the safety margin is insufficient, or when re-qualification of the aircraft equipment is not possible and testing is required as explained before.

In the first place, the determination of the EMC environment that will be created by the use of the T-PED technology in question is necessary. This information may be obtained from ANNEX 2 based on the T-PED characterization sub process defined in reference [1], section 3.1.

To account for effects caused by simultaneous use of multiple T-PEDs a multiple equipment factor (MEF) is introduced. This penalty factor increases the emitted field strength level from T-PEDs and therefore it has **not** been taken into account in the resulting test levels provided in ANNEX 2 up to now. It also covers the following aspects:

- Multiple locations
- Superposition effects including effects from multiple reflections inside the cabin and radiation from multiple devices (see MEF)
- Safety margin

Detailed information about the derivation and assessment of the MEF can be found in the following sections and [4].

Also, appropriate locations for the transmitting antenna need to be chosen. These should be representative for locations, where T-PEDs may operate (e.g. cabin, but also cargo compartment), close to victim receiver antennas and areas where an accumulation of electronic avionic equipment may be found (e.g. E-bay).

#### **A.5.1 AIRCRAFT TESTING PREPARATION (MULTIPLE DEVICE RISK ASSESSMENT FOR AIRCRAFT INTERACTION TESTING)**

##### **A.5.1.1 Multiple device risk assessment for aircraft interaction testing**

Several effects are connected to the simultaneous use of multiple transmitting portable electronic devices (T-PEDs), which affect the overall field strength level emitted from T-PED inside the aircraft, i.e.:

- Spurious emissions from T-PED may accumulate (including intermodulation)
- Intentional transmission protocol from T-PED
- The possibility to operate a "fault mode" T-PED increases with respect to the number of T-PEDs on board the aircraft



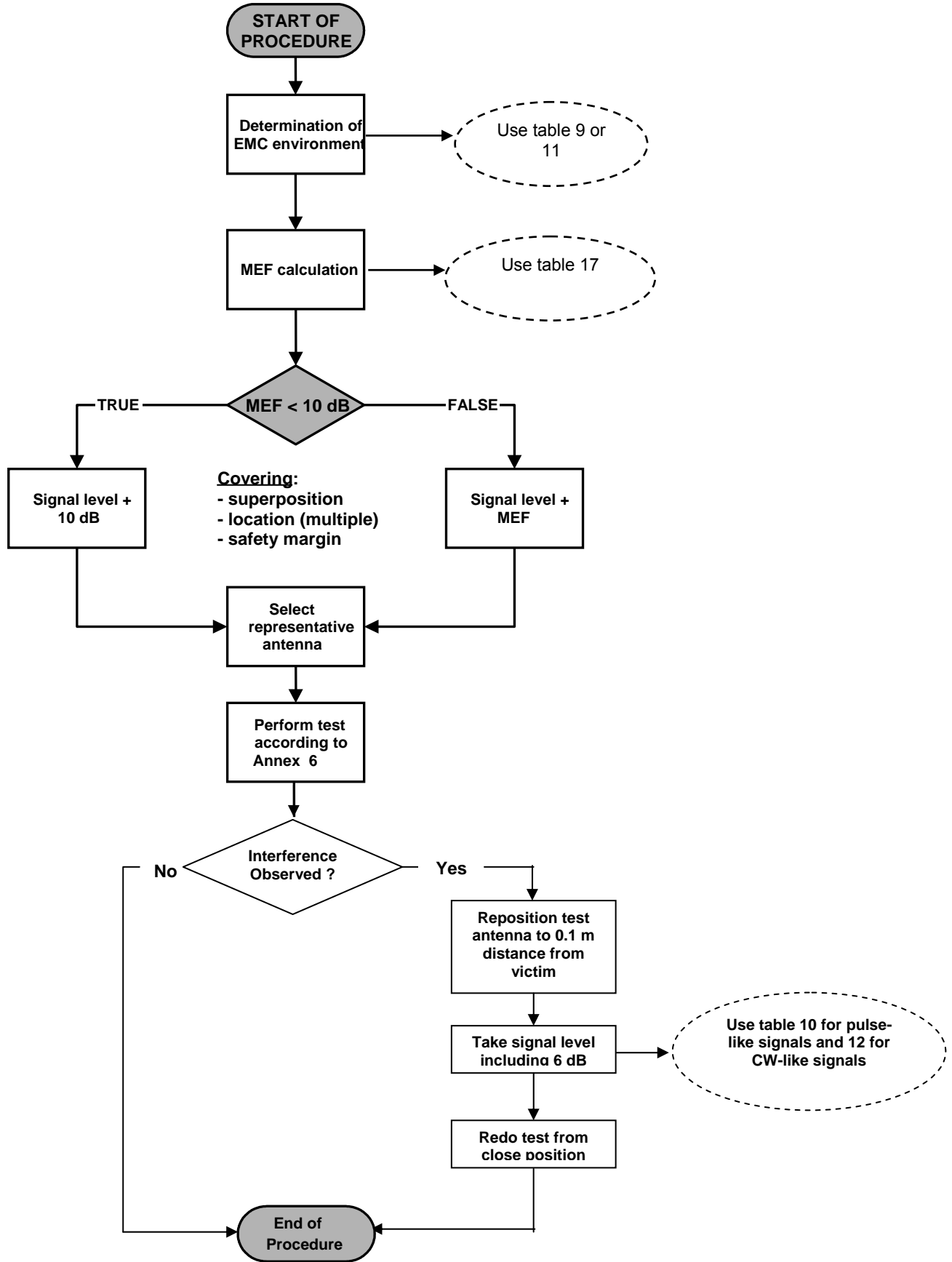

FIGURE 24 : AIRCRAFT TESTING PROCESS

All three effects need to be considered for risk assessment and/or safety demonstration for an approval of non-restricted use of T-PEDs on board a particular aircraft type. Hence, it is recommended to account for all three possible effects with the help of a multiple device factor penalty. The procedure to determine the possible signal amplification is given in [4].

#### **A.5.1.2 Accumulation of spurious emissions**

For spurious emissions from T-PED (also for non-transmitting portable electronic devices) an increase in signal strength is expected for the case of multiple devices of the same model or with the same circuitry inside the PED. The accumulated field strength will be of low level compared to aircraft system qualification thresholds for non-receivers.

There is no need to assess the spurious emissions with respect to back-door coupling. The possibility of interference to aircraft receivers via front door coupling rises with the number of such PEDs used simultaneously. This is handled by operational guidelines (see also Chapter 3, Annex 1 and 8).

#### **A.5.1.3 Accumulation of Intentionally Transmitted Signals from T-PEDs**

T-PEDs usually follow a given, well-controlled transmitter-receiver protocol that limits the simultaneously intentionally transmitted signal for a small number of single T-PEDs operating at the same frequency at the same time.

This number of T-PEDs has to be evaluated based on the number of sources, i.e. number of channels or actual transmitters (see ANNEX 2). It shall be applied to the multiple device factor analysis [1], taking into account limitations that may apply in the vicinity of an aircraft such as restriction on the number of transmitting devices, or other network restrictions that may arise.

Based on the technology under analysis, there are 2 specific cases: For technologies based on the TDMA access scheme, the number of sources used for choosing the MEF is equal to the number of operating channels (i.e. carrier frequencies) in the vicinity of the A/C and not to the number of transmitting devices itself, since one channel can support several devices (up to 8 devices per channel for GSM, for example, but still there is only one signal at one channel). On the other hand, for the CDMA access scheme, the number of sources does correspond to the number of devices inside the A/C, since all communication action is simultaneous. According to this, for a given standard, the number of sources (channels) that corresponds to the frequency band to be analysed is taken. This number is modified if there is any network or aircraft restriction like mentioned before, and the resulting number of sources is then used to select the proper MEF.

For a demonstration of the aircraft's safety by means of testing, it is necessary to use a multiple device factor of at least 10 dB with respect to uncertainties in the test antenna locations inside the aircraft. If the multiple device factor results in values higher than 10 dB, the higher value is to be applied. The minimum amplification factor of 10 dB is necessary due to the following reason:

The interaction test antennas are usually not placed in all locations possible for T-PED. Therefore, the minimum amplification of 10 dB accounts for T-PED locations, which are not directly covered by the test antenna position.

**In the event that the multiple device assessment according to [1] gives higher values than 10 dB, transmission protocol (e.g. TDMA, CDMA...) included, for the T-PED or the system, then the higher values are adequate.**

With such values, fault mode T-PED issues (transmission at maximum power, not regulated) are covered. From [4], with the sources placed concentrically around one source in the origin, the MEF vs. minimal distance  $d$  between sources is calculated (Table 19) and depicted (Figure 25):

$d/(m)/$ # of sources	2	4	8	16	32	64	128	256	512	1024
0,5	3dB	6dB	8dB	10dB	12dB	14dB	15dB	16dB	17dB	18dB
0,75	3dB	6dB	7dB	9dB	11dB	12dB	13dB	14dB	14dB	15dB
1	3dB	5dB	7dB	8dB	10dB	10dB	11dB	12dB	12dB	13dB
1,5	3dB	5dB	6dB	7dB	8dB	9dB	9dB	10dB	10dB	11dB
2	3dB	4dB	5dB	6dB	6dB	7dB	7dB	8dB	8dB	8dB
3	1dB	2dB	3dB	3dB	4dB	4dB	4dB	5dB	5dB	5dB
5	0,5dB	0,5dB	1dB	1dB	2dB	2dB	2dB	2dB	3dB	3dB

**Table 19 : MEF / dB according to number of sources and minimal distance  $d$  between them**

For configurations corresponding to MEF values marked in orange, the resulting MEF factor shall be replaced by a 10 dB value in order to account for every possible location of the PEDs. For the rest (marked in yellow), the calculated values in Table 19 are appropriate.

The MEF values in Table 19 are to be used for the process in Figure 24, when there is a roughly estimated a 1 meter distance between the T-PED and the equipment. For the initial aircraft testing, the safety margin should always be taken as the maximum value of 10 dB and the MEF factor,  $SM=MAX(10db, MEF)$ . The testing process also provides for near field illumination of a potential victim device in the aircraft. The estimated distance for this near field illumination is 0.1 meter. If the distance is 0.1 meter then the MEF values are small since the local T-PED is totally dominating the field level. For the close distance investigation according to Figure 24, i.e. the 0.1m cases, a 6 dB margin is adequate.

Also, taking into account the importance of basing the tests on power testing and not on E-field testing as stated before, the testing power levels including MEF effects can be affected by pico-cells onboard the A/C, which have a mitigating action by allowing low power levels inside the A/C (GSM for example), and by functional hazard tests. These factors determine that the lower basis power levels from the different standards are adequate for the calculation of the test power levels shown.

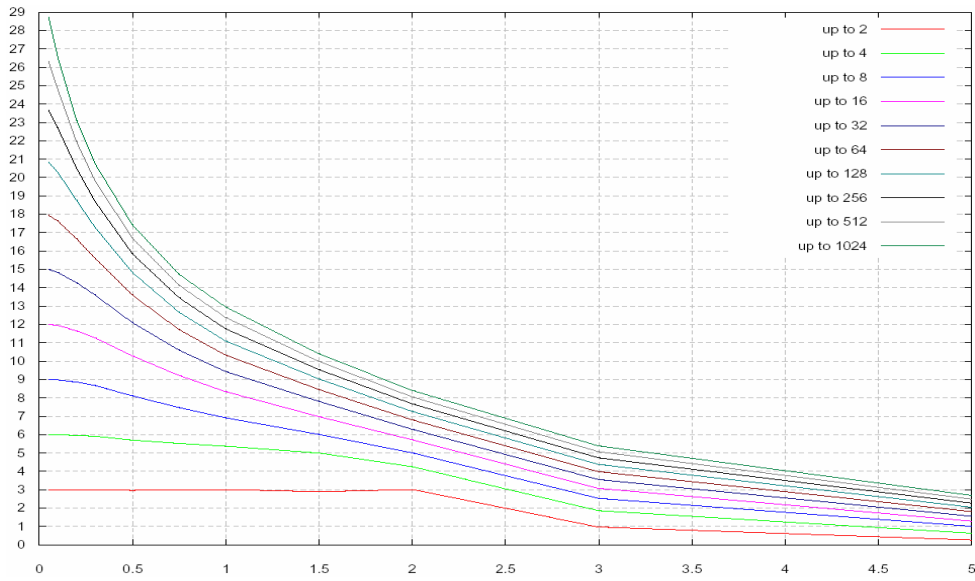

**FIGURE 25 : MEF (DB) VS. MINIMAL DISTANCE BETWEEN SOURCES (M)**

**NOTE:** *The use of actual T-PED devices instead of dedicated test-signal generators is not adequate, due to poor test reproducibility and possibly not representative T-PED location inside the aircraft. In addition, the safety margin cannot be demonstrated.*

## ANNEX 6

### PROCEDURE FOR FUNCTIONAL AIRCRAFT TESTING

#### A.6.1 INTRODUCTION

The previous considerations regarding the presence of numerous T-PEDs are to be taken into account before aircraft testing. They represent necessary steps before testing starts. The subsequent paragraphs are to be considered for the actual testing procedure.

This section does not constitute a “test procedure” as such. This is specific to the aircraft model(s), aircraft equipment and configuration, and the criticality/operation of the aircraft functions. Instead, its purpose is to provide clear guidelines for establishing this procedure that should demonstrate if the aircraft’s systems are not susceptible to interference from a particular wireless technology operated within the airframe. The results of the tests may be applied to other aircrafts if sufficient similarity can be established (i.e. similar design and outfitting). The airline or the operator is solely responsible for this demonstration.

Additionally, the guidance describe in this section is intended for supporting operational allowance, not certification approval. Also, the transmission of test signals in the authorized T-PEDs bands requires coordination with the corresponding telecommunications regulatory authority and the spectrum owners.

##### A.6.1.1 Purpose of test

The following Electromagnetic Interference Test is to be performed in order to demonstrate that the onboard use of T-PEDs operating under the standards mentioned in Appendix 2 causes no disturbances on any electronic equipment installed on the aircraft.

##### A.6.1.2 Airworthiness requirements

CS 25.1353(a): *Electric* Equipment and Installation

CS 25.1431(c): Electronic Equipment

CS 25.1309

#### A.6.2 AIRCRAFT CONDITION BEFORE TEST

##### A.6.2.1 Power Supply

Any power supply appropriate to run the aircraft’s electronic systems can be used. Additionally, a special ground power supply has to be provided to connect test equipment.

##### A.6.2.2 Aircraft Environment

The tests shall be undertaken with the aircraft on the ground. Ideally, the distance between the A/C and any obstacle (e.g. buildings, metallic structures and/or other A/Cs) shall be at least 200 meters. All passenger and cargo doors and hatches must be closed. Gangway access to the aircraft shall be established. The antenna gains, test equipment manufacturers, part numbers, and other pertinent test equipment information shall be recorded.

Aircraft test condition has to be set-up and documented by the ground test engineer.

### A.6.2.3 Regulatory aspects

Coordination with the relevant national telecommunications regulatory body and spectrum owners will be required. This should be done well in advance, as the process leading to authorization can be lengthy. Essential parameters include location of test, date of test, transmit power levels and desired frequency ranges.

### A.6.2.4 Other tests to be performed previous to functional aircraft testing

The test programme, described here, shall be performed after all cabin and NAV/COM Systems, Emergency Locator Transmitter (ELT), autopilot system, hydraulic power and all flight computers are installed and their functional tests have been successfully completed. Also, existing in-flight entertainment system and other non-essential equipment (ambient lights, etc) shall be operational.

For nav./com. Systems, the purpose of these procedures is to identify possible interferences.

It would be a functional test with the device under investigation switched on and used at its worst-case configuration regarding to field emissions. The aircraft receivers are run simulating an operational configuration, with the help of a ground transmitter in order to simulate ground navigation station.

The following aircraft receivers are examples considered for previous testing:

- ADF
- HF
- VHF
- VOR / MKR
- ILS Loc and G/S
- DME
- ATC Mode S / T.CAS
- SAT/COM
- GPS
- Radio Altimeter

The test conditions discussed before are also applicable.

### A.6.2.5 Status of Systems

During the tests, any aircraft electronic systems shall be operational as listed in Table 20, for example. Additional systems required for flight conduction shall be operational as well.

Aircraft System	Condition during test on Ground	Remark
Engines	Off	HIRF qualification is conducted
Generators	Off	HIRF qualification is conducted
APU	Off	HIRF qualification is conducted
FADECs	On	HIRF qualification is conducted
All Computers	On	
Hydraulic Pumps	Off	Shall be switched off, to protect pumps from overheating
GPU	On / EXT A	
VOR 1 / VOR 2	Ramp Tester Frequency	Ramp tester, adjust and note lowest operational Level, Indicate noise related to wireless service
ADF 1 / ADF 2	On	Indicate deviation in direction
ILS	Ramp Tester Frequency	Ramp tester, adjust and note lowest operational Level Indicate deviations from glide slope and Localizer

<b>DME</b>	Ramp Tester Frequency	Ramp Tester, adjust and note lowest operational Level
<b>VHF 1</b>	On	Adjust Lower Frequency
<b>VHF 2</b>	On	Adjust Middle Frequency
<b>VHF 3</b>	On	Adjust Upper Frequency
<b>GPS 1</b>	On	Indicate Position of Aircraft
<b>GPS 2</b>	On	Indicate Position of Aircraft
<b>In Flight Entertainment</b>	On	Monitor Displays
<b>CIDS</b>	On	Monitor Warnings on System Panels
<b>Cabin Lights</b>	On	
<b>CDLS</b>	On (if installed)	
<b>Air Conditioning</b>	On	
...	...	Additional systems, if found necessary

**Table 20 : Aircraft systems condition for interaction test**

Record the aircraft system (major component) part numbers and manufacturer information for all aircraft systems being evaluated. The purpose of this is to establish the aircraft at the time of test and the results of this test which may be applicable for similar considerations for follow-on installations on other aircrafts. For this application, major components are defined as the major data processing and data displaying components, such as those found in the flight deck, equipment bays and equipment racks. Relays, switches, or other similar devices that typically are not affected by electromagnetic fields from the established aviation environment are not necessary to be recorded.

Aircraft test condition has to be set-up and documented by the ground test engineer.

#### **A.6.2.6 Safety Instructions**

For the operation of test equipment on-board the A/C the appropriate safety instructions shall be obeyed. During the test electromagnetic fields will be generated inside the cabin at an increased power level. For safety reasons the amplification shall be limited to legally permitted power density levels, to ensure the safety of the testing staff, visitors and observers and a minimum safety distance for personnel shall also be established. This distance, along with the power density limits are given by the country's health standard, for example in Germany by [3]. Also take into account European and international standards. Some essential limits for testing are listed in the following Table 21. In order to keep to the limits at a distance of approximately 0.5 m from the emitter, an absolute limit on the Effective Isotropic Radiated Power (EIRP) is to be maintained. This has to be considered for the selection of the amplification level required to perform the test.

**NOTE:** for testing a transmitter license may be required.

Interference to other services must be avoided.

Frequency range	Limit for General Public Exposition (W/m <sup>2</sup> )	EIRP /dBm (d = 0.5 m) distance	Limit for Occupational Exposition (W/m <sup>2</sup> )	EIRP (dBm) (d = 0.5m)	Remarks
400 MHz – 2000 MHz	f / 200 MHz	38...45	f / 40 MHz	45...52	Duration ≥ 6 minutes
2000 MHz – 300 GHz	10	45	50	52	Duration ≥ 6 minutes

**Table 21 : Limits for Human exposition to electromagnetic fields, according to [4]**

### A.6.3 TEST DESCRIPTION INCLUDING TEST EQUIPMENT

#### A.6.3.1 Test equipment

The EMI test staff shall provide the following equipment:

- Signal generator (signals according to Appendix 2)
- Power amplifier
- Power splitter
- Test receiver (to check applied power)
- Test antenna (monocone, bicone)
- Antenna support
- E-Field meter
- Cables (Remark: include cable attenuation in transmitter power level)

#### A.6.3.2 Test requirements/description

##### 1. Test signal definition

The test shall be performed to verify that the possible electromagnetic threat caused by a wireless system is less than the susceptibility threshold of the aircraft electronic systems. To achieve this, the test shall be performed with the signal generator producing representative wireless test signals within the cabin which specified in detail ANNEX 2, more specifically in A.2.5, Figure 14 (TDMA) and Figure 15 (CW-like) for electric field test, and Figure 16 (TDMA) and Figure 17 (CW-like) for transmitted power test, along with their derivation, depending on the standard to be evaluated. These shall be amplified according to the accumulation of signals from numerous T-PEDs (i.e. Multiple Equipment Factor, MEF), according to the technology (TDMA, WiFi or CDMA or similar) and the number of sources, from Table 19.

Before application of the levels for *full aircraft testing*, it is mandatory to evaluate the multiple equipment effect of a given number of T-PED used inside the aircraft. This can be done by means of the Multiple Equipment Factor (MEF) evaluation (see A.5.1). The standard's power levels build the basis for the test level. The values are given in table 9 (check for EIRP) for pulse-like waves and in table 11 for CW-like signals. For aircraft testing this power levels have to be amplified by the maximum of 10 dB and the MEF.

If during testing an occurrence is observed, a test from closer distance shall be conducted. For this part of the procedure the power levels in table 10 for pulse like signals and table 12 for CW-like signals have to be taken. They both include already the applicable margin of 6 dB for the close distance testing according to flow chart in Figure 24 (see Annex 5). The MEF value should only be added when there is 1-meter distance between the source and equipment, for 0.1-meter distance the MEF value is always less than 6 dB (see A.5.1).



## 2. Test level and waveform determination

General calculation:

T-PED transmitting frequency emission level:

Transmitted power test:

Use Figure 16 (TDMA) or

Figure 17 (CW-like)<sup>2</sup>

Minus 6 dB safety margin (Use A.5.1.3)

Plus the maximum value of 10dB and MEF when the distance is 1 meter or higher, or

else plus 6 dB when the distance is 0.1 meter (Use A.5.1.3)

Result: Test level for A/C testing

Waveform determination:

Detailed analysis is provided in ANNEX 2. Two basic waveforms are used to represent the T-PED threat.

- Pulsed-, Amplitude Modulated Waveform: Described in detail in A.2.3.1, Figure 12 and it covers all standards mentioned in Table 9.
- Continuous Wave (CW) Waveform: Described in detail in ANNEX 2, section A.2.3.2, Figure 13, and it covers all standards mentioned in Table 11.

## 3. Determination of the electromagnetic threat

The systems shall be monitored with the help of competent observers in the cockpit and in the cabin, and may include a flight engineer, a pilot, a person from the maintenance staff or a person familiar with the A/C technology. Before testing, the electronic systems of the aircraft (see A.6.2) have to be switched on. During the test, the observers have the task to assess the influence from the predetermined “worst-case” test signal on the system area under observation, while testing positions and the associated antenna. The test results for all systems shall be documented during test according to the criteria listed in Table 22, designed to assess the aircraft's systems' behaviour and also taking into account the systems criticality (refer to [5]):

Criterion	A	B	C	D	E	F
Meaning	No effect	Other	Minor	Annoying	Obscuring Function	Loss of Function
Consequent Action	None	Determine Threshold	Determine Threshold	Determine Threshold	Determine Threshold	Determine Threshold
Remark	-	Describe effect	Describe effect	Describe effect	Describe effect	-

**Table 22 : List of criteria to classify possible effect on aircraft systems**

Due to the amplification, the electromagnetic threat is linked closely to the power level emitted from the test set-up. This level shall be monitored and documented during test. If any malfunction of any aircraft system is observed during test, the malfunction is to be described. It's also important to verify whether or not the set-up was the source of interference. Disturbance threshold and antenna position shall be documented thoroughly. Afterwards and in case that interference is suspected, the affected system should be tested at a close distance (~0.1m). The signal level for this close up test should be **without MEF, but instead using the nominal value plus a safety margin of 6 dB**, as for the case of aircraft equipment qualification. The reason for this is that, by performing a close distance test it is being assumed that one T-PED is close to the equipment under test, therefore the MEF has no effect because practically all illumination is coming from one single T-PED, the T-PED close to the equipment.

<sup>2</sup> Levels based upon industry standards

In case of suspected interference perform a close distance test:

**Take the levels in table 10 for pulse like signals or table 12 for CW-like signals both already include the margin of 6 dB**

**Result: Test signal for close distance test in case of suspected interference.**

For the disturbance threshold determination, the following procedure is to be applied:

- Adjust lowest frequency of test signal according to ANNEX 2.
- Switch on signal generator power on a 10dB decreased level in terms of the maximum test level (see test signal definition) to avoid overshooting in the switching process.
- Increase signal generator until maximum test-level is reached. If disturbance occurs, decrease test level by 1dB steps until disturbance disappears.
- Repeat following set-up until maximum test frequency is reached: Increase test-frequency according to the 1% rule. If disturbance occurs decrease test level until disturbance disappears.

The test can then be split into three parts:

- a. Apply artificially amplified signals to at least 5 different locations representing the worst-case potential of interference caused by direct antenna illumination. Monitor electronic equipment indicators in the cockpit. Note disturbed equipment and error occurred, if detected.
- b. Apply artificially amplified signals to at least 7 different passenger seat locations. Monitor electronic equipment indicators in the cockpit. Note disturbed equipment and error occurred, if detected.
- c. Apply artificially amplified signals to at least one defined position in the cockpit and three in the E-bay. Monitor electronic equipment indicators in the cockpit. Note disturbed equipment and error occurred, if detected.

For each test position the systems in cockpit and cabin shall be monitored for at least 10 seconds, preferably up to 30 seconds to ensure sufficient observation and EUT reaction time. Results and possible interferences with their disturbance thresholds have to be written down in the test report sheet (see iv. Test report, in this section).

#### **4. Test set-up**

Several different positions for the testing antenna inside the aircraft have to be investigated from the electronic bay to the cockpit and different passenger positions. The number and locations of the test positions will depend on the aircraft type under test. Each location will account for multiple T-PED positions and is considered worst-case and including typical/potential areas of mobile transmitter use. Aircraft systems behavior shall be investigated, while stressing the aircraft systems at an artificially increased power level. The frequency sweep will be done using a 1% rule, starting at 500 MHz with 5 MHz steps.

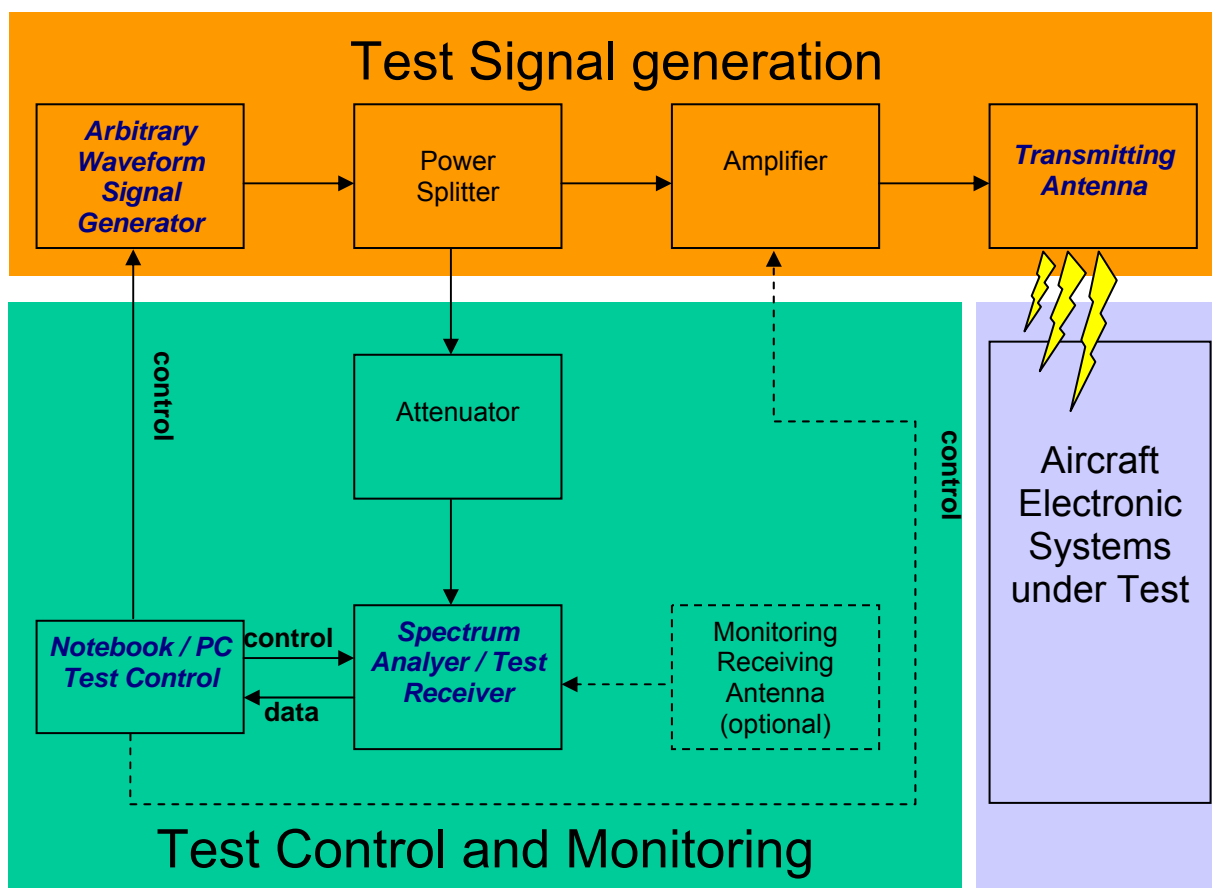

**FIGURE 26 : TEST SET-UP FOR AIRCRAFT INTERACTION TEST**

Future additional services may be examined following the same methodology proposed in ANNEX 2. The amplification has been chosen, to take into account cumulative effects and “worst-case” conditions due to several wireless sources inside the cabin. The amplification level is derived by a dedicated assessment, which investigates the maximum field strength and maximum transmitted power.

##### **5. Test antenna positions inside the aircraft**

For the test, several testing antenna positions are to be investigated. Preferred positions are:

###### **a. Flight deck (~1m from centre instruments and 1 m above floor)**

Exercise the following systems (for example) following the aircraft maintenance manual’s operational test procedures:

- Cockpit Displays
- Cockpit Lighting
- Emergency Lighting
- Fuel Quantity System

###### **b. Electronic bay (~1m above floor tracks, in the centre)**

Since the area of the main equipment is considered large, three antenna positions shall be used. Antenna position is one meter from the centre of equipment bays. At this position, equipment will be monitored following the aircraft maintenance manual’s operational test procedures.

The field values can be attenuated from cabin or cargo bay to the E-bay. If this attenuation factor or transfer function, is known, the test levels can be reduced accordingly. This attenuation factor can be of the order of 10 dB. This value is aircraft and layout dependent. It can be determined by measuring the transfer function from the closest possible area where the T-PED is located to the E-bay. An estimation can be to take the free space calculation as a transfer function.

- c. **Aircraft wireless systems position and antenna.**
- d. **Typical passenger positions (~1.10m above cabin floor).**
- e. **Window areas.**
- f. **Door areas.**
- g. **Crew rest compartment.**
- h. **Other:** required by the operator, such as the locations where the access points will be installed, HIRF qualified aircraft systems, or non-essential non-required systems.



**FIGURE 27 - ANTENNA SET-UPS FOR CABIN AND COCKPIT TESTS**

**Additional remarks on test antenna:**

Ideally, the antenna types to be used are mono-cone or bi-cone antennas because of their broadband characteristics exhibited over the required frequency range. Dipole-type antennas are not recommended because of their narrowband characteristics. Additionally, low or no directivity is important to approximate an isotropic radiator scenario.

At each position, the test shall be documented: seat, frame, window and door positions by indication within a principle diagram of the aircraft cabin.

**6. Personal Test Support**

A ground test engineer, a pilot or a comparable professional support engineer is needed to power on/off and control the aircraft systems over the whole test duration since set-up.

**A.6.3.3 Test close up**

1. De-energize A/C electrical systems.
2. Remove test equipment
3. Perform A/C ground check to verify that no system has been affected by testing.

**A.6.3.4 Test report**

The results of the test shall be summarized in the test protocol, e.g.:

Aircraft System	Condition during test on ground	Remarks (Observed disturbances, threshold level)	Tests Passed
...	...	...	...

**Table 23 : Test protocol – Summary**

## ANNEX 7

### AIRCRAFT TESTING APPLICATION EXAMPLE

The following section provides an example for the process for backdoor immunity qualification as shown in Figure 11. As proposed, for an aircraft to be tested, the steps depicted in this figure will be followed for a particular aircraft system to be tested to reach qualification against Bluetooth, GSM and CDMA2000 emissions.

It is assumed for this case that an aircraft from the Long Range family needs to be tested (300-400 seats).

#### 1. Identification of aircraft systems of interest

For the selected aircraft, between the equipment that can be of interest, the systems located in the cockpit and cabin (FADEC, FCS) were taken for this example. Their failure condition classification is considered as catastrophic, their criticality is defined as "Critical" having a DAL (Development Assurance Level) of A (see [5]).

#### 2. Identification of the known systems RF immunity levels

For the cabin and cockpit FADEC and FCS qualification levels, a reference to A.4.4 can be made. Here, in Table 18, examples of qualification levels for Long Range aircraft equipment qualified since 1998 are available. For the chosen systems, the following information is up to date:

Equipment	100 MHz – 1 GHz	1 GHz – 6 GHz
Cabin (FADEC, FCS)	60 V/m	120 V/m
Cockpit (FADEC, FCS)	100 V/m	400 V/m

Table 24 : Qualification levels for the selected systems FADEC, FCS

#### 3. Analysis of T-PED Characteristics vs. Aircraft immunity systems

From ANNEX 2, a characterization of the EM environment generated by Bluetooth, GSM and CDMA2000 is already provided. From Table 9, the field strengths for Pulse Modulated standards (GSM and Bluetooth) can be taken, as well as those for CW-like standards from Table 11, for a distance of 0,1m to equipment under assessment. By comparing this information based on the frequency ranges proposed in Table 24, the field strength of the different standards, taking the maximum values for the two proposed frequency ranges are:

Standard	100 MHz – 1 GHz	1 GHz – 6 GHz
Bluetooth	-	17,3 V/m
GSM	77 V/m (GSM)	55 V/m (DCS1800, PCS1900)
CDMA2000	55 V/m	55 V/m

Table 25 : Emission levels for Bluetooth, GSM and CDMA2000

#### 4. Is A/C T-PED qualified?

With the previous information the analysis proposed in 4.2.2 can be performed where the calculation of the safety margin will be used to determine if the A/C is T-PED qualified, if an aircraft test is required, if measures ensuring EMC are to be taken and can be taken or if they are not EM compatible.

As explained in 4.2.2, the safety margin is defined as the ratio between the qualification levels of the equipment to be qualified to the emission levels of the T-PED technology under investigation. As said before, examples and guidelines for the qualification levels can be found in ANNEX 4, and emission levels for the most commonly used standards in ANNEX 2, Table 9 and Table 11. The safety margin, using field strength levels, is then defined as:

$$SM \equiv 20 \log \left( \frac{Q.Levels}{E.Levels} \right)$$

For the case in which emitted power levels (EIRP) are used for calculating the safety margin, the factor 20 shall be replaced by a factor of 10. Applying this equation to the values discussed in Table 24 and Table 25 yields the following results for the three chosen T-PED technologies:

AIRCRAFT SYSTEM	Bluetooth		GSM		CDMA2000	
	100MHz - 1GHz	1GHz - 6GHz	100MHz - 1GHz	1GHz - 6GHz	100MHz - 1GHz	1GHz - 6GHz
Cabin (FADEC, FCS)	-	17dB	-2,2dB	7dB	1dB	7dB
Cockpit (FADEC, FCS)	-	27dB	2,3dB	17dB	5,2dB	17dB

**Table 26 : Resulting Safety Margin for the chosen standards**

From the previous table and the method proposed for the analysis of the safety margin, it turns out that the Bluetooth devices are qualified for the whole frequency spectrum since the safety margin is certainly higher than 6 dB. Also, for the frequency range between 1 GHz and 6 GHz, for GSM and CDMA2000 the safety margin shows they are qualified, at least for these frequency ranges. For the rest of the cases the safety margin is insufficient, which means that it is less than 6 dB.

#### 5. Insufficient Safety Margin

When this is the case, measures ensuring EMC can be equipment re-qualification, for example:

For this, the equipment qualification set-ups and procedure from ANNEX 3, must be used to perform a new qualification procedure, if this is the case. If there are options for this, they are implemented. With the new qualification levels, safety margin is revised and if it improves, then T-PED technology under question may be used onboard.

If, on the contrary, the safety margin is less than 6 dB, an aircraft test is in order. Following the process described in Figure 24 0, the starting point is the determination of the EMC environment. Since this test is to qualify GSM and CDMA2000 technologies in this case, then Pulse Modulated and CW-like test signals have to be used. The standard's EIRP levels for this test are the ones shown in 0, tables 9 and 11 respectively. For the aircraft testing process either an amplification of 10dB or the MEF according to table 17 in ANNEX 5 have to be chosen, depending on which value is higher.

For the second step of interference investigation the values out of figures 15 and 16 according may be taken directly. They already include a 6 dB margin.

The aircraft taken into consideration belongs to the Long Range family meaning it has between 300 and 400 seats, with an assumed distance between seats of around 0,5m.

For CW-like standards (CDMA2000), and as explained in ANNEX 5, the number of sources equals the number of seats, so in this case there would be 300-400 sources. For Pulse Modulated technologies (GSM), the number of sources equals the number of operating channels, in this case 9, 32, 94 or 75, depending on the band of operation and assuming a 25% channel usage in the vicinity of an aircraft. This results in 32 channels for GSM and 94 for PCS1900 and DCS1800. Taking the worst-case scenario, these are selected as the number of sources for MEF determination. In the hypothetical case that aircraft testing had to be done to qualify Bluetooth technology, the number of sources would be equal to the number of access points (an assumption of 4 access points is made here), which doesn't account for peer-to-peer connections, so the number of sources would be 4. According to this, for these three technologies the following data is taken:

	Bluetooth	GSM		CDMA2000
		GSM	PCS1900, DCS1800	
# of sources	4	32	94	300 – 400
Approx. # of sources	4	32	128	512
Dist. between sources (m)	0,75	2	1	0,5
Resulting MEF (dB)	6	6	11	17
<b>Selected MEF for test (dB)</b>	<b>10</b>	<b>10</b>	<b>11</b>	<b>17</b>

**Table 27 : Selection of MEF for aircraft testing**

In Table 27, the number of sources is taken as the next highest value according to the number of sources for which the MEF is calculated in Table 19, ANNEX 5. The distances between sources can be assumed. Here, they were taken as a common-sense estimation taking into account the number of sources and actual number of seats inside the cabin: For example, for a 400 seat aircraft with only 4 Bluetooth Access Points, it is most likely that all sources are rather separated than really close, as in Bluetooth for instance. The appropriate value would be the seat distance; in the example here 0,75m have been assumed.

As specified in ANNEX 5, when the MEF is less than 10dB, then 10dB amplification is to be taken and added to the mobile standard's EIRP level, and if it's higher, then the actual MEF value is taken. This gives the aircraft qualification test signal.

The test should be performed based on the guidelines provided in ANNEX 6, having as a result the approval of the technology or the necessity to look for measures that ensure EMC. In the case that no interference is observed during the test then this kind of T-PED may be used on board that particular aircraft. If interferences were observed, a mitigation process has to be initiated. First it has to be checked, if appropriate measures are still available to increase the EMC between aircraft and T-PED.

The outcome of this process may be, either that the use of such T-PED technology is either allowed or prohibited on board an aircraft. If measures are available, they should be implemented and the safety margin should be re-evaluated. A successful improvement should be verified by another aircraft test. If the safety margin was not improved, the process should be repeated.



## ANNEX 8

### PROPOSED FAR REVISIONS TO INCORPORATE PED USAGE SIGNAGE

#### A.8.1 § 25.791 PASSENGER INFORMATION SIGNS AND PLACARDS

- (a) If smoking is to be prohibited there must be at least one placard so stating that is legible to each person seated in the cabin. If smoking is to be allowed, and if the crew compartment is separated from the passenger compartment, there must be at least one sign notifying when smoking is prohibited. Signs which notify when smoking is prohibited must be operable by a member of the flight crew and, when illuminated, must be legible under all probable conditions of cabin illumination to each person seated in the cabin.
- (b) Signs that notify when seat belts should be fastened and that are installed to comply with the operating rules of this chapter must be operable by a member of the flight crew and, when illuminated, must be legible under all probable conditions of cabin illumination to each person seated in the cabin.
- (c) A placard must be located on or adjacent to the door of each receptacle used for the disposal of flammable waste materials to indicate that use of the receptacle for disposal of cigarettes, etc., is prohibited.
- (d) Lavatories must have "No Smoking" or "No Smoking in Lavatory" placards conspicuously located on or adjacent to each side of the entry door.
- (e) If Portable Electronic Device (PED) usage is to be prohibited there must be at least one placard so stating that is legible to each person seated in the cabin. If PED usage is to be allowed, there must be at least one sign notifying when PED usage is prohibited. Signs which notify when PED usage is prohibited must be operable by a member of the flight deck crew and, when illuminated, must be legible under all probable conditions of cabin illumination to each person seated in the cabin.
- (f) Lavatories must have "No PED Usage" or "No PED Usage in Lavatory" placards conspicuously located on or adjacent to each side of the entry door.
- (g) Symbols that clearly express the intent of the sign or placard may be used in lieu of letters.

[Amdt. 25-72, 55 FR 29780, July 20, 1990]

#### A.8.2 § 91.517 PASSENGER INFORMATION

- (a) Except as provided in paragraph (c) of this section, no person may operate an aircraft carrying passengers unless it is equipped with signs that are visible to passengers and flight attendants to notify them when smoking is prohibited and when safety belts must be fastened. The signs must be so constructed that the crew can turn them on and off. They must be turned on during aircraft movement on the surface, for each takeoff, for each landing, and when otherwise considered to be necessary by the pilot in command.
- (b) Except as provided in paragraph (c) of this section, no person may operate an aircraft carrying passengers unless it is equipped with signs that are visible to passengers and flight attendants to notify them when Portable Electronic Device (PED) usage is prohibited. The signs must be so constructed that the crew can turn them on and off. They must be turned on for each takeoff, for each landing, and when otherwise considered to be necessary by the pilot in command.

- (c) The pilot in command of an aircraft that is not required, in accordance with applicable aircraft and equipment requirements of this chapter, to be equipped as provided in paragraphs (a) and (b) of this section shall ensure that the passengers are notified orally each time that it is necessary to fasten their safety belts, when smoking is prohibited, and when PED usage is prohibited.
- (d) If passenger information signs are installed, no passenger or crewmember may smoke while any "no smoking" sign is lighted nor may any passenger or crewmember smoke in any lavatory.
- (e) Each passenger required by § 91.107(a)(3) to occupy a seat or berth shall fasten his or her safety belt about him or her and keep it fastened while any "fasten seat belt" sign is lighted.
- (f) If passenger information signs are installed, no passenger or crewmember may use PEDs while any "no PED usage" sign is lighted.
- (g) Each passenger shall comply with instructions given him or her by crewmembers regarding compliance with paragraphs (c), (d), (e) and (f) of this section.

[Amdt. 91-231, 57 FR 42672, Sept. 15, 1992]

### A.8.3

#### § 91.1035 PASSENGER AWARENESS

- (a) Prior to each takeoff, the pilot in command of an aircraft carrying passengers on a program flight must ensure that all passengers have been orally briefed on--
  - (1) Smoking: Each passenger must be briefed on when, where, and under what conditions smoking is prohibited. This briefing must include a statement, as appropriate, that the regulations require passenger compliance with lighted passenger information signs and no smoking placards, prohibit smoking in lavatories, and require compliance with crewmember instructions with regard to these items;
  - (2) Use of safety belts, shoulder harnesses, and child restraint systems: Each passenger must be briefed on when, where and under what conditions it is necessary to have his or her safety belt and, if installed, his or her shoulder harness fastened about him or her, and if a child is being transported, the appropriate use of child restraint systems, if available. This briefing must include a statement, as appropriate, that the regulations require passenger compliance with the lighted passenger information sign and/or crewmember instructions with regard to these items;
  - (3) The placement of seat backs in an upright position before takeoff and landing;
  - (4) Location and means for opening the passenger entry door and emergency exits;
  - (5) Location of survival equipment;
  - (6) Ditching procedures and the use of flotation equipment required under § 91.509 for a flight over water;
  - (7) The normal and emergency use of oxygen installed in the aircraft; and
  - (8) Location and operation of fire extinguishers; and
  - (9) Portable Electronic Device (PED) usage: Each passenger must be briefed on when, where, and under what conditions PED usage is prohibited. This briefing must include a statement, as appropriate, that the regulations require passenger compliance with no PED usage signage and placards, prohibit PED usage in lavatories, and require compliance with crewmember instructions with regard to these items.

- (b) Prior to each takeoff, the pilot in command of an aircraft carrying passengers on a program flight must ensure that each person who may need the assistance of another person to move expeditiously to an exit if an emergency occurs and that person's attendant, if any, has received a briefing as to the procedures to be followed if an evacuation occurs. This paragraph does not apply to a person who has been given a briefing before a previous leg of that flight in the same aircraft.
- (c) Prior to each takeoff, the pilot in command must advise the passengers of the name of the entity in operational control of the flight.
- (d) The oral briefings required by paragraphs (a), (b), and (c) of this section must be given by the pilot in command or another crewmember.
- (e) The oral briefing required by paragraph (a) of this section may be delivered by means of an approved recording playback device that is audible to each passenger under normal noise levels.
- (f) The oral briefing required by paragraph (a) of this section must be supplemented by printed cards that must be carried in the aircraft in locations convenient for the use of each passenger. The cards must--
  - (1) Be appropriate for the aircraft on which they are to be used;
  - (2) Contain a diagram of, and method of operating, the emergency exits; and
  - (3) Contain other instructions necessary for the use of emergency equipment on board the aircraft.

[Amdt. 91-280, 68 FR 54519, September 17, 2003, effective November 17, 2003]

#### A.8.4

#### **§ 121.317 PASSENGER INFORMATION REQUIREMENTS, SMOKING PROHIBITIONS, AND ADDITIONAL SEAT BELT REQUIREMENTS**

- (a) Except as provided in paragraph (l) of this section, no person may operate an aircraft unless it is equipped with passenger information signs that meet the requirements of § 25.791 of this chapter. Except as provided in paragraph (l) of this section, the signs must be constructed so that the crewmembers can turn them on and off.
- (b) Except as provided in paragraph (l) of this section, the "Fasten Seat Belt" sign shall be turned on during any movement on the surface, for each takeoff, for each landing, and at any other time considered necessary by the pilot in command.
- (c) No person may operate an aircraft on a flight on which smoking is prohibited by part 252 of this title unless either the "No Smoking" passenger information signs are lighted during the entire flight, or one or more "No Smoking" placards meeting the requirements of § 25.1541 of this chapter are posted during the entire flight segment. If both the lighted signs and the placards are used, the signs must remain lighted during the entire flight segment.
- (d) No person may operate a passenger carrying aircraft under this part unless at least one legible sign or placard that reads "Fasten Seat Belt While Seated" is visible from each passenger seat. These signs or placards need not meet the requirements of paragraph (a) of this section.
- (e) No person may operate an aircraft unless there is installed in each lavatory a sign or placard that reads: "Federal law provides for a penalty of up to \$2,000 for tampering with the smoke detector installed in this lavatory." These signs or placards need not meet the requirements of paragraph (a) of this section.
- (f) Each passenger required by § 121.311(b) to occupy a seat or berth shall fasten his or her safety belt about him or her and keep it fastened while the "Fasten Seat Belt" sign is lighted.

{New-2000-7 (g) revised June 9, 2000, effective June 4, 2000}

- (g) No person may smoke while a "No Smoking" sign is lighted or while "No Smoking" placards are posted, except as follows:
- (1) Supplemental operations. The pilot in command of an aircraft engaged in a supplemental operation may authorize smoking on the flight deck (if it is physically separated from any passenger compartment), but not in any of the following situations:
    - (i) During aircraft movement on the surface or during takeoff or landing;
    - (ii) During scheduled passenger-carrying public charter operations conducted under part 380 of this title; or
    - (iii) During any operation where smoking is prohibited by part 252 of this title or by international agreement.
  - (2) Certain intrastate domestic operations. Except during aircraft movement on the surface or during takeoff or landing, a pilot in command of an aircraft engaged in a domestic operation may authorize smoking on the flight deck (if it is physically separated from the passenger compartment) if--
    - (i) Smoking on the flight deck is not otherwise prohibited by part 252 of this title;
    - (ii) The flight is conducted entirely within the same State of the United States (a flight from one place in Hawaii to another place in Hawaii through the airspace over a place outside of Hawaii is not entirely within the same State); and
    - (iii) The aircraft is either not turbojet-powered or the aircraft is not capable of carrying at least 30 passengers.
- (h) No person may smoke in any aircraft lavatory.
- (i) No person may tamper with, disable, or destroy any smoke detector installed in any aircraft lavatory.
- (j) On flight segments other than those described in paragraph (c) of this section, the "No Smoking" sign must be turned on during any movement on the surface, for each takeoff, for each landing, and at any other time considered necessary by the pilot in command.
- (k) Each passenger shall comply with instructions given him or her by a crewmember regarding compliance with paragraphs (f), (g), (h), and (l) of this section.
- (l) A certificate holder may operate a nontransport category aircraft type certificated after December 31, 1964, that is manufactured before December 20, 1997, if it is equipped with at least one placard that is legible to each person seated in the cabin that states "Fasten Seat Belt," and if, during any movement on the surface, for each takeoff, for each landing, and at any other time considered necessary by the pilot in command, a crewmember orally instructs the passengers to fasten their seat belts.

[Doc. No. 25590, Amdt. 121-196, 53 FR 12361, Apr. 13, 1988; 53 FR 44182, Nov. 2, 1988; Amdt. 121-213, 55 FR 8367, March 7, 1990; Amdt. 121-230, 57 FR 42673, Sept. 15, 1992; Amdt. 121-251, 60 FR 65931, Dec. 20, 1995; Amdt. 121-256, 61 FR 30434, June 14, 1996, as corrected at 61 FR 35628, July 8, 1996, was Amdt. 121-259; Amdt. 121-277, 65 FR 36776, June 9, 2000, effective June 4, 2000]

## A.8.5

**§ 121.571 BRIEFING PASSENGERS BEFORE TAKEOFF**

- (a) Each certificate holder operating a passenger carrying aircraft shall insure that all passengers are orally briefed by the appropriate crewmember as follows:
- (1) Before each takeoff, on each of the following:
    - (i) Smoking. Each passenger shall be briefed on when, where, and under what conditions smoking is prohibited (including, but not limited to, any applicable requirements of part 252 of this title). This briefing shall include a statement that the Federal Aviation Regulations require passenger compliance with the lighted passenger information signs, posted placards, areas designated for safety purposes as no smoking areas, and crewmember instructions with regard to these items. The briefing shall also include a statement that Federal law prohibits tampering with, disabling, or destroying any smoke detector in an aircraft lavatory; smoking in lavatories; and, when applicable, smoking in passenger compartments.
    - (ii) The location of emergency exits.
    - (iii) The use of safety belts, including instructions on how to fasten and unfasten the safety belts. Each passenger shall be briefed on when, where, and under what conditions the safety belt must be fastened about that passenger. This briefing shall include a statement that the Federal Aviation Regulations require passenger compliance with lighted passenger information signs and crewmember instructions concerning the use of safety belts.
    - (iv) The location and use of any required emergency flotation means.
    - (v) Portable Electronic Device (PED) usage. Each passenger shall be briefed on when, where, and under what conditions PED usage is allowed. This briefing shall include a statement that the Federal Aviation Regulations require passenger compliance with the lighted passenger information signs, posted placards, areas designated for safety purposes as no PED usage areas, and crewmember instructions with regard to these items.
    - (vi) On operations that do not use a flight attendant, the following additional information:
      - (A) The placement of seat backs in an upright position before takeoff and landing.
      - (B) Location of survival equipment.
      - (C) If the flight involves operations above 12,000 MSL, the normal and emergency use of oxygen.
      - (D) Location and operation of fire extinguisher.
  - (2) After each takeoff, immediately before or immediately after turning the seat belt sign off, an announcement shall be made that passengers should keep their seat belts fastened, while seated, even when the seat belt sign is off.
  - (3) Except as provided in paragraph (a)(4) of this section, before each takeoff a required crewmember assigned to the flight shall conduct an individual briefing of each person who may need the assistance of another person to move expeditiously to an exit in the event of an emergency. In the briefing the required crewmember shall -
    - (i) Brief the person and his attendant, if any, on the routes to each appropriate exit and on the most appropriate time to begin moving to an exit in the event of an emergency; and

- (ii) Inquire of the person and his attendant, if any, as to the most appropriate manner of assisting the person so as to prevent pain and further injury.
- (4) The requirements of paragraph (a)(3) of this section do not apply to a person who has been given a briefing before a previous leg of a flight in the same aircraft when the crewmembers; on duty have been advised as to the most appropriate manner of assisting the person so as to prevent pain and further injury.  
 {New-2004-15 (b) revised June 29, 2004, effective "upon OMB approval of the information collection"}
- (b) Each certificate holder must carry on each passenger-carrying aircraft, in convenient locations for use of each passenger, printed cards supplementing the oral briefing. Each card must contain information pertinent only to the type and model of aircraft used for that flight, including--
  - (1) Diagrams of, and methods of operating, the emergency exits;
  - (2) Other instructions necessary for use of emergency equipment; and
  - (3) No later than June 12, 2005, for Domestic and Flag scheduled passenger-carrying flights, the sentence, "Final assembly of this aircraft was completed in [INSERT NAME OF COUNTRY]."  
 {Beginning of old text revised June 29, 2004, effective "upon OMB approval of the information collection"}
- (c) Each certificate holder shall carry on each passenger carrying aircraft, in convenient locations for use of each passenger, printed cards supplementing the oral briefing and containing -
  - (1) Diagrams of, and methods of operating, the emergency exits; and
  - (2) Other instructions necessary for use of emergency equipment.

Each card required by this paragraph must contain information that is pertinent only to the type and model aircraft used for that flight.
- (d) The certificate holder shall describe in its manual the procedure to be followed in the briefing required by paragraph (a) of this section.

[Amdt. 121-2, 30 FR 3206, Mar. 9, 1965, as amended by Amdt. 121-30, 32 FR 13268, Sept. 20, 1967; Amdt. 121-84, 37 FR 3975, Feb. 24, 1972; Amdt. 121-133, 42 FR 18394, Apr. 7, 1977; Amdt. 121-144, 43 FR 22648, May 25, 1978; Amdt. 121-146, 43 FR 28403, June 29, 1978; Amdt. 121-196, 53 FR 12362, Apr. 13, 1988; Amdt. 121-230, 57 FR 42674, Sept. 15, 1992; Amdt. 121-251, 60 FR 65935, Dec. 20, 1995; 69 FR 39292, June 29, 2004, effective "upon OMB approval of the information collection"]

**ANNEX 9****INDEX OF DEFINITIONS**

16 QAM	16- Quadrature Amplitude Modulation
3GPP2	Third-Generation Partnership Project 2
ADC	American Digital Cellular System
AM	Amplitude Modulation
AMPS	Advanced Mobile Phone Standard
BPSK	Binary Phase Shift Keying
C4FM	Constant Envelope 4 Level Frequency Modulation
CDMA	Code Division Multiple Access
CSMA	Carrier Sense Multiple Access
CW	Continuous Wave
DAMPS	Digital American Mobile Phone System Standard
DCS1800	(See PCS1900)
DSSS	Direct Sequence Spread Spectrum
DQPSK	Differential Quadrature Phase Shift Keying
DUI	Device under investigation
EDACS	Enhanced Digital Access Communication System
EMC	Electromagnetic Compatibility
EMI	Electromagnetic Interference
EIRP	Effective Isotropic Radiated Power
ERP	Effective Radiated Power
ETSI	European Telecommunication Standards Institute
EUT	Equipment under test
FCC	Federal Communication Commission
FDD	Frequency Division Duplex
FDMA	Frequency Division Multiple Access
FHSS	Frequency Hopping Spread Spectrum
FM	Frequency Modulation
FSK	Frequency Shift Keying
GSM	Global System for Mobile telephony
GMSK	Gaussian Minimum Shift Keying
GPRS	General Packet Radio Service
HIRF	High Intensity Radiated Field
HSCSD	High Speed Circuit Switched Data
i-DEN	Proprietary mobile phone standard by Motorola
IRA	Intentional Radiated emissions coupled through Antennas
IRC	Intentional Radiated emissions coupled through Cables

IRU	Intentional Radiated emissions coupled onto Units
IS-136	basis of the TDMA cellular and personal communication services (PCS)
IS-54/ IS-136	Second- generation (2G) mobile phone system
ISM	Industrial, Scientific, Medical
LRU	Line Replaceable Unit
MEF	Multiple Equipment Factor
MEL	Minimum Equipment List
MPT-1327	Trunked Radio Standard developed by the British Department of Trade and Industry
M-QAM	Multiple Quadrature Amplitude Modulation
Mobitex II	International Mobile Communication Standard developed by Ericsson
NAMPS	North American Mobile Phone System Standard
NIRA	Non Intentional Radiated emissions coupled through Antennas
NIRC	Non Intentional Radiated emissions coupled through Cables
NIRU	Non Intentional Radiated emissions coupled onto Units
OFDM	Orthogonal Frequency Division Multiplex
OQPSK	Offset Quadrature Phase Shift Keying
PCS1900	Personal Communication System 1900. PCS1900 is not a standardized system but refers to a collection of mobile systems that operate in the 1900 MHz band in the United States. One of these systems is a derivative of the GSM or DCS1800. Other standards are CDMA/IS-95 and TDMA/IS-136.
PDC	Personal Digital Cellular
PHS	Personal Handy phone Standard
PMR	Personal (or Professional) Mobile Radio, e.g. PMR 446
PRF	Pulse Repetition Frequency
PROJECT 25/APCO25	Mobile Communication Standard for e.g. governmental and public safety use
QPSK	Quadrature Phase Shift Keying
RS	Radiated Susceptibility
TDD	Time Division Duplex
TDMA	Time Division Multiple Access
TETRA	Terrestrial Trunked Radio Standard
TETRAPOL	Terrestrial Trunked Radio Standard, e.g. for the public safety sector
T-PED	Intentionally transmitting portable electronic device
UMTS	Universal Mobile Telecommunication System
USDC	US digital Cellular
WLAN	Wireless Local Area Network



## ANNEX 10

### INDEX OF REFERENCES

- [1] RTCA DO-294, "Guidance on Allowing Transmitting Portable Electronic Devices (T-PEDs) onboard Aircraft", prepared by SC-202, October 2004
- [2] ED-118, "Report on electromagnetic compatibility between passenger carried portable electronic devices (PEDS) and aircraft systems", November 2003.
- [3] International Commission on Non-Ionizing Radiation Protection (ICNIRP), "Guidelines for Limiting Exposure to Time-Varying Electric, Magnetic and Electromagnetic Fields (up to 300 GHz)", 1998.
- [4] Robert Kebel, Philipp Argus: "Assessment of Multiple Equipment Electromagnetic Emissions", RTCA DO-294, prepared by SC-202, Appendix 5.E, Hamburg, November 2003
- [5] JAA TGL Nr. 29, "Guidance concerning the use of Portable Electronic Devices onboard Aircraft", JAA Administrative and Guidance material, October 2001.
- [6] EUROCAE WG58, "Report on electromagnetic compatibility between passenger carried Portable Electronic Devices (PEDs) and aircraft systems", October 2003
- [7] RTCA DO-233, "Portable Electronic Devices Carried Onboard Aircraft", RTCA, August 1996.
- [8] LAN/MAN STANDARDS COMMITTEE, "Supplement to IEEE Standard for Information Technology, PART 11: Wireless LAN Medium Access Control (MAC) and Physical Layer (PHY) specifications: Higher-Speed Physical Layer Extension in the 2.4 GHz Band", p. 52, IEEE Computer Society.
- [9] EN 61000-4-3, "Electromagnetic Compatibility", Appendix A, November 2003.
- [10] Bluetooth, "Specification of the Bluetooth System", version 1.1, Part A: Radio Specification, February 22 2001
- [11] TIA/EIA/IS-91-A, "Base Station-Mobile Station Compatibility Specification for 800 MHz Cellular, Auxiliary and Residential Services", Telecommunications Industry association, November 1999.
- [12] TIA/EIA-95-B, "Base Station-Mobile Station Compatibility Specification for Wideband Spread Spectrum Cellular Systems", Telecommunications Industry association, March 1999.
- [13] ARIB STD-53-C.S0002-B, "Physical Layer Standard for CDMA2000 Spread Spectrum Systems", Association of Radio Industries and Business, April 19 2002.
- [14] Gunnar Heine, "GSM Networks: Protocols, Terminology and Implementation", Artech House, Boston London, 1999.
- [15] MOTOROLA, "Software Release 9.1: iDEN Technical Overview", Chapter 3: Operating Characteristics, 68P81095E55-E, August 2000.
- [16] ARIB RCR STD-27 J, "Personal Digital Cellular Telecommunication System ARIB Standard", Chapter 3: Technical Requirements for Radio Facilities, Association of Radio Industries and Business, May 30 2002.
- [17] Dr.-Ing. Wolfgang Granzow, "3rd Generation Mobile Communications Systems", version 1.12, August 1 2000.
- [18] ETSI TR 101 683, "Broadband Radio Access Networks (BRAN), HYPERLAN Type 2, System Overview", Chapter 5: Spectrum Utilization Parameters, V1.1.1, ETSI, February 2002.
- [19] ETSI EN 300 328-1, "Electromagnetic compatibility and Radio spectrum Matters (ERM); Wideband Transmission systems; Data transmission equipment operating in the 2,4 GHz ISM band and using spread spectrum modulation techniques; Part 1: Technical characteristics and test conditions", Chapter 5: Technical Characteristics, V1.3.1, ETSI, December 2001.

- [20] LAN MAN Standards Committee of the IEEE Computer Society, "Information technology Telecommunications and information exchange between systems; local and metropolitan area networks; specific requirements; part 11: Wireless LAN Medium Access Control (MAC) and Physical Layer (PHY) Specifications", ANSI/IEEE Standard 802.11, 1999.
- [21] Bill Strauss, thesis, "Portable Electronic Devices Onboard Commercial Aircraft: Assessing the risks".
- [22] Bill Strauss, M. Granger Morgan, Jay Apt, Daniel D. Stancil, "Unsafe At Any Airspeed?", IEEE Spectrum, March 2006.



## CHAPTER 6

### ED-130 IMPROVEMENT SUGGESTION FORM

Name: \_\_\_\_\_ Company: \_\_\_\_\_

Address: \_\_\_\_\_

City: \_\_\_\_\_ State, Province: \_\_\_\_\_

Postal Code, Country: \_\_\_\_\_ Date: \_\_\_\_\_

Phone: \_\_\_\_\_ Fax: \_\_\_\_\_

Email: \_\_\_\_\_

DOCUMENT : ED-130                      SEC: \_\_\_\_\_ PAGE: \_\_\_\_\_ LINE: \_\_\_\_\_

- [ ] Documentation error (Format, punctuation, spelling)
- [ ] Content error
- [ ] Enhancement or refinement

Rationale (Describe the error or justification for enhancement): \_\_\_\_\_

---

---

Proposed change (Attach marked-up text or proposed rewrite): \_\_\_\_\_

---

---

---

---

Please provide any general comments for improvement of this document:

---

---

---

---

---

Return completed form to:

**EUROCAE**  
Attention: **Secretary-General ED-130**  
102 rue Etienne Dolet  
92240 MALAKOFF, France  
Email: [eurocae@eurocae.net](mailto:eurocae@eurocae.net)

## ATTACHMENT 2

### “STOP BUZZER” CONTACT

The follow Panasonic personnel will be present and have “stop buzzer” authority to order the immediate cessation of all test activities should report(s) of interference be reported at the test sites:

<b>Name</b>	<b>Email</b>	<b>Mobile Number</b>
Bassam Chamas – Lead*	Bassam.Chamas@panasonic.aero	(949) 505-3084

\*Additional “stop buzzer” contacts will be identified when specific test dates are confirmed.