

Pre-Transaction Organizational Structure

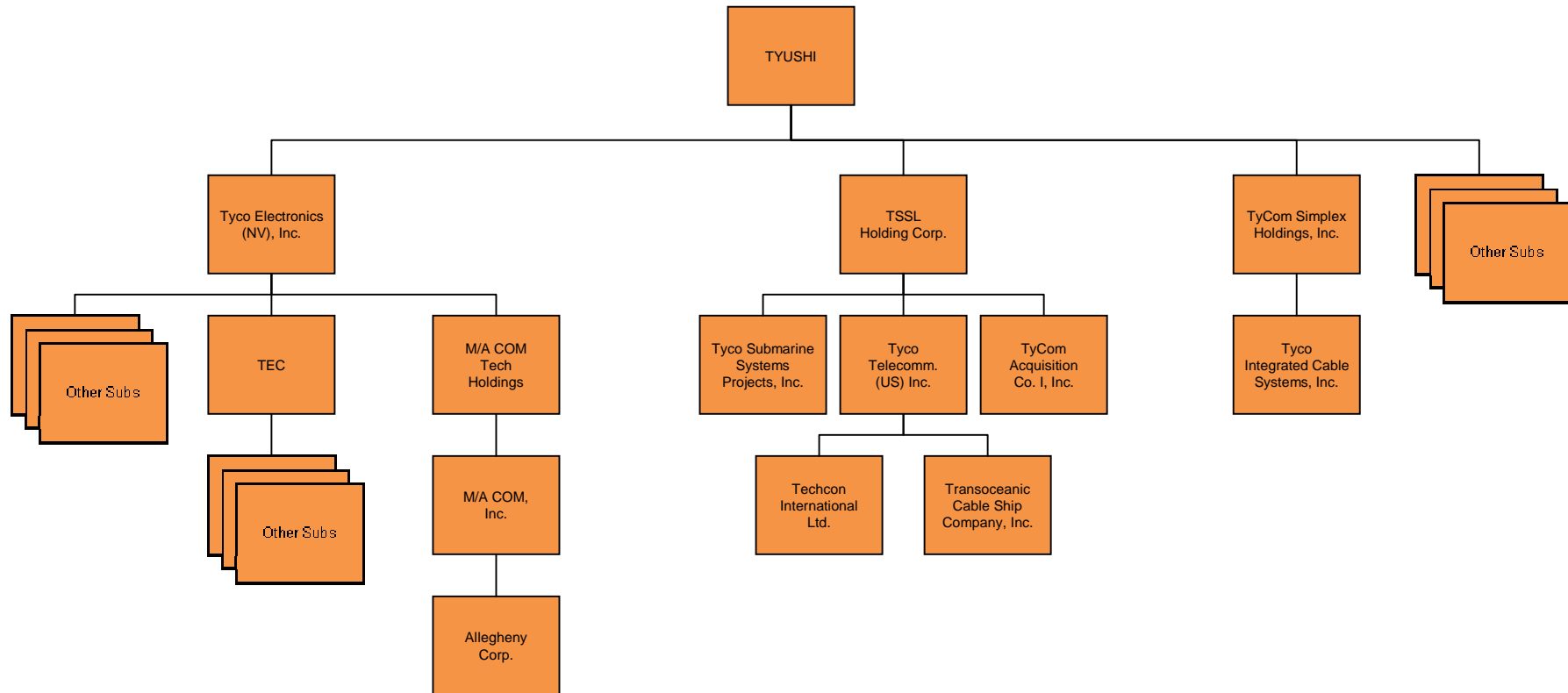

Step 1 – Holding Corporation Merger

Step 1:

TSSL Holding Corp merges under state law with and into TYUSHI with TYUSHI surviving:

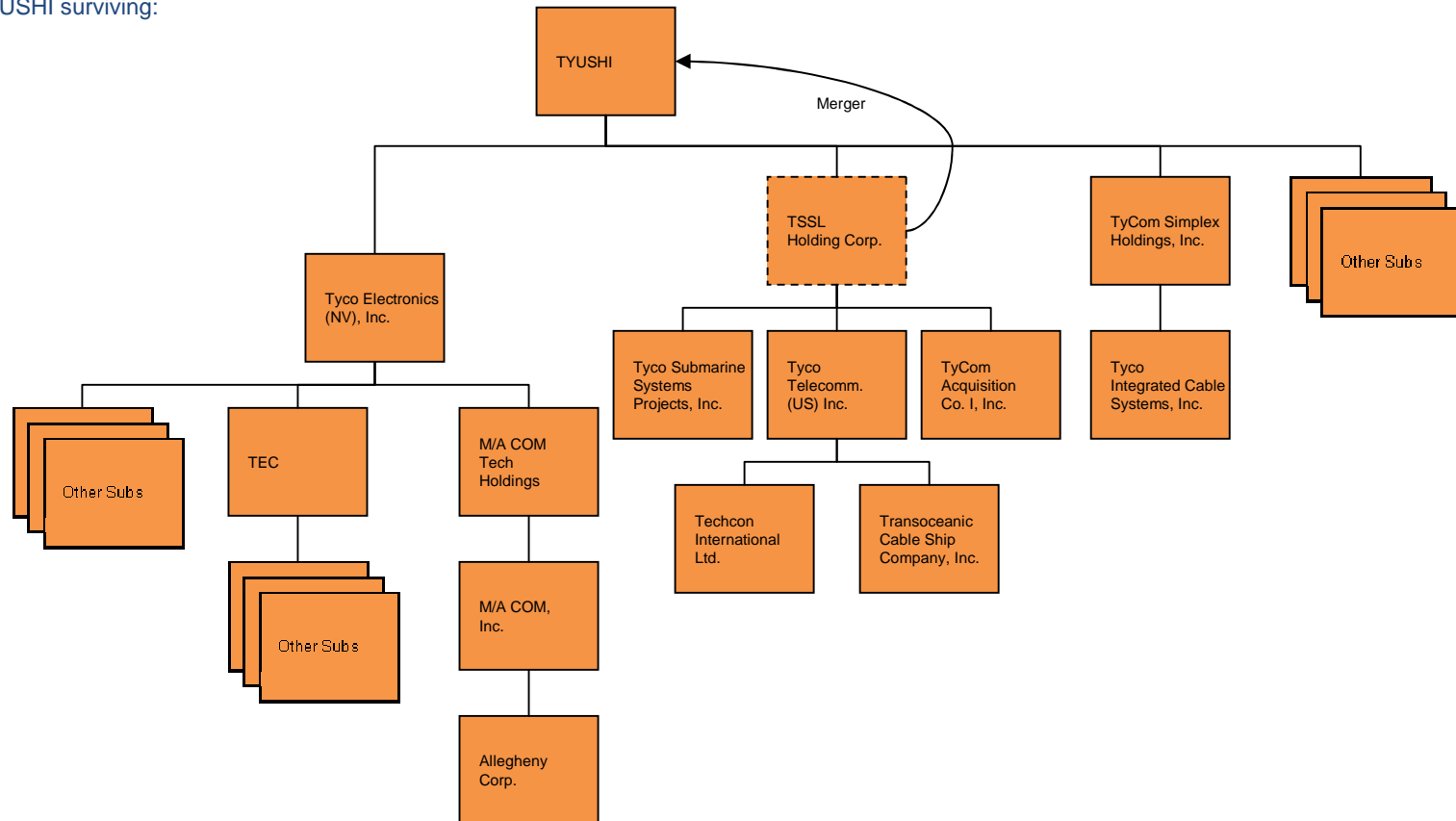

Step 2 – Holding Corporation Merger

Step 2:

TyCom Simplex Holdings, Inc. merges under state law with and into TYUSHI with TYUSHI surviving:

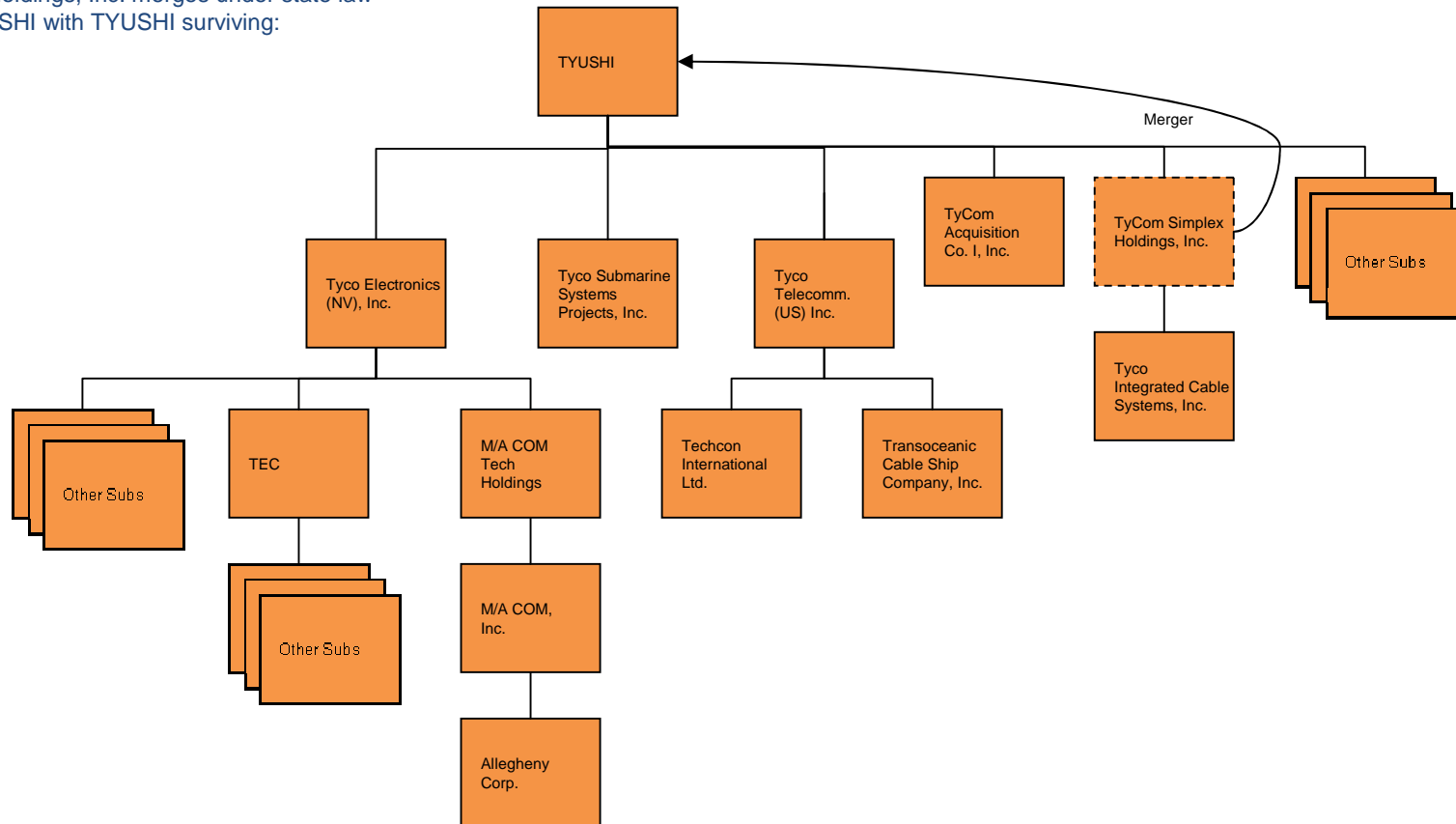

Step 3 – Holding Corporation Merger

Step 3:

M/A COM Tech Holdings, Inc. merges under state law with and into Tyco Electronics (NV), Inc. with Tyco Electronics (NV), Inc. surviving:

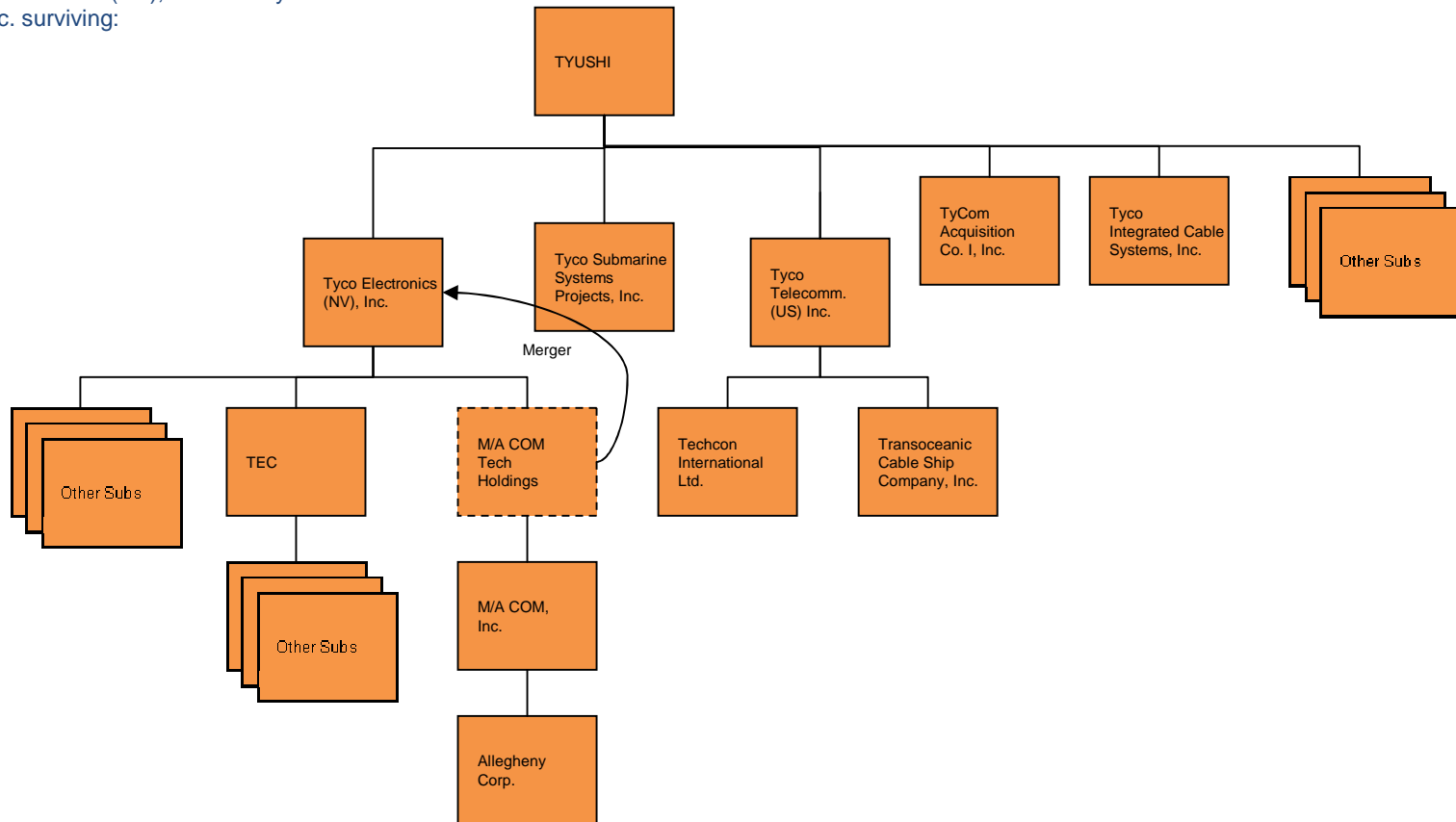

Step 4 – TICS Contribution

Step 4:

TYUSHI transfers the stock of Tyco Integrated Cable Systems, Inc. to Tyco Telecommunications (US) Inc. as a contribution to Tyco Telecommunications (US) Inc.'s capital.

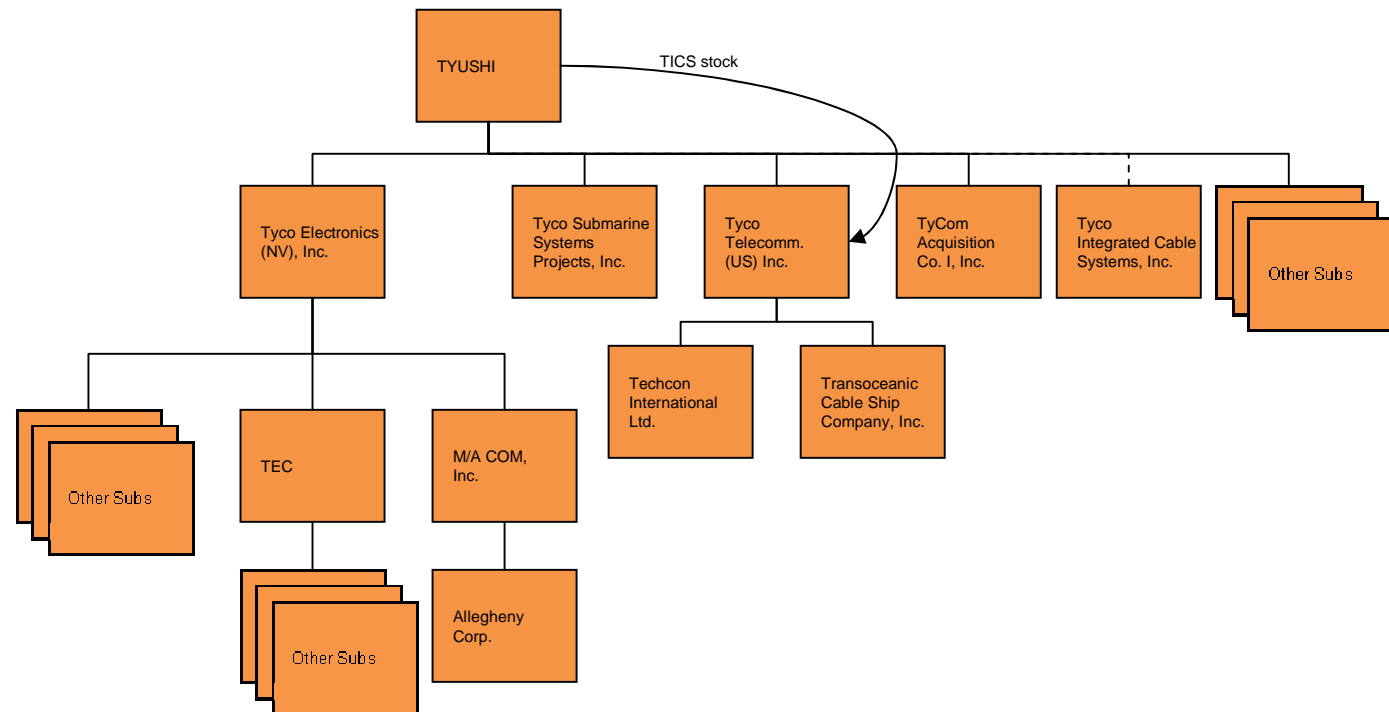

Step 5 – Tyco Telecom Contribution

Step 5:

TYUSHI transfers the stock of Tyco Telecommunications (US) Inc. to Tyco Electronics (NV), Inc. as a contribution to Tyco Electronics (NV), Inc.'s capital.

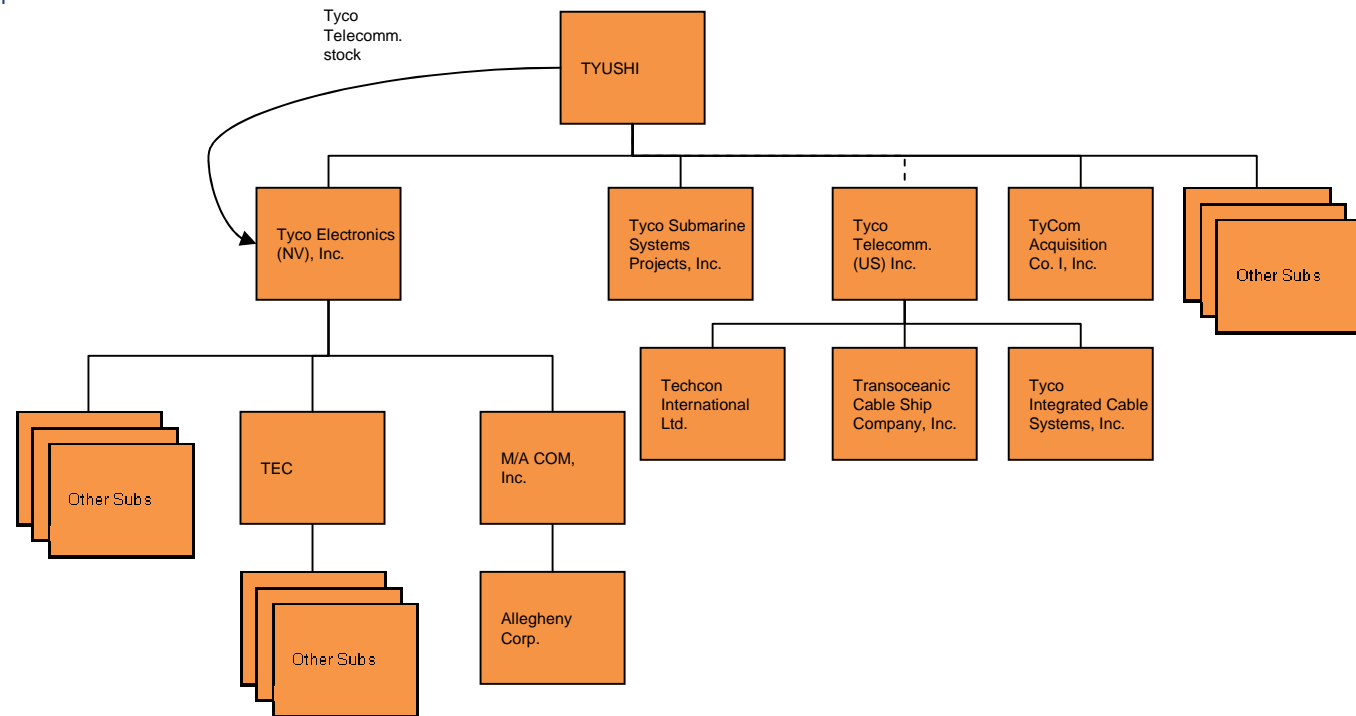

Step 6 – M/A-COM Contribution

Step 6:

Tyco Electronics (NV), Inc. transfers the stock of M/A COM, Inc. to Tyco Telecommunications (US) Inc. as a contribution to Tyco Telecommunications (US) Inc.'s capital.

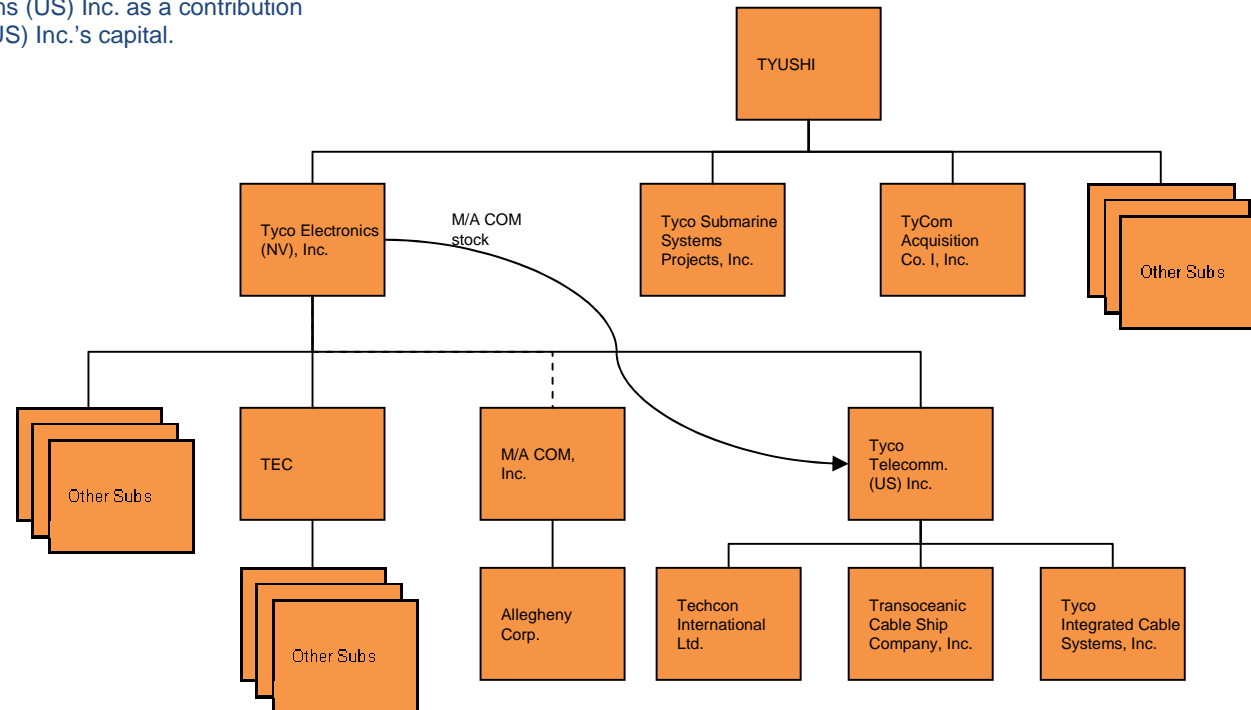

Post-Transaction Organizational Structure

