



Flom Test Labs
EMI, EMC, RF Testing Experts Since 1963

toll-free: (866) 311-3268
fax: (480) 926-3598
<http://www.flomlabs.com>
info@flomlabs.com

Date: December 9, 2005

Federal Communications Commission
Via: Electronic Filing

Attention: Authorization & Evaluation Division

Applicant: Kenwood USA Corporation
Equipment: TK-5300-1
FCC ID: ALH37164110
FCC Rules: 2, 90, 90.210 and Confidentiality

Gentlemen:

On behalf of the Applicant, enclosed please find Application Form 731, Engineering Test Report and all pertinent documentation, the whole for approval of the referenced equipment as shown.

Filing fees are attached.

We trust the same is in order. Should you need any further information, kindly contact the writer who is authorized to act as agent.

Sincerely yours,

David E. Lee, FCC Compliance Manager

enclosure(s)
cc: Applicant
DEL/del

Flom Test Labs
3356 N. San Marcos Place, Suite 107
Chandler, Arizona 85225-7176
(866) 311-3268 phone, (480) 926-3598 fax

FCC ID: ALH37164110
MFA p05b0013, d05c0015



Flom Test Labs
EMI, EMC, RF Testing Experts Since 1963

toll-free: (866) 311-3268
fax: (480) 926-3598
<http://www.flomlabs.com>
info@flomlabs.com

Transmitter Certification

of

Model: TK-5300-1
FCC ID: ALH37164110

to

Federal Communications Commission

Rule Parts 90, 90.210 and Confidentiality

Date of report: December 9, 2005

On the Behalf of the Applicant:

Kenwood USA Corporation

At the Request of:

Kenwood USA Corporation
Communications Division
3975 Johns Creek Court, Suite 300
Suwanee, GA 30024

Attention of:

Joel E. Berger, Research & Development
JBerger@kenwoodusa.com
(678) 474-4722; FAX: -4731

Supervised by:

David E. Lee, FCC Compliance Manager

List of Exhibits

(FCC Certification (Transmitters) - Revised 9/28/98)

Applicant: Kenwood USA Corporation

FCC ID: ALH37164110

By Applicant:

1. Letter of Authorization
2. Confidentiality Request: 0.457 And 0.459
3. Part 90.203(e) & (g) Attestation
4. Identification Drawings, 2.1033(c)(11)
 - Label
 - Location of Label
 - Compliance Statement
 - Location of Compliance Statement
5. Photographs, 2.1033(c)(12)
6. Documentation: 2.1033(c)
 - (3) User Manual
 - (9) Tune Up Info
 - (10) Schematic Diagram
 - (10) Circuit Description
 - Block Diagram
 - Parts List
 - Active Devices
7. SAR Report

By M.F.A. Inc.:

- A. Testimonial & Statement of Certification

The Applicant has been cautioned as to the following:

15.21 Information to the User.

The users manual or instruction manual for an intentional radiator shall caution the user that changes or modifications not expressly approved by the party responsible for compliance could void the user's authority to operate the equipment.

15.27(a) Special Accessories.

Equipment marketed to a consumer must be capable of complying with the necessary regulations in the configuration in which the equipment is marketed. Where special accessories, such as shielded cables and/or special connectors are required to enable an unintentional or intentional radiator to comply with the emission limits in this part, the equipment must be marketed with, i.e. shipped and sold with, those special accessories. However, in lieu of shipping or packaging the special accessories with the unintentional or intentional radiator, the responsible party may employ other methods of ensuring that the special accessories are provided to the consumer, without additional charge.

Information detailing any alternative method used to supply the special accessories for a grant of equipment authorization or retained in the verification records, as appropriate. The party responsible for the equipment, as detailed in § 2.909 of this chapter, shall ensure that these special accessories are provided with the equipment. The instruction manual for such devices shall include appropriate instructions on the first page of text concerned with the installation of the device that these special accessories must be used with the device. It is the responsibility of the user to use the needed special accessories supplied with the equipment.

Table of Contents

<u>Rule</u>	<u>Description</u>	<u>Page</u>
2.1033(c)(14)	Rule Summary	2
	Standard Test Conditions and Engineering Practices	3
2.1033(c)	General Information Required	4
2.1046(a)	Carrier Output Power (Conducted)	7
2.1046(a)	ERP Carrier Power (Radiated)	9
2.1051	Unwanted Emissions (Transmitter Conducted)	11
2.1053(a)	Field Strength of Spurious Radiation	13
2.1049(c)(1)	Emission Masks (Occupied Bandwidth)	17
90.214	Transient Frequency Behavior	32
2.1047(a)	Audio Low Pass Filter (Voice Input)	38
2.1047(a)	Audio Frequency Response	40
2.1047(b)	Modulation Limiting	42
2.1055(a)(1)	Frequency Stability (Temperature Variation)	44
2.1055(b)(1)	Frequency Stability (Voltage Variation)	46
2.202(g)	Necessary Bandwidth and Emission Bandwidth	48

Required information per ISO/IEC Guide 25-1990, paragraph 13.2:

- a) **Test Report**
- b) Laboratory: M. Flom Associates, Inc.
(FCC: 31040/SIT) 3356 N. San Marcos Place, Suite 107
(Canada: IC 2044) Chandler, AZ 85225
- c) Report Number: d05c0015
- d) Client: Kenwood USA Corporation
Communications Division
3975 Johns Creek Court, Suite 300
Suwanee, GA 30024
- e) Identification: TK-5300-1
FCC ID: ALH37164110
EUT Description: UHF/FM Transceiver, Handheld
- f) EUT Condition: Not required unless specified in individual tests.
- g) Report Date: December 9, 2005
EUT Received: November 29, 2005
- h, j, k): As indicated in individual tests.
- i) Sampling method: No sampling procedure used.
- l) Uncertainty: In accordance with MFA internal quality manual.
- m) Supervised by: 
David E. Lee, FCC Compliance Manager
- n) Results: The results presented in this report relate only to the item tested.
- o) Reproduction: This report must not be reproduced, except in full, without written permission from this laboratory.

Sub-part
2.1033(c)(14):

Test and Measurement Data

All tests and measurement data shown were performed in accordance with FCC Rules and Regulations, Volume II; Part 2, Sub-part J, Sections 2.947, 2.1033(c), 2.1041, 2.1046, 2.1047, 2.1079, 2.1051, 2.1053, 2.1055, 2.1057 and the following individual Parts:

- 21 – Domestic Public Fixed Radio Services
- 22 – Public Mobile Services
- 22 Subpart H - Cellular Radiotelephone Service
- 22.901(d) - Alternative technologies and auxiliary services
- 23 – International Fixed Public Radiocommunication services
- 24 – Personal Communications Services
- 74 Subpart H - Low Power Auxiliary Stations
- 80 – Stations in the Maritime Services
- 80 Subpart E - General Technical Standards
- 80 Subpart F - Equipment Authorization for Compulsory Ships
- 80 Subpart K - Private Coast Stations and Marine Utility Stations
- 80 Subpart S - Compulsory Radiotelephone Installations for Small Passenger Boats
- 80 Subpart T - Radiotelephone Installation Required for Vessels on the Great Lakes
- 80 Subpart U - Radiotelephone Installations Required by the Bridge-to-Bridge Act
- 80 Subpart V - Emergency Position Indicating Radio Beacons (EPIRB'S)
- 80 Subpart W - Global Maritime Distress and Safety System (GMDSS)
- 80 Subpart X - Voluntary Radio Installations
- 87 – Aviation Services
- 90 – Private Land Mobile Radio Services
- 94 – Private Operational-Fixed Microwave Service
- 95 Subpart A - General Mobile Radio Service (GMRS)
- 95 Subpart C - Radio Control (R/C) Radio Service
- 95 Subpart D - Citizens Band (CB) Radio Service
- 95 Subpart E - Family Radio Service
- 95 Subpart F - Interactive Video and Data Service (IVDS)
- 97 - Amateur Radio Service
- 101 – Fixed Microwave Services



Standard Test Conditions and Engineering Practices

Except as noted herein, the following conditions and procedures were observed during the testing:

In accordance with ANSI C63.4-2003, and unless otherwise indicated in the specific measurement results, the ambient temperature of the actual EUT was maintained within the range of 10° to 40°C (50° to 104 °F) unless the particular equipment requirements specify testing over a different temperature range. Also, unless otherwise indicated, the humidity levels were in the range of 10% to 90% relative humidity.

Prior to testing, the EUT was tuned up in accordance with the manufacturer's alignment procedures. All external gain controls were maintained at the position of maximum and/or optimum gain throughout the testing.

Measurement results, unless otherwise noted, are worst-case measurements.

 <p style="text-align: center;">A2LA</p> <p style="text-align: center;">THE AMERICAN ASSOCIATION FOR LABORATORY ACCREDITATION</p> <p style="text-align: center;">ACCREDITED LABORATORY</p> <p>A2LA has accredited</p> <p style="text-align: center;">M. FLOM ASSOCIATES, INC. Chandler, AZ</p> <p>for technical competence in the field of</p> <p style="text-align: center;">Electrical Testing</p> <p><small>The accreditation covers the specific tests and types of tests listed on the agreed scope of accreditation. This laboratory meets the requirements of ISO/IEC 17025-1999 'General Requirements for the Competence of Testing and Calibration Laboratories' and any additional program requirements in the identified field of testing.</small></p> <p><small>Presented this 14th day of June 2004.</small></p> <div style="display: flex; justify-content: space-around; align-items: center;">  <div style="text-align: center;">  <small>President For the Accreditation Council Certificate Number: 2152-01 Valid to August 31, 2006</small> </div> </div> <p><small>For tests or types of tests to which this accreditation applies, please refer to the laboratory's Electrical Scope of Accreditation.</small></p>	<h3 style="margin-top: 0;">A2LA</h3> <hr/> <p>“A2LA has accredited M. Flom Associates, Inc. Chandler, AZ for technical competence in the field of Electrical Testing. The accreditation covers the specific tests and types of tests listed on the agreed scope of accreditation. This laboratory meets the requirements of ISO/IEC 17025 – 1999 ‘General Requirements for the Competence of Testing and Calibration Laboratories’ and any additional program requirements in the identified field of testing.”</p> <hr/> <p>Certificate Number: 2152-01</p>
---	---

List of General Information Required for Certification

In Accordance with FCC Rules and Regulations,
 Volume II, Part 2 and to 90.210, Confidentiality

Sub-part 2.1033

(c)(1): **Name and Address of Applicant:**

Kenwood USA Corporation
 Communications Division
 3975 Johns Creek Court, Suite 300
 Suwanee, GA 30024

Manufacturer:

Kenwood Electronics Technologies PTE Ltd.
 1 Ang Mo Kio Street 63
 Singapore 569110

(c)(2): **FCC ID:** ALH37164110

Model Number: TK-5300-1

(c)(3): **Instruction Manual(s):**

Please see attached exhibits

(c)(4): **Type of Emission:** 11K0F3E, 6K00F1E, 6K00F1D

(c)(5): **Frequency Range, MHz:** 450.00 – 485.10

(c)(6): **Power Rating, Watts:** 5W
 _____ Switchable X Variable _____ N/A

FCC Grant Note: BF

(c)(7): **Maximum Power Rating, Watts:** 300

DUT Results: Passes X Fails _____

Information for Push-To-Talk Devices

Type and number of antenna to be used for this device:

2, Whip

Maximum antenna gain for antenna indicated above:

0dBi

Can this device sustain continuous operation with respect to its hardware capabilities and allowable operating functions?

No, Duty Cycle Limited

Other hardware or operating restrictions that could limit a person's RF Exposure:

Time Out Timer

Source-based time-averaging (see 2.1093 of rules) applicable to reduce the average output power:

No

If device has headset and belt-clip accessories that would allow body-worn operations, what is the minimum separation distance between the antenna and the user's body in this operating configuration?

2.5cm

Can device access wire-line services to make phone calls, either directly or through an operator?

No

Can specific operating instructions be given to users to eliminate any potential RF Exposure concerns for both front-of-the-face and body-worn operating configurations?

Yes, In Manual

Other applicable information the applicant may provide that can serve as effective means for ensuring RF Exposure compliance:

Training per Manual

Subpart 2.1033 (continued)

(c)(8): Voltages & currents in all elements in final RF stage, including final transistor or solid-state device:

Collector Current, A	=	2.3
Collector Voltage, Vdc	=	6.0
Supply Voltage, Vdc	=	7.5

(c)(9): **Tune-Up Procedure:**

Please see attached exhibits

(c)(10): **Circuit Diagram/Circuit Description:**

Including description of circuitry & devices provided for determining and stabilizing frequency, for suppression of spurious radiation, for limiting modulation and limiting power.

Please see attached exhibits

(c)(11): **Label Information:**

Please see attached exhibits

(c)(12): **Photographs:**

Please see attached exhibits

(c)(13): **Digital Modulation Description:**

Attached Exhibits
 N/A

(c)(14): **Test and Measurement Data:**

Follows

Name of Test: Carrier Output Power (Conducted)
Specification: 47 CFR 2.1046(a)
Guide: ANSI/TIA/EIA-603-1992, Paragraph 2.2.1

Measurement Procedure

- A) The EUT was connected to a resistive coaxial attenuator of normal load impedance, and the unmodulated output power was measured by means of an RF Power Meter.
- B) Measurement accuracy is $\pm 3\%$.

Transmitter Test Set-Up: RF Power Output

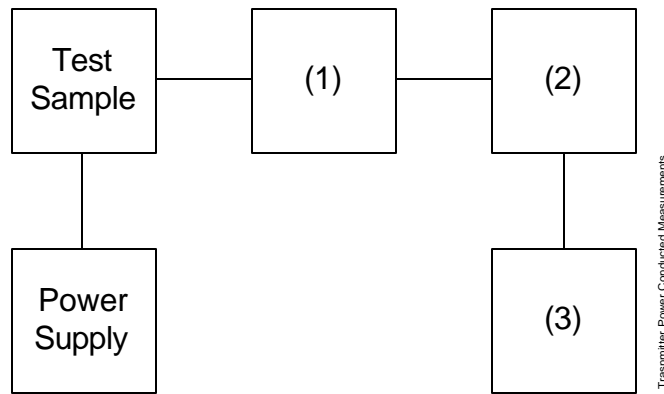

Asset	Description	s/n	Cycle	Last Cal
(1)	Coaxial Attenuator			
X	i00231/2 PASTERNAK PE7021-30 (30 dB)	231 or 232	NCR	
	i00122/3 NARDA 766 (10 dB)	7802 or 7802A	NCR	
(2)	Power Meters			
X	i00020 HP 8901A Power Mode	2105A01087	12 mo.	Apr-05
(3)	Frequency Counter			
X	i00020 HP 8901A Frequency Mode	2105A01087	12 mo.	Apr-05

Name of Test: Carrier Output Power (Conducted)

Measurement Results
(Worst case)

Frequency of Carrier, MHz = 450.05, 467.05, 485.05
Ambient Temperature = 23°C ± 3°C

Power Setting	RF Power, dB	RF Power, Watts
High	36.9	4.89
Low	30.0	1.00



Performed by:

Fred Chastain, Test Technician

Name of Test: ERP Carrier Power (Radiated)

Specification: TIA/EIA 603A (Substitution Method)

Measurement Procedure

Definition

The average radiated power of a licensed device is the equivalent power required, when delivered to a half-wave dipole or horn antenna, to produce at a distant point the same average received power as produced by the licensed device.

Method of Measurement:

- A) Connect the equipment as illustrated. Place the transmitter to be tested on the turntable in the standard test site.

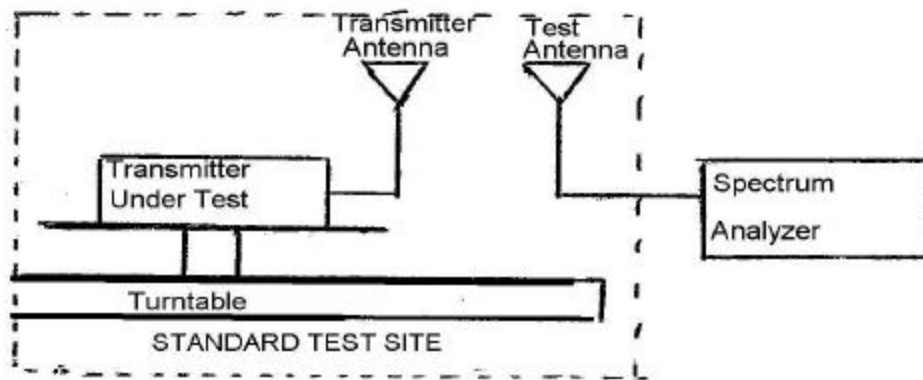

- B) Raise and lower the test antenna from 1m to 6 m with the transmitter facing the antenna and record the highest received signal in dB as LVL.
- C) Repeat step B) for seven additional readings at 45° interval positions of the turntable.
- D) Replace the transmitter under test with a half-wave or horn vertically polarized antenna. The center of the antenna should be at the same location as the transmitter under test. Connect the antenna to a signal generator with a known output power and record the path loss in dB or LOSS.
- E) Calculate the average radiated output power from the readings in step C) and D) by the following:

$$\text{average radiated power} = 10 \log_{10} \left(\frac{10(LVL - LOSS)}{10} \right) \text{ (dBm)}$$

Name of Test: ERP Carrier Power (Radiated)

Test Equipment

Asset	Description	s/n	Cycle	Last Cal
Transducer				
i00088	EMCO 3109-B 25MHz-300MHz	2336	24 mo.	Sep-05
X i00089	Aprel 2001 200MHz-1GHz	001500	24 mo.	Sep-05
X i00103	EMCO 3115 1GHz-18GHz	9208-3925	24 mo.	Sep-05
Amplifier				
X i00028	HP 8449A	2749A00121	12 mo.	May-05
Spectrum Analyzer				
X i00029	HP 8563E	3213A00104	12 mo.	May-05
X i00033	HP 85462A	3625A00357	12 mo.	Jul-05
Substitution Generator				
X i00067	HP 8920A Communication TS	3345U01242	12 mo.	Jun-05
i00207	HP 8753D Network Analyzer	3410A08514	12 mo.	Jul-05

Measurement Results

	450.050 MHz		467.050 MHz		485.050 MHz	
	LVL, dbm	Path Loss, db	LVL, dbm	Path Loss, db	LVL, dbm	Path Loss, db
0°	32.8	4.1	36.1	4.3	36.1	4.0
45°	32.2	4.1	33.8	4.3	35.6	4.0
90°	29.0	4.1	32.4	4.3	35.1	4.0
135°	29.4	4.1	30.5	4.3	30.2	4.0
180°	28.3	4.1	29.8	4.3	29.6	4.0
225°	23.7	4.1	27.9	4.3	29.4	4.0
270°	29.7	4.1	29.2	4.3	30.1	4.0
315°	30.1	4.1	32.3	4.3	32.3	4.0
Av. Radiated Power:		450.050 MHz	467.050 MHz	485.050 MHz		
		33.5 dBm	35.8 dBm	36.3 dBm		



Performed by:

Fred Chastain, Test Technician

Name of Test: Unwanted Emissions (Transmitter Conducted)

Specification: 47 CFR 2.1051

Guide: ANSI/TIA/EIA-603-1992, Paragraph 2.2.13

Measurement Procedure

- A) The emissions were measured for the worst case as follows:
 - 1). within a band of frequencies defined by the carrier frequency plus and minus one channel.
 - 2). from the lowest frequency generated in the EUT and to at least the 10th harmonic of the carrier frequency, or 40 GHz, whichever is lower.
- B) The magnitude of spurious emissions that are attenuated more than 20 dB below the permissible value need not be specified.

Transmitter Test Set-Up: Spurious Emission

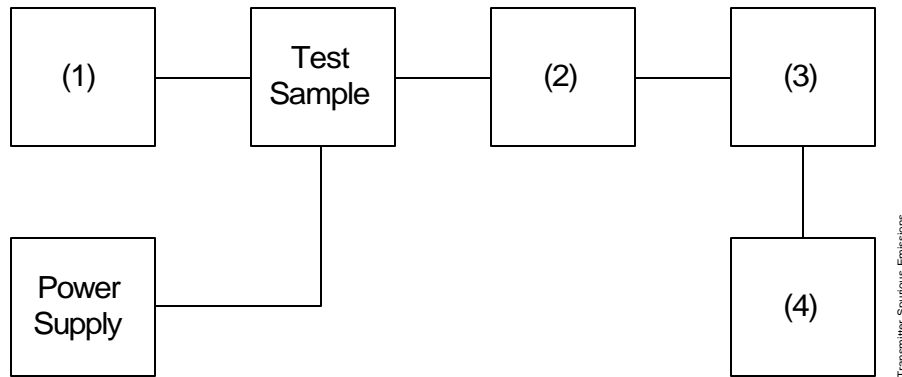

Asset	Description	s/n		
(1) Audio Oscillator/Generator				
X	i00017	HP 8903A Audio Analyzer	2216A01753	12 mo. Apr-05
	i00002	HP 3336B Synthesizer / Level Gen.	1931A01465	12 mo. Apr-05
(2) Coaxial Attenuator				
X	i00231/2	PASTERNAK PE7021-30 (30 dB)	231 or 232	NCR
	i0012/3	NARDA 766 (10 dB)	7802 or 7802A	NCR
(3) Filters; Notch, HP, LP, BP				
	None required			
(4) Spectrum Analyzer				
X	i00048	HP 8566B Spectrum Analyzer	2511A01467	12 mo. Oct-05
	i00029	HP 8563E Spectrum Analyzer	3213A00104	12 mo. May-05

Name of Test: Unwanted Emissions (Transmitter Conducted)

Measurement Results
(Worst Case)

Summary:

Frequency of carrier, MHz	=	450.05, 467.05, 485.05
Spectrum Searched, GHz	=	0 to 10 x F _C
Maximum Response, Hz	=	0
All Other Emissions	=	= 20 dB Below Limit
Limit(s), dBc		
	12.5 kHz Channel	56.99 (-20dBm)
	6.25 kHz Channel	61.99 (-25dBm)

Tabulated Results follow:

Measurement Results

g05b0108: 2005-Nov-30 Wed 11:18:00
 STATE: 2:High Power 12.5kHz / 6.25kHz Channel Ambient Temperature: 23°C ± 3°C

Frequency Tuned, MHz	Frequency Emission, MHz	Level, dBm	Level, dBc	Margin, dB
----------------------	-------------------------	------------	------------	------------

All reading less than -45dBm (i.e. 20dB below worse-case limit)



Performed by: Fred Chastain, Test Technician

Name of Test: Field Strength of Spurious Radiation
Specification: 47 CFR 2.1053(a)
Guide: ANSI/TIA/EIA-603-1992/2001, Paragraph 1.2.12 and Table 16, 47 CFR 22.917

Measurement Procedure

Definition:
 Radiated spurious emissions are emissions from the equipment when transmitting into a non-radiating load on a frequency or frequencies which are outside an occupied band sufficient to ensure transmission of information of required quality for the class of communications desired.

Method of Measurement:

- A) Connect the equipment as illustrated
- B) Adjust the spectrum analyzer for the following settings:
 - 1) Resolution Bandwidth 100 kHz (<1 GHz), 1 MHz (> 1GHz).
 - 2) Video Bandwidth = 3 times Resolution Bandwidth, or 30 kHz (22.917)
 - 3) Sweep Speed ≤ 2000 Hz/second
 - 4) Detector Mode = Mean or Average Power
- C) Place the transmitter to be tested on the turntable in the standard test site. The transmitter is transmitting into a non-radiating load that is placed on the turntable. The RF cable to this load should be of minimum length.

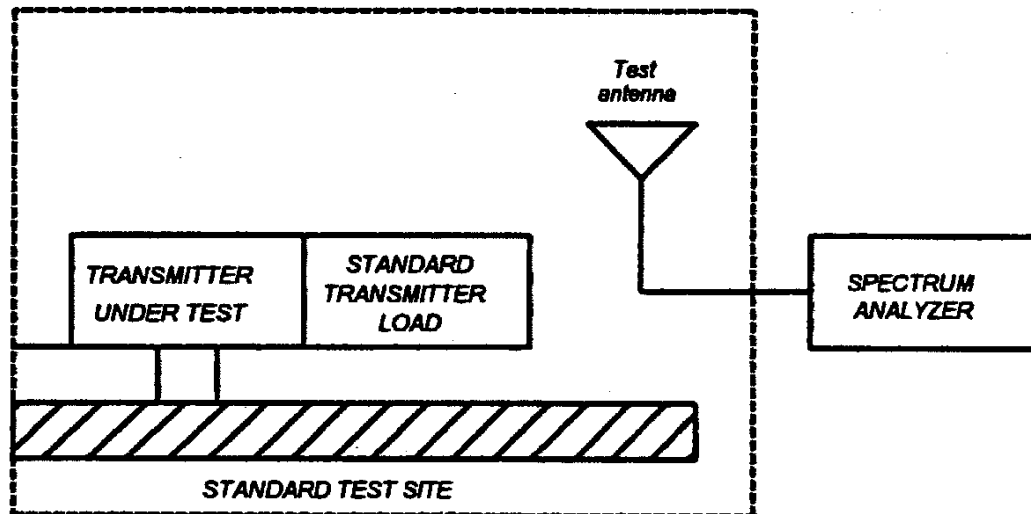

Name of Test: Field Strength of Spurious Radiation (Cont.)

- D) For each spurious measurement the test antenna should be adjusted to the correct length for the frequency involved. This length may be determined from a calibration ruler supplied with the equipment. Measurements shall be made from the lowest radio frequency generated in the equipment to the tenth harmonic of the carrier, except for the region close to the carrier equal to \pm the test bandwidth (see section 1.3.4.4).
- E) For each spurious frequency, raise and lower the test antenna from 1 m to 4 m to obtain a maximum reading on the spectrum analyzer with the test antenna at horizontal polarity. Repeat this procedure to obtain the highest possible reading. Record this maximum reading.
- F) Repeat step E) for each spurious frequency with the test antenna polarized vertically.

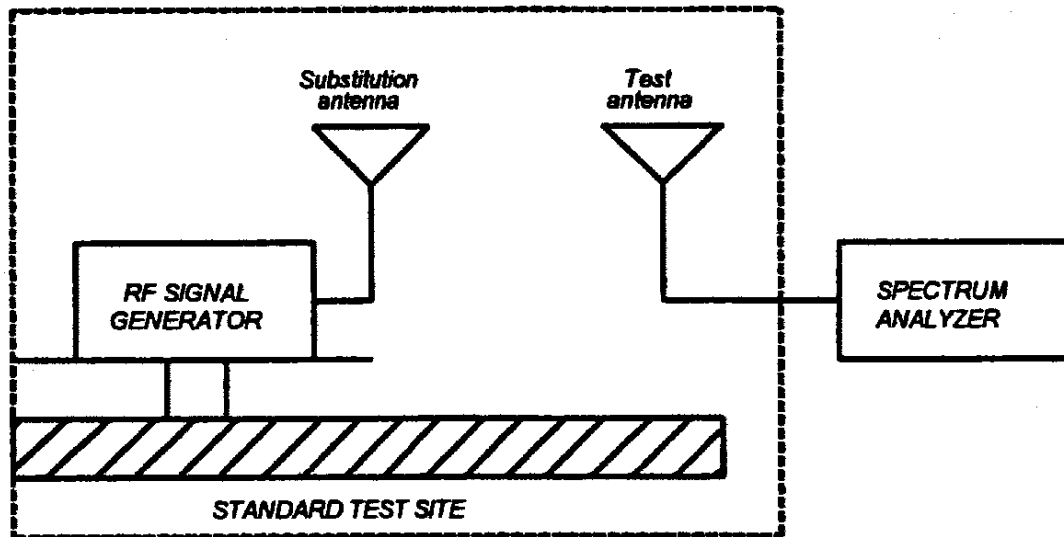

- G) Reconnect the equipment as illustrated.
- H) Keep the spectrum analyzer adjusted as in step B).
- I) Remove the transmitter and replace it with a substitution antenna (the antenna should be half-wavelength for each frequency involved). The center of the substitution antenna should be approximately at the same location as the center of the transmitter. At lower frequencies, where the substitution antenna is very long, this will be impossible to achieve when the antenna is polarized vertically. In such case the lower end of the antenna should be 0.3 m above the ground.

Name of Test: Field Strength of Spurious Radiation (Cont.)

- J) Feed the substitution antenna at the transmitter end with a signal generator connected to the antenna by means of a non-radiating cable. With the antennas at both ends horizontally polarized and with the signal generator tuned to a particular spurious frequency, raise and lower the test antenna to obtain a maximum reading at the spectrum analyzer. Adjust the level of the signal generator output until the previously recorded maximum reading for this set of conditions is obtained. This should be done carefully repeating the adjustment of the test antenna and generator output.
- K) Repeat step J) with both antennas vertically polarized for each spurious frequency.
- L) Calculate power in dBm into a reference ideal half-wave dipole antenna by reducing the readings obtained in steps J) and K) by the power loss in the cable between the generator and the antenna and further corrected for the gain of the substitution antenna used relative to an ideal half-wave dipole antenna.
- M) The levels recorded in step L) are absolute levels of radiated spurious emissions in dBm. The radiated spurious emissions in dB can be calculated by the following:

Radiated spurious emissions dB =

$$10\log_{10}(\text{TX power in watts}/0.001) - \text{the levels in step I)}$$

NOTE: It is permissible that other antennas provided can be referenced to a dipole.

Test Equipment

Asset	Description	s/n	Cycle	Last Cal
Transducer				
i00088	EMCO 3109-B 25MHz-300MHz	2336	24 mo.	Sep-05
X i00089	April 2001 200MHz-1GHz	001500	24 mo.	Sep-05
X i00103	EMCO 3115 1GHz-18GHz	9208-3925	24 mo.	Sep-05
Amplifier				
X i00028	HP 8449A	2749A00121	12 mo.	May-05
Spectrum Analyzer				
X i00029	HP 8563E	3213A00104	12 mo.	May-05
X i00033	HP 85462A	3625A00357	12 mo.	Sep-05
Substitution Generator				
X i00067	HP 8920A Communication TS	3345U01242	12 mo.	Jun-05
i00207	HP 8753D Network Analyzer	3410A08514	12 mo.	Jul-05

Microphone, Antenna Port, and Cabling

Microphone	<u>Yes</u>	Cable Length	<u>1.0</u>	Meters
Antenna Port Terminated	<u>Yes</u>	Load	<u>-</u>	Antenna Gain
All Ports Terminated by Load	<u>Yes</u>	Peripheral	<u>-</u>	<u>0dBi</u>

Name of Test: Field Strength of Spurious Radiation

Measurement Results

Worse-Case

g05b0110: 2005-Nov-30 Wed 13:10:00

STATE: 2:High Power / 12.5kHz Channel

Ambient Temperature: 23°C ± 3°C

Frequency Tuned, MHz	Frequency Emission, MHz	ERP, dBm	ERP, dBc
450.050000	900.113000	-28.6	-65.5
467.050000	934.113000	-25.7	-62.6
485.050000	970.130000	-26.1	-63.0
450.050000	1350.150000	-32.1	-69.0
467.050000	1401.150000	-32.0	-68.9
485.050000	1455.150000	-33.5	-70.4
450.050000	1800.200000	-29.5	-66.4
467.050000	1868.200000	-28.3	-65.2
485.050000	1940.200000	-29.0	-65.9
450.050000	2250.250000	-27.8	-64.7
467.050000	2335.250000	-22.7	-59.6
485.050000	2425.250000	-24.8	-61.7
450.050000	2700.300000	-27.7	-64.6
467.050000	2802.300000	-25.0	-61.9
485.050000	2910.300000	-26.8	-63.7
450.050000	3150.350000	-25.4	-62.3
467.050000	3269.350000	-24.8	-61.7
485.050000	3395.350000	-23.3	-60.2
450.050000	3600.400000	-25.3	-62.2
467.050000	3736.400000	-21.0	-57.9
485.050000	3880.400000	-21.4	-58.3
450.050000	4050.450000	-22.4	-59.3
467.050000	4203.450000	-22.6	-59.5
485.050000	4365.450000	-20.1	-57.0
450.050000	4500.500000	-21.9	-58.8
467.050000	4670.500000	-22.9	-59.8
485.050000	4850.500000	-24.4	-61.3



Performed by:

Fred Chastain, Test Technician

Name of Test: Emission Masks (Occupied Bandwidth)
Specification: 47 CFR 2.1049(c)(1)
Guide: ANSI/TIA/EIA-603-1992, Paragraph 2.2.11

Measurement Procedure

- A) The EUT and test equipment were set up as shown below
- B) For EUTs supporting audio modulation, the audio signal generator was adjusted to the frequency of maximum response and with output level set for $\pm 2.5/\pm 1.25$ kHz deviation (or 50% modulation). With level constant, the signal level was increased 16 dB.
- C) For EUTs supporting digital modulation, the digital modulation mode was operated to its maximum extent.
- D) The Occupied Bandwidth was measured with the Spectrum Analyzer controls set as shown on the test results.

Transmitter Test Set-Up: Occupied Bandwidth

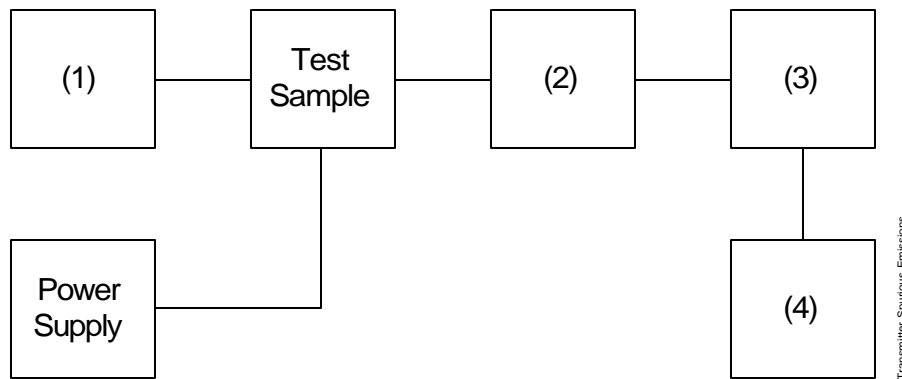

Asset	Description	s/n	Cycle	Last Cal
(1) Audio Oscillator/Generator				
X i00017	HP 8903A Modulation Meter	2216A01753	12 mo.	Apr-05
(2) Coaxial Attenuator				
X i00231/2	PASTERNAK PE7021-30 (30 dB)	231 or 232	NCR	
i00123	NARDA 766 (10 dB)	7802A	NCR	
(3) Interface				
X i00021	HP 8954A Transceiver Interface	2146A00159	NCR	
(4) Spectrum Analyzer				
X i00048	HP 8566B Spectrum Analyzer	2511A01467	12 mo.	Oct-05
i00029	HP 8563E Spectrum Analyzer	3213A00104	12 mo.	May-05

Name of Test: Emission Masks (Occupied Bandwidth)

Measurement Results

g05c0014: 2005-Dec-08 Thu 14:22:00
State: 1:Low Power

Ambient Temperature: 23°C ± 3°C

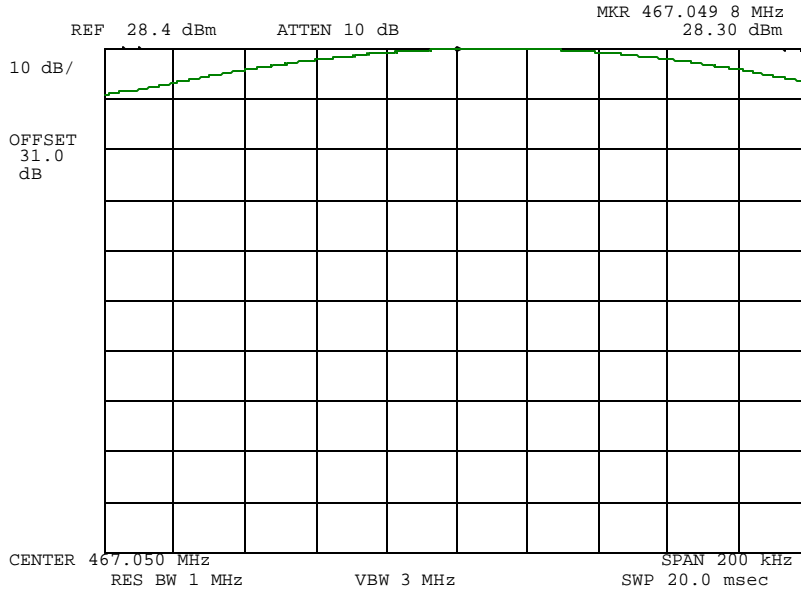

Power:
Modulation:

LOW
POWER MID CHANNEL
-

Performed by:

Fred Chastain, Test Technician

Name of Test: Emission Masks (Occupied Bandwidth)

Measurement Results

g05c0015: 2005-Dec-08 Thu 14:25:00
State: 1:Low Power

Ambient Temperature: 23°C ± 3°C

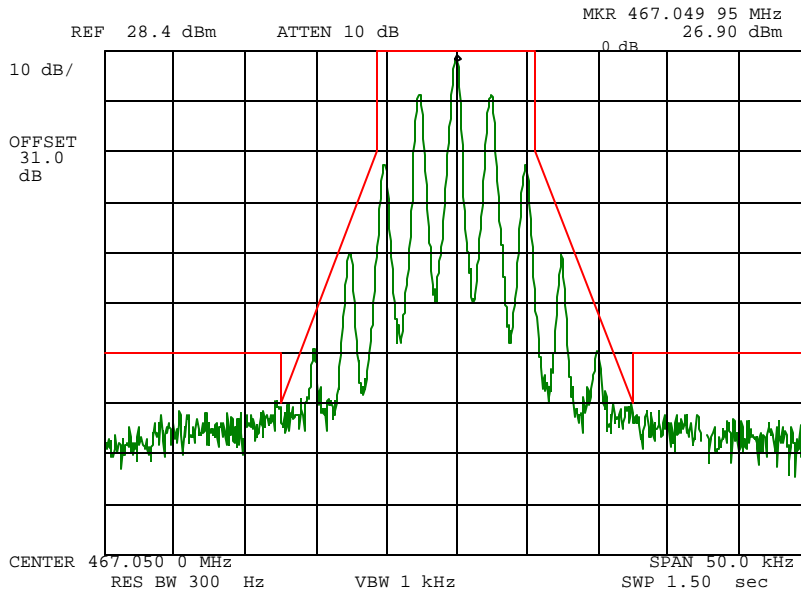

Power:
Modulation:

LOW
VOICE: 2500 Hz SINE WAVE (MASK D)
12.5KHZ MID CHANNEL

Fred Chastain

Performed by:

Fred Chastain, Test Technician

Name of Test: Emission Masks (Occupied Bandwidth)

Measurement Results

g05c0016: 2005-Dec-08 Thu 14:26:00
State: 1:Low Power

Ambient Temperature: 23°C ± 3°C

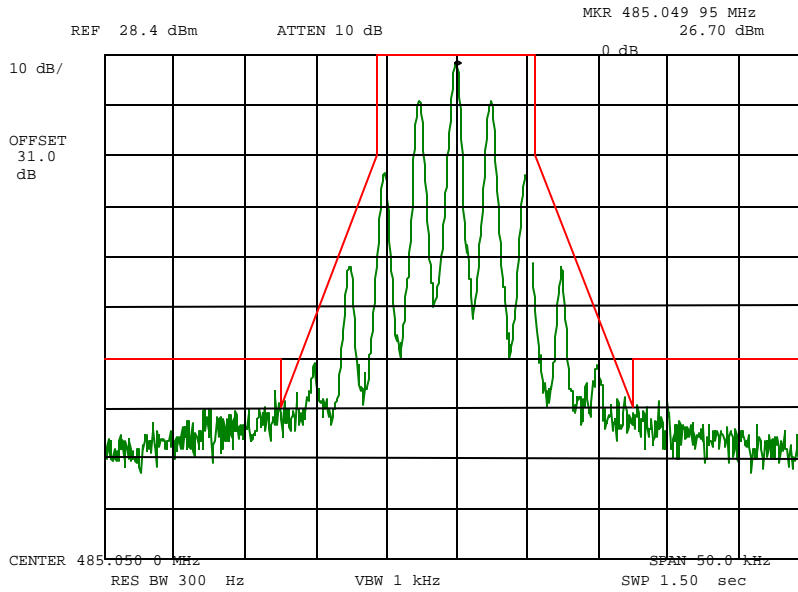

Power:
Modulation:

LOW
VOICE: 2500 Hz SINE WAVE (MASK D)
12.5KHZ HI CHANNEL

Fred Chastain

Performed by:

Fred Chastain, Test Technician

Name of Test: Emission Masks (Occupied Bandwidth)

Measurement Results

g05c0017: 2005-Dec-08 Thu 14:27:00
State: 1:Low Power

Ambient Temperature: 23°C ± 3°C

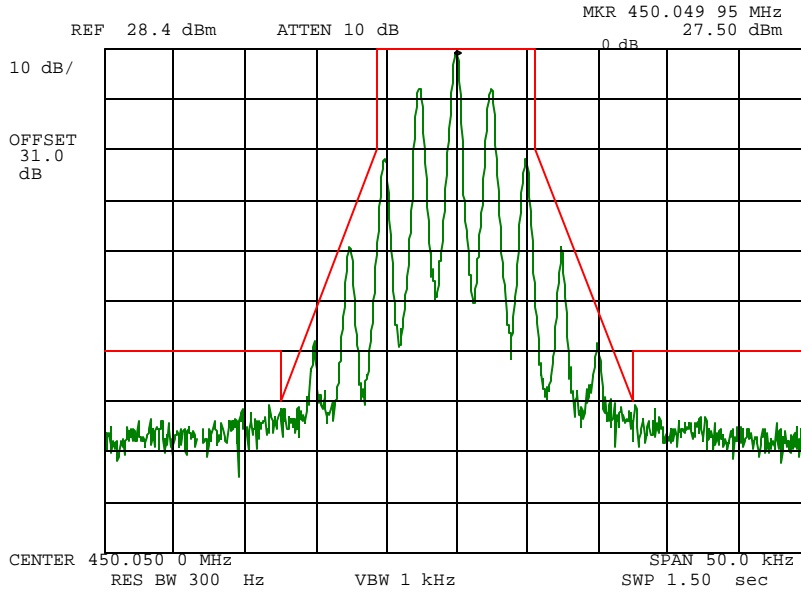

Power:
Modulation:

LOW
VOICE: 2500 Hz SINE WAVE (MASK D)
12.5KHZ LO CHANNEL

Fred Chastain

Performed by:

Fred Chastain, Test Technician

Name of Test: Emission Masks (Occupied Bandwidth)

Measurement Results

g05c0018: 2005-Dec-08 Thu 14:28:00
State: 1:Low Power

Ambient Temperature: 23°C ± 3°C

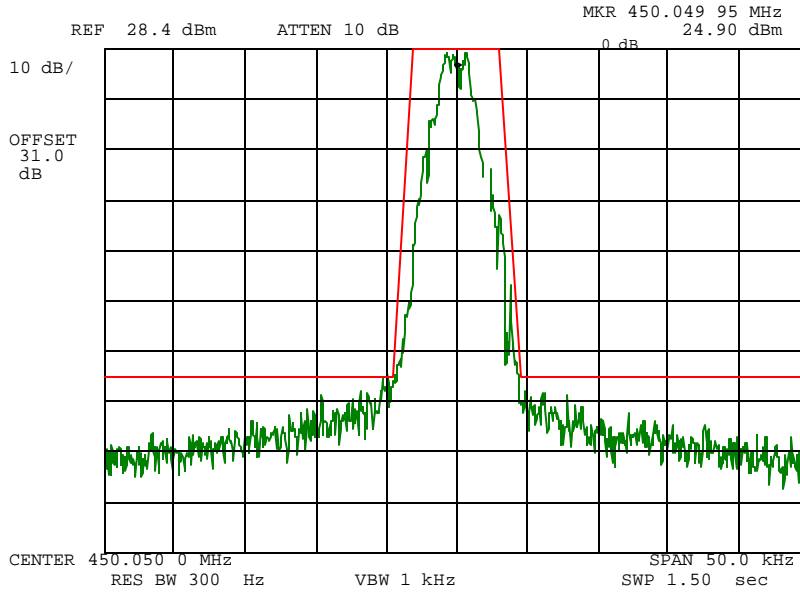

Power:
Modulation:

LOW
ENCRYPTED VOICE / DATA (MASK E)
6.25KHZ LO CHANNEL

Fred Chastain

Performed by:

Fred Chastain, Test Technician

Name of Test: Emission Masks (Occupied Bandwidth)

Measurement Results

g05c0019: 2005-Dec-08 Thu 14:33:00
State: 1:Low Power

Ambient Temperature: 23°C ± 3°C

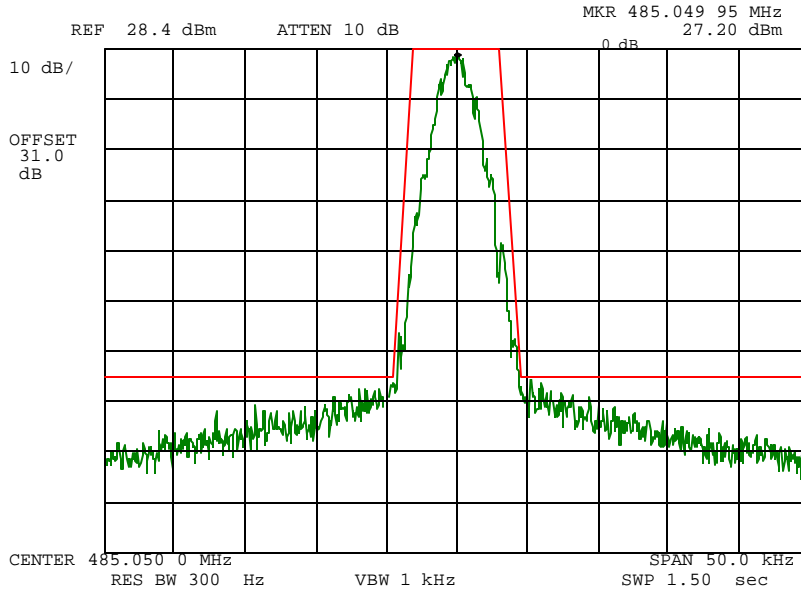

Power:
Modulation:

LOW
ENCRYPTED VOICE / DATA (MASK E)
6.25KHZ HI CHANNEL

Fred Chastain

Performed by:

Fred Chastain, Test Technician

Name of Test: Emission Masks (Occupied Bandwidth)

Measurement Results

g05c0020: 2005-Dec-08 Thu 14:34:00
State: 1:Low Power

Ambient Temperature: 23°C ± 3°C

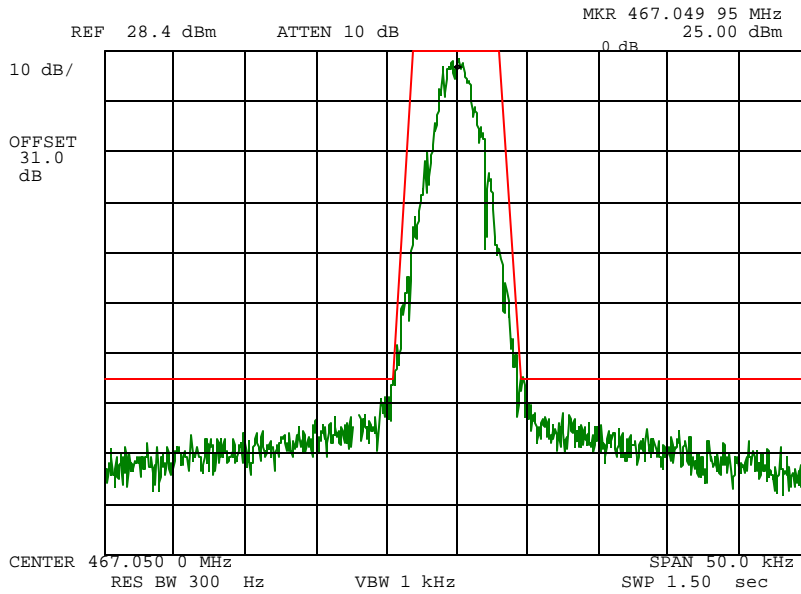

Power:
Modulation:

LOW
ENCRYPTED VOICE / DATA (MASK E)
6.25KHZ MID CHANNEL

Fred Chastain

Performed by:

Fred Chastain, Test Technician

Name of Test: Emission Masks (Occupied Bandwidth)

Measurement Results

g05c0006: 2005-Dec-08 Thu 14:03:00
State: 2:High Power

Ambient Temperature: 23°C ± 3°C

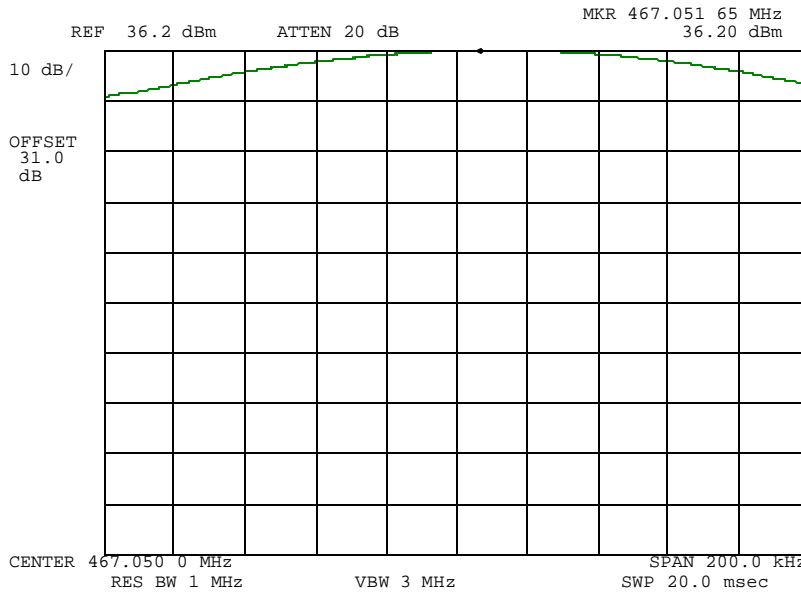

Power:
Modulation:

HIGH
POWER MID CHANNEL

Fred Chastain

Performed by:

Fred Chastain, Test Technician

Name of Test: Emission Masks (Occupied Bandwidth)

Measurement Results

g05c0007: 2005-Dec-08 Thu 14:09:00
State: 2:High Power

Ambient Temperature: 23°C ± 3°C

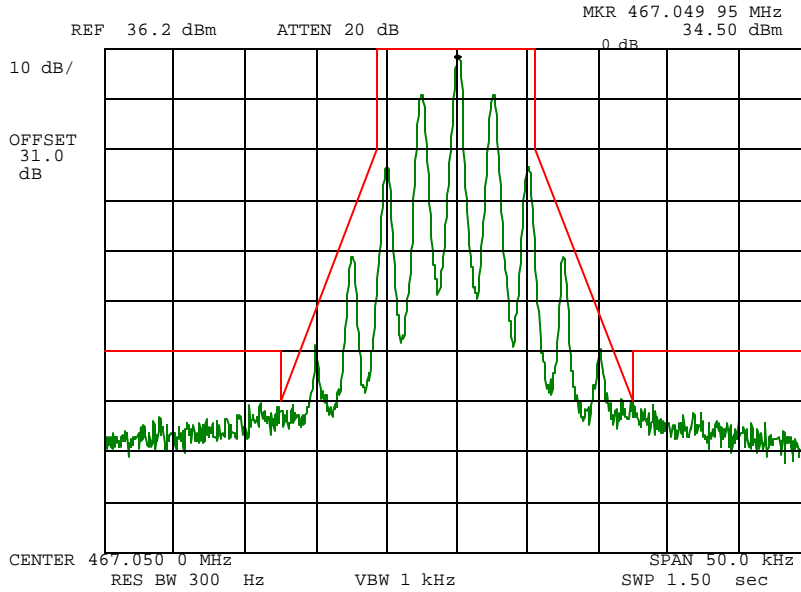

Power:
Modulation:

HIGH
VOICE: 2500 Hz SINE WAVE (MASK D)
12.5KHZ MID CHANNEL

Fred Chastain

Performed by:

Fred Chastain, Test Technician

Name of Test: Emission Masks (Occupied Bandwidth)

Measurement Results

g05c0008: 2005-Dec-08 Thu 14:10:00
State: 2:High Power

Ambient Temperature: 23°C ± 3°C

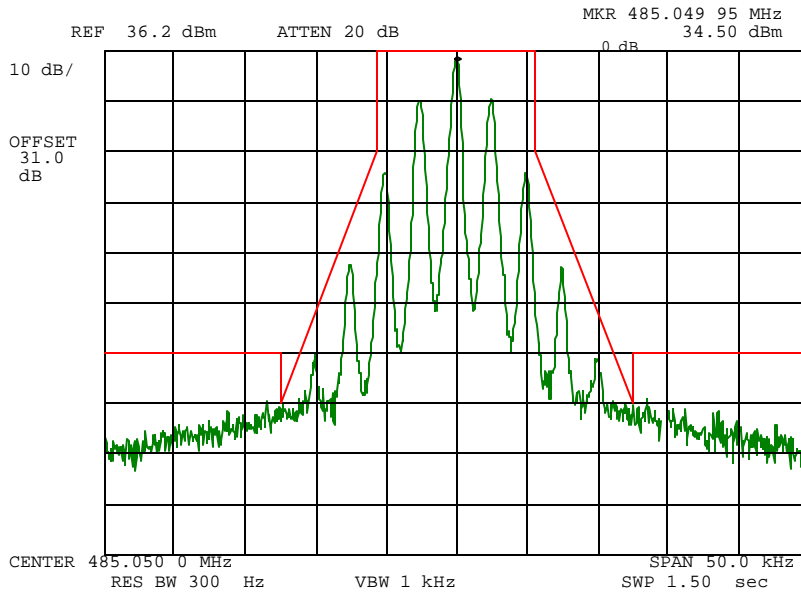

Power:
Modulation:

HIGH
VOICE: 2500 Hz SINE WAVE (MASK D)
12.5KHZ HI CHANNEL

Fred Chastain

Performed by:

Fred Chastain, Test Technician

Name of Test: Emission Masks (Occupied Bandwidth)

Measurement Results

g05c0009: 2005-Dec-08 Thu 14:12:00
State: 2:High Power

Ambient Temperature: 23°C ± 3°C

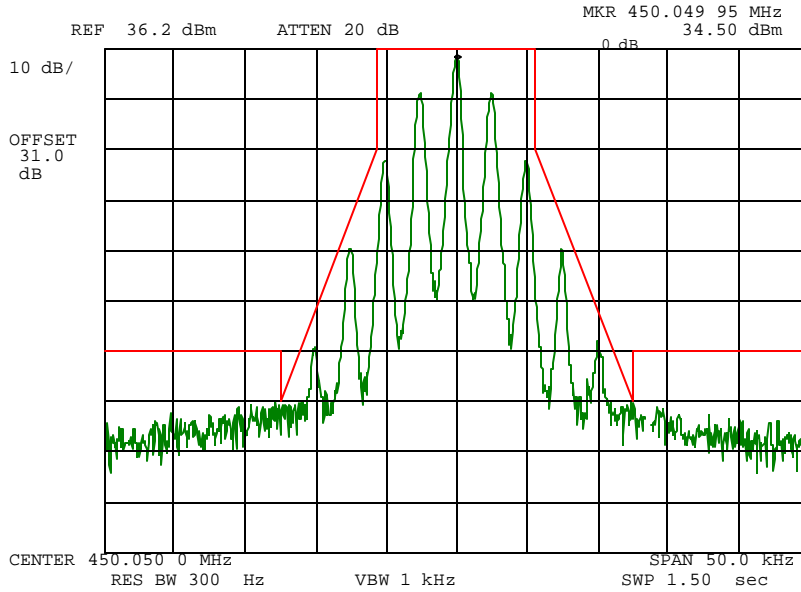

Power:
Modulation:

HIGH
VOICE: 2500 Hz SINE WAVE (MASK D)
12.5KHZ LO CHANNEL

Fred Chastain

Performed by:

Fred Chastain, Test Technician

Name of Test: Emission Masks (Occupied Bandwidth)

Measurement Results

g05c0011: 2005-Dec-08 Thu 14:16:00
 State: 2:High Power

Ambient Temperature: 23°C ± 3°C

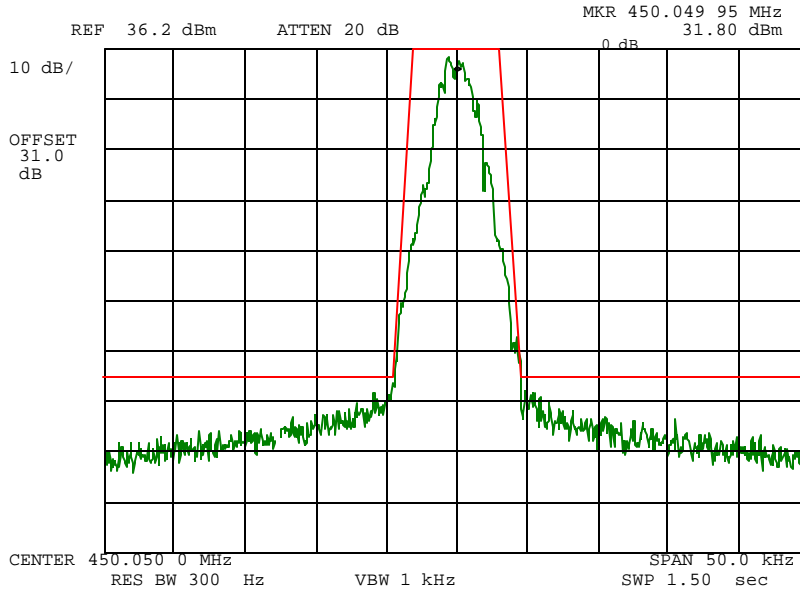

Power:
 Modulation:

HIGH
 ENCRYPTED VOICE / DATA (MASK E)
 6.25KHZ LO CHANNEL

Fred Chastain

Performed by:

Fred Chastain, Test Technician

Name of Test: Emission Masks (Occupied Bandwidth)

Measurement Results

g05c0012: 2005-Dec-08 Thu 14:18:00
State: 2:High Power

Ambient Temperature: 23°C ± 3°C

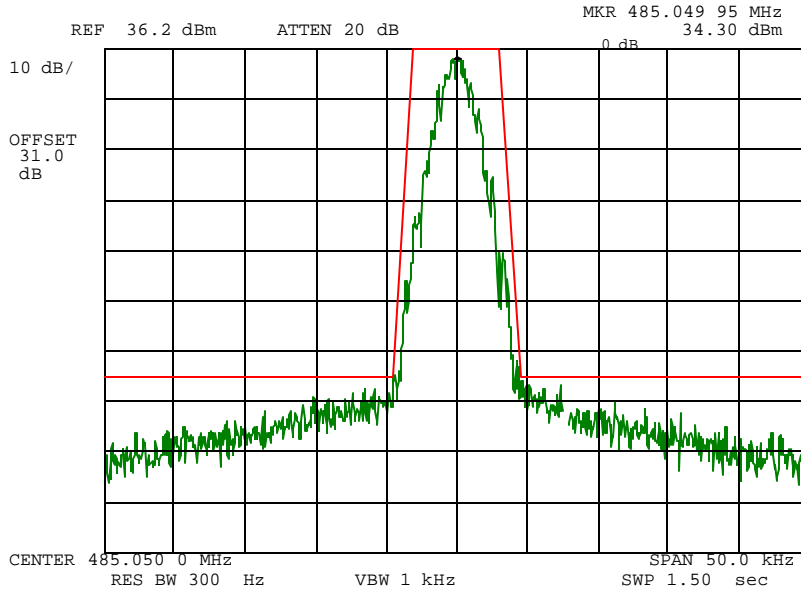

Power:
Modulation:

HIGH
ENCRYPTED VOICE / DATA (MASK E)
6.25KHZ HI CHANNEL

Fred Chastain

Performed by:

Fred Chastain, Test Technician

Name of Test: Emission Masks (Occupied Bandwidth)

Measurement Results

g05c0013: 2005-Dec-08 Thu 14:19:00
State: 2:High Power

Ambient Temperature: 23°C ± 3°C

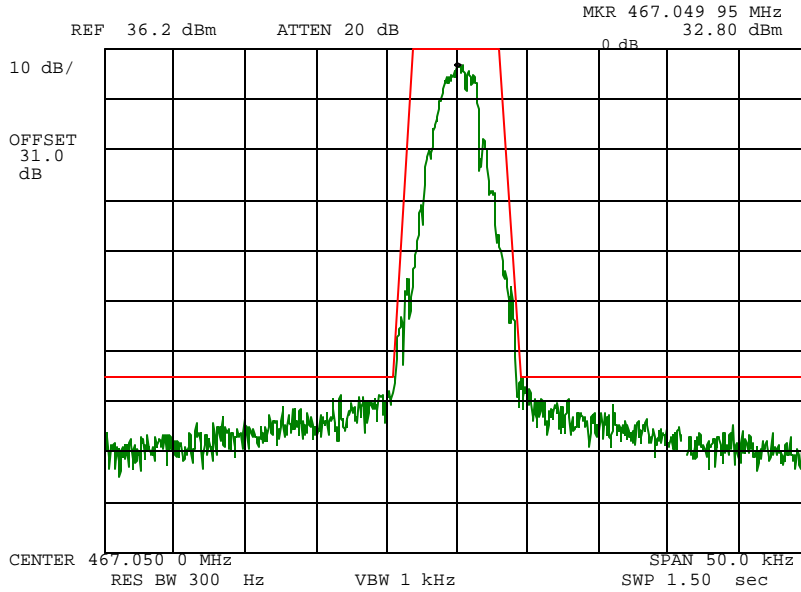

Power:
Modulation:

HIGH
ENCRYPTED VOICE / DATA (MASK E)
6.25KHZ MID CHANNEL

Fred Chastain

Performed by:

Fred Chastain, Test Technician

Name of Test: Transient Frequency Behavior
Specification: 47 CFR 90.214
Guide: ANSI/TIA/EIA-603-1992, Paragraph 2.2.19

Measurement Procedure

- A) The EUT was setup as shown on the attached page, following TIA/EIA-603 steps a, b, and c as a *guide*.
- B) The transmitter was turned on.
- C) Sufficient attenuation was provided so that the transmitter carrier level measured at the output of the combiner was 40 dB below the maximum input level of the test receiver. This level was recorded.
- D) The transmitter was turned off.
- E) An RF signal generator (1) modulated with a 1 kHz tone at either 25, 12.5, or 6.25 kHz deviation, and set to the same frequency as the assigned transmitter frequency, (2) was adjusted to a level -20 dB below the level recorded for step C) above, measured at the output of the combiner. This level was then fixed for the remainder of the test.
- F) The oscilloscope was setup using TIA/EIA-603 steps j and k as a guide, and to either 10 ms/div (UHF) or 5 ms/div (VHF).
- G) The 30 dB attenuator was removed, the transmitter was turned on, and the level of the carrier at the output of the combiner was recorded.
- H) The carrier on-time as referenced in TIA/EIA-603 steps m, n, and o was captured and plotted. The carrier off-time as referenced in TIA/EIA-603 steps p, q, r, and s was captured and plotted.



Performed by:

Fred Chastain, Test Technician

Name of Test: Transient Frequency Behavior

Transmitter Set-Up

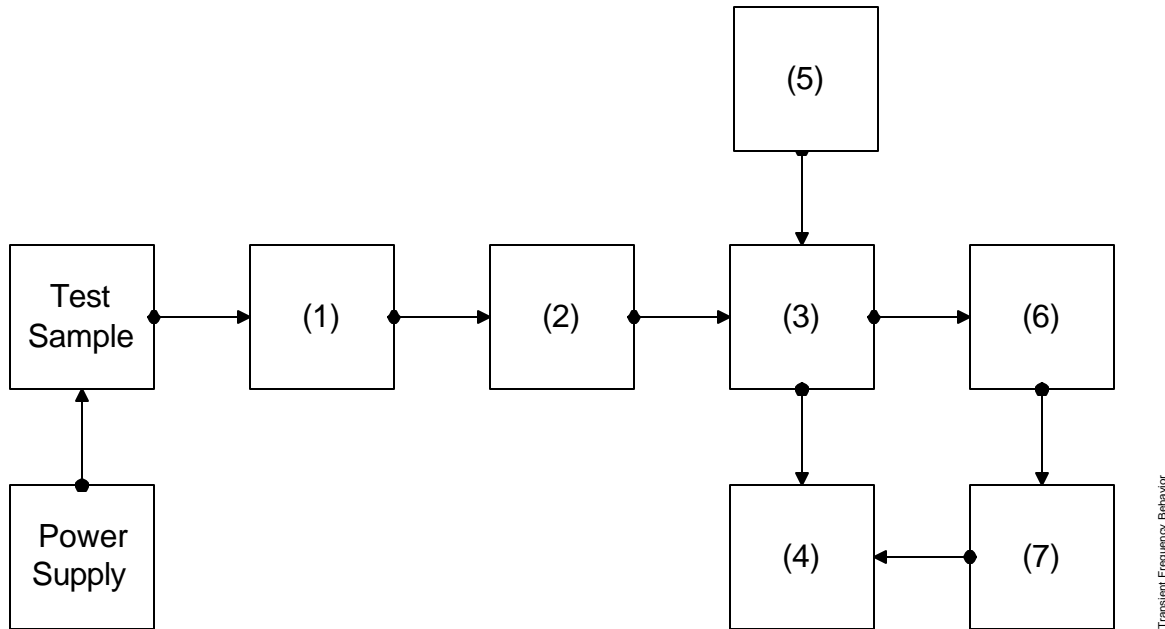

Asset	Description	s/n	Cycle	Last Cal
(1) Attenuator	(Removed after 1st step)			
X i00231/2	PASTERNAK PE7021-30 (30 dB)	231 or 232	NCR	
(2) Attenuator				
X i00231/2	PASTERNAK PE7021-30 (30 dB)	231 or 232	NCR	
i00122/3	NARDA 766 (10 dB)	7802 or 7802A	NCR	
(3) Combiner				
X i00154	4 x 25 Ω Combiner	154	NCR	
(4) Crystal Decoder				
X i00159	HP 8470B Crystal Detector	1822A10054	NCR	
(5) RF Signal Generator				
X i00067	HP 8920A Communication TS	3345U01242	12 mo.	Jun-05
(6) Modulation Analyzer				
X i00020	HP 8901A Modulation Meter	2105A01087	12 mo.	Apr-05
(7) Oscilloscope				
X i00030	HP 54502A Digital Oscilloscope	2927A00209	12 mo.	Jan-05

The above equipment used in the verification of Applicant supplied plots.

Name of Test: Transient Frequency Behavior

State: General

Ambient Temperature: 23°C ± 3°C

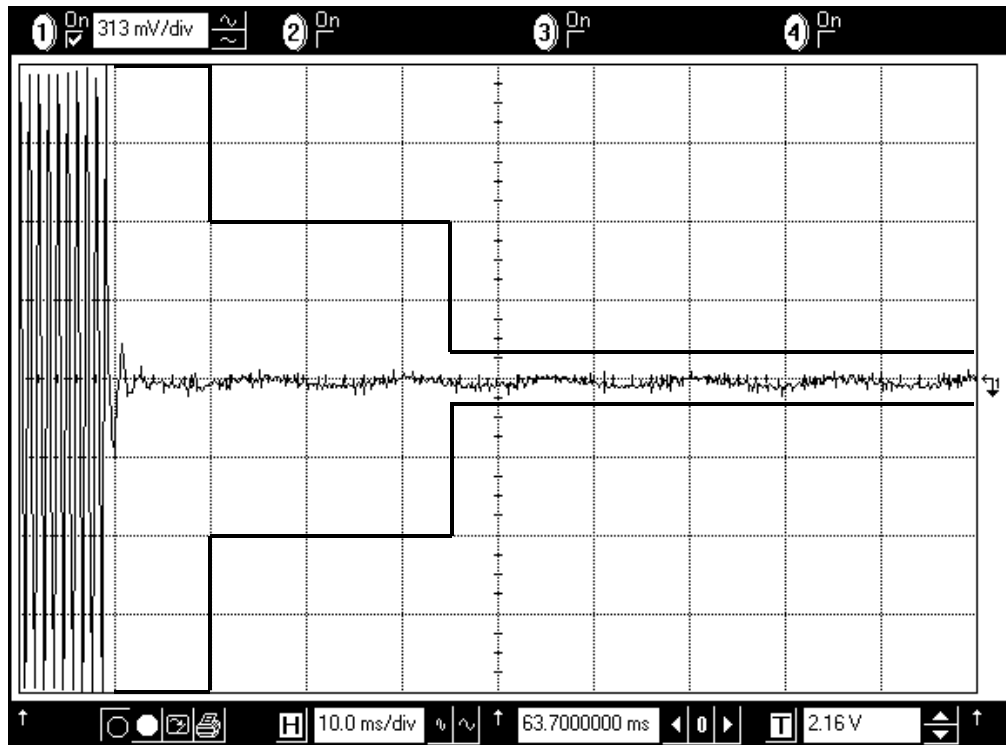

Power:
Modulation:
Description:

High
12.5kHz
TX - On

Verified by:

David E. Lee, FCC Compliance Manager

Name of Test: Transient Frequency Behavior

State: General

Ambient Temperature: 23°C ± 3°C

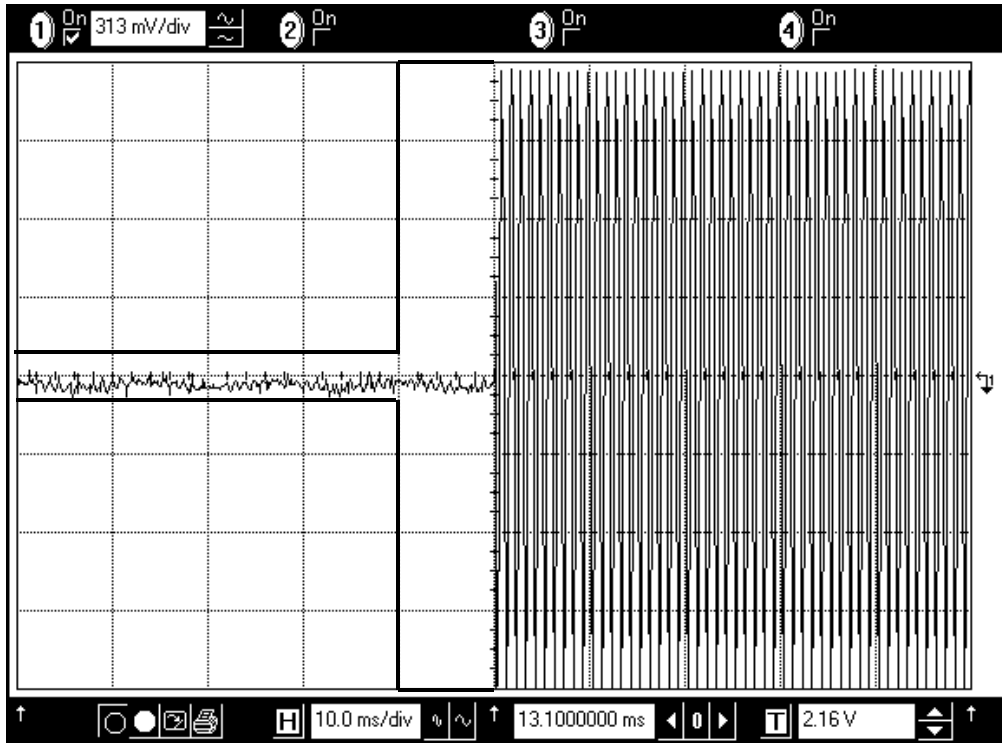

Power:
Modulation:
Description:

High
12.5kHz
TX - Off

Verified by:

David E. Lee, FCC Compliance Manager

Name of Test: Transient Frequency Behavior

State: General

Ambient Temperature: 23°C ± 3°C

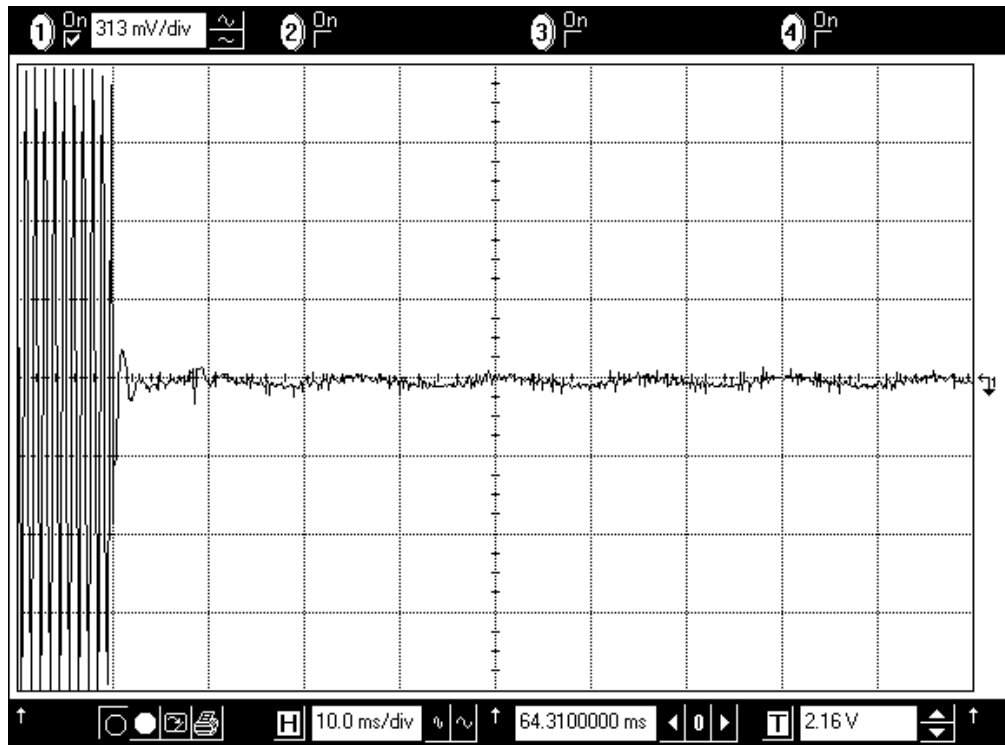

Power:
Modulation:
Description:

Low
12.5kHz
TX - On

Verified by:

David E. Lee, FCC Compliance Manager

Name of Test: Transient Frequency Behavior

State: General

Ambient Temperature: 23°C ± 3°C

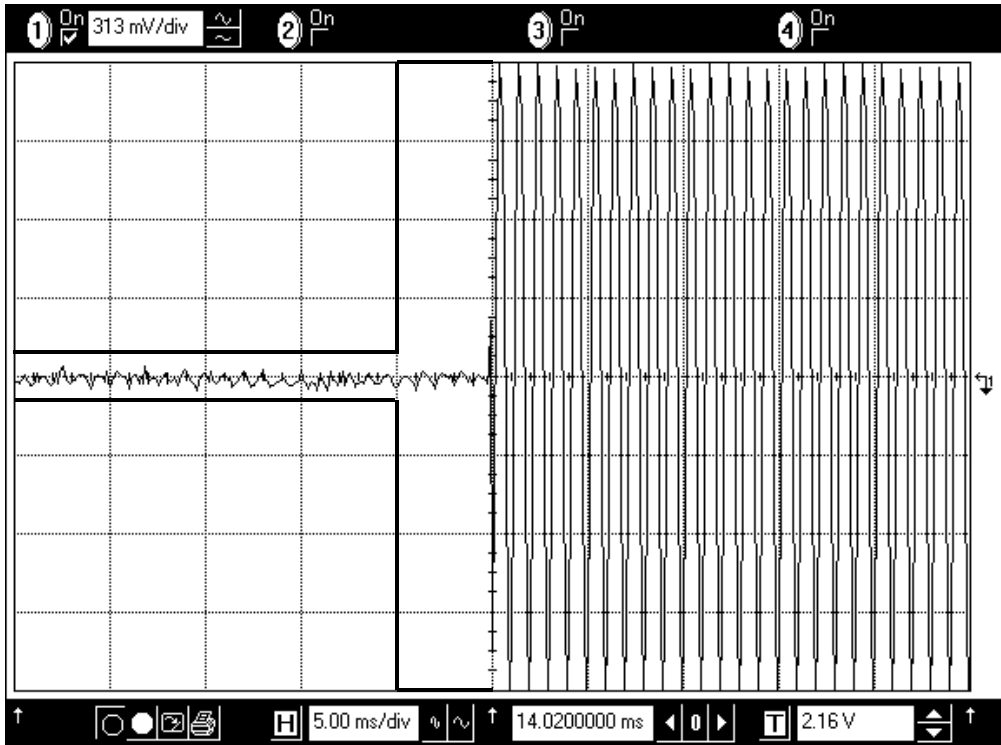

Power:
Modulation:
Description:

Low
12.5kHz
TX - Off

Verified by:

David E. Lee, FCC Compliance Manager

Name of Test: Audio Low Pass Filter (Voice Input)
Specification: 47 CFR 2.1047(a)
Guide: ANSI/TIA/EIA-603-1992, Paragraph 2.2.15

Measurement Procedure

- A) The EUT and test equipment were set up such that the audio input was connected at the input to the modulation limiter, and the modulated stage.
- B) The audio output was connected at the output to the modulated stage.

Transmitter Test Set-Up: Response of Low Pass Filter

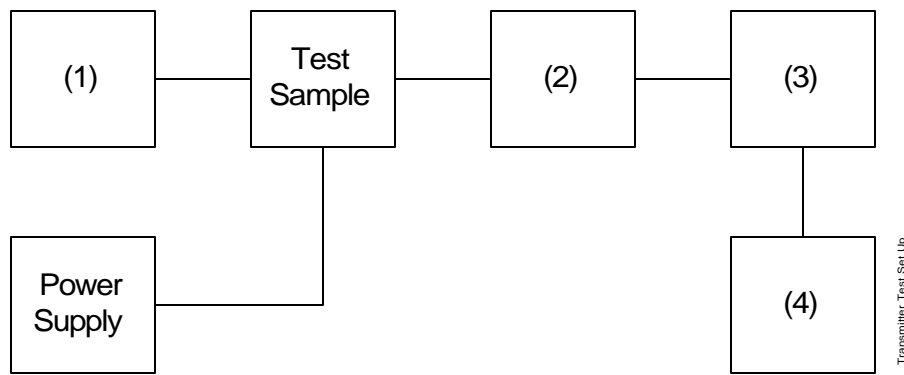

Asset	Description	s/n	Cycle	Last Cal
(1) Audio Oscillator				
X i00002	HP 3336B Synthesizer / Level Gen.	1931A01465	12 mo	Apr-05
(2) Coaxial Attenuator				
i00122/3	NARDA 766 (10dB)10	7802 or 7802A	NCR	
X i00231/2	PASTERNAK PE7021-30 (30 dB)	231 or 232	NCR	
(3) Modulation Analyzer				
X i00020	HP 8901A Modulation Meter	2105A01087	12 mo.	Apr-05
(4) Audio Analyzer				
X i00001	HP 3586B Selective Level Meter	1928A01360	12 mo.	Apr-05

Name of Test: Audio Low Pass Filter (Voice Input)

Measurement Results

g05c0027: 2005-Dec-08 Thu 15:32:00
State: 0: 12.5kHz Voice

Ambient Temperature: 23°C ± 3°C

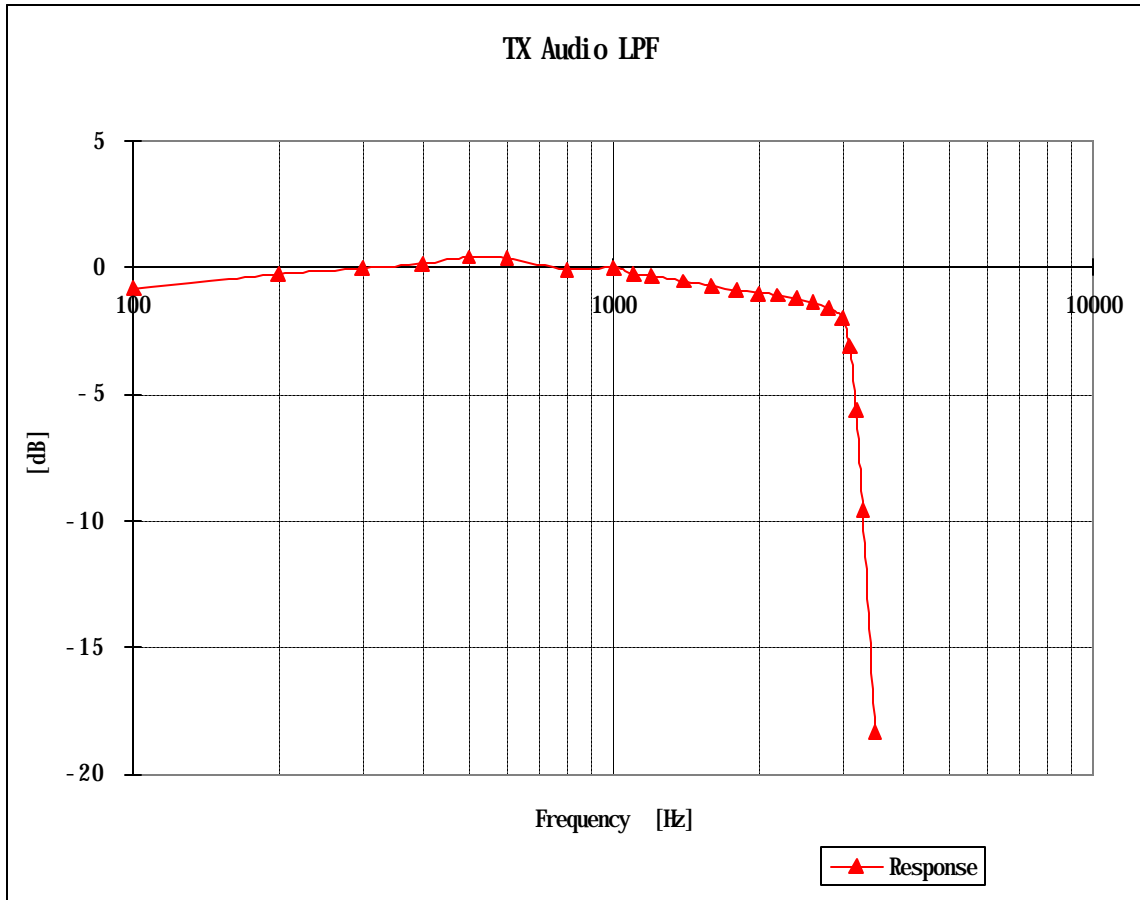

Applicant Supplied Plot

Verified by:

David E. Lee, FCC Compliance Manager

Name of Test: Audio Frequency Response
Specification: 47 CFR 2.1047(a)
Guide: ANSI/TIA/EIA-603-1992, Paragraph 2.2.6

Measurement Procedure

- A) The EUT and test equipment were set up as shown below.
- B) The audio signal generator was connected to the audio input circuit/microphone of the EUT.
- C) The audio signal input was adjusted to obtain 20% modulation at 1 kHz, and this point was taken as the 0 dB reference level.
- D) With input levels held constant and below limiting at all frequencies, the audio signal generator was varied from 100 Hz to 50 kHz.
- E) The response in dB relative to 1 kHz was measured, using the HP 8901A Modulation Meter.

Transmitter Test Set-Up: Audio Frequency Response

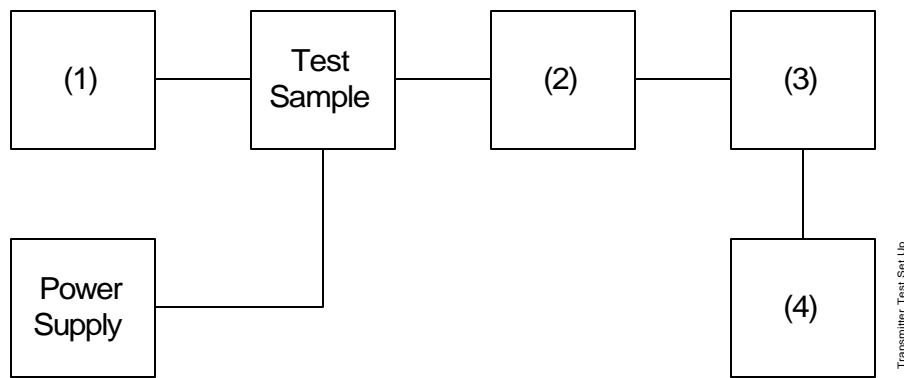

Asset	Description	s/n	Cycle	Last Cal
(1) Audio Oscillator				
X i00017	HP 8903A Audio Analyzer	2216A01753	12 mo.	Apr-05
(2) Coaxial Attenuator				
i00122/3	NARDA 766-(10 dB)	7802 or 7802A	NCR	
X i00231/2	PASTERNAK PE7021-30 (30 dB)	231 or 232	NCR	
(3) Modulation Analyzer				
X i00020	HP 8901A Modulation Meter	2105A01087	12 mo.	Apr-05
(4) Audio Analyzer				
X i00017	HP 8903A Audio Analyzer	2216A01753	12 mo.	Apr-05

Name of Test: Audio Frequency Response

Measurement Results

g05c0025: 2005-Dec-08 Thu 15:28:00
State: 0:General

Ambient Temperature: 23°C ± 3°C

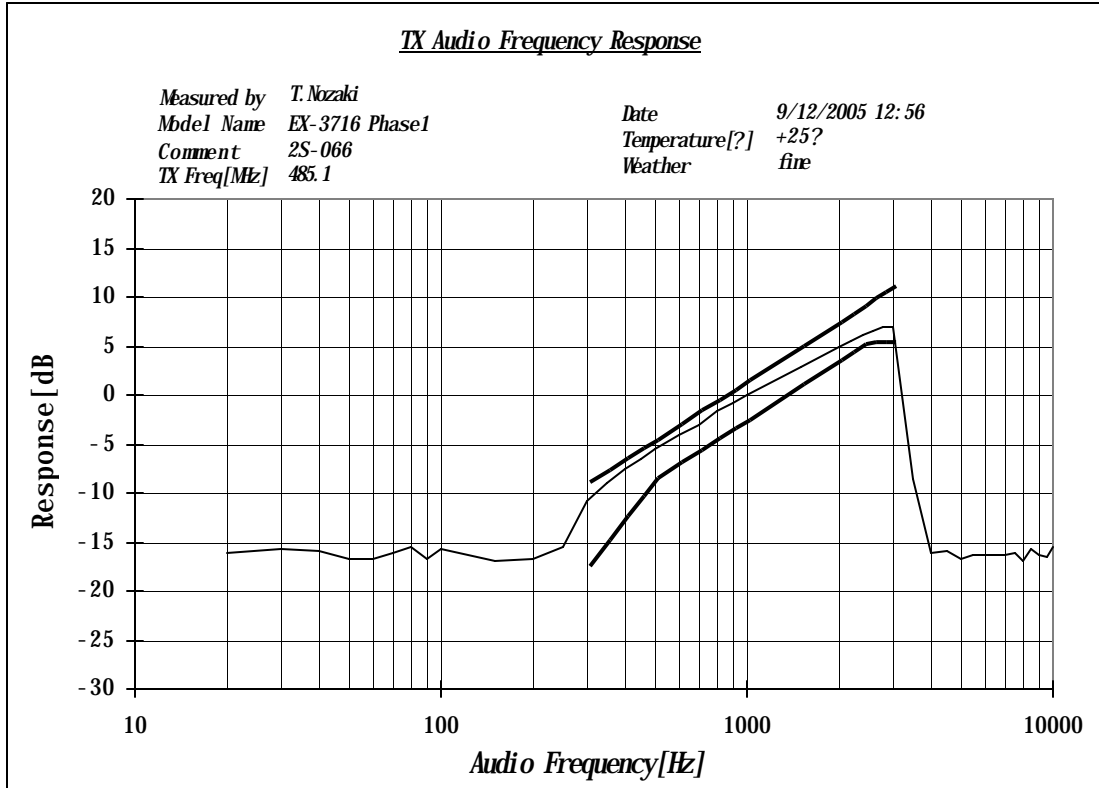

Applicant Supplied Plot

Frequency of Maximum Audio Response, Hz = 3000

Additional points:

Frequency, Hz	Level, dB
300	-10.79
20000	-16.41

Verified by:

David E. Lee, FCC Compliance Manager

Name of Test: Modulation Limiting
Specification: 47 CFR 2.1047(b)
Guide: ANSI/TIA/EIA-603-1992, Paragraph 2.2.3

Measurement Procedure

- A) The signal generator was connected to the input of the EUT as shown below.
- B) The modulation response was measured for each of three frequencies (one of which was the frequency of maximum response), and the input voltage was varied and was observed on an HP 8901A Modulation Analyzer.
- C) The input level was varied from 30% modulation (± 1.5 kHz deviation) to at least 20 dB higher than the saturation point.
- D) Measurements were performed for both negative and positive modulation and the respective results were recorded.

Transmitter Test Set-Up: Modulation Limiting

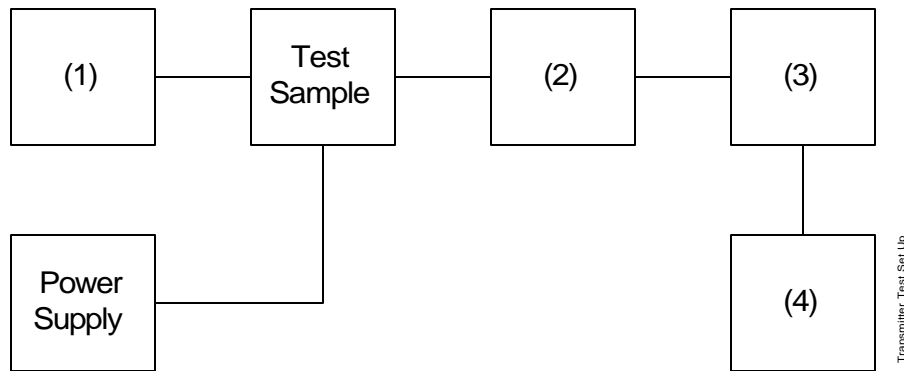

Asset	Description	s/n		
(1) Audio Oscillator				
X i00017	HP 8903A Audio Analyzer	2216A01753	12 mo.	Apr-04
(2) Coaxial Attenuator				
i0012/23	NARDA 766-(10 dB)	7802 or 7802A	NCR	
X i00231/2	PASTERNAK PE7021-30 (30 dB)	231 or 232	NCR	
(3) Modulation Analyzer				
X i00020	HP 8901A Modulation Meter	2105A01087	12 mo.	Apr-05
(4) Audio Analyzer				
X i00017	HP 8903A Audio Analyzer	2216A01753	12 mo.	Apr-05

Name of Test: Modulation Limiting

Measurement Results

g05c0023: 2005-Dec-08 Thu 15:19:00
State: 0: 12.5kHz Voice

Ambient Temperature: 23°C ± 3°C

Positive
Peaks:

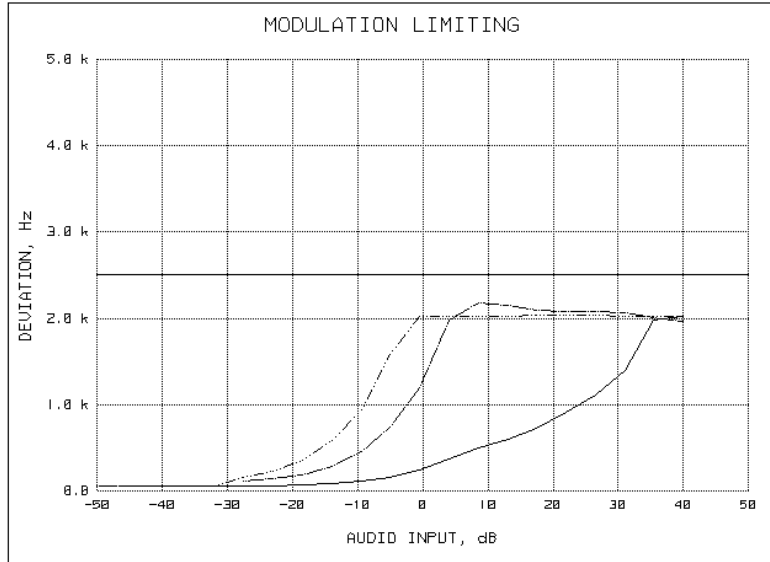

Negative
Peaks:

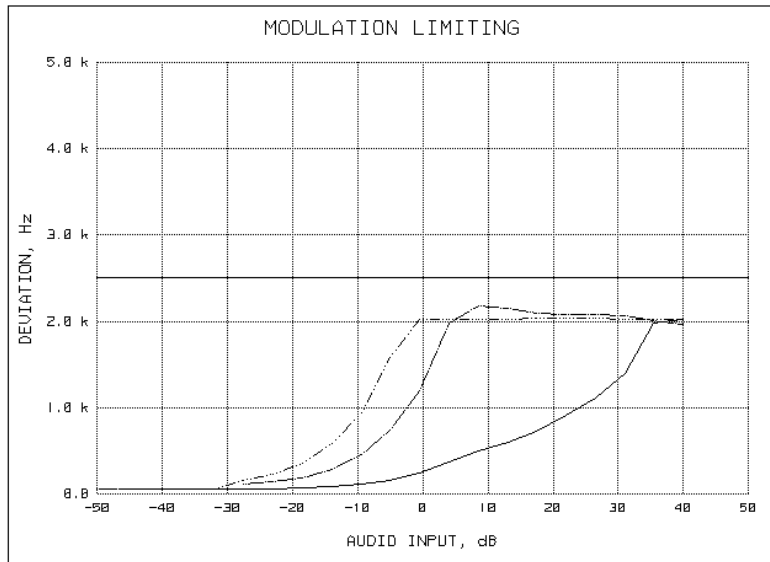

Fred Chastain

Performed by:

Fred Chastain, Test Technician

Name of Test: Frequency Stability (Temperature Variation)

Specification: 47 CFR 2.1055(a)(1)

Guide: ANSI/TIA/EIA-603-1992, Paragraph 2.2.2

Measurement Procedure

- A) The EUT and test equipment were set up as shown on the following page.
- B) With all power removed, the temperature was decreased to -30°C and permitted to stabilize for three hours. Power was applied and the maximum change in frequency was noted within one minute.
- C) With power OFF, the temperature was raised in 10°C steps. The sample was permitted to stabilize at each step for at least one-half hour. Power was applied and the maximum frequency change was noted within one minute.
- D) The temperature tests were performed for the worst case.

Transmitter Test Set-Up: Temperature Variation

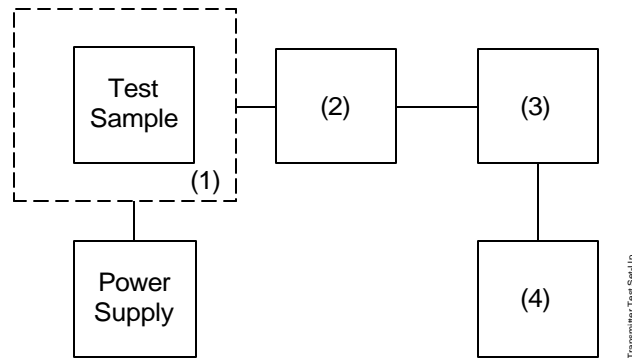

Asset	Description	s/n	Cycle	Last Cal
(1) Temperature, Humidity, Vibration				
X i00027	Tenney Temp. Chamber	9083-765-234	NCR	
(2) Coaxial Attenuator				
X i00231/2	PASTERNAK PE7021-30 (30 dB)	231 or 232	NCR	
i00122/3	NARDA 766 (10 dB)	7802 or 7802A	NCR	
(3) RF Power				
X i00067	HP 8920A Communications TS	3345U01242	12 mo.	Jun-04
(4) Frequency Counter				
X i00067	HP 8920A Communications TS	3345U01242	12 mo.	Jun-04

Name of Test: Frequency Stability (Temperature Variation)

Measurement Results

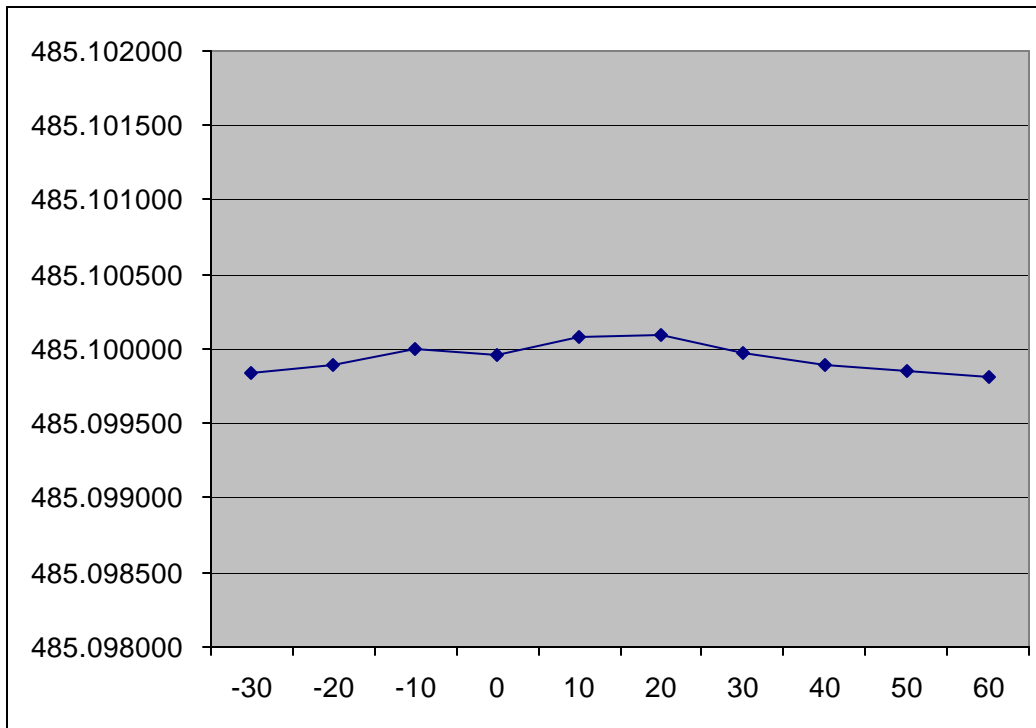

Temperature [°C]	Frequency [MHz]	Frequency drift [ppm]
-30	485.099840	-0.33
-20	485.099899	-0.21
-10	485.100004	0.01
0	485.099965	-0.07
10	485.100087	0.18
20	485.100089	0.18
30	485.099978	-0.05
40	485.099891	-0.22
50	485.099859	-0.29
60	485.099807	-0.40

Verified by:

David E. Lee, FCC Compliance Manager

Name of Test: Frequency Stability (Voltage Variation)
Specification: 47 CFR 2.1055(d)(1)
Guide: ANSI/TIA/EIA-603-1992, Paragraph 2.2.2

Measurement Procedure

- A) The EUT was placed in a temperature chamber (if required) at 25±5°C and connected as shown below.
- B) The power supply voltage to the EUT was varied from 85% to 115% of the nominal value measured at the input to the EUT.
- C) The variation in frequency was measured for the worst case.

Transmitter Test Set-Up: Voltage Variation

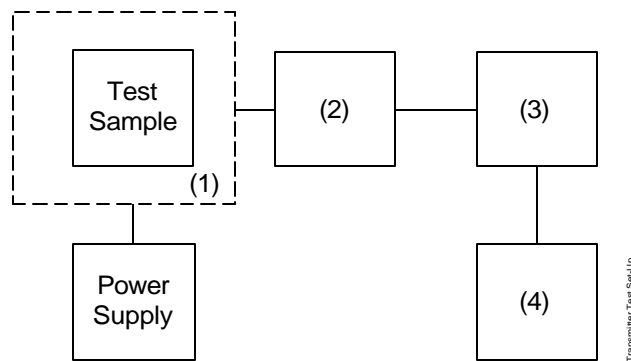

Asset	Description	s/n	Cycle	Last Cal
(1) Temperature, Humidity, Vibration				
i00027	Tenney Temp. Chamber	9083-765-234	NCR	
(2) Coaxial Attenuator				
X i00231/2	PASTERNAK PE7021-30 (30 dB)	231 or 232	NCR	
i00122/3	NARDA 766 (10 dB)	7802 or 7802A	NCR	
(3) RF Power				
X i00020	HP 8901A Power Mode	2105A01087	12 mo.	Apr-05
(4) Frequency Counter				
X i00020	HP 8901A Frequency Mode	2105A01087	12 mo.	Apr-05

Results: Frequency Stability (Voltage Variation)

State: Ambient Temperature: 23°C ± 3°C

Limit, ppm = 1.0
 Limit, Hz = 485
 Battery End Point (Voltage) = 6.00

% of STV	Voltage	Frequency, MHz	Change, Hz	Change, ppm
115	8.63	485.09996	-40	-0.08
100	7.50	485.09998	-20	-0.04
85	6.38	485.09998	-20	-0.04
BEP	6.00	485.09996	-40	-0.08



Performed by: Fred Chastain, Test Technician

Name of Test: Necessary Bandwidth and Emission Bandwidth

Specification: 47 CFR 2.202(g)

Using $(2 \times M) + (2 \times D \times K)$

Modulation = 11K0F3E

Necessary Bandwidth Calculation:

Maximum Modulation (M), kHz	=	3.0
Maximum Deviation (D), kHz	=	2.5
Constant Factor (K)	=	1
Necessary Bandwidth (B_N), kHz	=	11.0

Using $(R / \log^2 S) + DK$

Modulation = 6K00F1E

Necessary Bandwidth Calculation:

Digital Information Rate (R), bps	=	4800
Maximum Deviation (D), kHz	=	1.8
Signaling States (S)	=	4
Constant Factor (K)	=	1
Necessary Bandwidth (B_N), kHz	=	6.0

Modulation = 6K00F1D

Necessary Bandwidth Calculation:

Digital Information Rate (R), bps	=	4800
Maximum Deviation (D), kHz	=	1.8
Signaling States (S)	=	4
Constant Factor (K)	=	1
Necessary Bandwidth (B_N), kHz	=	6.0



Calculated by:

David E. Lee, FCC Compliance Manager

END OF TEST REPORT

**Testimonial
and
Statement of Certification**

This is to Certify:

1. **That** the application was prepared either by, or under the direct supervision of, the undersigned.
2. **That** the technical data supplied with the application was taken under my direction and supervision.
3. **That** the data was obtained on representative units, randomly selected.
4. **That**, to the best of my knowledge and belief, the facts set forth in the application and accompanying technical data are true and correct.



Certifying Engineer:

David E. Lee, FCC Compliance Manager