

FCC STA Application Attachments Antenna Testing

August 10 – September 30, 2014

Rev 1
Updated 2014-07-28

Ground Antenna Detail

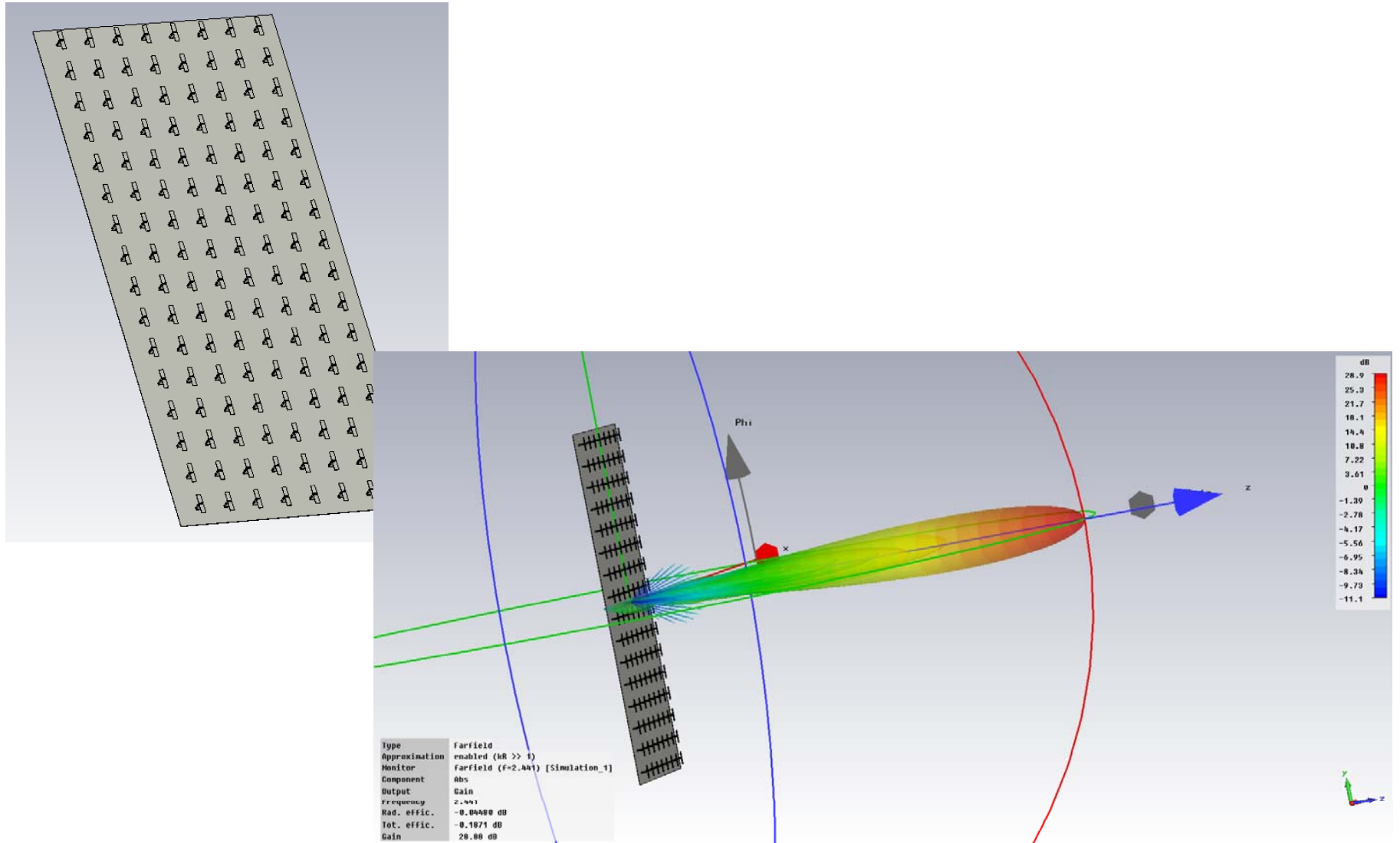

Ground Antenna – Radiation Patterns



Elevation pattern, no up tilt

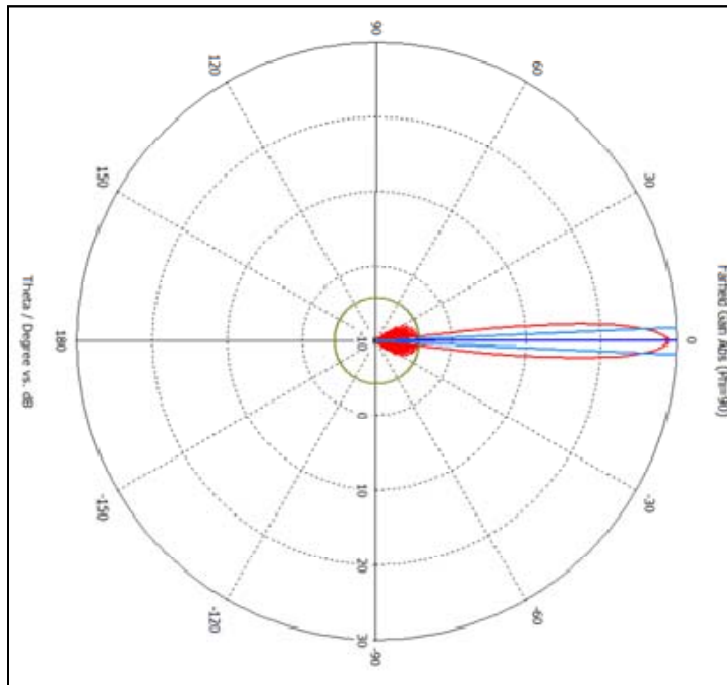

Azimuth pattern

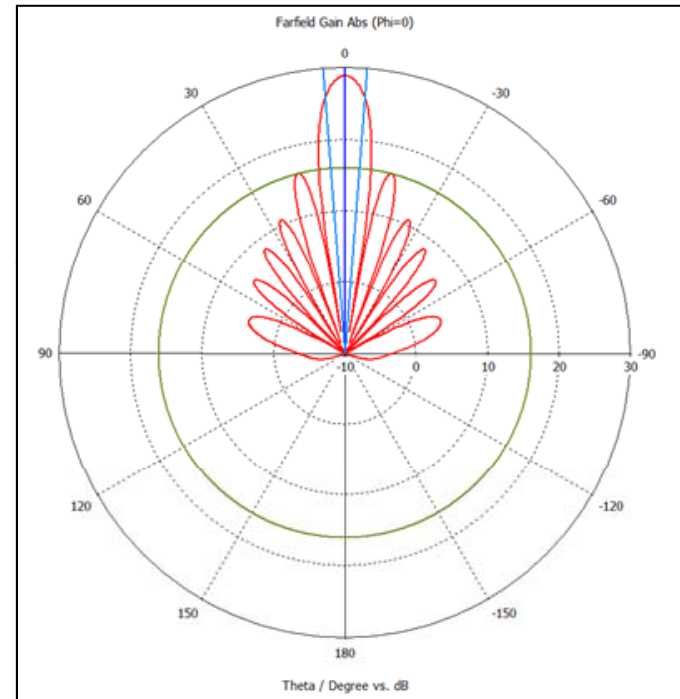

Ground station antenna transmit beam is formed in direction of aircraft.

Ground Antenna Elevation Diagram

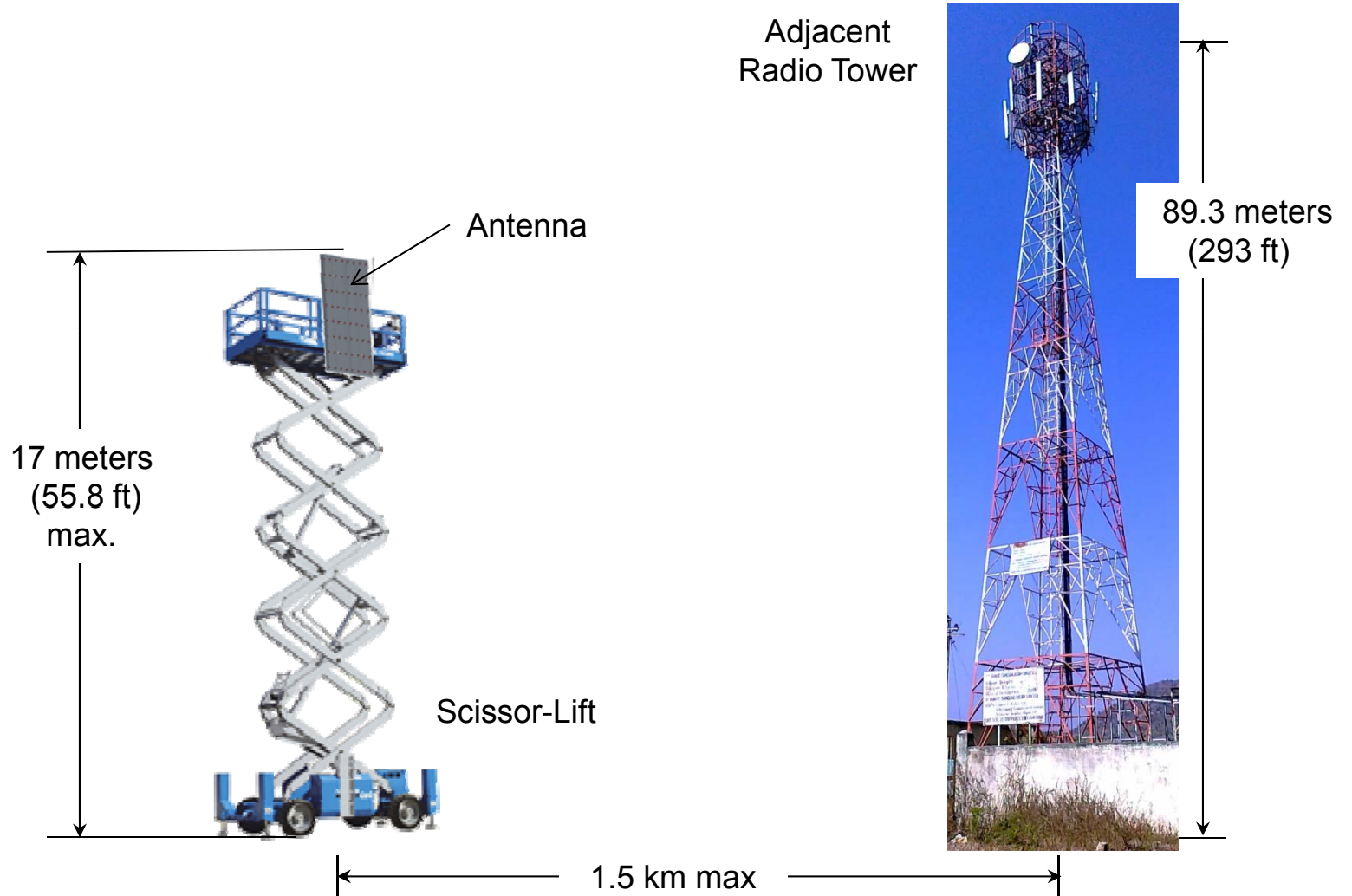

Aircraft Antenna Detail

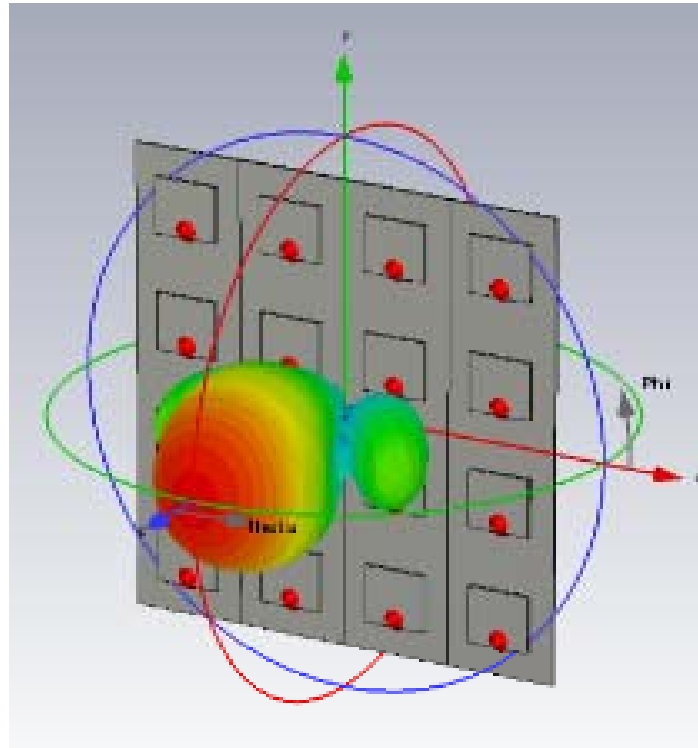

Aircraft Antenna – Radiation Patterns



Elevation pattern

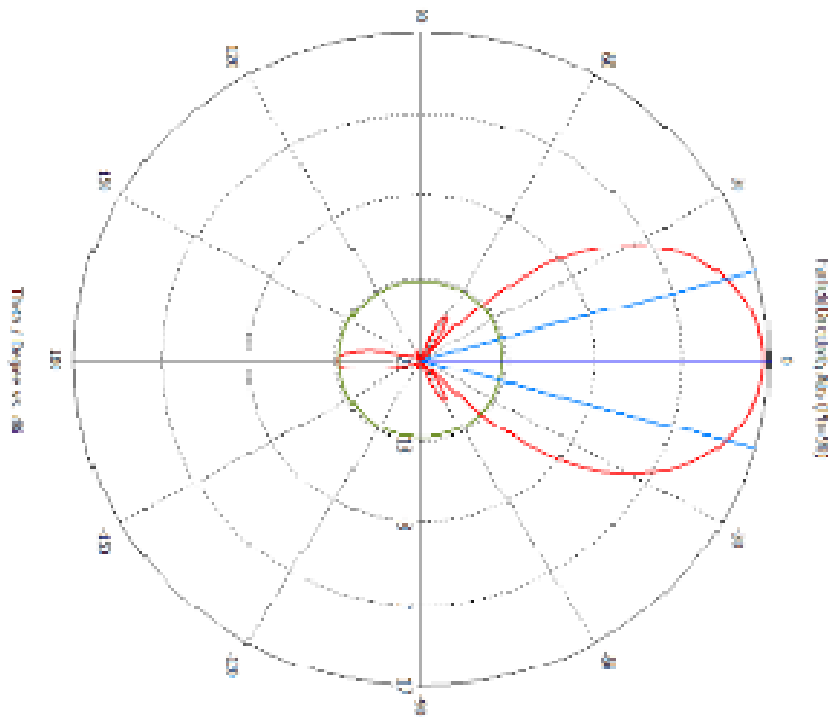

Azimuth pattern

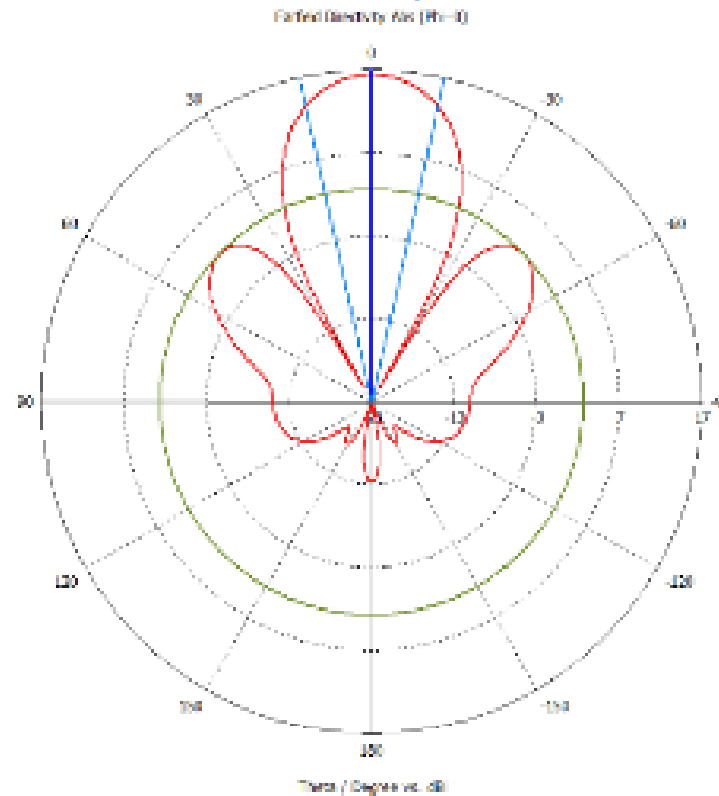

Aircraft station antenna transmit beam is formed toward ground station.