

# GLI-METRO GPS Smart Controller

USER GUIDE



**GPS**  
SOURCE  
GPS LIVE INSIDE



## GLI-METRO Quick Set Up

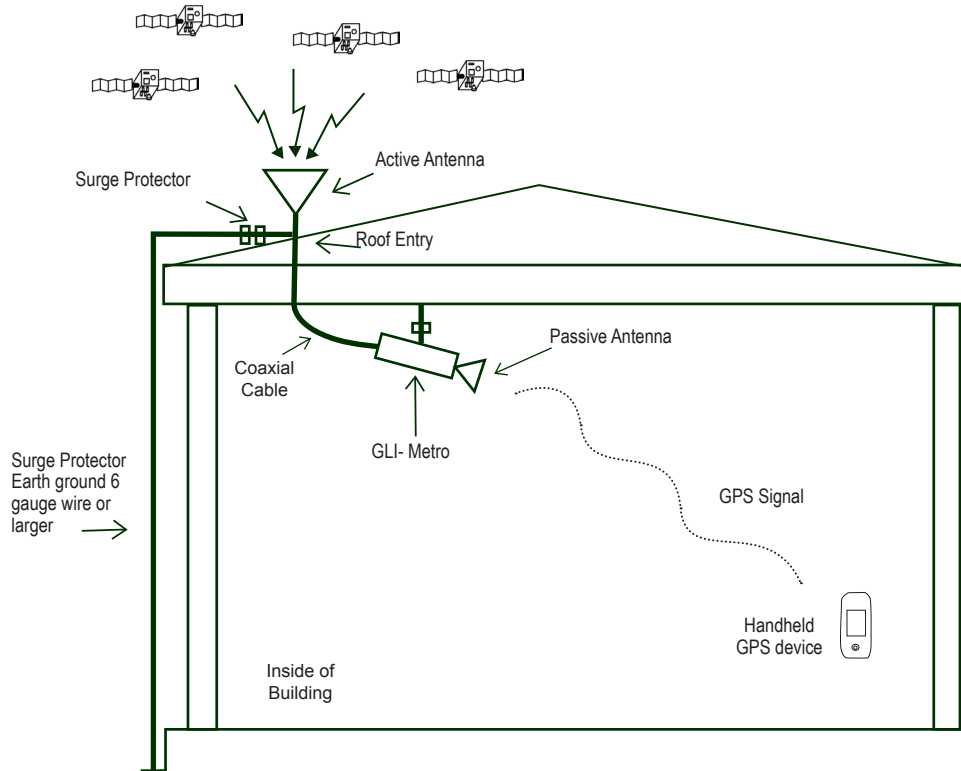

1. Mount the Receive Antenna on the roof at the location with the clearest view of the sky (this may not be the highest point).
2. Attach the coax cable to the Receive Antenna and run the cable through the roof or other convenient location into the building.
3. Attach the Passive Antenna to the output side of the GLI-METRO.
4. Mount the GLI-METRO inside the upper area or region of the building. Rotate the device on the mount, so that the transmitting antenna faces out into the facility. (Avoid facing antenna outdoors, through doors, windows, skylights, etc.)
5. Connect the coax cable to the input connector (left side) of the GLI-METRO.
6. Connect the GLI-METRO to the power supply. Depress the Power button for 2 seconds to enable system power. Once the power is on, the system will begin transmitting the GPS signals within 10 seconds if the system is fully operational.
7. Hold a hand held GPS device at the far end of the area requiring GPS coverage. Adjust power level of GLI-METRO up until handheld device will see 5 satellites.

**DO NOT TURN UP POWER ANY MORE THAN NECESSARY. LESS IS MORE!!**

**Call GPS Source at (719) 561-3680 with Questions.**

USER GUIDE

# GLI-METRO GPS Smart Controller

Version 1.0  
Revision A  
January 2011  
Doc. Num.: 060-DOC-UMN-AAA-AF-001B



## Corporate Office

GPS Source, Inc.  
64 N. Mission Drive  
Pueblo West, CO 81008  
USA  
www.gpssource.com



Headquarters: +1 719-561-9520  
Technical Support: +1 719-561-3680  
Fax: +1 719-565-0890  
Email: info@gpssource.com

## Legal Notices

© 2011, GPS Source, Inc. All rights reserved.

The Bluetooth word mark and logos are owned by the Bluetooth SIG, Inc.

## Release Notice

This is the January 2011 release (Revision A) of the GLI-METRO GPS Smart Controller User Guide, Document Number 060-DOC-UMN-AAA-AF-001B. It applies to version 003 of the GLI-METRO firmware.

## Limited Warranty Terms and Conditions

### Product Limited Warranty

GPS Source Corporation warrants its product free from defects in materials and manufacture for one year from the date of purchase. GPS Source will, at its sole option, repair or replace any components that fail in normal use. Such repairs or replacement will be made at no charge to the customer for parts and labor. The customer is, however, responsible for any transportation costs. This warranty does not cover failures due to damage or defects caused in whole or in part by reason of fire, explosion, flood, acts of God, extreme weather conditions, abuse, vandalism, negligence, misuse, accidents or unauthorized alteration or repairs.

THE WARRANTIES AND REMEDIES CONTAINED HEREIN ARE EXCLUSIVE AND IN LIEU OF ALL OTHER WARRANTIES EXPRESS OR IMPLIED OR STATUTORY, INCLUDING ANY LIABILITY ARISING UNDER ANY WARRANTY OF

MERCHANTABILITY OR FITNESS FOR A PARTICULAR PURPOSE, STATUTORY OR OTHERWISE. THIS WARRANTY GIVES YOU SPECIFIC LEGAL RIGHTS, WHICH MAY VARY FROM STATE TO STATE. IN NO EVENT SHALL GPS SOURCE BE LIABLE FOR ANY INCIDENTAL, SPECIAL, INDIRECT OR CONSEQUENTIAL DAMAGES WHETHER RESULTING FROM USE, MISUSE, INABILITY TO USE THIS PRODUCT OR FROM DEFECTS IN THE PRODUCT. SOME STATES DO NOT ALLOW THE EXCLUSION OF INCIDENTAL OR CONSEQUENTIAL DAMAGES, SO THE ABOVE LIMITATIONS MAY NOT APPLY TO YOU.

## How To Obtain Warranty Service

Call the GPS Source Customer Support Department (719) 561-9520 for a returned merchandise authorization (RMA) number. The unit should be securely packaged with the RMA number clearly marked on the outside of the package and sent freight prepaid to GPS Source. A copy of the original sales invoice is required as the proof of purchase for warranty repairs. GPS Source retains the exclusive right to replace the unit or offer a full refund of the purchase price at its sole discretion. SUCH REMEDY SHALL BE YOUR SOLE AND EXCLUSIVE REMEDY FOR ANY BREACH OF WARRANTY.

## Warranty Exclusions and Disclaimer

This Product limited warranty shall only apply in the event and the extent that (i) the Product is properly and correctly installed, configured, interfaced, maintained, stored, and operated in accordance with this manual and specifications, and; (ii) the Product is not modified or misused or (iii) damage caused by: accident, lightning or other electrical discharge, fresh or salt water immersion or spray; or exposure to environmental conditions for which the Product is not intended. GPS Source does not warrant or guarantee the results obtained through the use of the Product.

# TABLE OF CONTENTS

QUICKSTART.....	i
Chapter 1	
Introduction .....	1
About the GLI-METRO .....	1
Related Information (Contacts).....	2
Chapter 2	
Overview .....	3
System Description.....	4
Basic Functions .....	4
System Block Diagram .....	5
Keypad and Display.....	6
GLI-METRO User Interface .....	6
GLI-METRO Power .....	7
Equipment/Hardware Required .....	7
Antennas .....	8
Mounting Hardware .....	8
Chapter 3	
Installing the GLI-METRO .....	11
Antenna Mounting .....	12
Cable & Routing .....	12
Surge Suppressor Location .....	13
GLI-METRO Mounting Requirements .....	14
GLI-METRO Typical Configuration .....	15
Transmit Power Level .....	17
Chapter 4	
Configuring the GLI-METRO .....	19
Button Functions .....	20
Appendix A	
Serial Port Commands .....	29
Appendix B	
Troubleshooting .....	33
Fault Codes.....	36
Glossary of Terms .....	38



Chapter

1

## INTRODUCTION

Welcome to the GLI-METRO System User Guide. This manual describes how to set up and use the GLI-METRO GPS Smart Controller.

Even if you have used other Global Navigation Satellite System (GNSS) products before, GPS Source recommends that you spend some time reading this manual to learn about the special features of your GPS Smart Controller.

### About the GLI-METRO

The GLI-Metro has a built in GPS receiver that measures the power on the output connector so that the GPS signal level from the device can be known exactly. It has been designed with a built in testing feature, that allows each hardware component to be monitored, confirming that the system is fully operational. It is controlled either by push buttons on the front user input panel and/or via an optional serial port interface.

## Features

- Precise control over output signal level
- Passes L1 (L1/L2 optional)
- High frequency selectivity
- Conditions signal/prevents changes in performance
- Oscillation detection and mitigation
- Antenna monitor with alarm
- Bluetooth available



## **Related information**

Sources of related information include the following:

- Help - GPS Source offers tech support for the GLI-METRO via email at  
  
support@gpssource.com, or  
phone: +1 719-561-3680.
- Training - Consider a training course to help you use your GLI-METRO system to its fullest potential. For more information, go to the GPS Source website at [www.gpssource.com/services](http://www.gpssource.com/services).

## **Technical Support**

If you have a problem and cannot find the information you need in the product documentation, contact us at [www.gpssource.com/contact](http://www.gpssource.com/contact).

Chapter

2

## GLI-METRO Overview

This chapter introduces the GLI-METRO GPS Smart Controller. The GPS Smart controller makes it easy to set up a system that allows one to receive GPS signals inside a building or structure.

### Features:

- Serial Port
- Input Connector
- Power Button (Options)
- User Input Display
- Transmit and Fault Indicator Lights
- ERP Signal Level Adjustment
- Brightness Level Adjustment
- Output Connector



Figure 1. GLI-METRO GPS Smart Controller

## System Description

The GLI-METRO receives the L1 GPS Signal from a 3.4" active antenna that is usually placed on the outside of a hangar facility or large building (preferably highest point on the roof).

## Basic Functions

**Amplifies the Signals:** The GLI-METRO amplifies the GPS signals to a level for retransmission from the receive antenna that is sufficient for signal coverage throughout any small to large indoor space.

**Employs Power Control:** The GLI-METRO employs a power control function which measures the output power of the GPS signals from the device and controls the gain based on the user's selection on the input panel. This ensures the necessary radiated power level is achieved within the designated facility.

**Distributes Signals:** The GLI-METRO may be combined with additional GPS signal splitters, and retransmission antennas to cover a larger area.

**Performs Built in Test (BIT):** The GLI-METRO performs a continuous built in test function, monitoring the status of coaxial cables to and from the device, as well as the GPS signal levels and signal quality within the device itself.

**Provides Diagnostic Port:** The GLI-METRO has a diagnostic port that can be monitored by way of a laptop computer RS232 port in order to test and determine the status of the system (Bluetooth compatible).

**Provides Real-time Status Signal:** The GLI-METRO provides a status signal (XMIT OR FAULT) to the user input panel.

**Receives Power:** The GLI-METRO receives 16 VDC from a standard 110 VDC wall plug power.

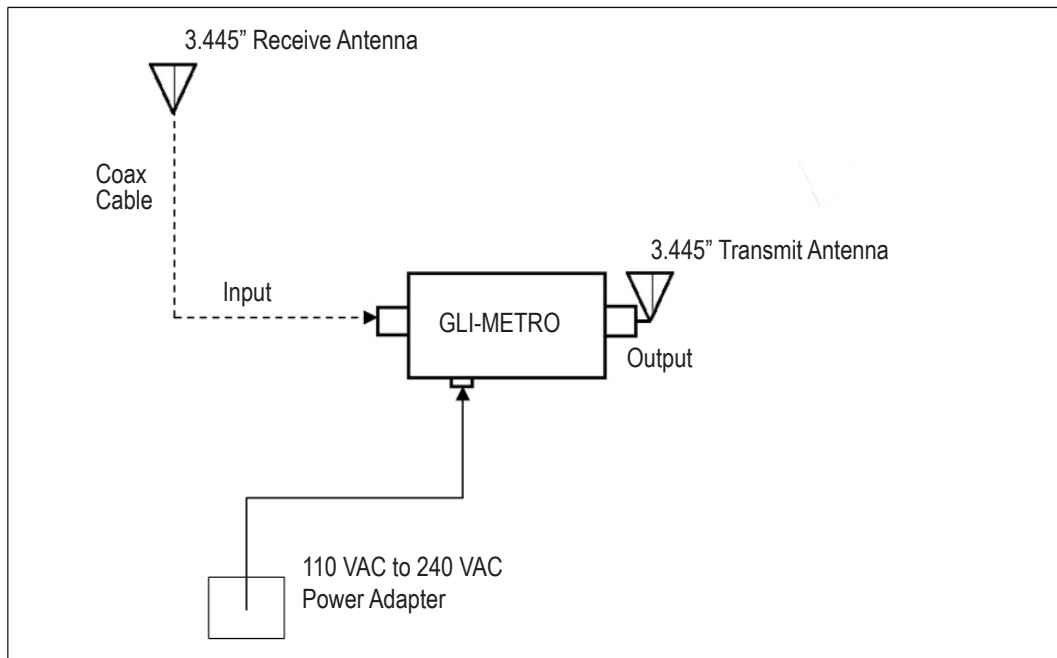

Figure 2. GLI-METRO System Block Diagram

## Keypad and Display



- Input Connector
- Power Button
- User Input Display
- Transmit and Fault Indicator Lights
- ERP Signal Level Adjustment
- Brightness Level Adjustment
- Output Connector
- RS232 Port

### GLI-METRO User Interface

**Input Connector:** Connects device to active antenna via cable.

**Power Button:** There are two options for powering. The GLI-METRO will ship one of the options.

Option 1: “Power Constantly On. Once connected to a power source, the GLI-METRO will power ON and remain ON, until the device is disconnected from the power source. The system will begin transmitting the GPS signals within 10 seconds if the system is fully operational. Although the System will begin transmitting within 10 seconds, it may require as much as 4 minutes to become fully initialized.

Option 2: Power On/Off. Once connected to a power source, depress the Power button for 2 seconds to enable system power. Once the power is ON, the system will begin transmitting the GPS signals within 10 seconds if the system is fully operational. Although the System will begin transmitting within 10 seconds, it may require as much as 4 minutes to become fully initialized.

**User Input Display:** Display will illuminate along with the user input buttons. The DISPLAY indicates the power level/brightness level of the GLI-METRO. The DISPLAY will also indicate any faults detected by the GLI-METRO.

If the FAULT light remains illuminated after the system has initialized, then revisit the system installation to ensure all system components have been properly installed/connected.

**Transmit and Fault Indicator Lights:** Will communicate health of system.

**XMIT LED** indicates the transmit status of the GLI-METRO. If XMIT is illuminated, the GLI-METRO is transmitting the GPS signals through all operational GPS Retransmission Antennas. If XMIT is flashing, the GLI-METRO is acquiring satellites.

**FAULT LED** indicates the status of the automated Built In Test (BIT) functionality. If FAULT is illuminated, there exists some anomaly within the GLI-METRO which will be shown on the display. Go to page 36 for more information.

**ERP Signal Level Adjustment:** The POWER LEVEL buttons are used to set the output power of the GLI-METRO. The range of output power level adjustment is -85dBm to -65dBm.

**Brightness Level Adjustment:** The BRIGHTNESS buttons are used to adjust the illumination intensity of the front panel of the GLI-METRO. Note: depressing the down button beyond its lowest setting will turn off the user input panel lights; however, the unit will still operate. *This setting is **not recommended**.*

**Output Connector:** Connects device to passive antenna.

**Serial Port:** The GLI-METRO can be controlled and monitored via a RS232 serial port. The GLI-METRO is designed so that a controlling computer can, with terminal emulation software, e.g. HyperTerminal, send commands and receive information. A user can type specific commands, rather than selecting commands from a predefined user interface. See Appendix A for further information about RS232 Serial Interface References.

## GLI-METRO Power

### Input Power Requirements

The GLI-METRO operates on 16 volts DC input from standard 110 AC wall plug power transformer.

### Power Options

See page 12.

## Equipment/Hardware Required

This GLI-METRO unit can be purchased as a standalone without antennas or cabling. But, it will require antennas and cabling in order to become a working unit. If you are replacing an existing GPSRKXLV device, your existing hardware is backwards compatible. If you purchased the GLI-METRO as a standalone unit, instead of a kit, all of the requisite antennas, cabling, brackets and mounts can be purchased through GPS Source or one of our resellers. Call (719) 561-9520 to discuss your needs.

When sourcing material, make sure you get the right connectors for your cabling and antennas. The standard GLI-METRO will ship with a female N connector on the input and a male N connector on the output. See example below:

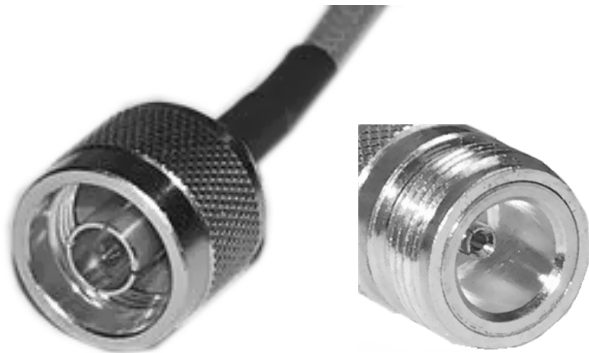

N Connectors (Male - Female)

## Other Common RF Connectors



SMA Connectors (Male - Female)



BNC Connectors (Male & Female)



SMC Jack



SMB Jack



TNC Connectors (Male & Female)

## Antennas

### GPS Active Antenna

The GPS active antenna includes a low noise amplifier (LNA). The LNA is necessary to make up for the signal loss that is inherent in all antenna cables. The GPS active antenna may be mounted on a pole-mount bracket, stand-alone or other suitable mount.



### GPS Passive Antenna

The GPS passive antenna receives the L1 GPS signal from the GLI-METRO and transmits the GPS signal throughout the facility or area.

The GPS antennas also include custom circuitry to enable the GLI-METRO to monitor the operational status of the individual antennas.

## Mounting Hardware

The GLI-Metro will be provided with standard Gimbal adjustable mounting brackets/ swivel mount. Other various mounting hardware are available depending on the system configuration or application.

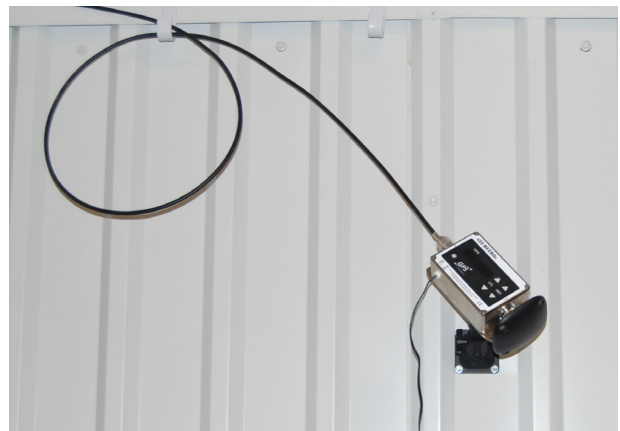





## Installing the GLI-METRO

This chapter describes best practices for setting up the equipment, and outlines the precautions that you need to take to protect the equipment.

### Features:

- Antenna Mounting
- Cable Routing
- Surge Protection
- Repeater Mounting
- Setup Guidelines
- Transmit Power Level

## Antenna Mounting

- GPS Source recommends a site as free as possible from interference, where the antenna has a clear view of the sky and where there are no obstructions above 10° elevation.
- GPS Source recommends that you install lightning protection equipment for your GLI-METRO. We recommend the CO-PRO Surge/Coax protector in the antenna feed line as well as appropriate safety grounding.

Protect any communications and power lines at building entry points. If you use other antennas or aerials, such as a radio modem that distributes real-time correction messages, consider protecting those antennas as well.

- Never route lightning inside structure (See illustration on next page)
- Avoid vertical roof penetration wherever possible, this will help to avoid leaks.
- Avoid sky lights and windows where the output of the repeater can be directed at the receive antenna and cause oscillation.
- Avoid areas where snow and ice accumulate, which limit ability of antenna to receive signal
- Avoid locating near high power transmitters
- Weather proof all coaxial connections

## Cable & Routing

- Use plenum cable where required by fire codes
- Provide support for cables to limit tension
- Maintain minimum bend radius of cable
- Remove any twist in coaxial cable to avoid kinks
- Never pull cable by the ends
- Provide proper torque of connectors, too loose poor connection, too tight causes connector damage
- Never step on or drive over coaxial cables, crushed dielectric causes impedance mismatch
- Always use cabling with soldered center pins for the RF connectors (NOT crimp only)

### Surge Suppressor Properly Located

This will route any energy from a lightning strike to ground before it enters the building

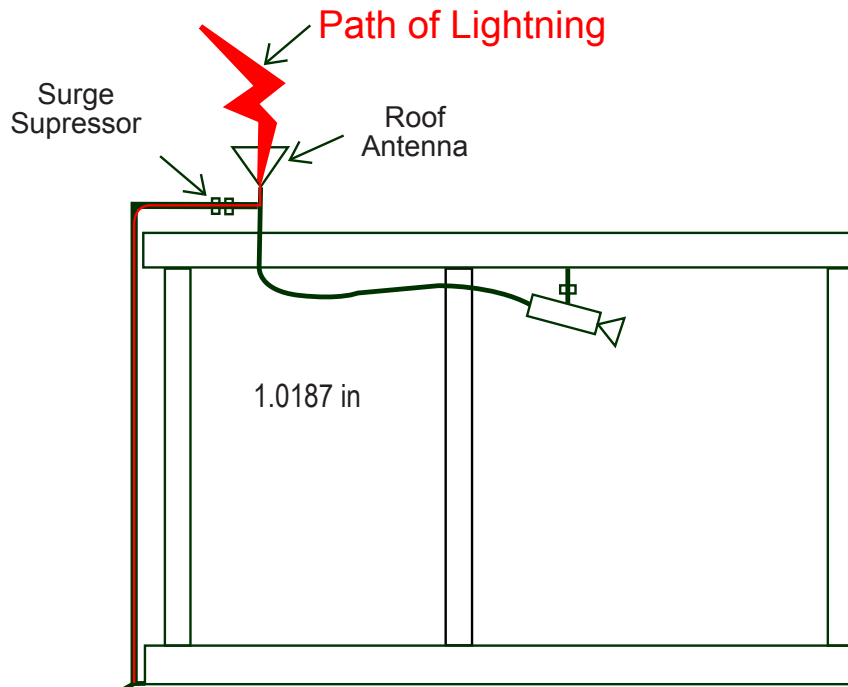

### Surge Suppressor Improperly Located

This will route any energy from a lightning strike **INTO** your building

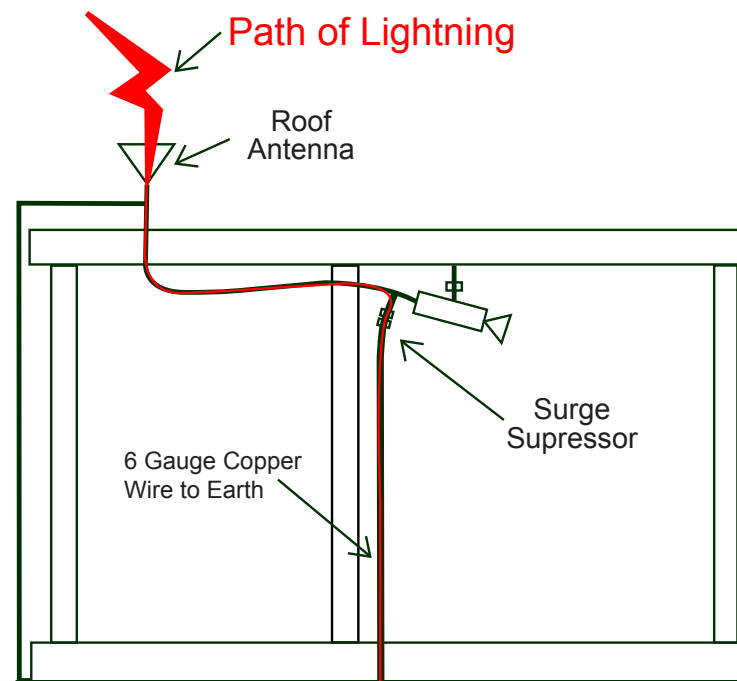

## GLI-METRO Mounting Requirements

The GLI-METRO should be mounted in the upper area or region of a given facility that is easily accessible or can be reached by a lift. Rotate the device on the gimbal mount, so that the transmitting antenna faces out into the facility.



## Repeater Mounting

- Higher mounting is better, less chance for masking
- Try to minimize reflections
- Transmit antenna can be remotely located from the GLI-METRO using the cable offset mode
- Avoid heat sources

**GLI-METRO Typical Configuration**

The following diagram depicts a typical GPS Smart Controller system. This is by no means standard, as each system can have different combinations of components to suite the individual requirements of each installation. But there are common components in most GLI-METRO networked systems.

Each system will normally begin with a roof or receive antenna or GPS signal source. In order to achieve and maintain a suitable system noise figure, the receive antenna will usually be an active component, i.e. have an integrated LNA (low noise amplifier/or low noise preamplifier). An LNA's active circuitry requires power and the standard way to provide power is a DC voltage via the center conductor of the coaxial cable.

Before you mount the receive antenna, plan the best location for the antenna. Try to determine a location that will allow you a clear line of sight to satellite signals. GPS Source recommends a site as free as possible from interference, where the antenna has a clear view of the sky and there are no obstructions above 10° elevation. If there are obstructions above 10°, or large metallic objects nearby, the antenna may be limited in collecting accurate data from enough satellites.

**Antenna cabling**

Many GLI-METRO installations have unique cabling requirements. Depending on the available infrastructure, you may need to mount the antenna a substantial distance from the receiver. The GLI-METRO can operate at an input signal level of -115 dBm. The degree of loss in a coaxial cable depends on the frequency of the signal passing through it. Refer to the table on page 18 for more information.

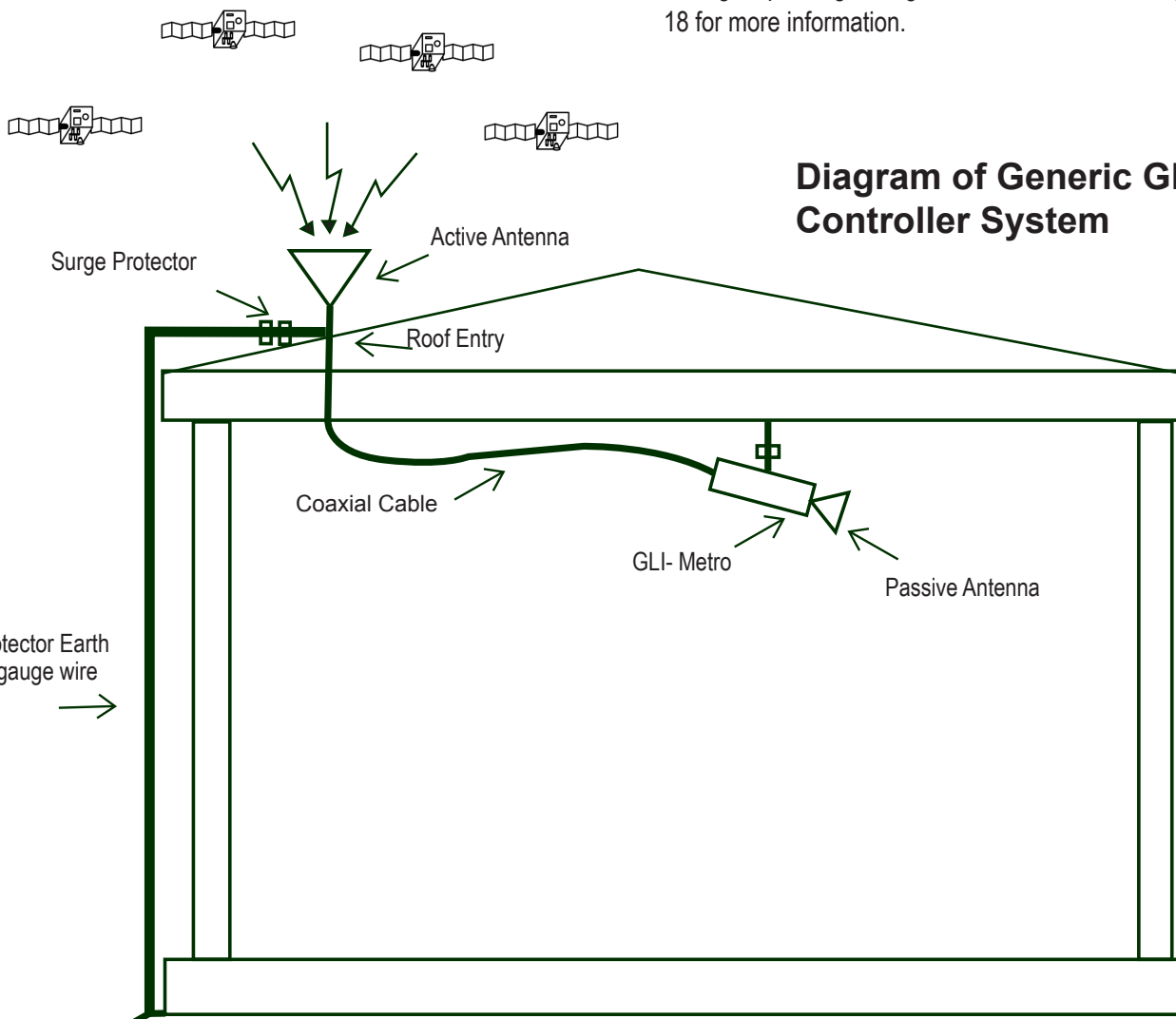

**Diagram of Generic GPS Smart Controller System**

### Setup Guidelines

When you set up the receiver, follow these guidelines.

### Environmental Conditions

The GLI-METRO does NOT have waterproof housing. You should take reasonable care to keep the unit dry

Avoid exposing the device to extreme environmental conditions, such as:

- Water
- Heat greater than 65 °C (149 °F)
- Cold less than -40 °C (-40 °F)
- Corrosive fluids and gases

### Lightning Protection

GPS Source recommends that you install lightning protection equipment for your GLI-METRO. We recommend the CO-PRO Surge/Coax protector in the antenna feed line as well as appropriate safety grounding.

Also, protect any communications and power lines at building entry points. If you use other antennas or aerials, such as a radio modem that distributes real-time correction messages, consider protecting those antennas as well.

### Placing the Active (Receive) Antenna Outdoors

Before you mount the antenna, you should plan the best location for the antenna. GPS Source recommends a site as free as possible from interference, where the antenna has a clear view of the sky and where there are no obstructions above 10° elevation.

### Connecting the GLI-METRO to the Receive Antenna

The GLI-METRO will be connected to the receive antenna, with a cable. GPS Source recommends the LMR240 (up to 100 feet). If you will be using more than 100 feet of cable, please see GPS Source website for link budget calculations or call (719) 561-9520.

## The Length and Type of Antenna Cabling Can Directly Affect the Quality of Signal

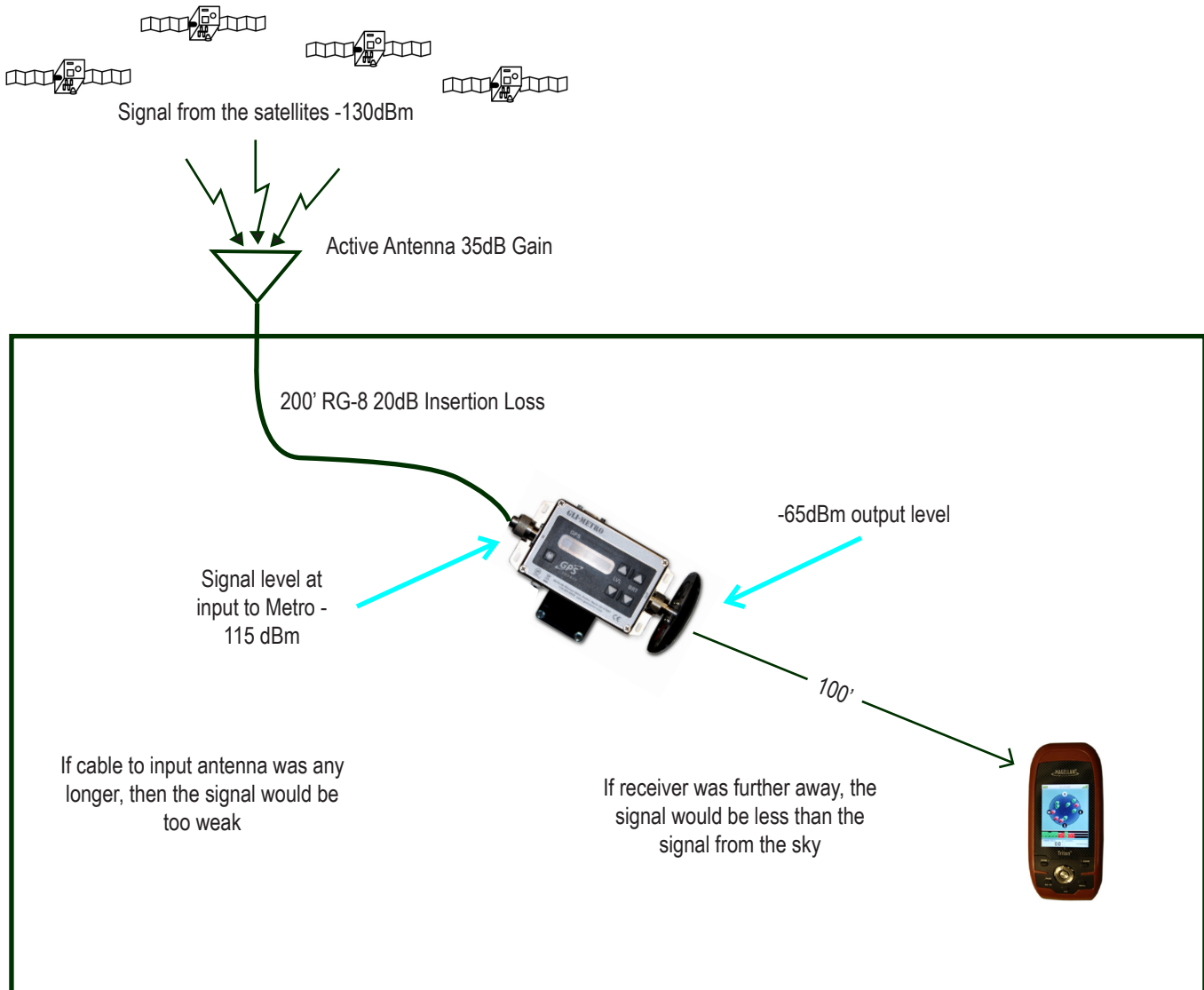

The length of the cable and the type of cable, can affect the dynamic range of the GLI-METRO (or any GPS device). The dynamic range is essentially the range of signal levels over which it can operate. The low end of the range is governed by its sensitivity. While at the high end, it is governed by its overload or strong signal handling performance.

The GLI-METRO has an input dynamic range of 30dB, i.e. the input can vary from -115 min to -85 max. It has an output dynamic range of 20dB i.e., it can transmit from -85dBm to -65dBm provided the input level is within the min and max level as shown above.



## Transmit Power Level

Lower power creates a better quality and safer signal. Raising the power level too much is counter-productive and can decrease signal reliability

Too much power can cause:

- Reflections
- Overdrive Receivers
- Leakage outside structure

Use only enough power to reach intended target.  
Avoid aiming the transmit antenna at a window or door

## Oscillation

Too much power can cause oscillation, significantly decreasing signal quality. This will be detected by the GLI-METRO, but needs to be resolved by turning down the power. Oscillation can also be caused by the transmitting antenna and the receive antenna being pointed in each other's direction.

## Transmitted Power (L1 only)

## Range in Feet

↓	10	20	30	40	50	60	70	80	90	100
-85	-131.1	-137.1	-140.6	-143.1	-145.1	-146.7	-148	-149.2	-150.2	-151.1
-84	-130.1	-136.1	-139.6	-142.1	-144.1	-145.7	-147	-148.2	-149.2	-150.1
-83	-129.1	-135.1	-138.6	-141.1	-143.1	-144.7	-146	-147.2	-148.2	-149.1
-82	-128.1	-134.1	-137.6	-140.1	-142.1	-143.7	-145	-146.2	-147.2	-148.1
-81	-127.1	-133.1	-136.6	-139.1	-141.1	-142.7	-144	-145.2	-146.2	-147.1
-80	-126.1	-132.1	-135.6	-138.1	-140.1	-141.7	-143	-144.2	-145.2	-146.1
-79	-125.1	-131.1	-134.6	-137.1	-139.1	-140.7	-142	-143.2	-144.2	-145.1
-78	-124.1	-130.1	-133.6	-136.1	-138.1	-139.7	-141	-142.2	-143.2	-144.1
-77	-123.1	-129.1	-132.6	-135.1	-137.1	-138.7	-140	-141.2	-142.2	-143.1
-76	-122.1	-128.1	-131.6	-134.1	-136.1	-137.7	-139	-140.2	-141.2	-142.1
-75	-121.1	-127.1	-130.6	-133.1	-135.1	-136.7	-138	-139.2	-140.2	-141.1
-74	-120.1	-126.1	-129.6	-132.1	-134.1	-135.7	-137	-138.2	-139.2	-140.1
-73	-119.1	-125.1	-128.6	-131.1	-133.1	-134.7	-136	-137.2	-138.2	-139.1
-72	-118.1	-124.1	-127.6	-130.1	-132.1	-133.7	-135	-136.2	-137.2	-138.1
-71	-117.1	-123.1	-126.6	-129.1	-131.1	-132.7	-134	-135.2	-136.2	-137.1
-70	-116.1	-122.1	-125.6	-128.1	-130.1	-131.7	-133	-134.2	-135.2	-136.1
-69	-115.1	-121.1	-124.6	-127.1	-129.1	-130.7	-132	-133.2	-134.2	-135.1
-68	-114.1	-120.1	-123.6	-126.1	-128.1	-129.7	-131	-132.2	-133.2	-134.1
-67	-113.1	-119.1	-122.6	-125.1	-127.1	-128.7	-130	-131.2	-132.2	-133.1
-66	-112.1	-118.1	-121.6	-124.1	-126.1	-127.7	-129	-130.2	-131.2	-132.1
-65	-111.1	-117.1	-120.6	-123.1	-125.1	-126.7	-128	-129.2	-130.2	-131.1

Chapter

4

## Configuring the GLI-METRO





The GLI-METRO features a keypad and display so that you can configure the device to fit your specific needs

### Features:

- Button functions
- Power button operations
- Status Display
- Setting up the GLI-METRO

## Button Functions





The GLI-METRO five buttons on the front panel. Use the buttons to turn the device on and off and to check or change unit settings.

Button(s)	Function	Button(s)	Function
	Turn on/off the device. To turn off the GLI-METRO, hold the power button for two seconds.		Pressing and holding the BRT UP and BRT DN buttons for 3 seconds allows user to enter additional system gain for high loss cables "CBL OS:#" BRT buttons select desired setting 0 = no additional gain 5 = 5dB additional gain
	Pressing and holding the LVL UP and LVL DN buttons for 3 seconds allows user to lock the power level LVL buttons after selecting desired setting		
<b>LVL</b>			
	Y = User power level is locked N = User power level is adjustable		
	3 seconds after last button press, the input is accepted and "REMLVL:?" is displayed Y = User set power level will persist after a system reset N = User set power level will be 0 after system reset		
	3 seconds after last button press, the input is accepted and system returns to normal operating mode		3 seconds after last button press, the input is accepted and system returns to normal operating mode

**NOTE:** Raising the power level too much is counter-productive and can decrease signal reliability

## L2 Offset Mode

Only for GLI-METRO with L2 option..

Button(s)	Function
 <b>LVL</b>  <b>BRT</b>	Pressing and holding the BRT DN and LVL UP buttons for 3 seconds allows user to change the offset between L1 and L2 signal "L2OS: -#"
 	LVL buttons select desired setting 0 = no offset between L1 and L2 signals -5 (default) = L2 signal is -5dB -10 = L2 signal is -10dB
	3 seconds after last button press, the input is accepted and system returns to normal operating mode
	<i>L2 offset mode is useful as a unit can oscillate on an L2 channel but will be fine on the L1</i>



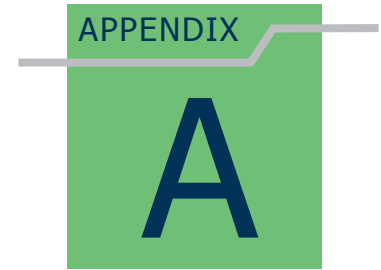

## **Serial Port Commands**

The GLI-METRO features a keypad and display so that the device can be configured without using a computer. Unfortunately, the GLI-METRO is often mounted in an area that is not easily accessible. GPS Source addresses this issue by providing a serial port. This port allows full control of the device with a cable and a computer. A Bluetooth wireless transceiver option is also available.

## GLI-METRO Serial Interface Reference

### Serial Port Configuration

The serial port comes configured from the factory set to operate at 19200,N,8,1 ONLY! It will not operate at any other setting. There is no hardware handshaking and all that is needed is RX, TX & GND. Some functions are only available via a serial port control, e.g. setting the antenna current fault threshold level.

### Port Hardware

The control of the unit via the serial port is generally accomplished in one of two ways, command mode or terminal mode.

### Terminal Mode

One can connect to the device using a standard terminal device or, a more likely scenario, a computer utilizing some terminal emulation software such as Hyperterm, Terra Term, Kermit, etc.

The unit can be operated with the down arrow keys and the enter keys in exactly the same manner as if one were pressing the buttons on the front panel of the device by navigating the menus and using the up, down arrow keys and enter key or equivalent esc sequences. The device will echo the text to the serial port and in most case it will be the same as the front panel LCD or it will be more verbose.

### Note:

The letter "D" & "d" will also function as the down arrow key and the letter "U" & "u" will function as the up arrow key.

The terminal ESC sequences ESC[B] or 0x1B and then a 0x41 will function as an up arrow key.

The terminal ESC sequences ESC[A] or 0x1B and then a 0x41 will function as an up arrow key.

(If there are any dinosaurs reading this these are VT100 terminal escape sequences)

### Command Mode

In command mode, the unit can be controlled or operated by sending specific commands as opposed to navigating menus via key strokes. Though there is nothing stopping a user from sending individual key strokes, i.e. characters programmatically and navigating menus, it is not needed or recommended. A command set is provided to execute functions directly, so the unit can be controlled by a machine or computer as in an automatic test setup.

### Command Format

The commands are in the format where the first character is always an asterisk followed by a three letter command (case insensitive), followed by an equal sign and any required numeric or character data.

All commands must be terminated by a carriage return character, i.e. 0x0d.

For example, to set the attenuation level, the command is '\*ATT=00', where 00 is some value between 0 and 63. (Note: Leading zeros are required for all numeric values, e.g. attenuation level of one is '\*ATT=01 not '\*ATT=1'.)

This will set the level of attenuation directly without having to navigate the menu system. If the command was accepted, the device will echo a prompt plus the three letter command and the equal sign and any numeric value that accompanied the command plus an OK.

If the command '\*ATT=63' is accepted, then the device will echo GPSS>ATT=63 OK (Note: The asterisk is not echoed!) If the command was not accepted, then the device will only echo the prompt GPSS>.

Command	Description	Range	Default	Comments
*STL	Sets the desired signal level output of the device	-86dBm to -65dBm	-85dBm	This command sets the user controllable attenuator and accomplishes the same thing as adjusting the level on the front panel. The minus sign is assumed when sending this command.
*CON=	Places the device into manual control mode or removes it from calibration mode	0-1	0	Places the device into manual control mode where the control loop is broken. The *RFG=, *ATT=, *GTN= commands will not be overruled/over ridden by the control loop.
*ATT=	Set attenuation level	00-68	Varies based on the input signal level	This sets the level of the attenuator which sets the overall gain (positive or negative) of the device from input to output. Note: it accomplishes the same thing as the RFG command. Attenuation is a positive number and no leading plus or minus sign is needed.
*RFG=	Set amplifier gain	-23 to +45	Varies based on the input signal level	This sets the overall gain of the device, similar to the ATT command. Plus or minus sign and leading zeros are required. Note: Unless in manual control mode, the control loop will override this command.
*BRT=	Set the LCD backlight level	0-7	4	Default is 4 brightness
*ANT=	Turn on/off power to antenna	0-1	1	Turn ON/OFF power supply providing power to the antenna. Default is ON.
*AFH=	Antenna current fault high threshold	0000-1023	516	This sets the high level current fault threshold level i.e. any level above this value will cause a fault and remove power from the antenna.
*AFL=	Antenna current fault low threshold	0000-1023	13	This sets the low level current fault threshold level i.e. any level below this value will cause a fault to be reported.
*GTN=	Set the signal level to the internal GPS receiver	00-31	0	Controls the signal level seen by the GPS receiver.



Command	Description	Range	Default	Comments
*DSN=	Returns serial number	A00000	ANNNNN	Returns serial number. The return string will include the command and OK, e.g. "DSN=A12345 OK"
*AVD=	Returns antenna voltage	N/A	00.00	Returns the antenna voltage. Format returned is two digits and two decimal places, e.g. AVD=05.45 OK
*CLV=	Returns the signal average strength from the GPS receiver	N/A	-85	Returns the signal strength at the output port.
*VER=	Returns software version	000-999	N/A	Three digit software revision
*FOL=	Fixed output level	0 to 3	0	<p>0 = power level is unlocked and unit will not remember last power level after restart</p> <p>1 = power level is locked and unit will not remember last power level after restart</p> <p>2 = power level is unlocked and unit will remember last power level after restart</p> <p>3 = power level is locked and unit will remember last power level after restart</p>

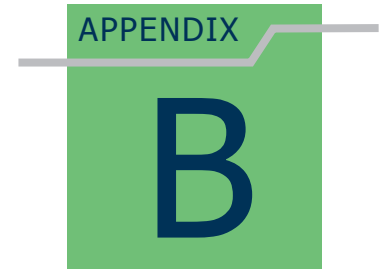

## Troubleshooting

Use this appendix to identify and solve common problems that may occur with the GLI-METRO. Please read this section before you contact Technical Support.

### In This Appendix:

- Reason for Cable Failure
- Fault Isolation
- Ways to Troubleshoot

### GLI-METRO On/Off Power

**Symptom:** Unit will not turn off by depressing Power Button.

The GLI-METRO is configured to power one of two ways. If unit will not turn off, unit has not been configured with that option. See page 12.

### Common Cable Failures

Most cable failures appear during installation or shortly thereafter, due to improper assembly or improper installation. Cable failures can occur any time during the life of a network, but generally speaking, cable failures in fixed installations will appear early on. On the other hand, cables that are moved each day, e.g. those that are connected to an antenna near a field coupler that is used in a production test cell environment, can suffer many failures from fatigue due to strain and repetitive stress.

### Reasons for Cable Failure:

#### Installation

- Improper assembly

#### Improper Installation

- failure to install waterproofing can lead to fungus growth and/or corrosion.
- excess tension stretching of the cable
- crushing of the dielectric

#### General Use

- Fatigue due to strain and repetitive stress

### Fault Isolation

The first step to assessing the performance of a GPS network is to determine what type of failure that is being experienced. Is the failure system wide or is the failure isolated to an individual output or section of the network. In general, the GLI-METRO is smart enough to determine what the failure is and communicate this to the user through a series of "fault codes". These codes can be found on page viii.

Components that comprise a GLI-METRO signal distribution are sometimes powered individually via external sources. This has considerable implications for diagnosing failures in a GPS network due to the dependency of some components that are powered by other components.

### Isolated failures

If the failure is confined to a single leg or output, the diagnosis can be fairly straightforward. One can accomplish this by swapping out similar components. With the GLI-METRO, this will normally involve swapping out similar cabling.

## Examples of Troubleshooting Procedures

**IF** the **FAULT** light is **ON** and  
“**FLT OTSC**” is displayed

### **THEN**

Replace the coax cable

**IF** the **FAULT** light stops **AND** “**FLT OTSC**” is  
no longer displayed, **THEN** the problem has been  
resolved.

But, **IF** the **FAULT** light remains **ON** and  
“**FLT OTSC**” remains displayed, contact GPS Source.  
Technical Support.

**IF** the **FAULT** light is **ON** and  
“**FLT LG**” is displayed

### **THEN**

The Receive Antenna has too little gain. Check the  
installation and installation requirements. Consider  
the line of sight on the roof. Also, consider the type  
and quality of cable. Is it appropriate and is it working  
correctly. If installation is not correct, make proper  
adjustments and restart the GLI-METRO.

### **THEN**

**IF** the installation is correct or Receive Antenna and  
cable meets requirements, replace the Receive Antenna  
and/or the cable (or both) and restart the GLI-METRO.

**IF** the **FAULT** light stops **AND** “**FLT LG**” is no longer  
displayed, **THEN** the problem has been resolved.

But, **IF** the **FAULT** light remains **ON** and  
“**FLT OTSC**” remains displayed, contact GPS Source.  
Technical Support.

**IF** the **FAULT** light is **ON** and  
“**FLT LT4S**” is displayed

### **THEN**

Ensure the receive antenna has a clear view of the sky,  
restart system and wait 4 minutes.

**IF** receive antenna has clear view of sky, check satellite  
signal using a hand-held GPS receiver outside of  
building/structure.

**IF** hand-held GPS receiver is able to acquire 4 or more  
satellites, **THEN** replace the receive antenna, or cable  
or both and restart system.

**IF** the hand-held GPS receiver is **NOT** able to acquire  
4 or more satellites, there is an issue with interference or  
view of the constellation from the area.

**IF** hand-held GPS receiver is able to acquire 4 or more  
satellites and Receive Antenna and cable have been  
replaced and **FLT LT4S** still displayed, Contact GPS  
Source Technical Support.

## GPS SMART CONTROLLER FAULT CODES

This section describes fault codes and possible causes.

CODE	POSSIBLE CAUSE	SOLUTION
<b>FLT ENOS</b>	No satellites with adequate signal received during the en route operation	Receive antenna no longer has a clear view of the sky OR there is interference
<b>FLT GRX</b>	GPS Receiver Failure	GPS Receiver inside GLI-METRO unit has malfunctioned
<b>FLT HG</b>	High Gain detected at the input	Receive antenna hooked up directly to the GLI-METRO without the 100' coaxial cable OR Malfunctioning Receive antenna
<b>FLT INOC</b>	Input Open Circuit detected	Receive antenna or cable not connected to the GLI-METRO OR Cable/antenna has malfunctioned
<b>FLT OTOC</b>	Output Open Circuit detected	Passive antenna or cable not connected to the GLI-METRO OR Cable/antenna has malfunctioned
<b>FLT INSC</b>	Input short circuit detected	Receive cable is pinched/bent/broken OR Antenna has malfunctioned
<b>FLT OTSC</b>	Output short circuit detected	Output cable is pinched/bent/broken OR Antenna has malfunctioned
<b>FLT LG</b>	Low Gain detected at the input	Receive antenna/cable is incorrect (a passive transmit antenna may have been accidentally used in place of an active receive antenna)
<b>FLT LT4S</b>	Less than 4 satellites with adequate signal received after completion of initialization/acquisition	Receive antenna does not have a clear view of the sky OR there is interference

CODE	POSSIBLE CAUSE	SOLUTION
<b>FLT OC*</b>	Oscillation Condition detected	Transmit and receive antennas are pointed in each other's direction OR Power level is set to too high
<b>FLT PNOS</b>	No satellite with adequate signal received within 4 minutes from power on	Transmit and receive antennas are pointed in each other's direction OR Power level is set to too high
<b>FLT RFL1</b>	Failure in the L1 RF path	Power level is too high
<b>FLT RFL2</b>	Failure in the L2 RF path	L2 offset is too low OR Power level is too high
<b>RR LRU</b>	Non-recoverable system error detected – Repair/Replace GPS Smart Controller	Internal system malfunction e.g. memory

\*There are two different states where the Metro reports an OC fault. The first is during power on state before the GPS receiver has acquired satellites and it detects a noise level above a high threshold. The second is after satellites are tracking i.e. operational state and it sees noise above a high threshold and the receiver reports degraded SNR.

## Glossary of Terms

**Accuracy:** How close a fix comes to the actual position.

**Acquisition:** The ability to find and lock on to satellite signals for ranging.

**Active Antenna:** An antenna with an amplifier or an amplified antenna – What defines an “active” GPS antenna is the inclusion of a Low Noise Amplifier (LNA). The LNA is necessary to make up for the signal loss that is inherent in all antenna cables. Active antennas require power from the GPS receiver to power the LNA. This power is obtained through the receiver’s external antenna jack. Because active antennas run off of the GPS receiver’s power, this puts extra drain on the receiver’s batteries. Most receivers detect the presence of an active antenna by the load (current drain) and automatically switch off the internal antenna providing the load is above a certain point.

**Amplifier (GPS):** The GPS signal is inherently weak. An amplifier will increase the power of a GPS signal, so that it can move through longer cable lengths that are used between the antenna and the GPS receiver.

**Antenna (GPS):** A GPS antenna is a device that helps boost the reception signal to a GPS unit, whether it is a standalone unit or an embedded unit. Often a GPS antenna is used in a situation where the GPS unit itself is somehow removed from a line of sight to the sky, as in a building, to help the GPS “see” the sky without having to be moved.

**Antenna Monitor:** For an active GPS active antenna ,performance monitoring is accomplished by monitoring the amount of current the antenna preamplifier consumes, as most problems manifest by either a marked increase or decrease in antenna preamplifier current draw, i.e. too much current indicates a short and too little indicates an open circuit. For a passive antenna this is accomplished in the same fashion but the passive antenna will have a resistor network that draws current instead of a preamplifier

**Attenuator:** A component used to make the GPS signal smaller by a predetermined amount, which is measured in decibels. They can be of two categories: fixed and variable.

**Bandwidth:** The range of frequencies in a signal.

**BIT:** Acronym for Built-In-Test. It is a design that permits a device to test itself

**Bluetooth:** A standard of radio technology that makes it possible to transmit signals over short distances between telephones, computers and other devices.

**BNC:** A type of GPS antenna connection

**Coax Cable:** An electrical cable with an inner conductor surrounded by a flexible, tubular insulating layer, surrounded by a tubular conducting shield.

**dBm:** An abbreviation for the power ratio in decibels (dB) of the measured power referenced to one milliwatt (mW).

**dB-Hz:** Unit of measure for carrier-to-noise density ratio, C/N0. It is a measure of the power density in 1 Hz bandwidth.

**Decibel:** A mathematical conversion utilizing logarithms of a ratio, which is used as a unit of measure for RF signals. It is primarily used as a measure of the (power) gain and (insertion) loss of RF components.

**DC Feedthrough:** A design allowing the DC present on the GPS receiver to be fed to the active antenna.

**ERP:** Acronym for Effective Radiated Power. It is a standardized theoretical measurement of GPS energy and is determined by subtracting system losses and adding system gains.

**FAULT LED:** Indicates the status of the automated Built In Test (BIT) functionality of the GLI-METRO. If FAULT is illuminated, there exists some anomaly within the GLI-METRO which will be shown on the display.

**Filters:** A passive GPS component which passes or rejects a signal solely on the basis of its frequency. There are four main categories of filters: low pass, high pass, bandpass and band reject.

**Firmware:** Lies between software and hardware. Firmware is programming code, but it is stored on a chip or other hardware within the GPS device, and it functions only within the context of the chip/hardware in which it resides.

**Fix:** Defining position, where two lines such as latitude and longitude cross, as determined by one or more navigation aids or techniques.

**Frequency:** The number of waves passing a specific point within a unit period of time, expressed in Hertz (cycles per second).

**Frequency band:** A particular range of frequencies.

**Frequency Modulation:** A method of encoding information about a carrier signal by altering the frequency while amplitude remains constant.

**Gain:** The increase in size of the output signal of an amplifier with respect to the input signal. It is measured in decibels.

**Gimbal Mount:** A gimbal mount is defined as a mount whose axes of rotation are orthogonal and fixed in space. (GPS Source often refers to a gimbal mount as a "Panavise").

**GPS:** A system for providing precise location which is based on data transmitted from a constellation of 24 satellites - (Global Positioning System) - A system of 24 satellites used to locate any point on the earth by triangulation and distance measuring.

**GPS Splitter (Power Divider):** A passive device which equally divides a GPS signal into two or more signals.

**GPS Smart Controller:** Also known as the GLI-METRO. It receives the GPS L1 (L1/L2 optional) from an active antenna. A power control function measures the output power of the GPS signal from the device and controls the gain. It may be combined with GPS splitters and retransmission antennas to cover a large area.

**High Gain Amplifier:** A high gain GPS amplifier allows for long cables lengths (up to 350 meters) to be used.

**Insertion Loss:** The loss a signal experiences as it travels through a passive component (for example, signal traveling through cabling will experience an insertion loss)

**Isolation:** No unwanted signals are transmitted between ports. It is a measure of the insertion loss in the "open" path of an RF switch, or between any two ports in a passive RF component. Like insertion loss, it is measured in decibels.

**Interference:** Any distortion of the transmitted signal that impedes the reception of the signal at the receiver (same as noise).

**L-band:** The group of radio frequencies extending from 390 MHz to 1550 MHz. The GPS carrier frequencies (1227.6 MHz and 1575.42 MHz) are in the L-band.

**L1 signal:** The primary L-band signal transmitted by each GPS satellite at 1572.42 MHz.

**L2 signal:** The second L-band signal is centered at 1227.60.

**Lightning Protection:** A system designed to protect a structure from damage due to lightning strikes by intercepting such strikes and safely passing their extremely high voltage currents to "ground". Most lightning protection systems include a network of lightning rods, metal conductors, and ground electrodes designed to provide a low resistance path to ground for potential strikes.

**Low Noise Amplifier (LNA):** A powered amplifier used to amplify the GPS signals (for example, captured by an antenna). It is usually located very close to the detection device (antenna) to reduce losses in the cable.

**MCX:** A type of GPS antenna connection.

**Multipath Error:** Errors caused by the interference of a signal that has reached the receiver antenna by two or more different paths. This is usually caused by one path being bounced or reflected.

**N:** A type of GPS antenna connection

**Noise:** Any unwanted changes to an RF signal. With GPS, it can be any unwanted disturbances, superimposed on a signal, that tend to obscure a signal's usefulness.  
or information content.

**Reverse Isolation:** Reverse isolation of an amplifier means no unwanted signals that may be on the GPS device are transmitted back to the GPS antenna.



**Oscillation:** To move in a repeated back and forth motion.

**Passive Antenna:** An antenna that does not include an LNA and therefore does not require power. Also known as a transmitting antenna.

**Power Level:** See ERP (Effective Radiated Power)

**Receiver (GPS):** A piece of equipment that is used by the civilians and the military to pick up satellite signals that contain data in order to locate position.

**Reradiating:** When the GPS signal is brought into a structure via an active antenna/coax cable and transmitted inside through a passive antenna.

**RS232:** The most known serial port used in transmitting the data in communication and interface. Even though serial port is harder to program than the parallel port, this is the most effective method in which the data transmission requires less wires that yields to the less cost. The RS232 is the communication line which enables the data transmission by only using three wire links. The three links provides 'transmit', 'receive' and common ground

**SMA:** A type of GPS antenna connection

**SNR (signal to noise ratio) Signal to Noise Ratio:** A measure of the information content of the signal relative to the signal's noise. A higher number is desirable.

**TNC:** A type of GPS antenna connection

**Transmitter:** One of the 2 main building blocks in a wireless system which is responsible for taking the signal from the modulator, increasing its frequency and power, then radiating it out the antenna.

**TTFF:** -Time To First Fix - The time it takes for a GPS receiver to lock onto the satellite signals and determine the initial position

**User interface:** The way a receiver conveys information to the person using it. The controls and displays of a device.

**Variable Gain Amplifier:** An amplifier with an external control which is used to vary its gain.

**XMIT:** Acronym for "Transmit" or "Transmitter"

