



Test Report No. 9312329195

For Radwin Ltd

Equipment Under Test:

***3.6 GHz Transceiver.
Radio module AP0136450***

***From The Standards Institution
Of Israel
Industry Division
Electronics & Telematics Laboratory
EMC Branch***



Test report No: 9312329195

Page 2 of 70 Pages

Title: 3.6 GHz Transceiver.

Model: Radio module AP0136450 FCC ID: Q3KRW3XMOD/ IC: 5100A-RW3XMOD

Table of Contents

1. Applicant information	3
2. Test performance	3
3. Summary of test:	4
4. Equipment under test description	5
4.1. General description.	5
4.2. EUT and test setup block diagrams.	6
5. Test results:	8
5.1. Transmitter characteristics.	8
5.1.1. Emission bandwidth and power limitation according to §§ 90.321, 2.1049	8
5.1.2. EIRP output power test § 90.1321(a)	13
5.1.3. Peak EIRP power density test § 90.1321(a)	22
5.1.4. Spurious and band edge emission conducted § 90.1323, RSS -197 section 5.7	31
5.1.5. Radiated emissions test according to §§ 90.1323, 2.1053, RSS-197	44
5.1.6. Frequency stability test according to § 2.1055, RSS-197 section 5.3	57
6. Receiver characteristics test.	58
6.1. Receiver spurious emissions test at antenna terminal according to RSS -197 section 5.8	58
6.2. Receiver spurious emissions radiated according to RSS -197 section 5.8	60
7. APPENDIX A Photographs and additional information.	62
8. APPENDIX B Test equipment used	65
9. APPENDIX C Abbreviations and acronyms	70



Test report No: 9312329195

Page 3 of 70 Pages

Title: 3.6 GHz Transceiver.

Model: Radio module AP0136450 **FCC ID:** Q3KRW3XMOD/ **IC:** 5100A-RW3XMOD

1. Applicant information

Order placed by:	Radwin Ltd
Address:	27 Habarzel str, Tel-Aviv, 6971039, Israel
Sample for test selected by:	The customer
The date of test:	August 2013

Equipment under test information

Description of Equipment Under Test (EUT):	3.6 GHz Transceiver.
Model:	Radio module AP0136450
Serial Number:	NA
Manufactured by:	Radwin Ltd.

2. Test performance

Location:	SII EMC Branch
Purpose of test:	Apparatus compliance verification in accordance with emission requirements
Test specifications:	47CFR part 90Z, part 2 §§ 2.1049, 2.1055, part 1 §1.1310, IC RSS – 197.

This Test Report contains 70 pages and may be used only in full.

This Test Report applies only to the specimen tested and may not be applied to other specimens of the same product.



Test report No: 9312329195

Page 4 of 70 Pages

Title: 3.6 GHz Transceiver.

Model: Radio module AP0136450 FCC ID: Q3KRW3XMOD/ IC: 5100A-RW3XMOD

3. Summary of test:

The EUT was found to be in compliance with requirements of: 47CFR part 90 §§ 90.1321, 90.1323 part 2 and IC RSS – 197.

Parameter	Subclasses
Transmitter characteristics	
Emission bandwidth	2.1049, IC RSS-197 sec. 5.2
EIRP band power	90.1321(a)/RSS- 197 sec. 5.6
Peak EIRP power density	90.1321(a)/ /RSS- 197 sec. 5.6
Spurious emissions at antenna terminal	90.1323//RSS- 197 sec. 5.7
Spurious emissions radiated	90.1323/RSS- 197 sec. 5.7
Frequency stability test	2.1055/RSS- 197 sec. 5.3
Receiver spurious emissions at antenna terminal.	RSS – 197 section 5.8
Receiver spurious emissions radiated.	RSS – 197 section 5.8

Electronics &
Telematics
Laboratory

October 2013

Name: Eng. Yuri Rozenberg
Position: Head of EMC Branch

Name: Michael Feldman
Position: Test Technician

Measurement uncertainty.

Were relevant, the following measurement uncertainty level have been estimated for tests performed on the EUT as specified in CISPR 16-4-2:

This uncertainty represents an expended uncertainty expressed at approximately the 95% confidence level using a coverage factor of k=2.

Test description	Expanded uncertainty
<p><u>Radiated emissions</u> in the open field test site at 3 m measuring distance: 30 MHz – 1.0 GHz 1.0 GHz – 18 GHz</p>	<p>2 Uc (E) = ± 4.32 dB 2 Uc (E) = ± 4.47 dB</p>



Test report No: 9312329195

Page 5 of 70 Pages

Title: 3.6 GHz Transceiver.

Model: Radio module AP0136450 **FCC ID:** Q3KRW3XMOD/ **IC:** 5100A-RW3XMOD

4. Equipment under test description

*The customer provided description.

4.1. General description.

The AP0136450 module is a Point to Point /Point to Multipoint 2x2 MIMO high power transceiver designed for various outdoor enclosures manufactured and assembled by RADWIN Ltd. The EUT operates in 5, 10, 20, 40 MHz channel bandwidths in the frequency range 3650-3700 MHz complying FCC and IC regulations. It is using OFDM transmission technique in TDD duplexing method.

The power is provided through the digital board and is internally regulated. The external power to the ODU is provided by a PoE adaptor or indoor unit.

The EUT support various types of cross-polarized antennas connected through the N-Type connectors or directly to SMA interface.

EUT technical characteristics

Technical characteristics of transmitter.		Note
Stand-alone/ fixed use	Always at distance at least 2 m from the people and public area.	
Assigned frequency range	3650 – 3700 MHz	-
Declare frequency range	3652.5 – 3697.5 MHz	-
Operating frequency range	3652.5 – 3697.5 MHz	5 MHz EBW
	3655 – 3695 MHz	10 MHz EBW
	3660 – 3690 MHz	20 MHz EBW
	3670 - 3680 MHz	40 MHz EBW
Declare maximum conducted power	22 ±1 dBm per chain.	
Antenna connection	N-Type connector	Professional installation
Transmitter declares bandwidths.	5, 10, 20, 40 MHz	
Type of modulation	BPSK, QPSK, 16QAM, 64QAM	
Type of multiplexing	OFDM	
Modulating test signal	PRBS	
Transmitter duty cycle supplied for test	100 %	
Antenna information		
*Antenna Type	Manufacturer	Model
**External Sector Dual Pole 90Deg	RADWIN Ltd.	RW-9061-3001
		Gain, dBi
		14

*Full list of used antennas and them characteristics available in User Manual.

List of some antennas used by applicant available in Appendices

** External antenna assembly gain (with external cable) will be reduced by 2 dB.

Test report No: 9312329195

Page 6 of 70 Pages

Title: 3.6 GHz Transceiver.

Model: Radio module AP0136450 FCC ID: Q3KRW3XMOD/ IC: 5100A-RW3XMOD

4.1.1 Environmental evaluation and exposure limit according to FCC § 90.1335, part 1, §1.1307(b) and IC RSS – Gen section 5.5.

Power density limit in 3650 – 3700 MHz band for general population/uncontrolled exposure is 1(mW/cm²).

The power density calculation is $S = (Pt / 4\pi r^2)$.

Where:

Pt - The transmitted power (EIRP) (mW)

r - The distance from the unit. (cm)

The 1(mW/cm²) limit can be calculated from the above based on the following data:

Pt- the maximum allowed transmitted EIRP power = 46.1 dBm = 40738 mW.

Minimum allowed RF safety distance “r”, where RF exposure limit may not be exceeded = $\text{SQRT}(40738/4\pi)$ and is more than 57 cm from the antenna main lobe.

4.2. EUT and test setup block diagrams.

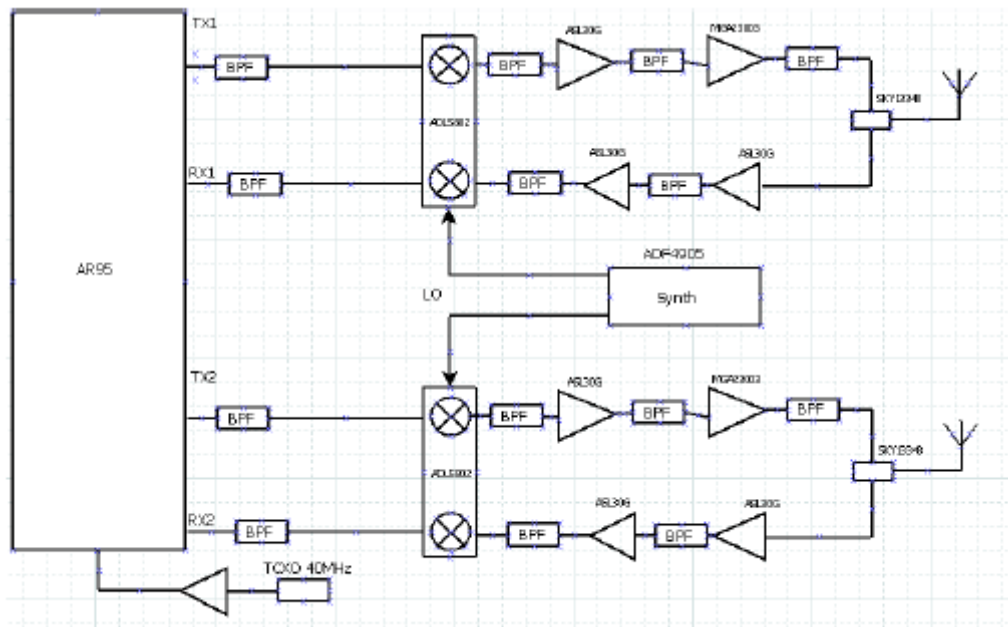

Fig. 1 AP0136450 radio module block diagram.

Test report No: 9312329195

Page 7 of 70 Pages

Title: 3.6 GHz Transceiver.

Model: Radio module AP0136450 **FCC ID:** Q3KRW3XMOD/ **IC:** 5100A-RW3XMOD

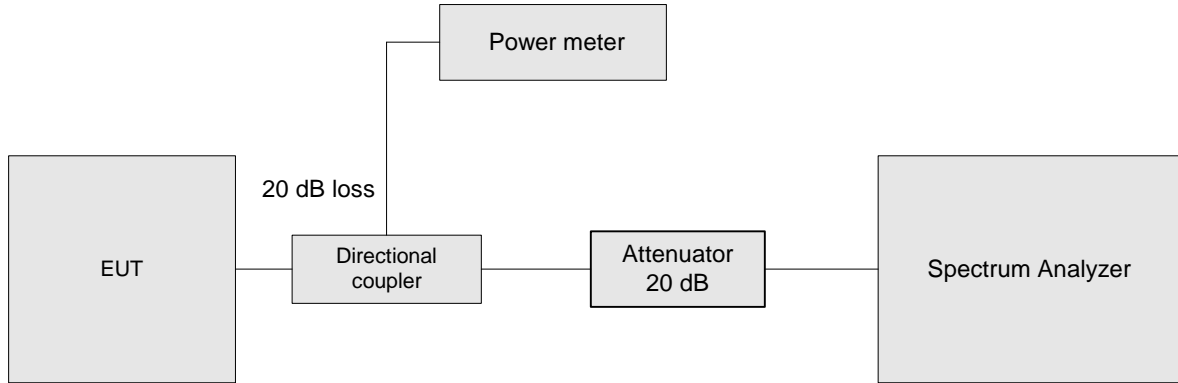

Fig. 2 Conducted measurements test setup.

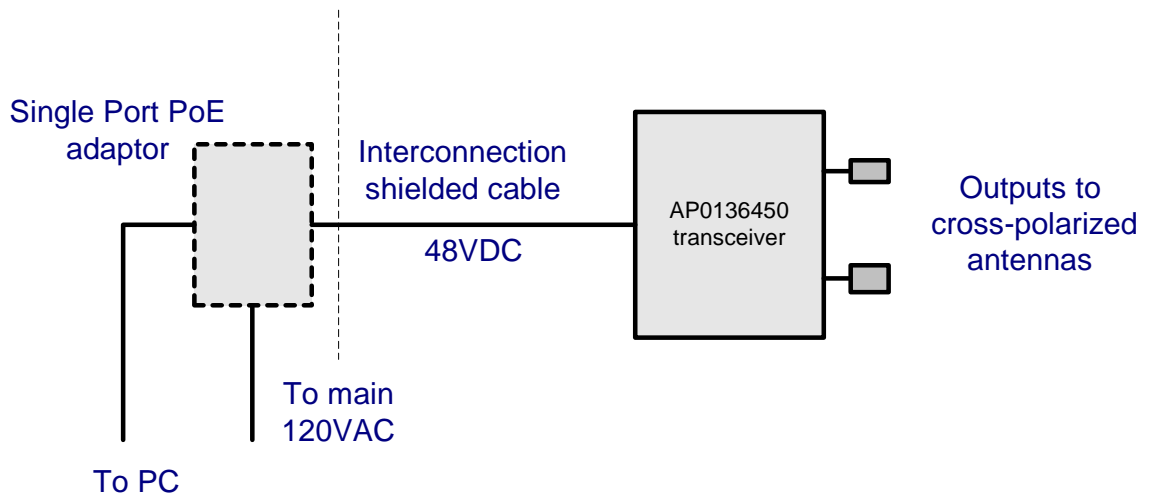

Fig. 3 Radiated measurements test setup.



Test report No: 9312329195

Page 8 of 70 Pages

Title: 3.6 GHz Transceiver.

Model: Radio module AP0136450 FCC ID: Q3KRW3XMOD/ IC: 5100A-RW3XMOD

5. Test results:

5.1. Transmitter characteristics.

5.1.1. Emission bandwidth and power limitation according to §§ 90.321, 2.1049.

Method of measurement § 2.1049, ANSI 63.4 § 13.7, **IC RSS-Gen**
 Operating Frequency Range 3652.5 – 3697.5 MHz
 Detector used RMS
 Resolution bandwidth 1 – 3% EBW
 Video bandwidth > RBW
 Output power setting Maximum allowed power.
 Ambient Temperature 24° C Relative Humidity 47% Air Pressure 1007 hPa

EBW, MHz	Carrier frequency, MHz	Type of modulation	*26 dBc emission bandwidth MHz	Specified power limit, dBm/EBW	Power limit for measured EBW, dBm	Reference to plot #	
						BPSK	64QAM
5	3652.5	BPSK/64QAM	5.06/5.06	37/5 MHz	37.0	1	2
	3675.0	BPSK/64QAM	5.05/5.08	37/5 MHz	37.0	3	4
	3697.5	BPSK/64QAM	5.04/5.06	37/5 MHz	37.0	5	6
10	3655	64QAM	9.8	40/10 MHz	39.9	7	
	3675	64QAM	9.7	40/10 MHz	39.9	8	
	3695	64QAM	9.7	40/10 MHz	39.9	9	
20	3660	64QAM	20.8	43/20 MHz	43.17	10	
	3675	64QAM	21.0	43/20 MHz	43.21	11	
	3690	64QAM	21.0	43/20 MHz	43.21	12	
40	3670	64QAM	40.7	46/40 MHz	46.07	13	
	3675	64QAM	41.0	46/40 MHz	46.1	14	
	3680	64QAM	40.8	46/40 MHz	46.08	15	

*99% power emission bandwidth is > 1 MHz and complies with RSS-197 section 5.2 requirement.

TEST PROCEDURE

The EUT RF output was connected to the Spectrum Analyzer through appropriate attenuator and accounted with cable loss in SA settings.

Attenuation of external attenuator, directional coupler and cable insertion loss = 21.5 dB.



Test report No: 9312329195

Page 9 of 70 Pages

Title: 3.6 GHz Transceiver.

Model: Radio module AP0136450 FCC ID: Q3KRW3XMOD/ IC: 5100A-RW3XMOD

Emission bandwidth test.
5 MHz EBW option.

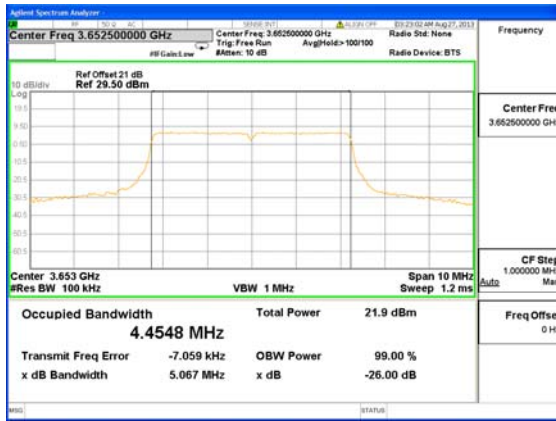

Plot # 1

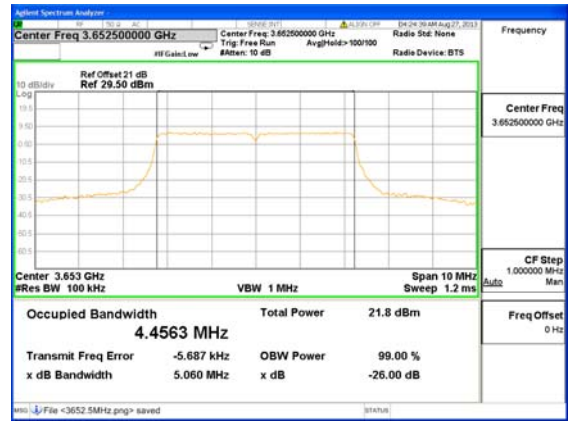

Plot # 2

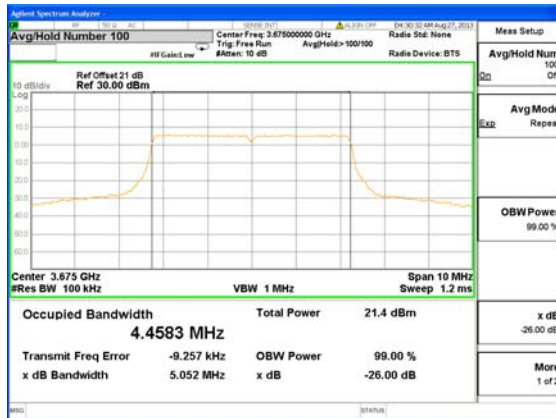

Plot # 3

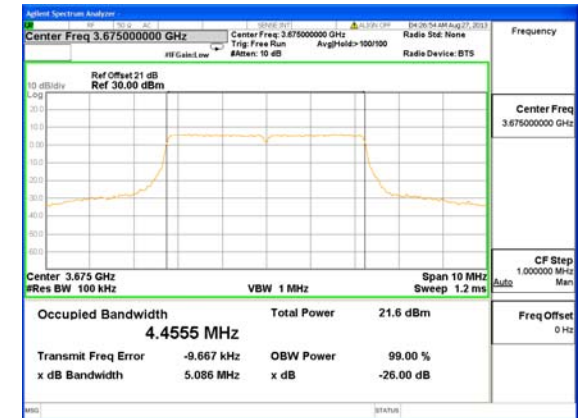

Plot # 4

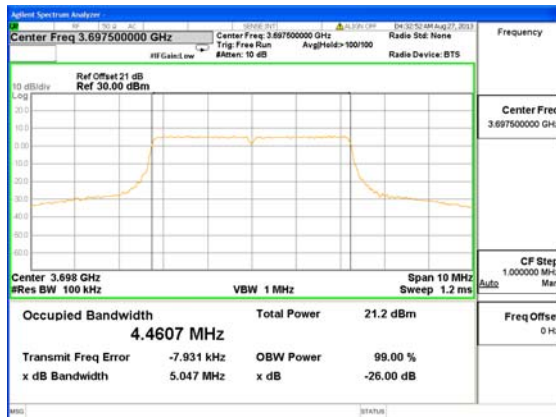

Plot # 5

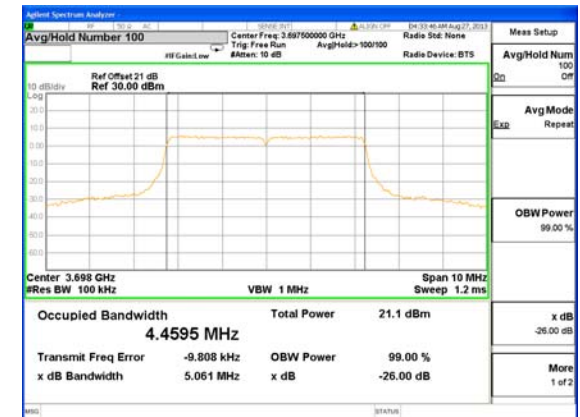

Plot # 6



Test report No: 9312329195

Page 10 of 70 Pages

Title: 3.6 GHz Transceiver.

Model: Radio module AP0136450 FCC ID: Q3KRW3XMOD/ IC: 5100A-RW3XMOD

10 MHz EBW option.

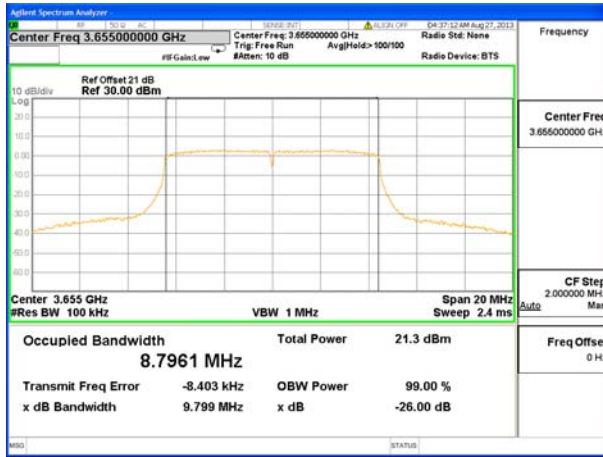

Plot # 7

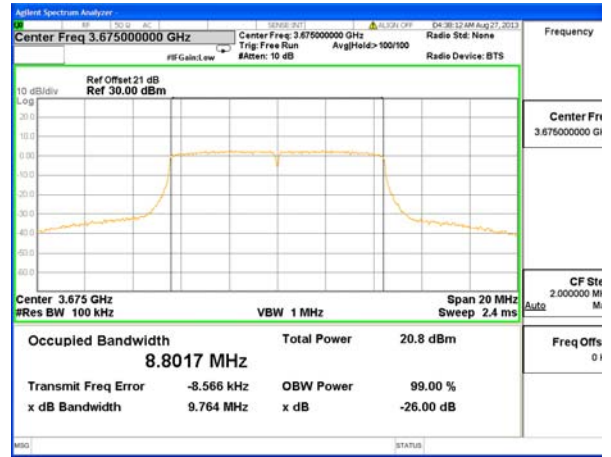

Plot # 8

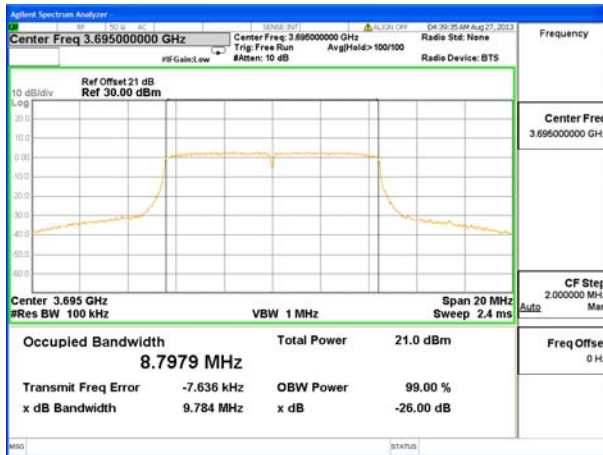

Plot # 9



Test report No: 9312329195

Page 11 of 70 Pages

Title: 3.6 GHz Transceiver.

Model: Radio module AP0136450 FCC ID: Q3KRW3XMOD/ IC: 5100A-RW3XMOD

20 MHz EBW option.

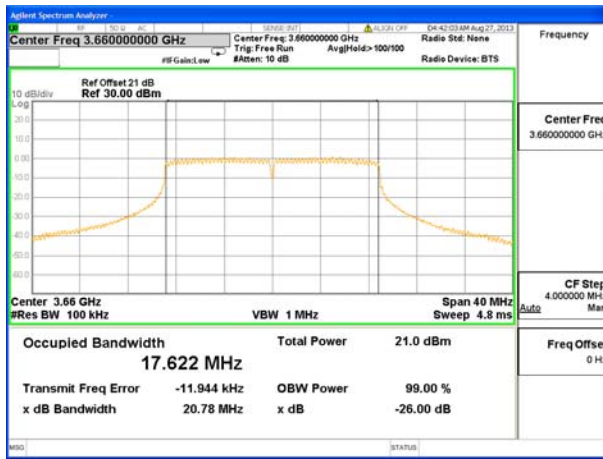

Plot # 10

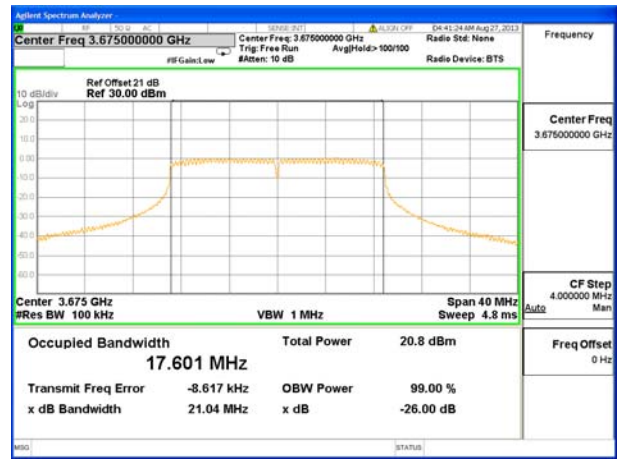

Plot # 11

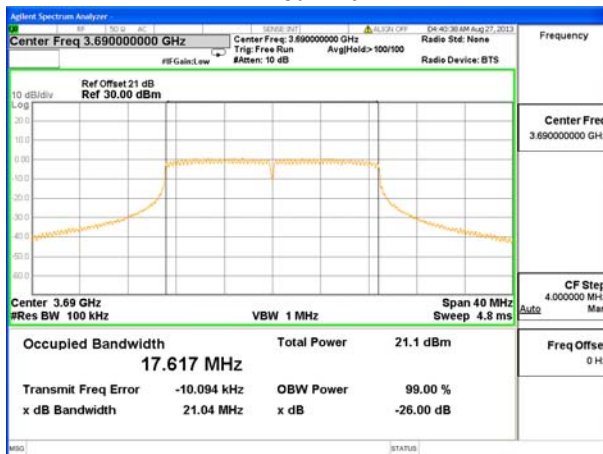

Plot # 12



Test report No: 9312329195

Page 12 of 70 Pages

Title: 3.6 GHz Transceiver.

Model: Radio module AP0136450 FCC ID: Q3KRW3XMOD/ IC: 5100A-RW3XMOD

40 MHz EBW option.

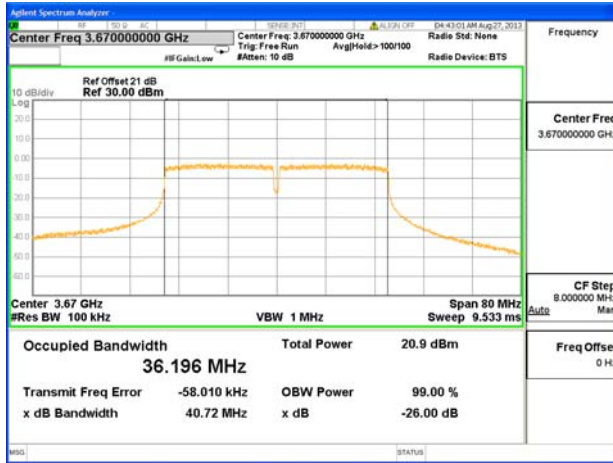

Plot # 13

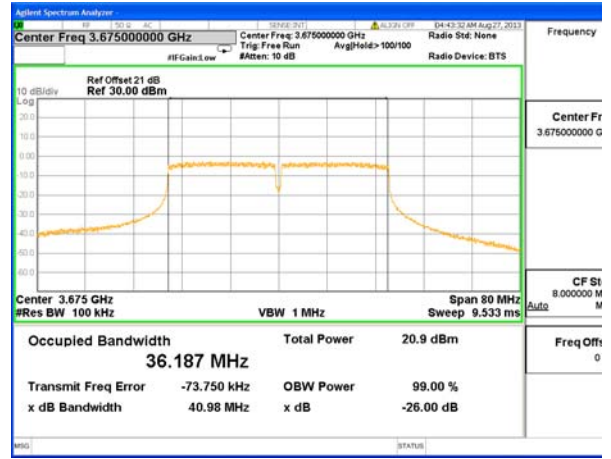

Plot # 14

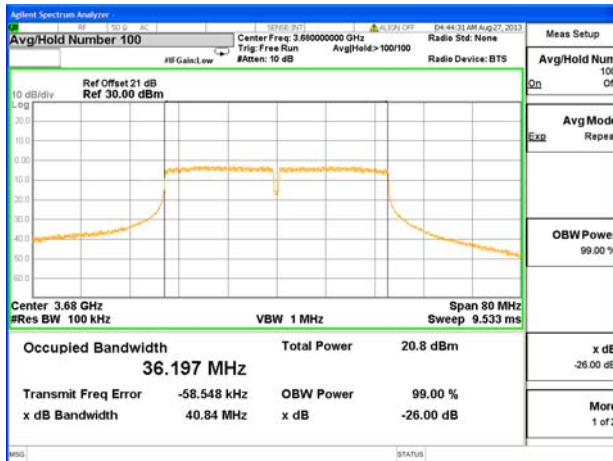

Plot # 15



Test report No: 9312329195

Page 13 of 70 Pages

Title: 3.6 GHz Transceiver.

Model: Radio module AP0136450 FCC ID: Q3KRW3XMOD/ IC: 5100A-RW3XMOD

5.1.2. EIRP output power test § 90.1321(a)

Method of measurement 965270 D01 Pwr. Meas. Part 90Z.
 Operating Frequency Range 3652.5 – 3697.5 MHz
 Detector used RMS
 Resolution bandwidth 1 – 3% EBW
 Video bandwidth > RBW
 Output power setting **Maximum allowed power.
 Ambient Temperature 24° C Relative Humidity 47% Air Pressure 1007 hPa

The following power limits apply to the 3650 – 3700 MHz band:
 Base and fixed stations are limited to 25 watts/25 MHz equivalent isotropically radiated power (EIRP).

EBW MHz	Carrier frequency, MHz	Type of modulation	Ch.1 output power, dBm	Ch.2 output power, dBm	Antenna assembly gain, dBi	*Total EIR power, dBm	EIRP limit, dBm	Verdict	Reference to plots #
5	3652.5	BPSK/ 64QAM	20.55/ 20.77	20.83/ 20.88	12	35.7/ 35.8	37.0	PASS	16/17 22/23
	3675.0	BPSK/ 64QAM	20.51/ 20.69	20.77/ 20.88	12	35.7/ 35.8	37.0	PASS	18/19 24/25
	3697.5	BPSK/ 64QAM	20.63/ 20.61	20.48/ 20.56	12	35.6/ 35.6	37.0	PASS	20/21 26/27
10	3655	64QAM	22.65	21.43	12	37.1	39.9	PASS	28/31
	3675	64QAM	22.65	21.17	12	37.0	39.9	PASS	29/32
	3695	64QAM	22.61	21.44	12	37.1	39.9	PASS	30/33
20	3660	64QAM	22.6	20.29	12	36.6	43.17	PASS	34/37
	3675	64QAM	22.77	20.12	12	36.5	43.21	PASS	35/38
	3690	64QAM	22.9	20.45	12	36.8	43.21	PASS	36/39
40	3670	64QAM	23.06	21.39	12	37.2	46.07	PASS	40/43
	3675	64QAM	22.88	21.22	12	37.2	46.1	PASS	41/44
	3680	64QAM	22.85	21.21	12	37.1	46.1	PASS	42/45

*The total EIRP = Sum of Ch.1 + Ch.2output powers (MIMO option) + Antenna assembly gain (12 dBi).

****Maximum allowed power is maximum produced by transmitter output power for minimum antenna assembly gain complies with EIRP, PSD and spurious emissions standard requirements. Actual power levels settings with respect to actual antenna assembly gain presents in User Manual.**



Test report No: 9312329195

Page 14 of 70 Pages

Title: 3.6 GHz Transceiver.

Model: Radio module AP0136450 FCC ID: Q3KRW3XMOD/ IC: 5100A-RW3XMOD

Output power test results.
5 MHz EBW option. Chain 1



Plot # 16



Plot # 17

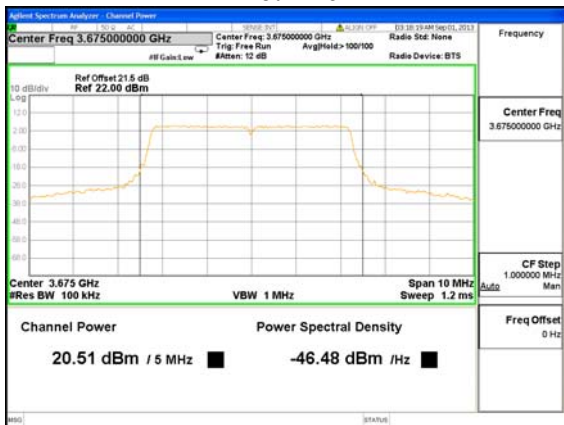

Plot # 18



Plot # 19



Plot # 20



Plot # 21



Test report No: 9312329195

Page 15 of 70 Pages

Title: 3.6 GHz Transceiver.

Model: Radio module AP0136450 FCC ID: Q3KRW3XMOD/ IC: 5100A-RW3XMOD

Chain 2



Plot # 22



Plot # 23



Plot # 24



Plot # 25



Plot # 26



Plot # 27



Test report No: 9312329195

Page 16 of 70 Pages

Title: 3.6 GHz Transceiver.

Model: Radio module AP0136450 FCC ID: Q3KRW3XMOD/ IC: 5100A-RW3XMOD

10 MHz EBW option. Chain 1.



Plot # 28

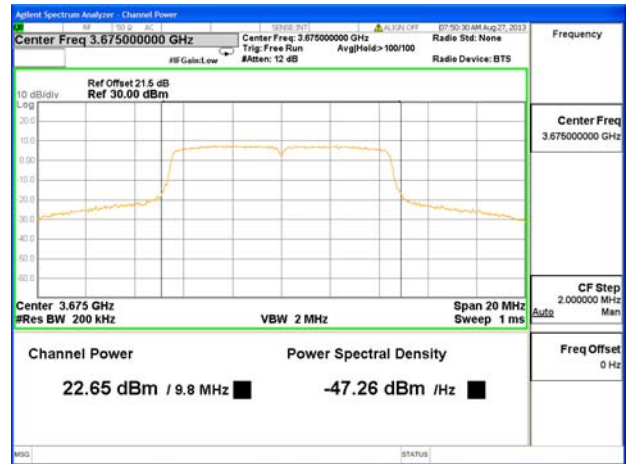

Plot # 29



Plot # 30



Test report No: 9312329195

Page 17 of 70 Pages

Title: 3.6 GHz Transceiver.

Model: Radio module AP0136450 FCC ID: Q3KRW3XMOD/ IC: 5100A-RW3XMOD

Chain 2.

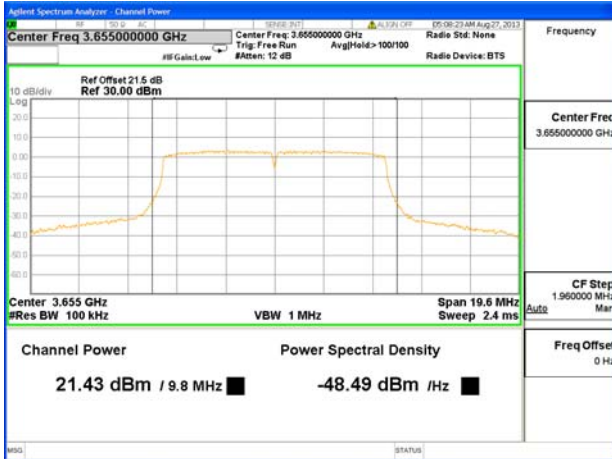

Plot # 31

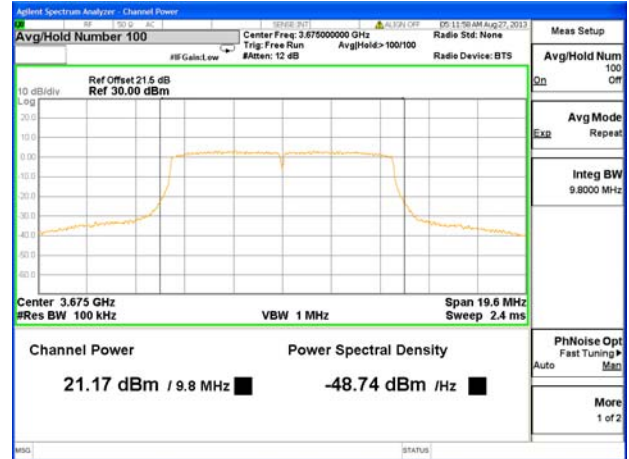

Plot # 32

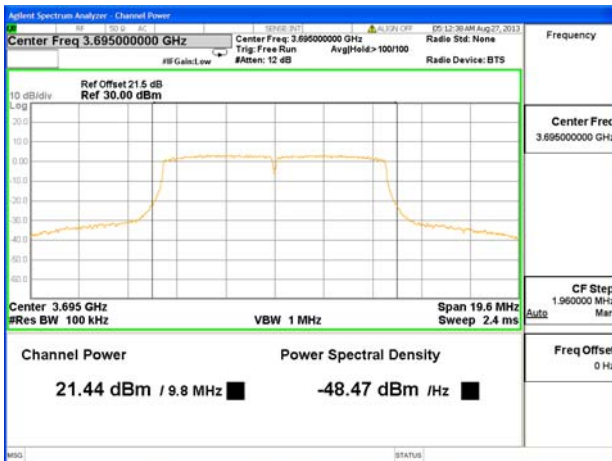

Plot # 33



Test report No: 9312329195

Page 18 of 70 Pages

Title: 3.6 GHz Transceiver.

Model: Radio module AP0136450 FCC ID: Q3KRW3XMOD/ IC: 5100A-RW3XMOD

20 MHz EBW option. Chain 1

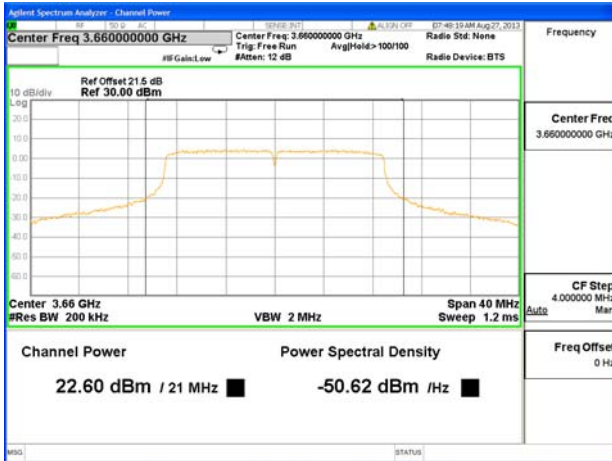

Plot # 34



Plot # 35

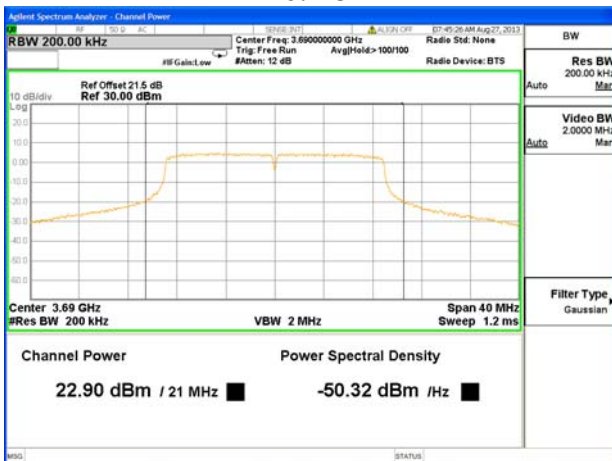

Plot # 36



Test report No: 9312329195

Page 19 of 70 Pages

Title: 3.6 GHz Transceiver.

Model: Radio module AP0136450 FCC ID: Q3KRW3XMOD/ IC: 5100A-RW3XMOD

Chain 2



Plot # 37



Plot # 38



Plot # 39



Test report No: 9312329195

Page 20 of 70 Pages

Title: 3.6 GHz Transceiver.

Model: Radio module AP0136450 FCC ID: Q3KRW3XMOD/ IC: 5100A-RW3XMOD

40 MHz EBW option. Chain 1.



Plot # 40

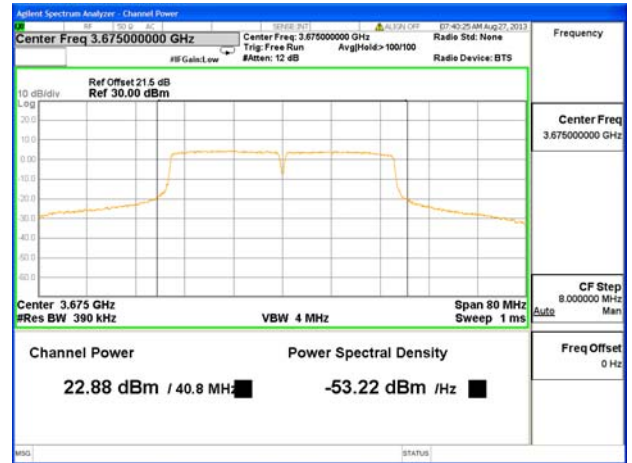

Plot # 41



Plot # 42



Test report No: 9312329195

Page 21 of 70 Pages

Title: 3.6 GHz Transceiver.

Model: Radio module AP0136450 FCC ID: Q3KRW3XMOD/ IC: 5100A-RW3XMOD

Chain 2.



Plot # 43

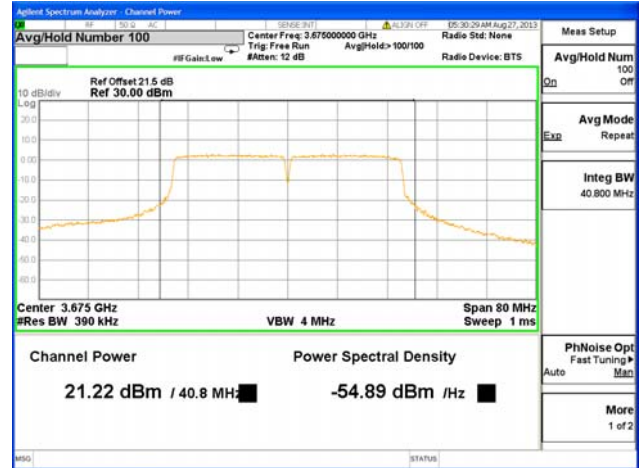

Plot # 44

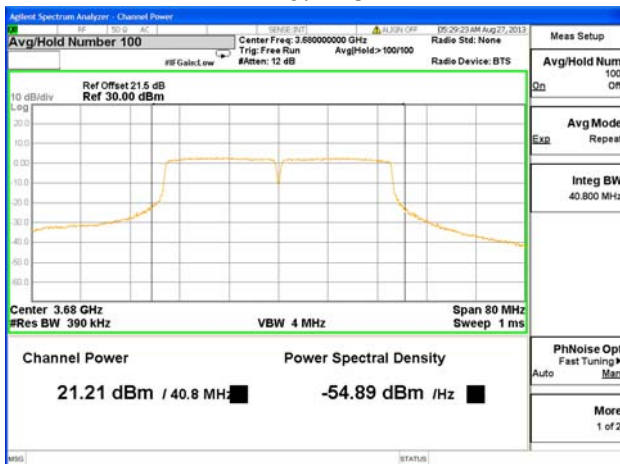

Plot # 45



Test report No: 9312329195

Page 22 of 70 Pages

Title: 3.6 GHz Transceiver.

Model: Radio module AP0136450 FCC ID: Q3KRW3XMOD/ IC: 5100A-RW3XMOD

5.1.3. Peak EIRP power density test § 90.1321(a)

Method of measurement 965270 D01 Pwr. Meas. Part 90Z.
 Operating Frequency Range 3652.5 – 3697.5 MHz
 Detector used RMS
 Resolution bandwidth 1 MHz
 Video bandwidth 3 RBW
 Output power setting Maximum allowed power.
 Ambient Temperature 24° C Relative Humidity 47% Air Pressure 1007 hPa

The following power limits apply to the 3650 – 3700 MHz band:
 Base and fixed stations are limited to 25 watts/25 MHz equivalent isotropically radiated power (EIRP). In any event, the peak EIRP power density shall not exceed 1 Watt in any one MHz slice of spectrum.

EBW MHz	Carrier frequency, MHz	Modul. type	Ch.1 PSD, dBm/MHz	Ch.2 PSD, dBm/MHz	*Total EIRP density, dBm/MHz	EIRP density limit, dBm/MHz	Verdict	Reference to plots #
5	3652.5	BPSK/64QAM	14.9/14.8	14.4/14.1	29.7/29.5	30	PASS	46/47 52/53
	3675.0	BPSK/64QAM	14.9/14.5	14.4/14.7	29.7/29.6	30	PASS	48/49 54/55
	3697.5	BPSK/64QAM	14.6/14.1	14.5/14.2	29.6/29.2	30	PASS	50/51 56/57
10	3655	64QAM	12.0	11.56	26.8	30	PASS	58/61
	3675	64QAM	11.67	12.3	27.0	30	PASS	59/62
	3695	64QAM	11.51	11.87	26.7	30	PASS	60/63
20	3660	64QAM	10.8	9.8	25.3	30	PASS	64/67
	3675	64QAM	11.1	9.48	25.4	30	PASS	65/68
	3690	64QAM	11.2	10.0	25.7	30	PASS	66/69
40	3670	64QAM	8.5	6.6	22.7	30	PASS	70/73
	3675	64QAM	8.3	8.87	23.6	30	PASS	71/74
	3680	64QAM	8.2	6.5	22.4	30	PASS	72/75

*The total EIRP density = Sum of Ch.1 + Ch.2 power densities (MIMO option) + Antenna assembly gain (12 dBi).



Test report No: 9312329195

Page 23 of 70 Pages

Title: 3.6 GHz Transceiver.

Model: Radio module AP0136450 FCC ID: Q3KRW3XMOD/ IC: 5100A-RW3XMOD

EIRP density test results.

5 MHz EBW option. Chain 1

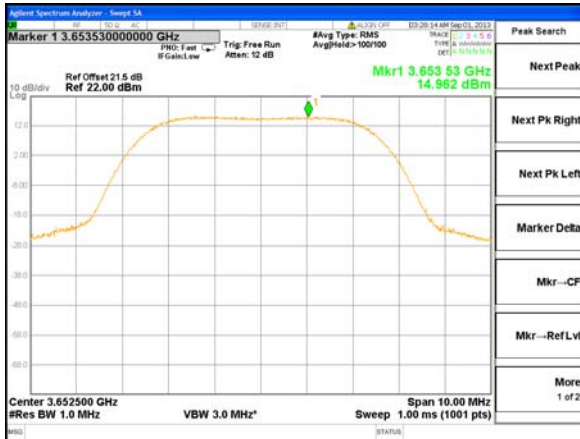

Plot # 46.

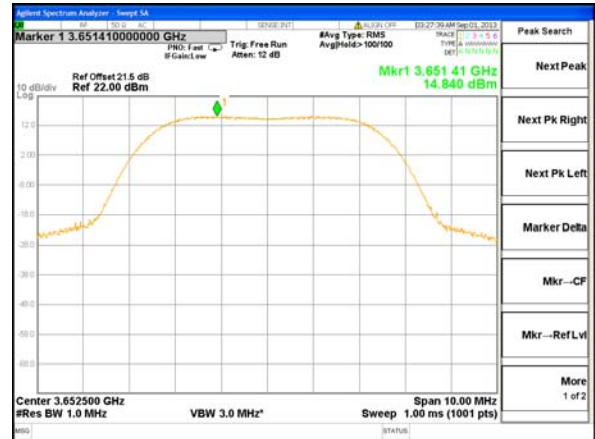

Plot # 47.



Plot # 48.

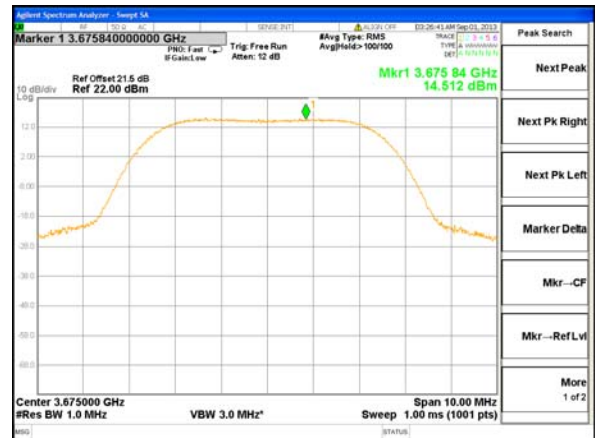

Plot # 49.



Plot # 50.

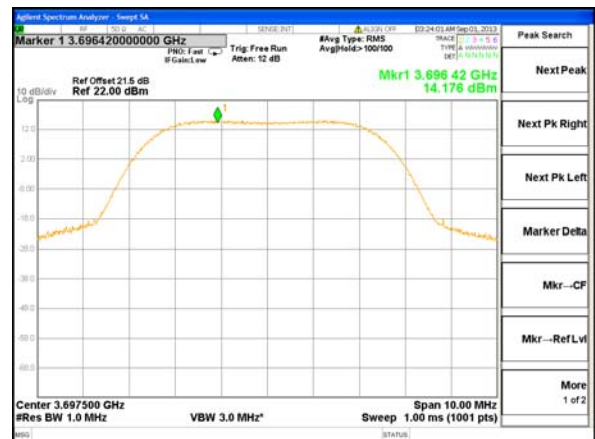

Plot # 51.



Test report No: 9312329195

Page 24 of 70 Pages

Title: 3.6 GHz Transceiver.

Model: Radio module AP0136450 FCC ID: Q3KRW3XMOD/ IC: 5100A-RW3XMOD

Chain 2

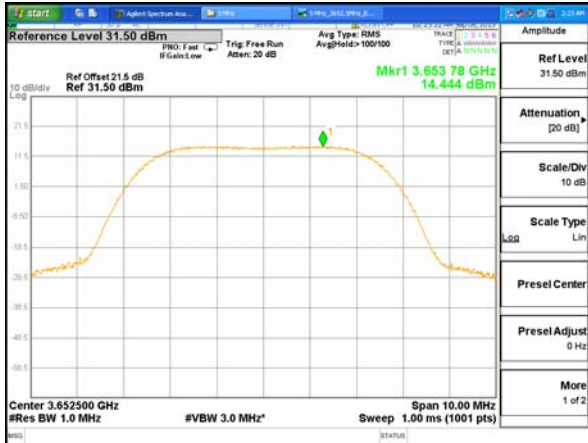

Plot # 52.



Plot # 53.

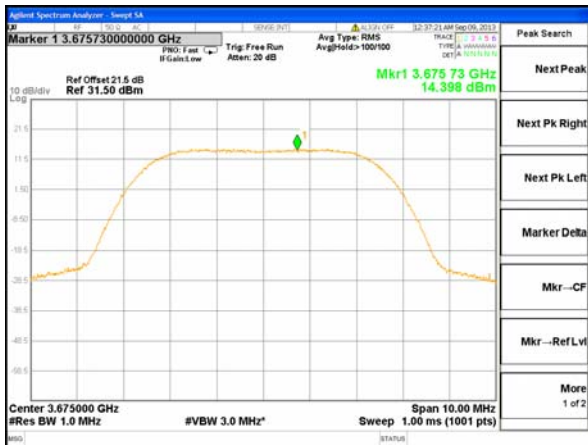

Plot # 54.

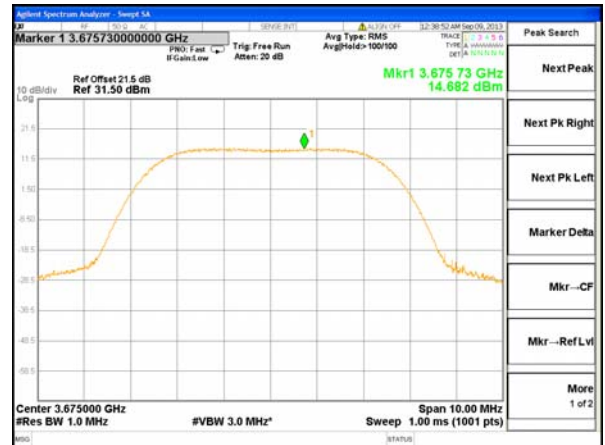

Plot # 55.

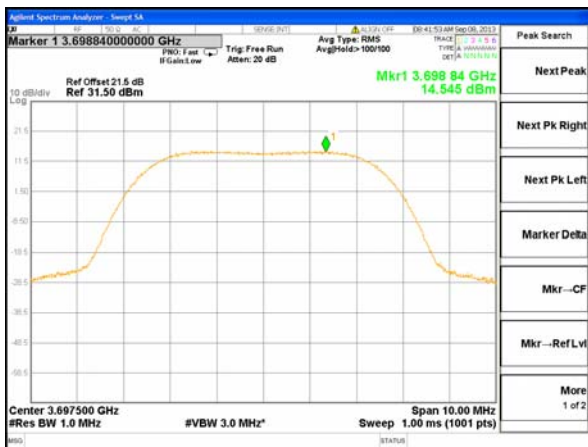

Plot # 56.

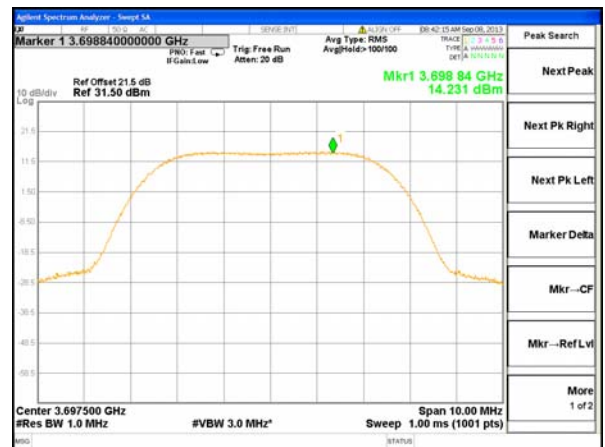

Plot # 57.



Test report No: 9312329195

Page 25 of 70 Pages

Title: 3.6 GHz Transceiver.

Model: Radio module AP0136450 FCC ID: Q3KRW3XMOD/ IC: 5100A-RW3XMOD

10 MHz EBW option. Chain 1



Plot # 58.

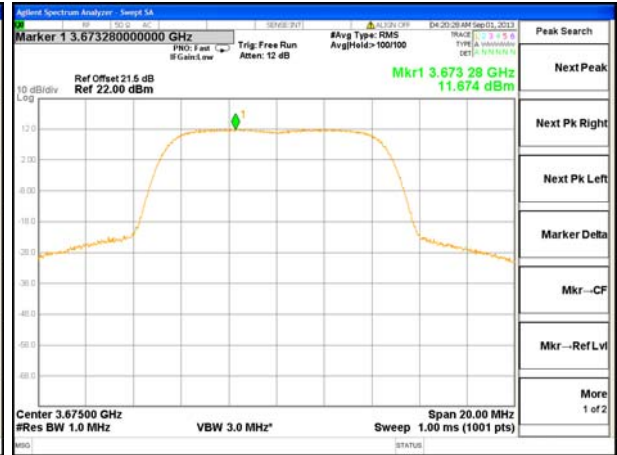

Plot # 59.



Plot # 60.



Test report No: 9312329195

Page 26 of 70 Pages

Title: 3.6 GHz Transceiver.

Model: Radio module AP0136450 FCC ID: Q3KRW3XMOD/ IC: 5100A-RW3XMOD

Chain 2

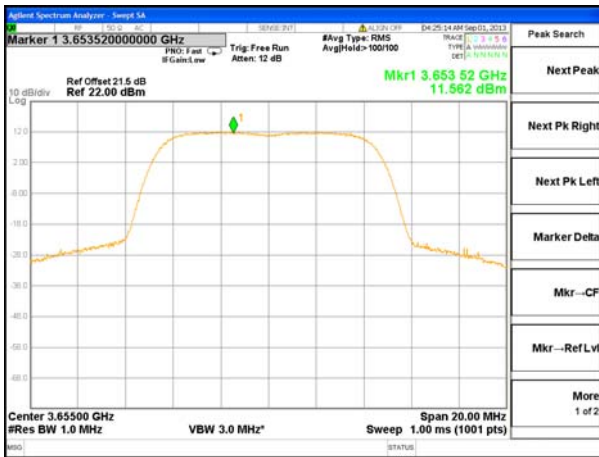

Plot # 61.

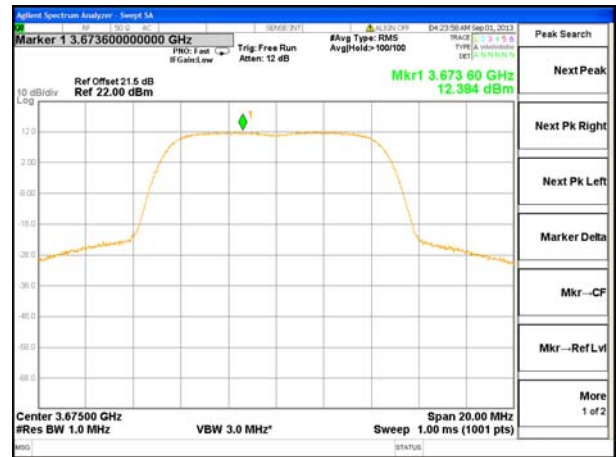

Plot # 62.

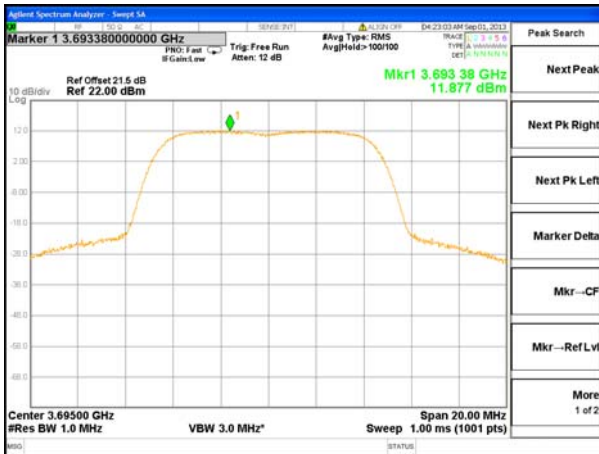

Plot # 63.



Test report No: 9312329195

Page 27 of 70 Pages

Title: 3.6 GHz Transceiver.

Model: Radio module AP0136450 FCC ID: Q3KRW3XMOD/ IC: 5100A-RW3XMOD

20 MHz EBW option. Chain 1

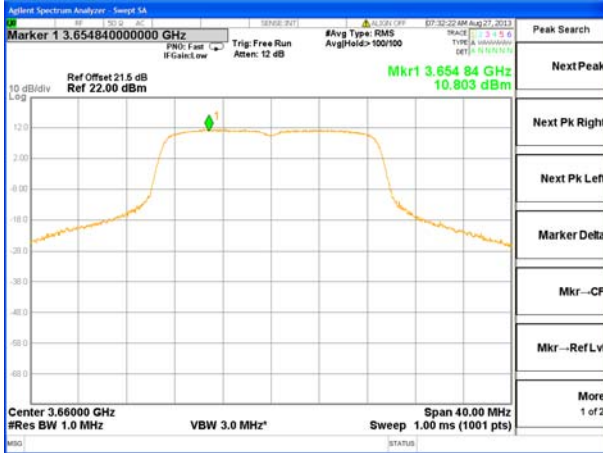

Plot # 64.

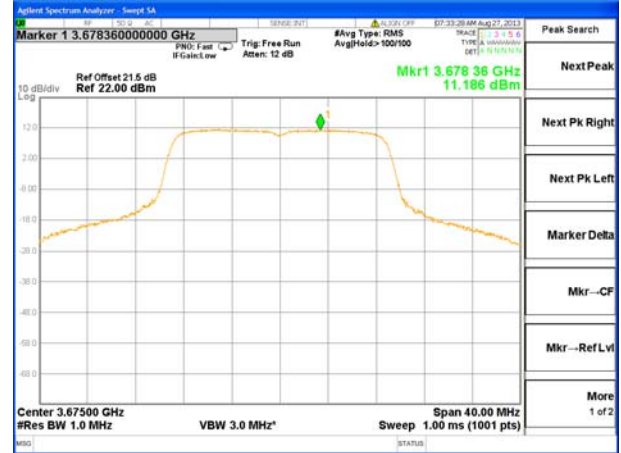

Plot # 65.

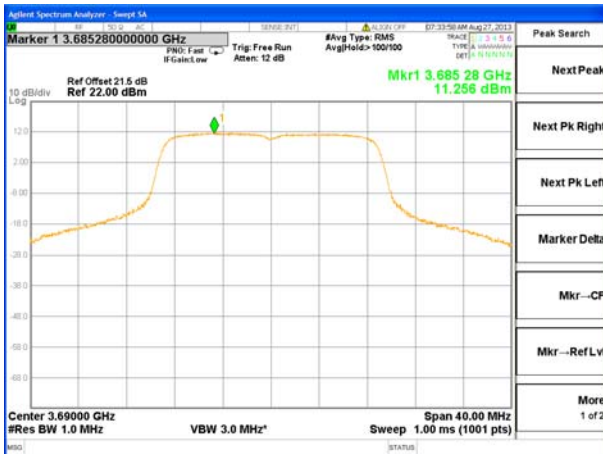

Plot # 66.



Test report No: 9312329195

Page 28 of 70 Pages

Title: 3.6 GHz Transceiver.

Model: Radio module AP0136450 FCC ID: Q3KRW3XMOD/ IC: 5100A-RW3XMOD

Chain 2

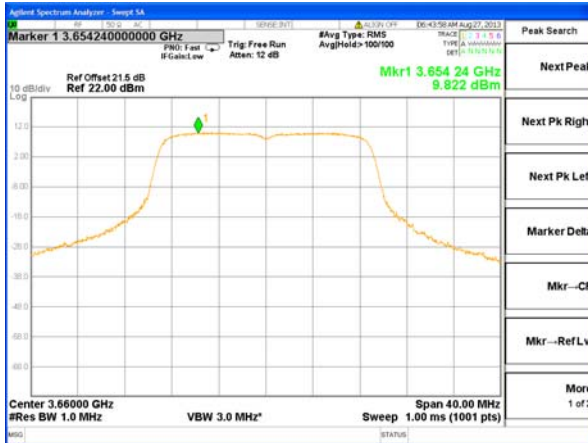

Plot # 67.

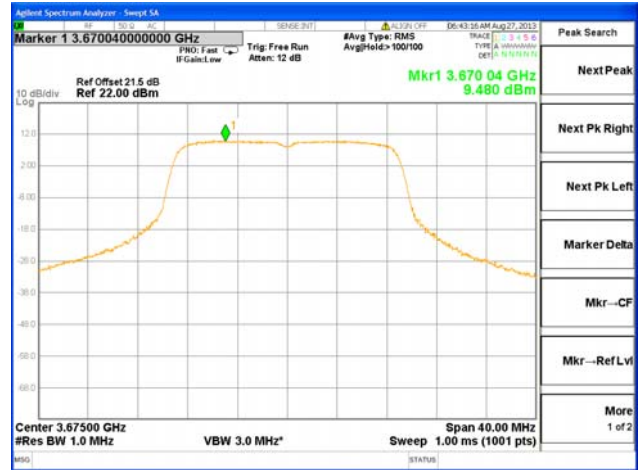

Plot # 68.

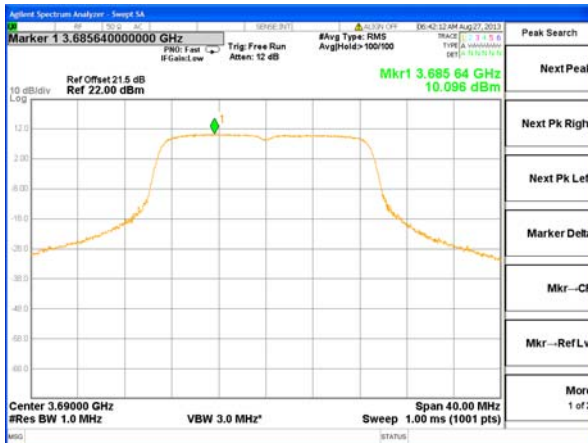

Plot # 69.



Test report No: 9312329195

Page 29 of 70 Pages

Title: 3.6 GHz Transceiver.

Model: Radio module AP0136450 FCC ID: Q3KRW3XMOD/ IC: 5100A-RW3XMOD

40 MHz EBW option. Chain 1

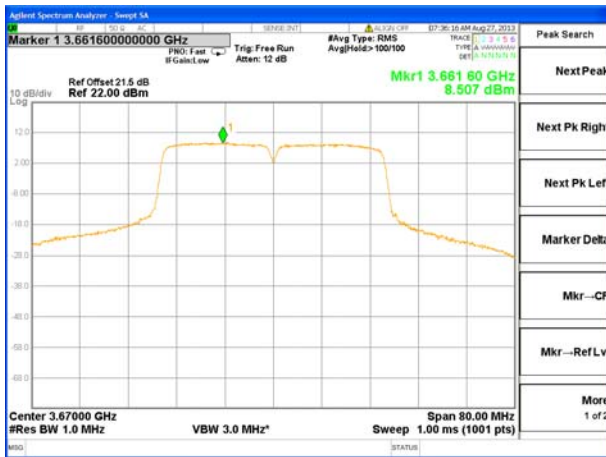

Plot # 70.

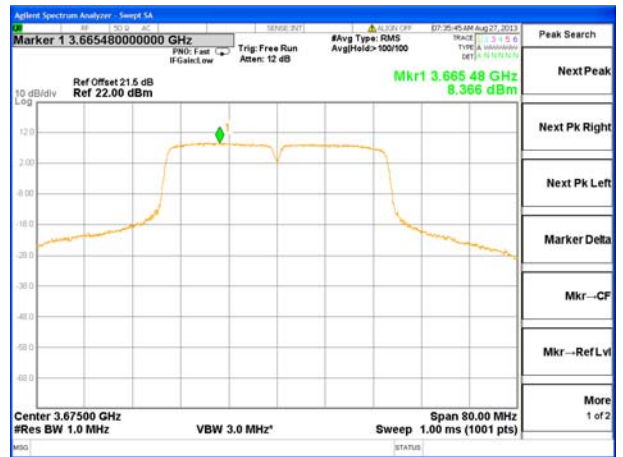

Plot # 71.

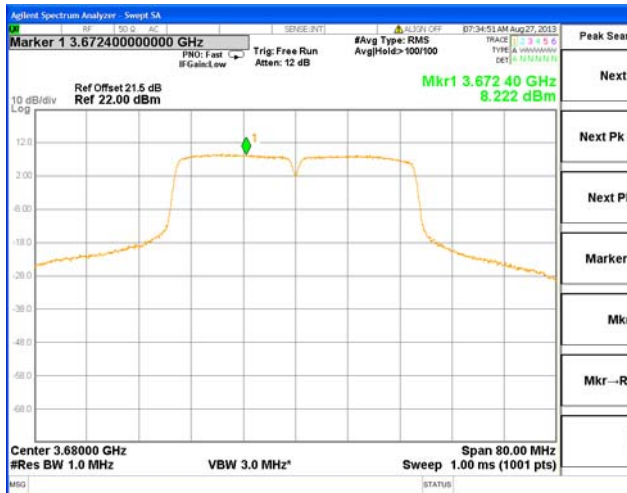

Plot # 72.



Test report No: 9312329195

Page 30 of 70 Pages

Title: 3.6 GHz Transceiver.

Model: Radio module AP0136450 FCC ID: Q3KRW3XMOD/ IC: 5100A-RW3XMOD

Chain 2

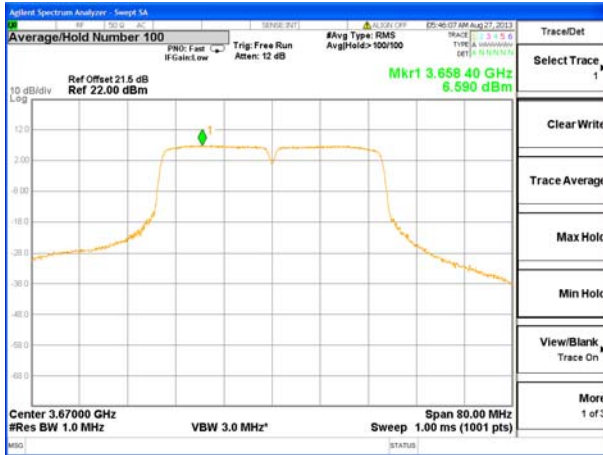

Plot # 73.

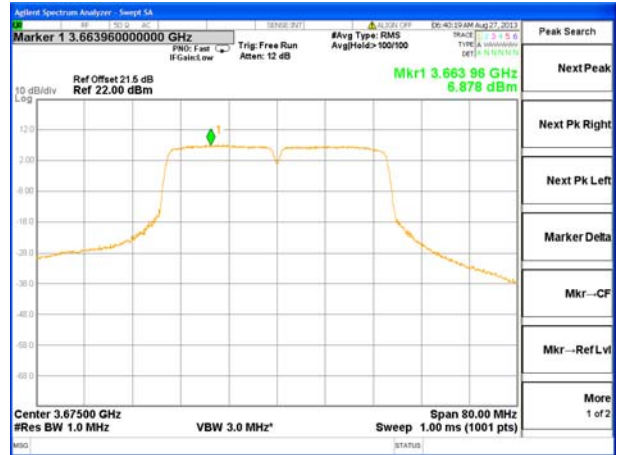

Plot # 74.

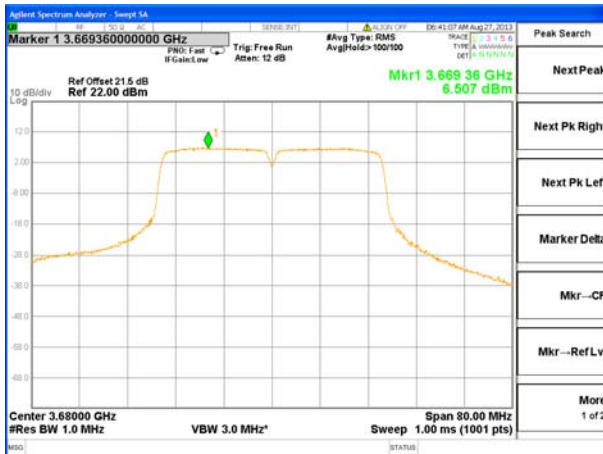

Plot # 75.



Test report No: 9312329195

Page 31 of 70 Pages

Title: 3.6 GHz Transceiver.

Model: Radio module AP0136450 **FCC ID:** Q3KRW3XMOD/ **IC:** 5100A-RW3XMOD

5.1.4. Spurious and band edge emission conducted § 90.1323, RSS -197 section 5.7

Method of measurement § 2.1051, 662911 D01 [E 3)(a)(iii)]
 Operating Frequency Range 3652.5 – 3697.5 MHz
 Detector used Average (RMS)
 Resolution bandwidth 1 MHz or >1% of EBW.
 Video bandwidth > RBW
 Output power setting Maximum allowed power.
 Ambient Temperature 24° C Relative Humidity 47% Air Pressure 1007 hPa

EBW, MHz	Carrier frequency, MHz	Modulation type	*Measured level, dBm	RBW, kHz	Integration BW, kHz	Specified limit, dBm	Result	Reference to plot #
5.0	3652.5	BPSK	-13.4	51.0	1000	-13.0	PASS	78
		64QAM	-13.7	51.0	1000	-13.0		79
	3675	64QAM	-36.9	1000	-	-13.0	PASS	83
		3697.5	BPSK	-14.0	51.0	1000	-13.0	PASS
64QAM	-13.8		51.0	1000	-13.0	90		
10.0	3655	64QAM	-15.7	100.0	1000	-13.0	PASS	96
	3675	64QAM	< -35.0	1000	-	-13.0		100
	3695	64QAM	-15.4	100.0	1000	-13.0		106
20.0	3660	64QAM	-13.6	200.0	1000	-13.0	PASS	112
	3675	64QAM	< -35.0	1000	-	-13.0		116
	3690	64QAM	-13.9	200.0	1000	-13.0		122
40.0	3670	64QAM	-13.2	1000	-	-13.0	PASS	127
	3680	64QAM	-14.1	1000	-	-13.0		132

*Emission level adjusted by $10\log(2) = 3$ dB.

LIMIT

For operation in the 3650 – 3700 MHz band, the power of any emissions outside the licensee’s frequency band(s) of operation shall be attenuated below the transmitter power (P) within the licensed band(s) of operation, measured in watts, by at least $43+10\log(P)$ dB = -13 dBm.



Test report No: 9312329195

Page 32 of 70 Pages

Title: 3.6 GHz Transceiver.

Model: Radio module AP0136450 FCC ID: Q3KRW3XMOD/ IC: 5100A-RW3XMOD

Spurious emissions test at antenna terminal.

5 MHz EBW option. 3652.5 MHz carrier frequency.

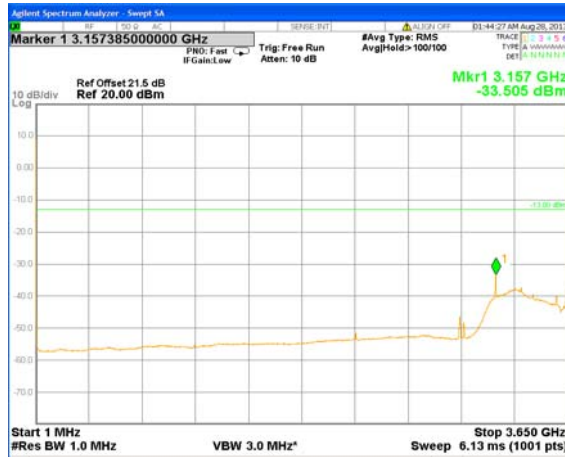

Plot # 76.

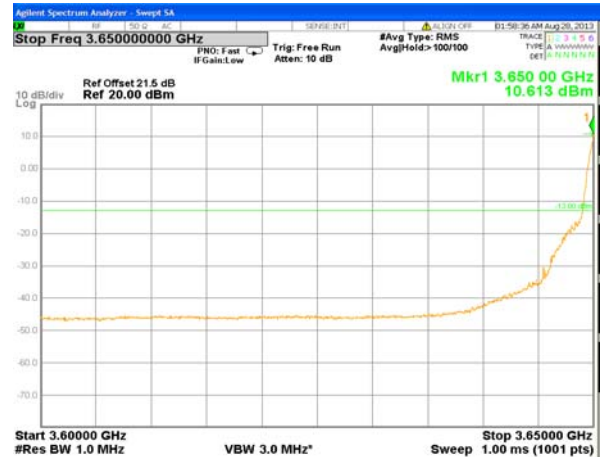

Plot # 77.

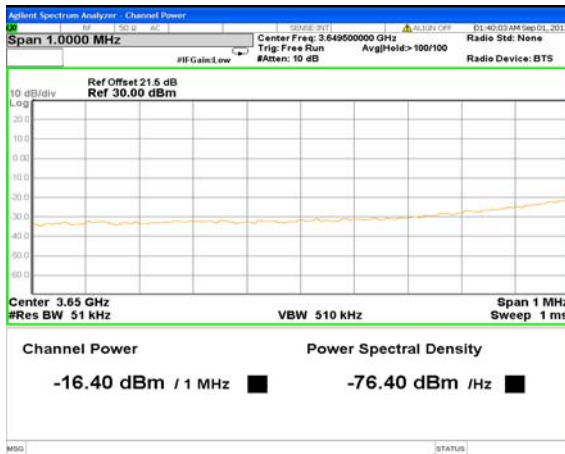

Plot # 78. Modulation BPSK. Output 20.8 dBm

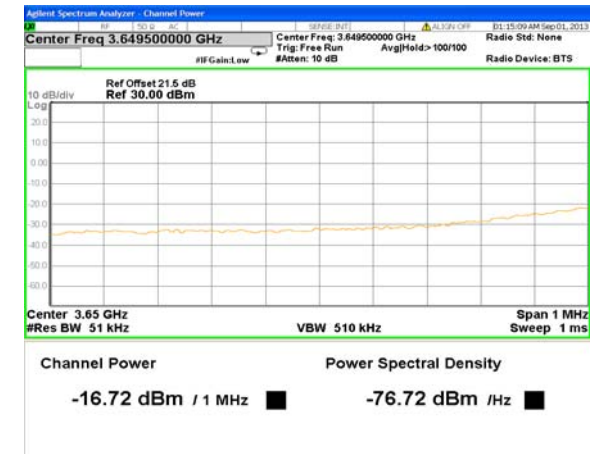

Plot # 79. Modulation 64QAM. Output 20.8 dBm

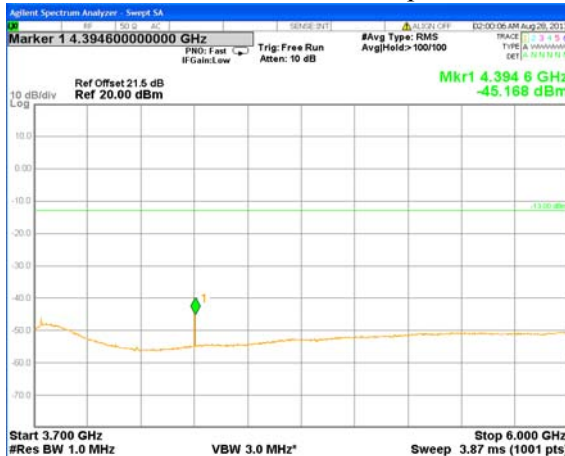

Plot # 80.

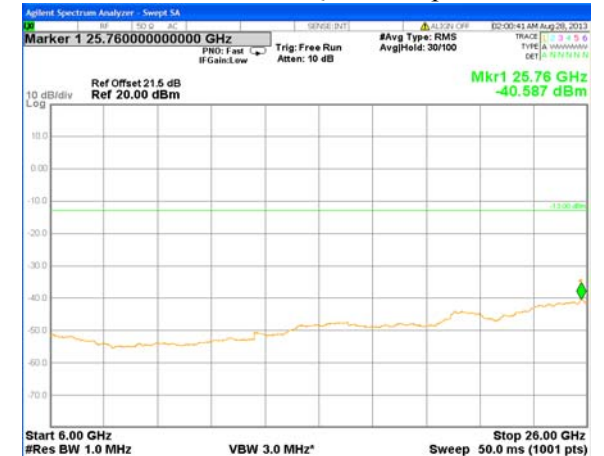

Plot # 81.



Test report No: 9312329195

Page 33 of 70 Pages

Title: 3.6 GHz Transceiver.

Model: Radio module AP0136450 FCC ID: Q3KRW3XMOD/ IC: 5100A-RW3XMOD

5 MHz EBW. 3675 MHz carrier frequency.

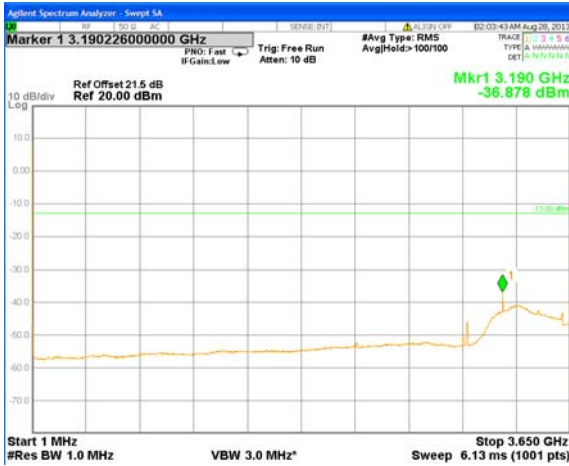

Plot # 82.

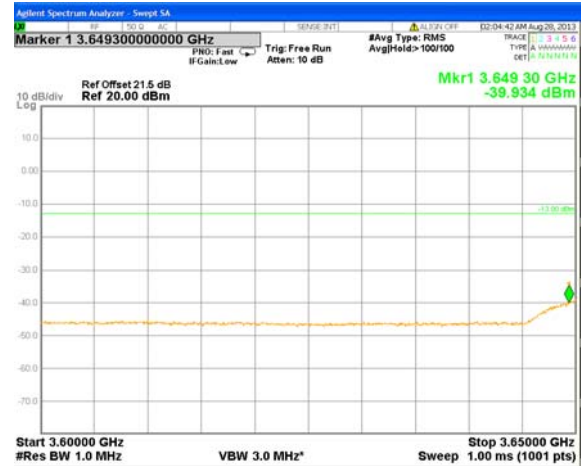

Plot # 83.

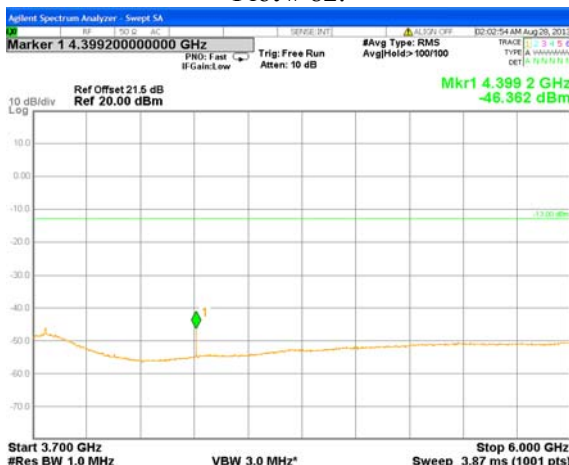

Plot # 84.

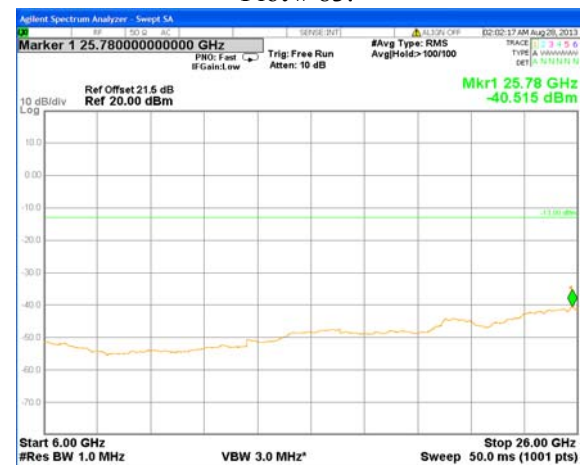

Plot # 85.

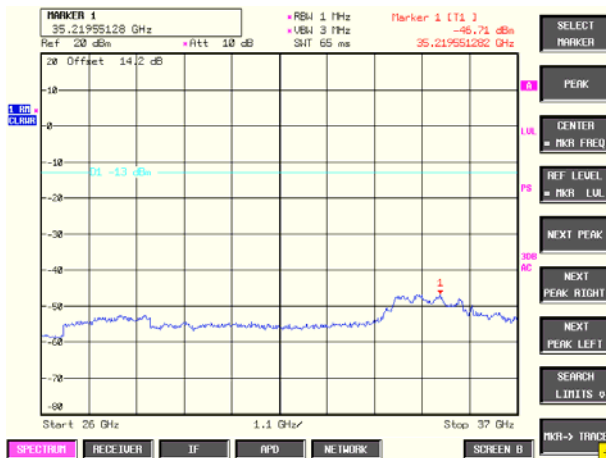

Plot # 86.



Test report No: 9312329195

Page 34 of 70 Pages

Title: 3.6 GHz Transceiver.

Model: Radio module AP0136450 FCC ID: Q3KRW3XMOD/ IC: 5100A-RW3XMOD

5 MHz EBW. 3697.5 MHz carrier frequency.



Plot # 87.

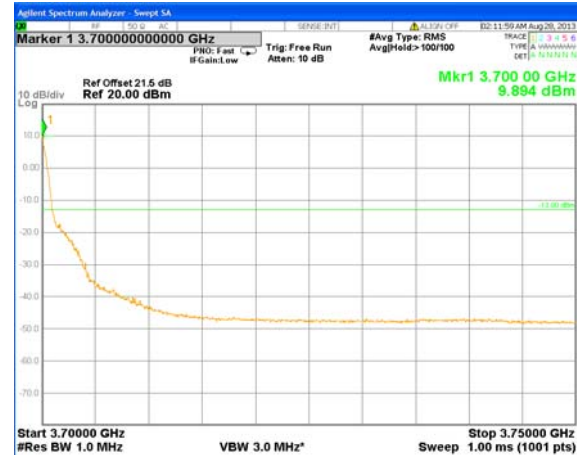

Plot # 88.

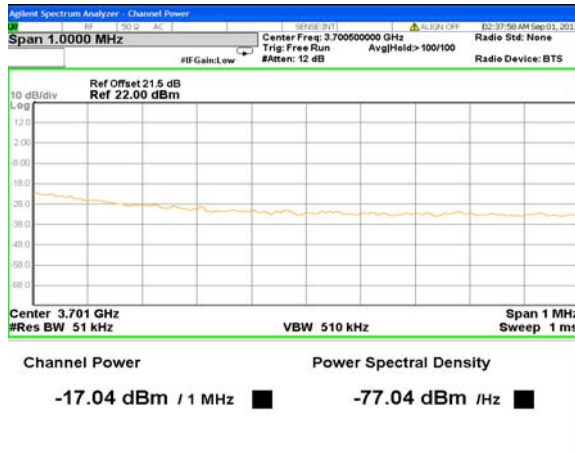

Plot # 89. Modulation BPSK. Out. PW 20.6 dBm.

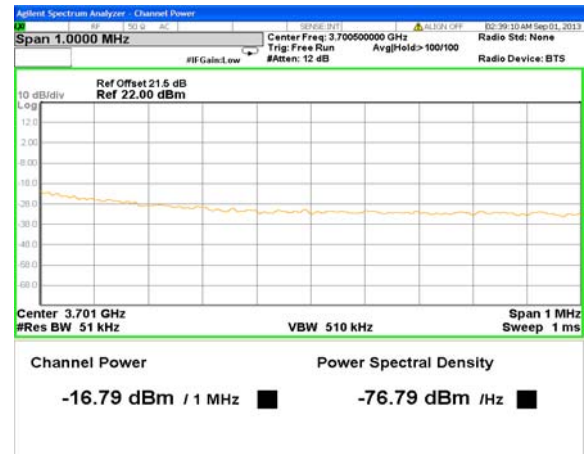

Plot # 90. Modulation 64QAM. Out. PW 20.6 dBm.



Test report No: 9312329195

Page 35 of 70 Pages

Title: 3.6 GHz Transceiver.

Model: Radio module AP0136450 FCC ID: Q3KRW3XMOD/ IC: 5100A-RW3XMOD

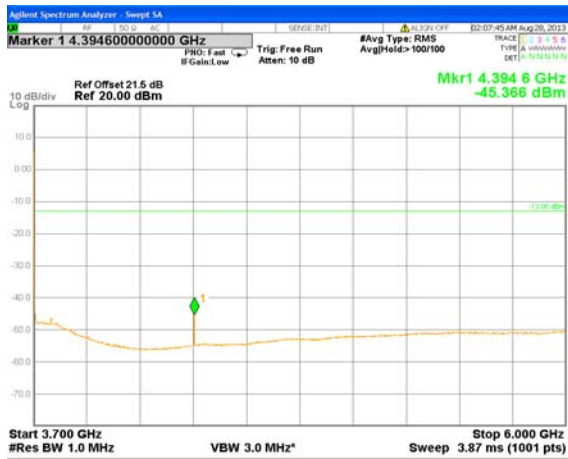

Plot # 91.



Plot # 92.

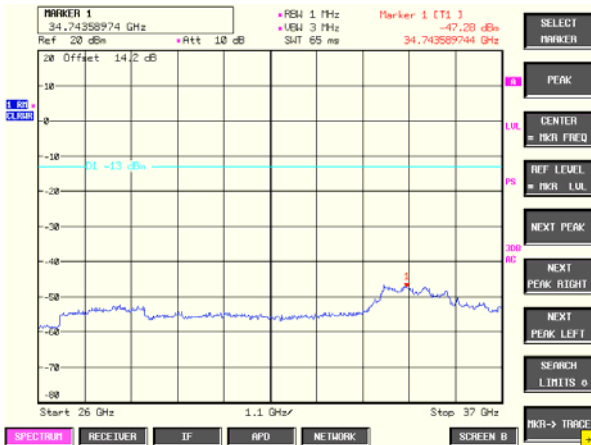

Plot # 93.



Test report No: 9312329195

Page 36 of 70 Pages

Title: 3.6 GHz Transceiver.

Model: Radio module AP0136450 FCC ID: Q3KRW3XMOD/ IC: 5100A-RW3XMOD

10 MHz EBW. 3655 MHz carrier frequency.

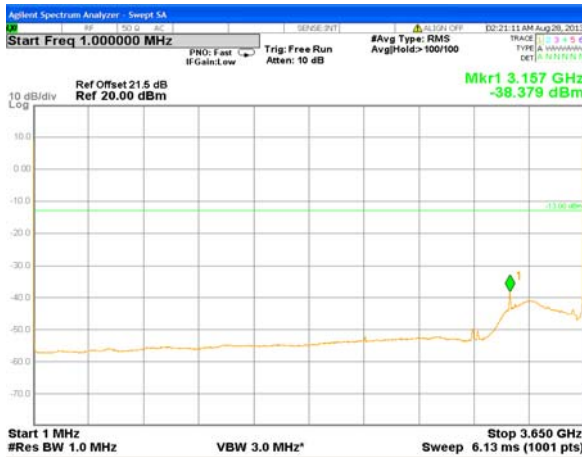

Plot # 94.

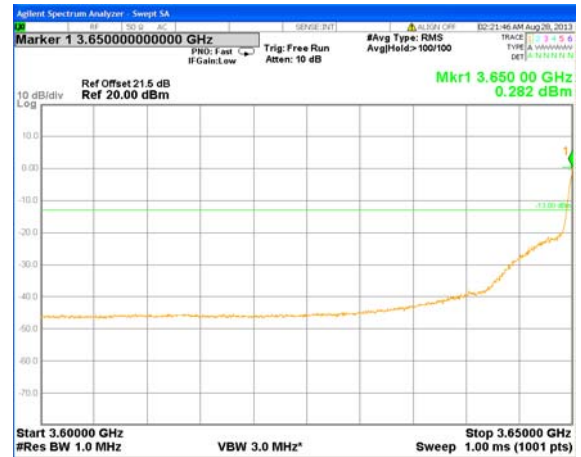

Plot # 95.

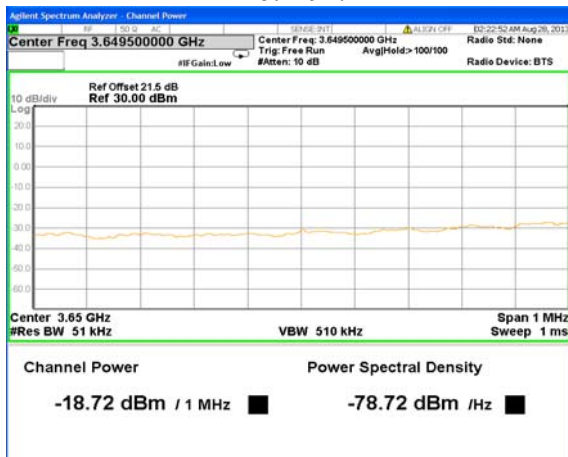

Plot # 96. Out. PW 21.4 dBm.

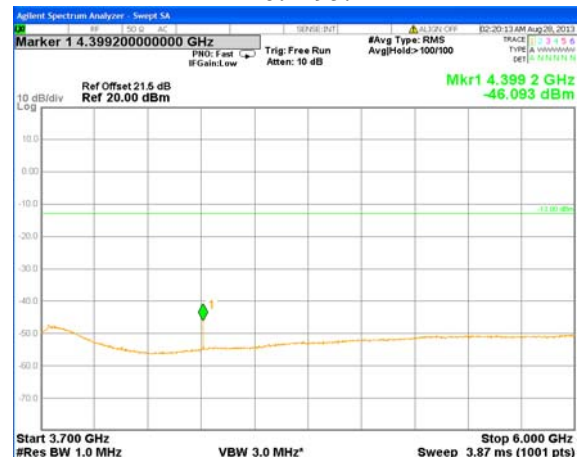

Plot # 97.



Plot # 98.

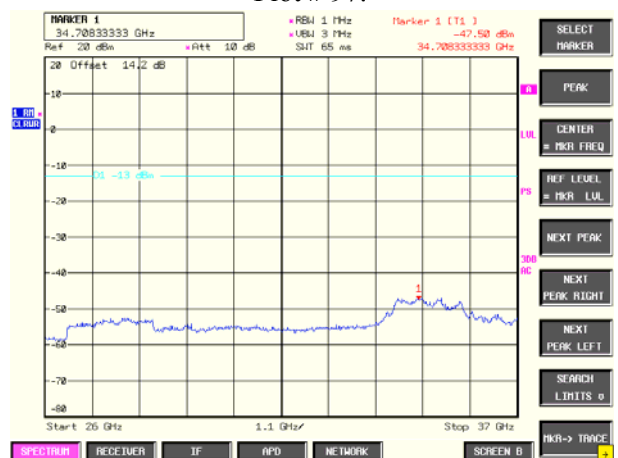

Plot # 99.



Test report No: 9312329195

Page 37 of 70 Pages

Title: 3.6 GHz Transceiver.

Model: Radio module AP0136450 FCC ID: Q3KRW3XMOD/ IC: 5100A-RW3XMOD

10 MHz EBW. 3675 MHz carrier frequency.

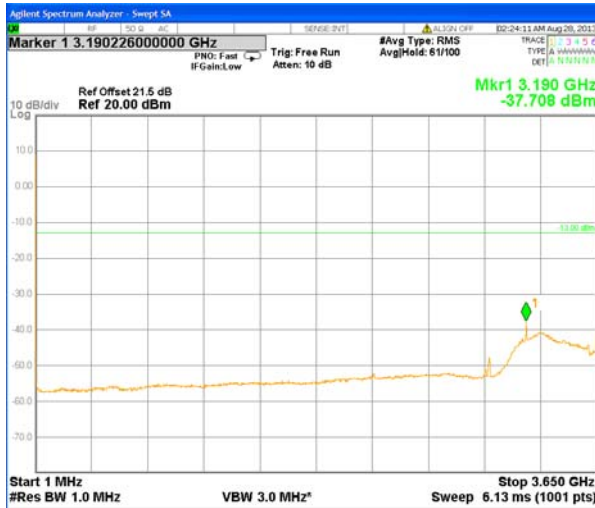

Plot # 100.

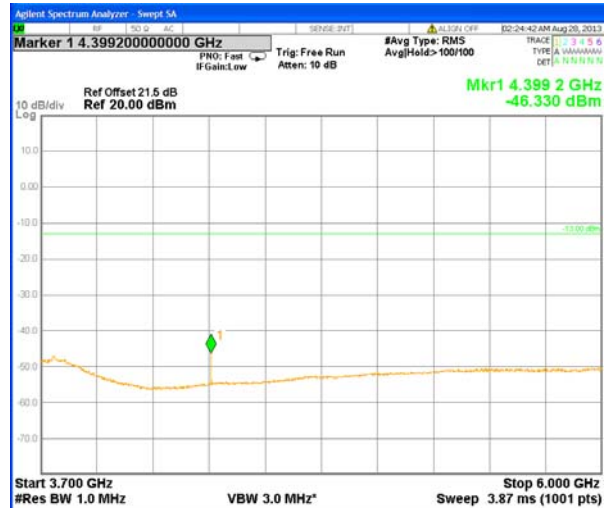

Plot # 101.

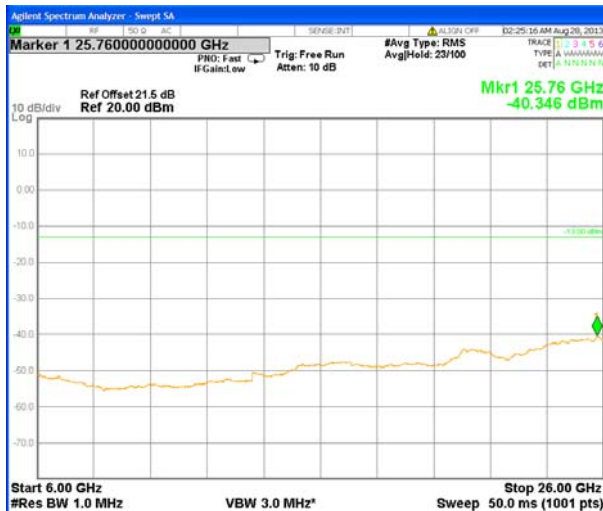

Plot # 102.

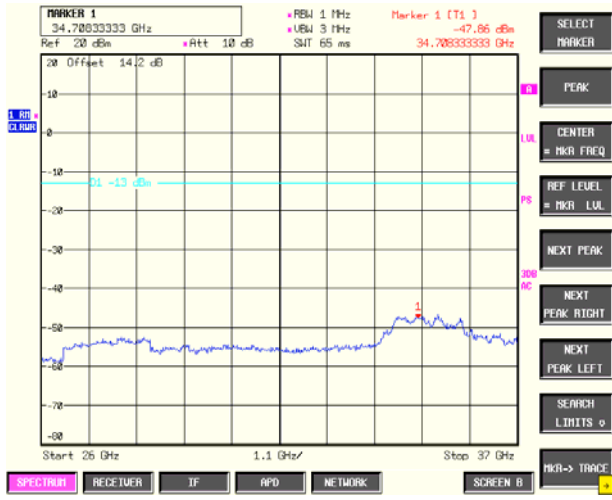

Plot # 103.



Test report No: 9312329195

Page 38 of 70 Pages

Title: 3.6 GHz Transceiver.

Model: Radio module AP0136450 FCC ID: Q3KRW3XMOD/ IC: 5100A-RW3XMOD

10 MHz EBW. 3695 MHz carrier frequency.



Plot # 104.



Plot # 105.

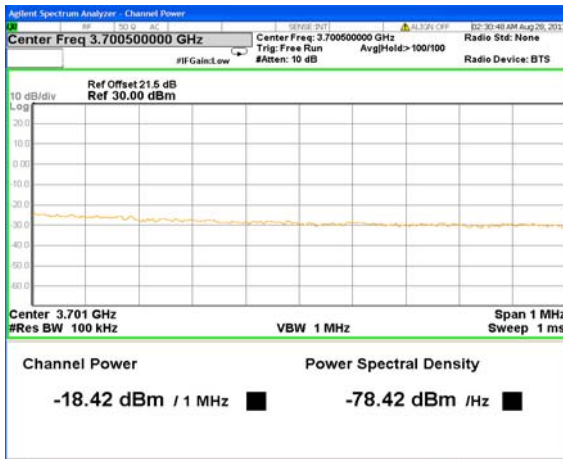

Plot # 106. Out. PW 21.4 dBm.

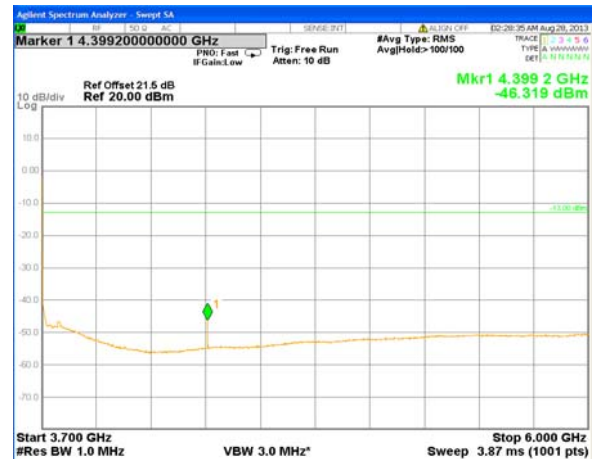

Plot # 107.

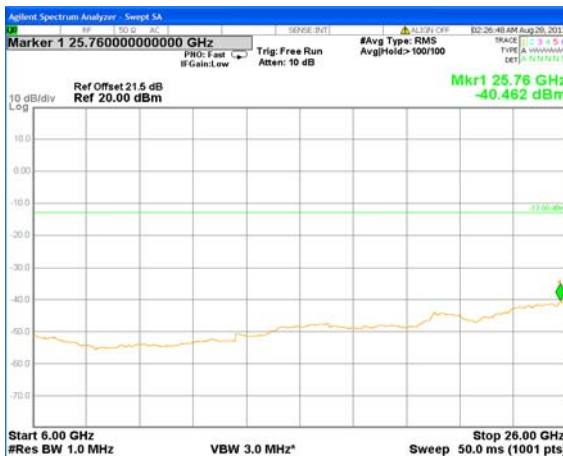

Plot # 108.

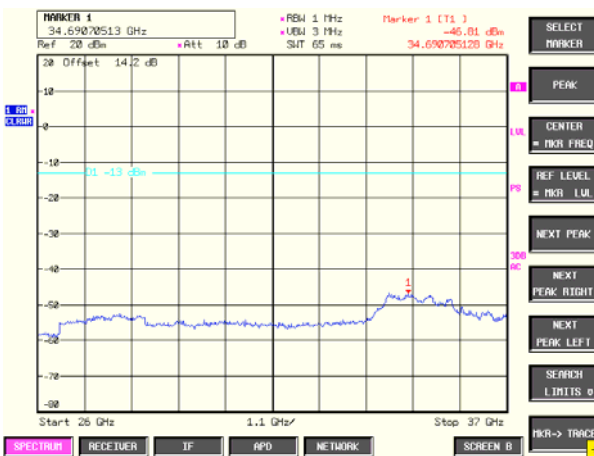

Plot # 109.



Test report No: 9312329195

Page 39 of 70 Pages

Title: 3.6 GHz Transceiver.

Model: Radio module AP0136450 FCC ID: Q3KRW3XMOD/ IC: 5100A-RW3XMOD

20 MHz EBW. 3660 MHz carrier frequency.

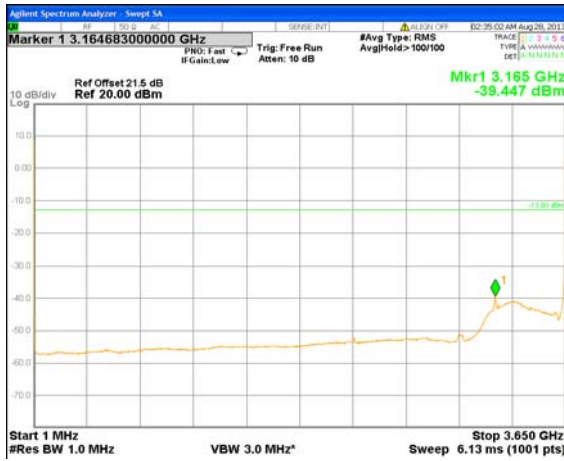

Plot # 110.



Plot # 111.

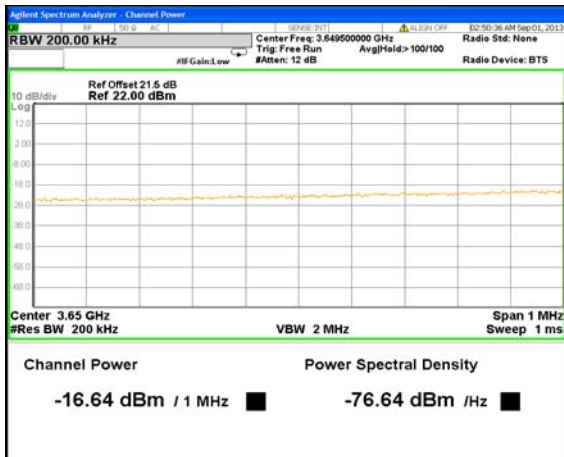

Plot # 112. Out. PW 22.6 dBm.

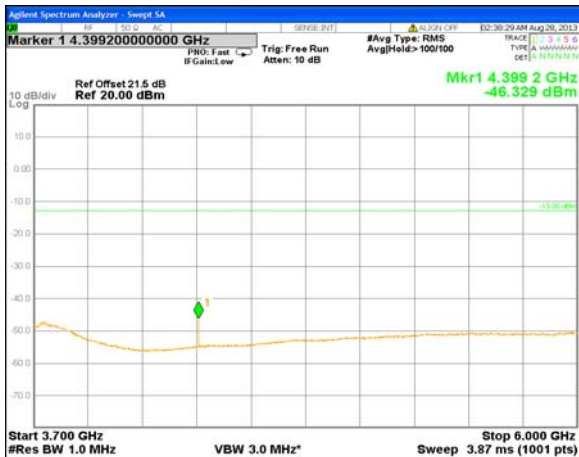

Plot # 113.

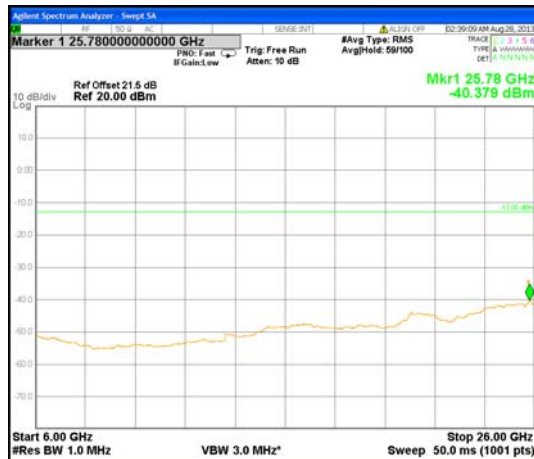

Plot # 114.

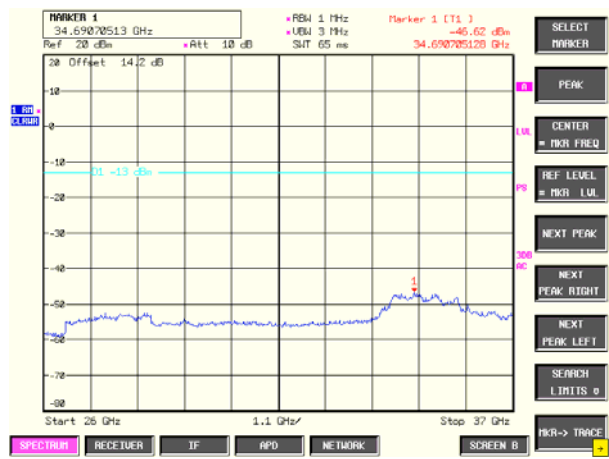

Plot # 115.



Test report No: 9312329195

Page 40 of 70 Pages

Title: 3.6 GHz Transceiver.

Model: Radio module AP0136450 FCC ID: Q3KRW3XMOD/ IC: 5100A-RW3XMOD

20 MHz EBW. 3675 MHz carrier frequency.

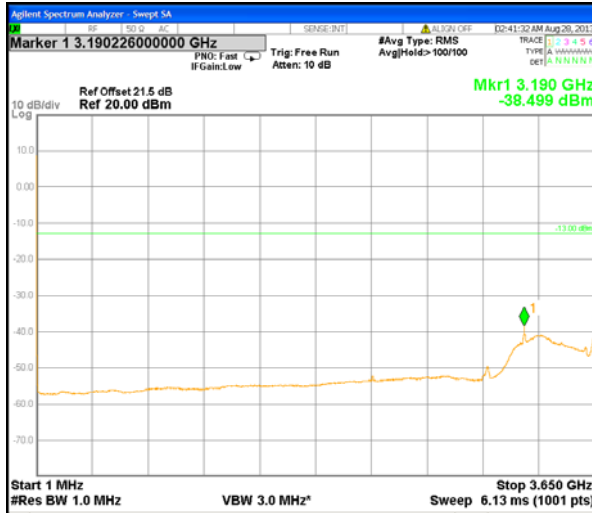

Plot # 116.

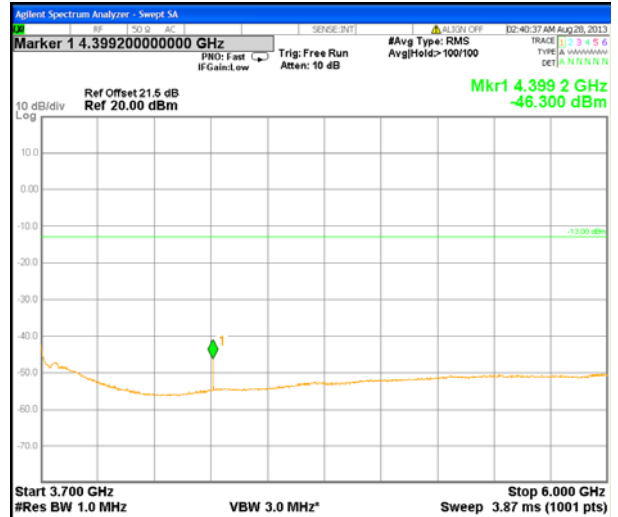

Plot # 117.

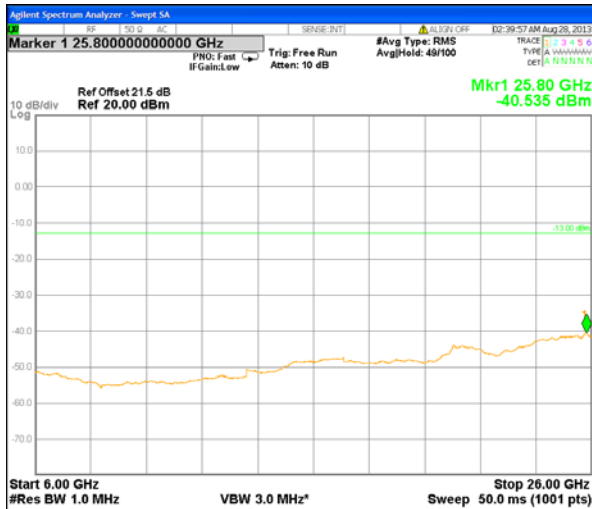

Plot # 118.

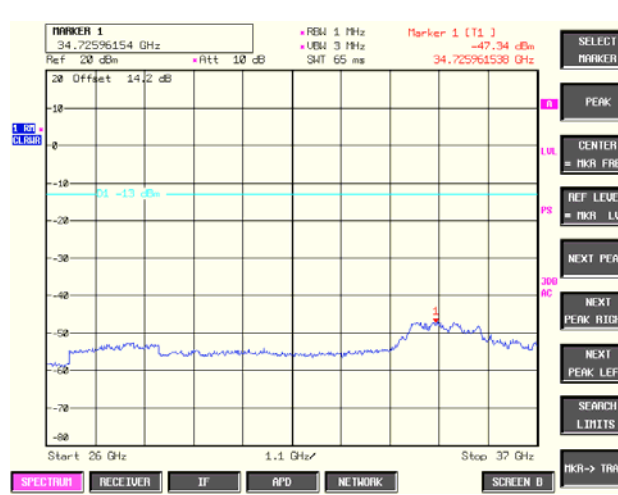

Plot # 119.



Test report No: 9312329195

Page 41 of 70 Pages

Title: 3.6 GHz Transceiver.

Model: Radio module AP0136450 FCC ID: Q3KRW3XMOD/ IC: 5100A-RW3XMOD

20 MHz EBW. 3690 MHz carrier frequency.

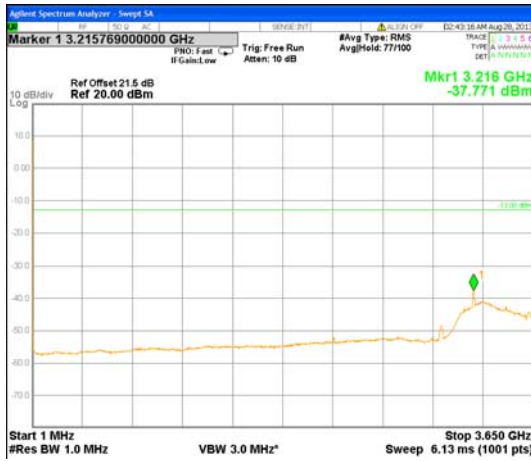

Plot # 120.



Plot # 121.

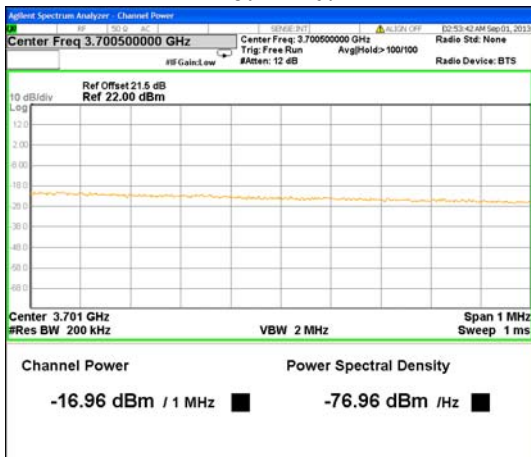

Plot # 122. Output PW 22.9 dBm.

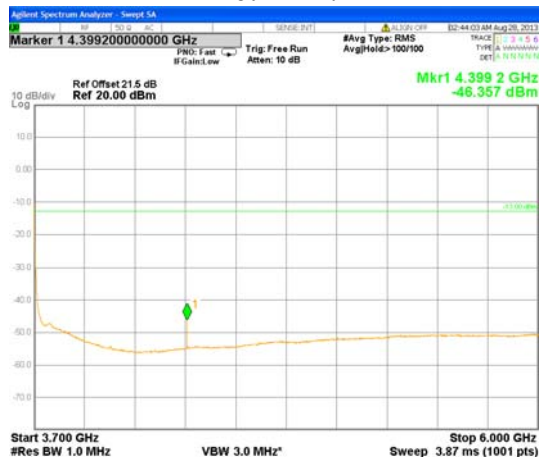

Plot # 123.



Plot # 124.

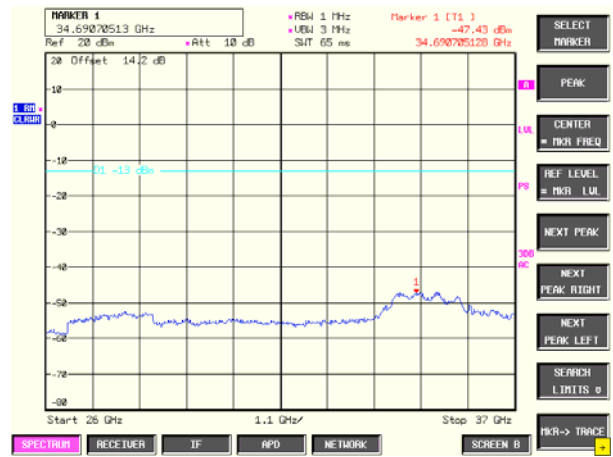

Plot # 125.



Test report No: 9312329195

Page 42 of 70 Pages

Title: 3.6 GHz Transceiver.

Model: Radio module AP0136450 FCC ID: Q3KRW3XMOD/ IC: 5100A-RW3XMOD

40 MHz EBW. 3670 MHz carrier frequency.

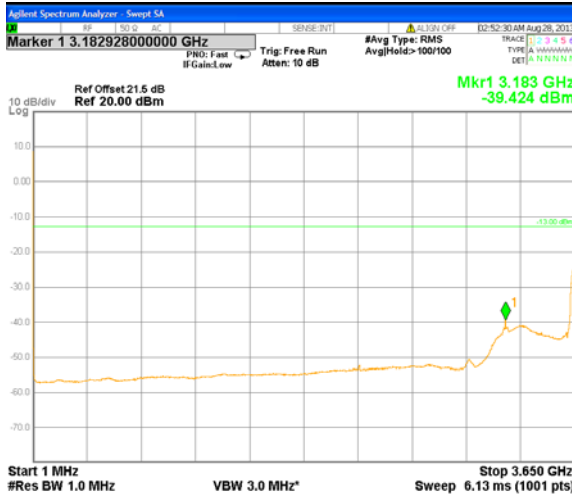

Plot # 126.

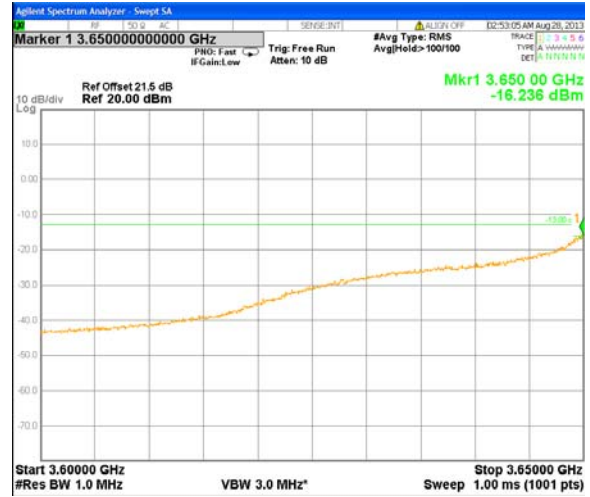

Plot # 127.

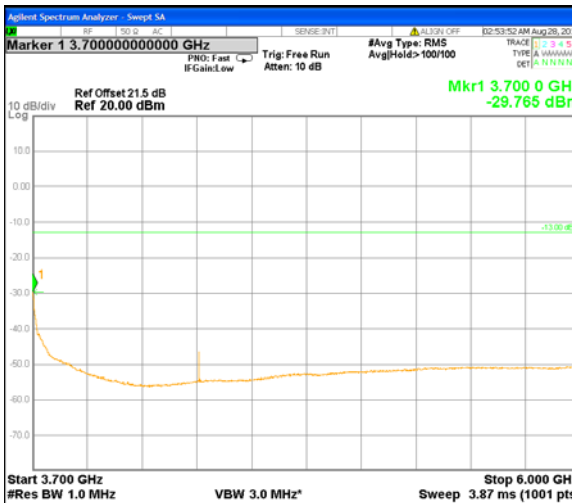

Plot # 128.

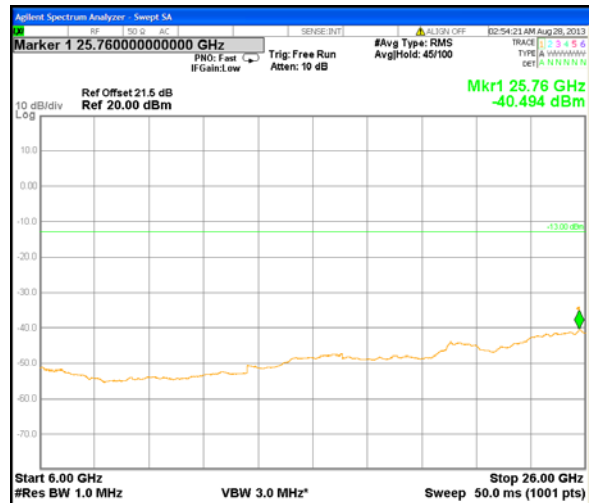

Plot # 129.

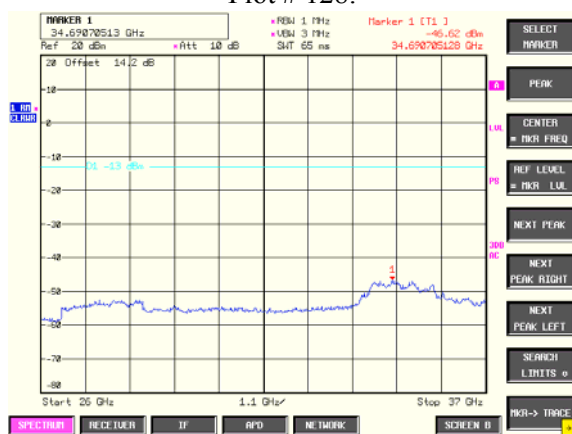

Plot # 130.



Test report No: 9312329195

Page 43 of 70 Pages

Title: 3.6 GHz Transceiver.

Model: Radio module AP0136450 FCC ID: Q3KRW3XMOD/ IC: 5100A-RW3XMOD

40 MHz EBW. 3680 MHz carrier frequency.

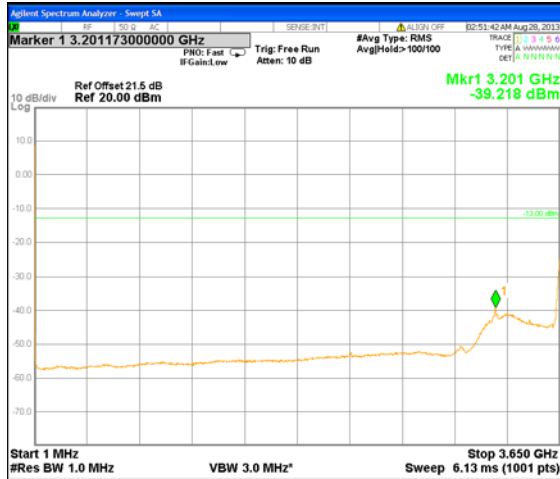

Plot # 131.

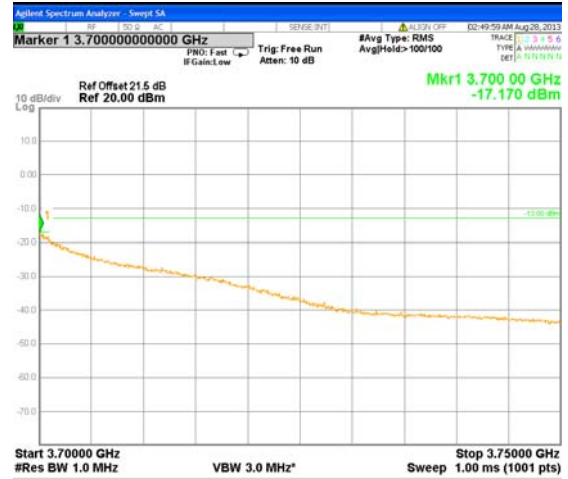

Plot # 132.

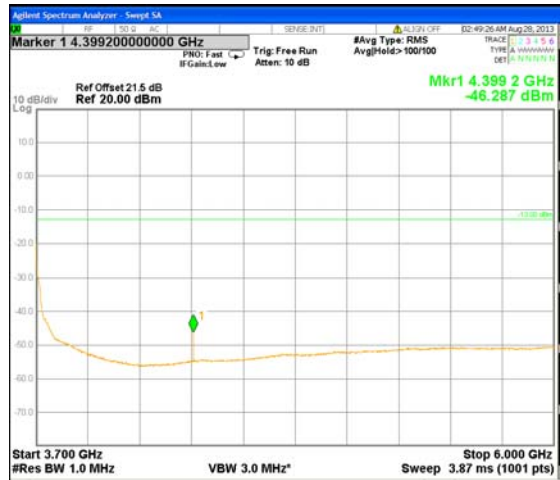

Plot # 133.

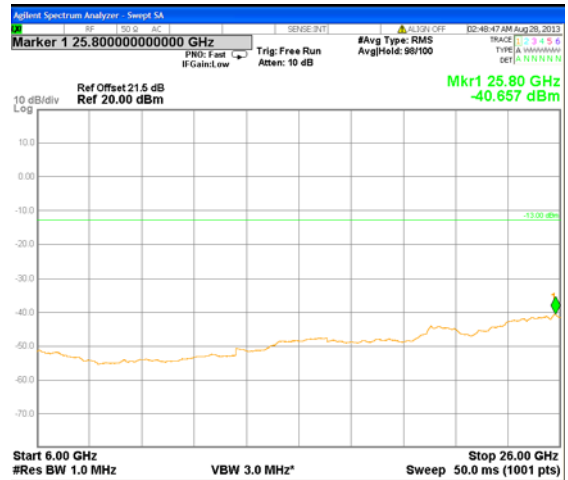

Plot # 134.

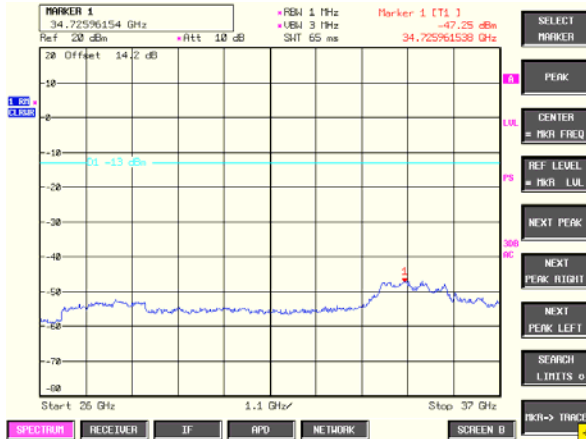

Plot # 135.

**Test report No: 9312329195****Page 44 of 70 Pages****Title: 3.6 GHz Transceiver.****Model: Radio module AP0136450 FCC ID: Q3KRW3XMOD/ IC: 5100A-RW3XMOD**

5.1.5. Radiated emissions test according to §§ 90.1323, 2.1053, RSS-197.

Method of measurement	§ 2.1053, ANSI/TIA-603-C-2004 section 2.2.12		
Operating Frequency Range	3652.5 – 3697.5 MHz		
Detector used	Average (RMS)		
Resolution bandwidth	1 MHz.		
Video bandwidth	> RBW		
Output power setting	Maximum allowed power.		
Ambient Temperature	24 ⁰ C	Relative Humidity	47% Air Pressure 1007 hPa

The frequency spectrum was investigated from the lowest radio frequency signal generated in the equipment up to the tenth harmonic of the highest fundamental frequency. For the test results refer to the plots in this section.

LIMIT

For operation in the 3650 – 3700 MHz band, the power of any emissions outside the licensee's frequency band(s) of operation shall be attenuated below the transmitter power (P) within the licensed band(s) of operation, measured in watts, by at least $43+10\text{Log}(P)$ dB = -13 dBm (correspondent to 82.2 dB μ V/m field strength at 3m distance).

TEST PROCEDURE

Substitution method.

The measurements were performed according to ANSI/TIA-603-C-2004 section 2.2.12 test method. Investigation of transmitter spurious emissions was performed. EUT was replaced by generator and substitution antenna. Level calculated from generator output level, substitution antenna gain and connected cable loss was compared with the limit. Transmitter was operated at lowest, middle and highest carrier frequencies in 3650 – 3700 MHz frequency range.



Test report No: 9312329195

Page 45 of 70 Pages

Title: 3.6 GHz Transceiver.

Model: Radio module AP0136450 FCC ID: Q3KRW3XMOD/ IC: 5100A-RW3XMOD

Recorded and shown below results are common and worst case for all emission bandwidths and transmitter frequencies.

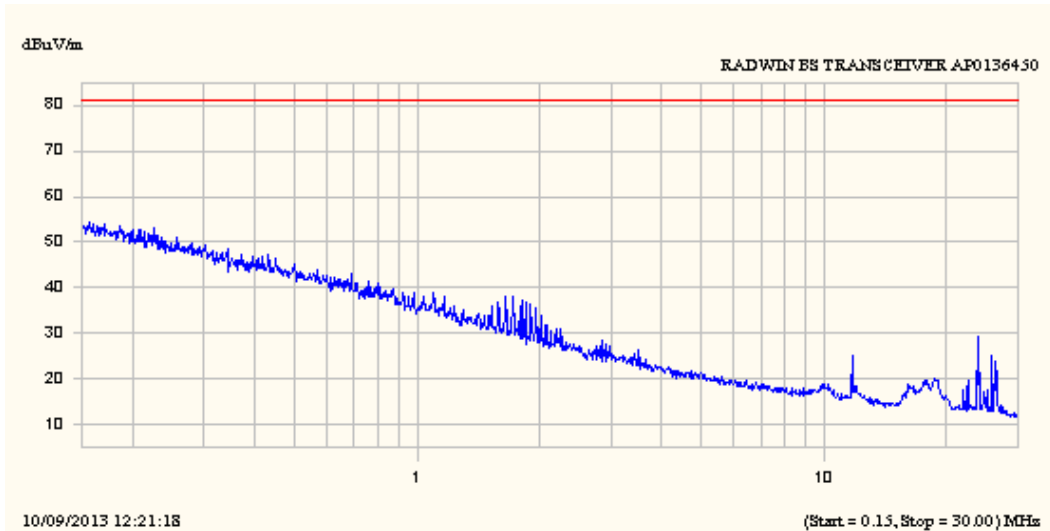

Plot # 136.

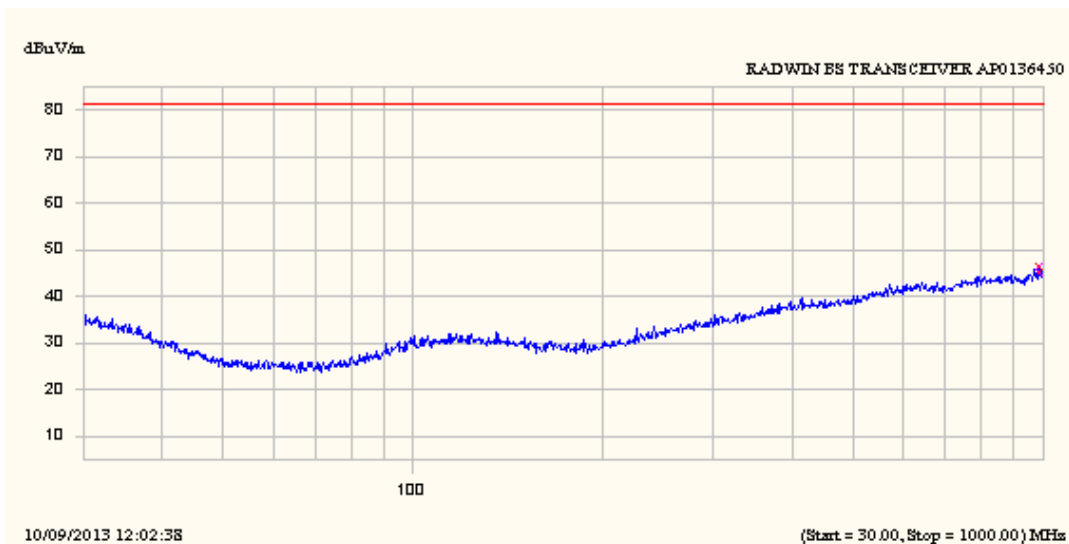

Plot # 137.



Test report No: 9312329195

Page 46 of 70 Pages

Title: 3.6 GHz Transceiver.

Model: Radio module AP0136450 FCC ID: Q3KRW3XMOD/ IC: 5100A-RW3XMOD

5 MHz EBW option. 3652.5 MHz carrier frequency.

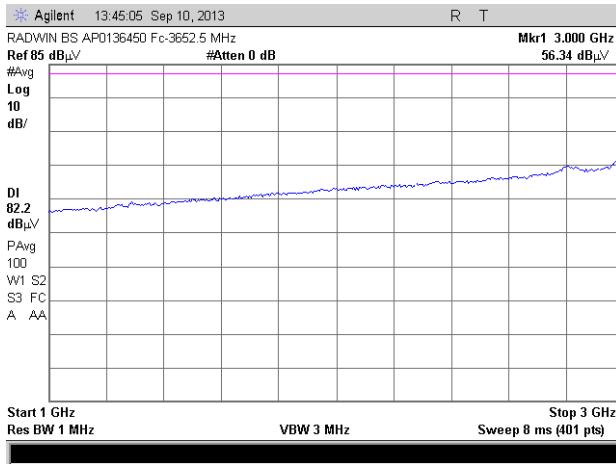

Plot # 138.

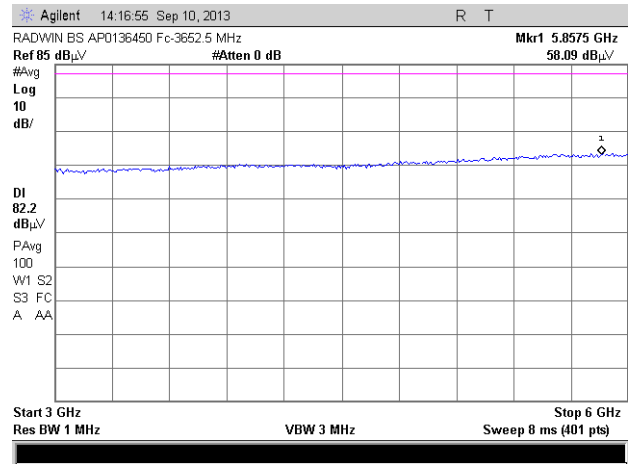

Plot # 139.

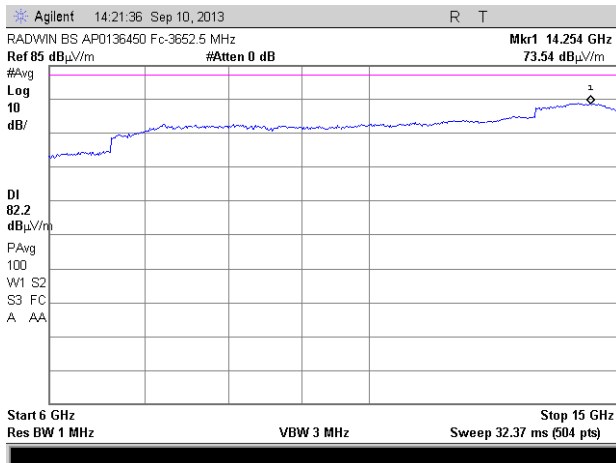

Plot # 140.

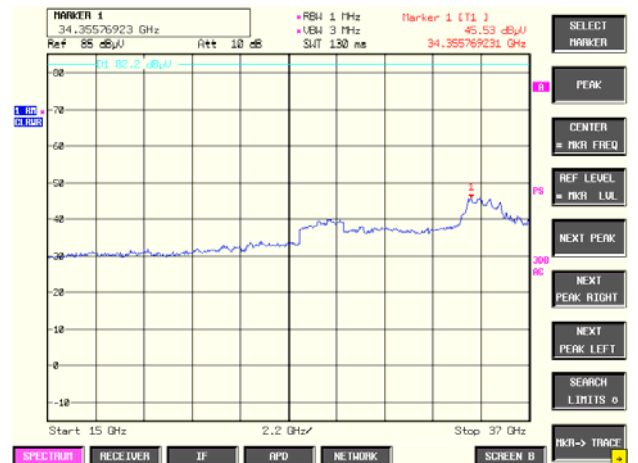

Plot # 141.



Test report No: 9312329195

Page 47 of 70 Pages

Title: 3.6 GHz Transceiver.

Model: Radio module AP0136450 FCC ID: Q3KRW3XMOD/ IC: 5100A-RW3XMOD

5 MHz EBW option. 3675 MHz carrier frequency.

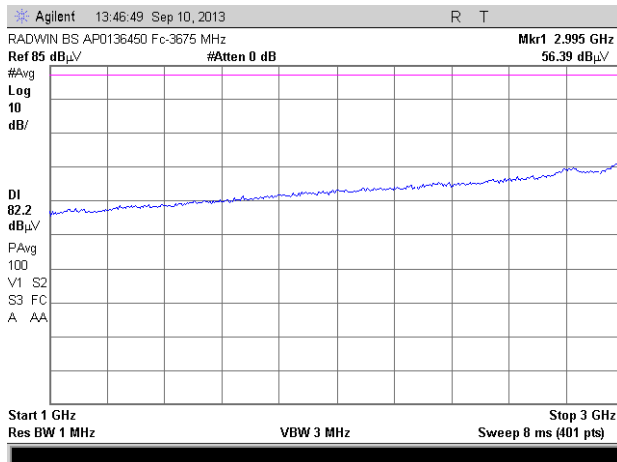

Plot # 142.

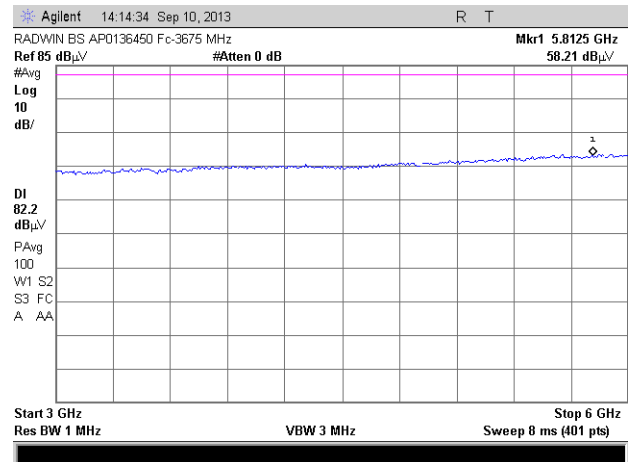

Plot # 143.

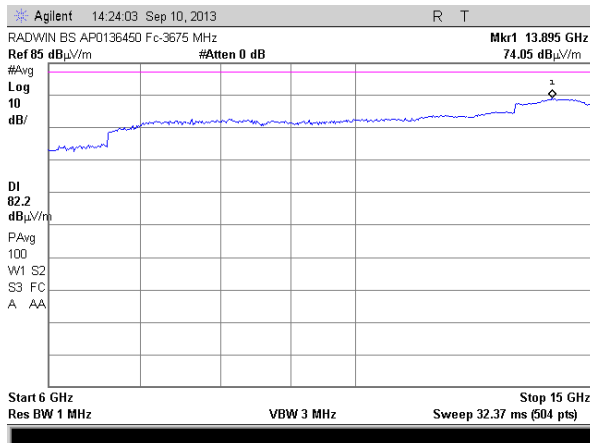

Plot # 144.

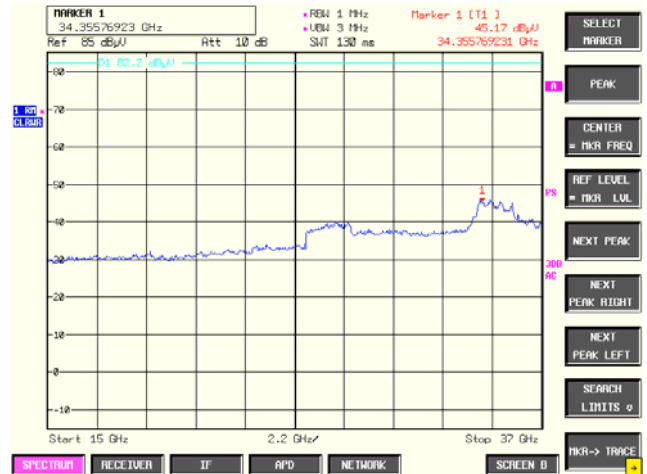

Plot # 145.



Test report No: 9312329195

Page 48 of 70 Pages

Title: 3.6 GHz Transceiver.

Model: Radio module AP0136450 FCC ID: Q3KRW3XMOD/ IC: 5100A-RW3XMOD

3697.5 MHz carrier frequency.

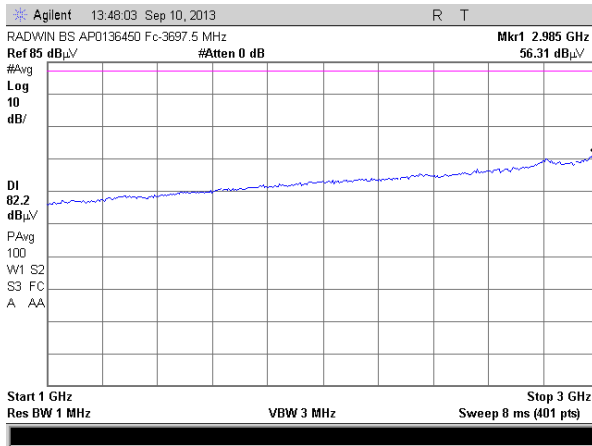

Plot # 146.

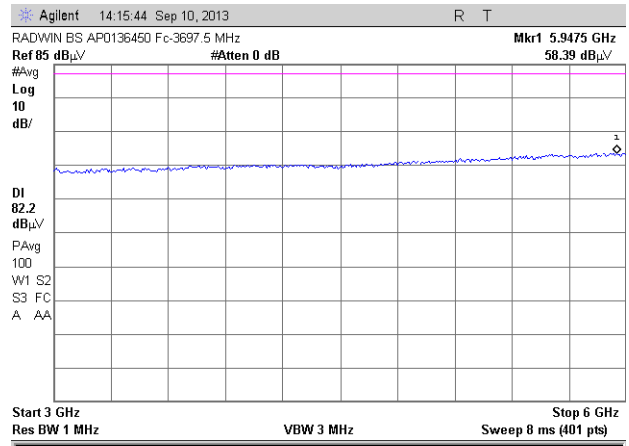

Plot # 147.

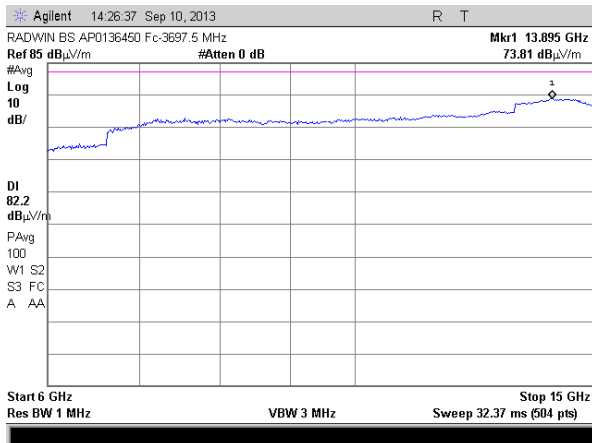

Plot # 148.

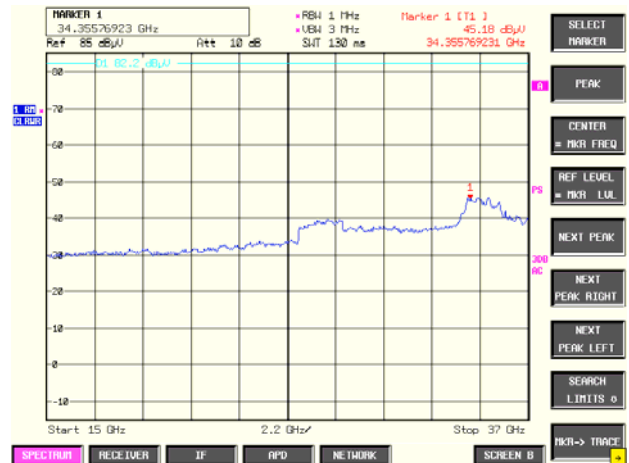

Plot # 149.



Test report No: 9312329195

Page 49 of 70 Pages

Title: 3.6 GHz Transceiver.

Model: Radio module AP0136450 FCC ID: Q3KRW3XMOD/ IC: 5100A-RW3XMOD

10 MHz EBW option. 3655 MHz carrier frequency.

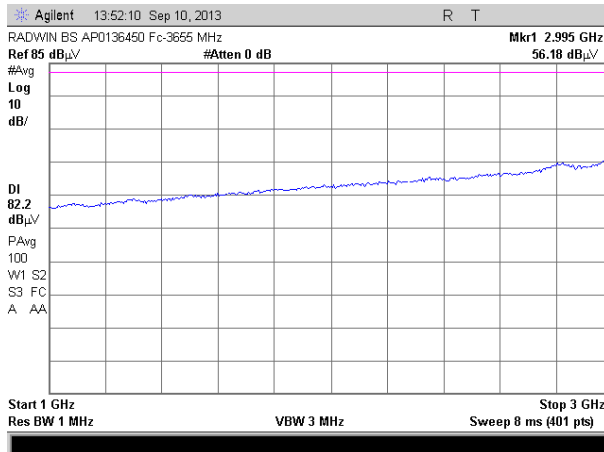

Plot # 150.

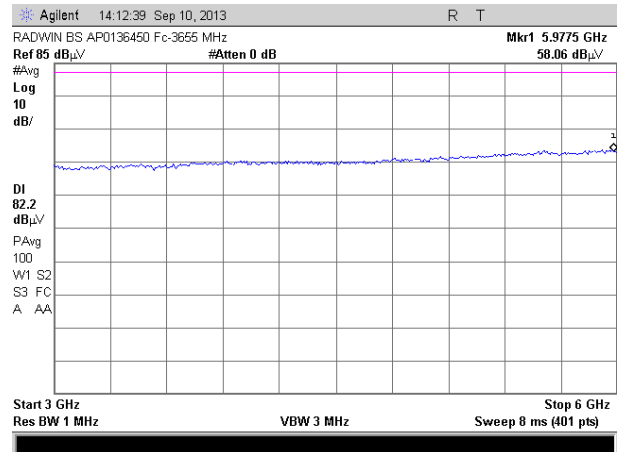

Plot # 151.

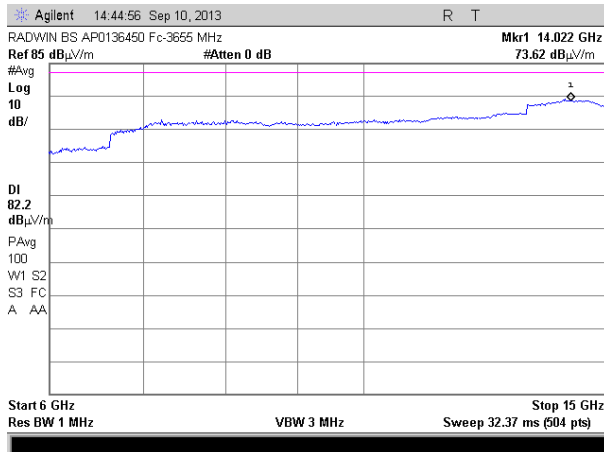

Plot # 152.

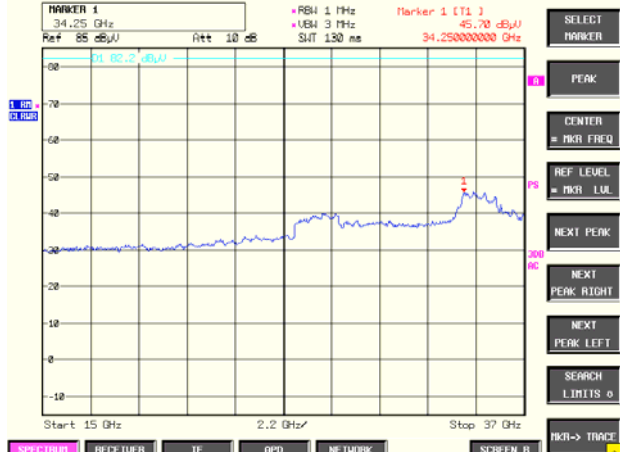

Plot # 153.



Test report No: 9312329195

Page 50 of 70 Pages

Title: 3.6 GHz Transceiver.

Model: Radio module AP0136450 FCC ID: Q3KRW3XMOD/ IC: 5100A-RW3XMOD

3675 MHz carrier frequency.

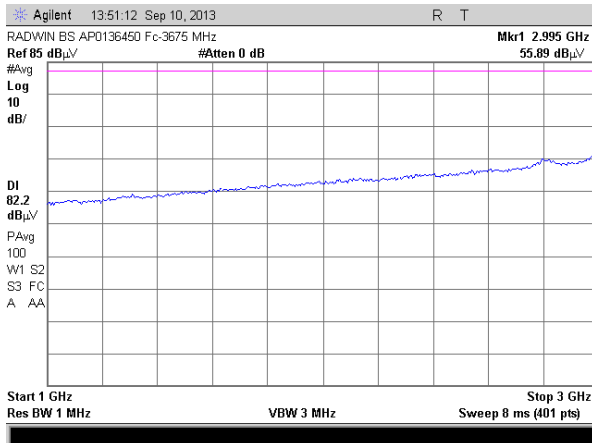

Plot # 154.

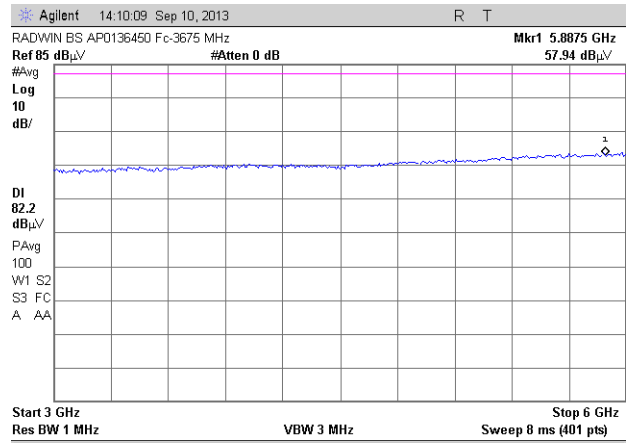

Plot # 155.

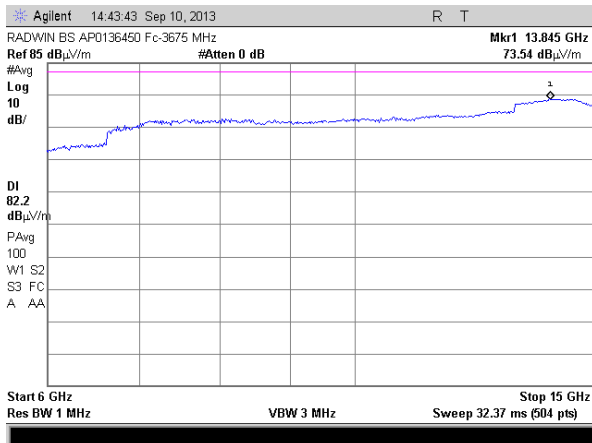

Plot # 156.

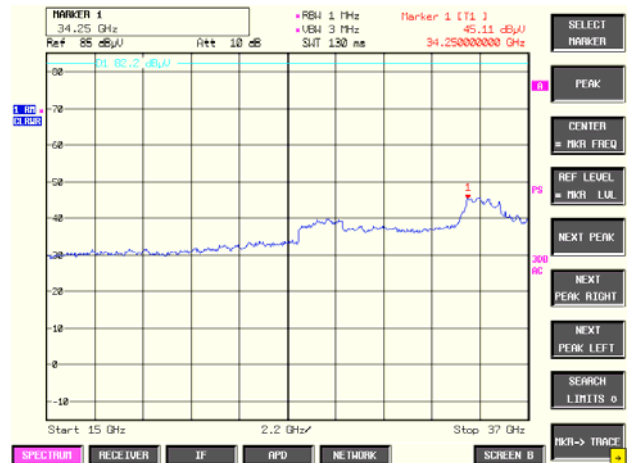

Plot # 157.



Test report No: 9312329195

Page 51 of 70 Pages

Title: 3.6 GHz Transceiver.

Model: Radio module AP0136450 FCC ID: Q3KRW3XMOD/ IC: 5100A-RW3XMOD

3695 MHz carrier frequency.

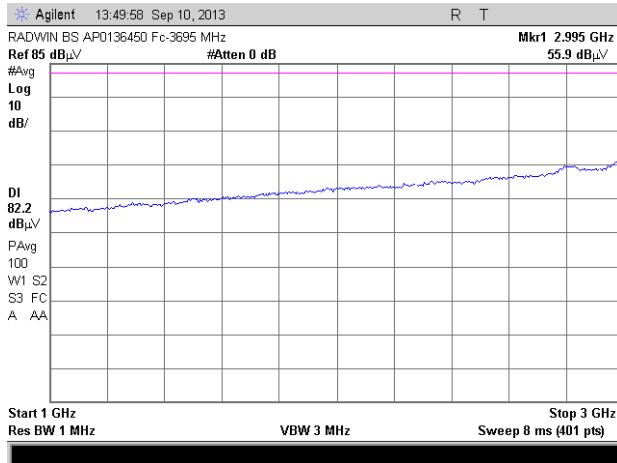

Plot # 158.

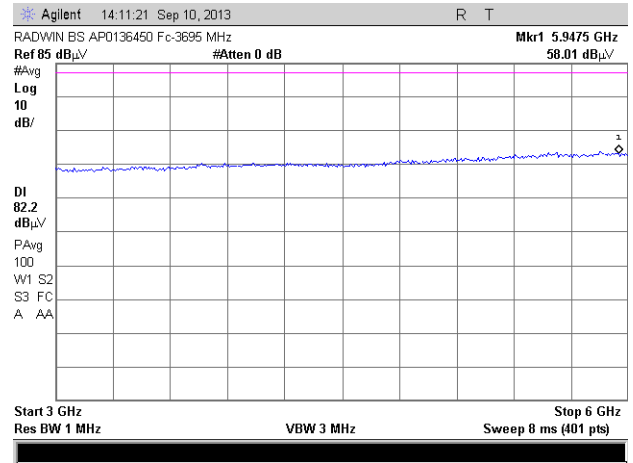

Plot # 159.

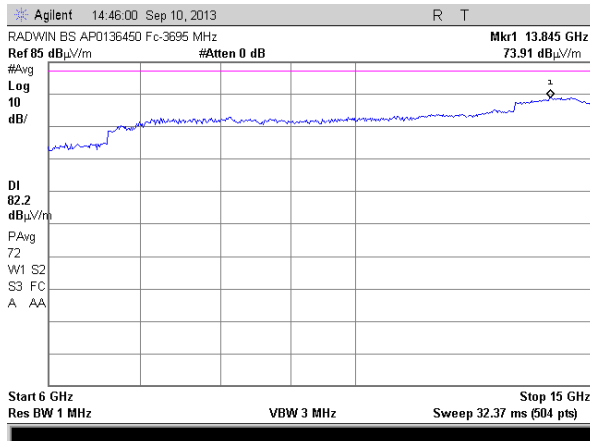

Plot # 160.

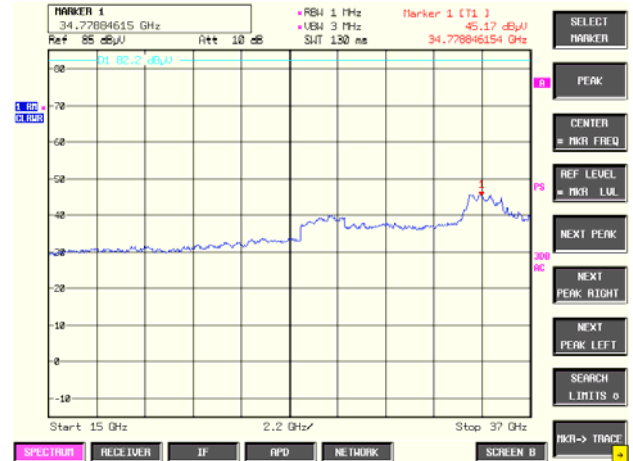

Plot # 161.



Test report No: 9312329195

Page 52 of 70 Pages

Title: 3.6 GHz Transceiver.

Model: Radio module AP0136450 FCC ID: Q3KRW3XMOD/ IC: 5100A-RW3XMOD

20 MHz EBW option. 3660 MHz carrier frequency.

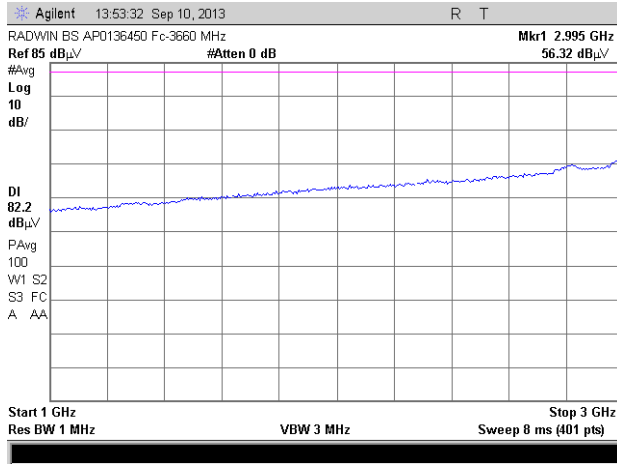

Plot # 162.

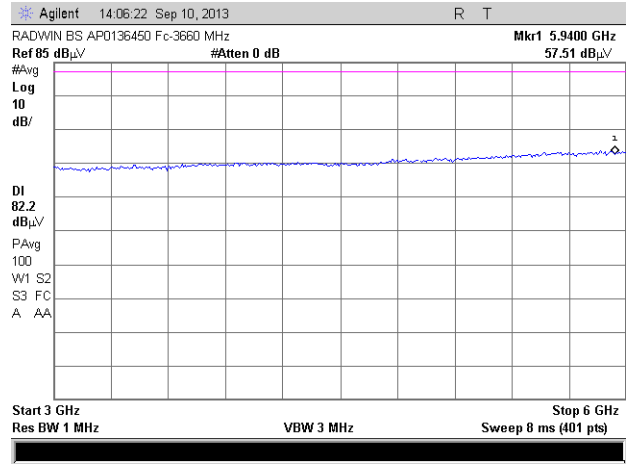

Plot # 163.

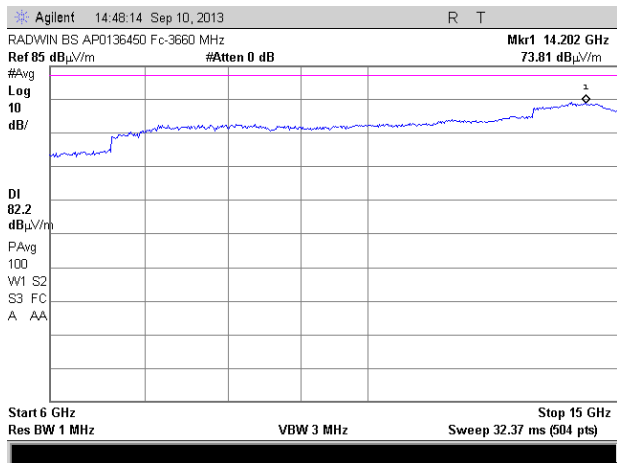

Plot # 164.

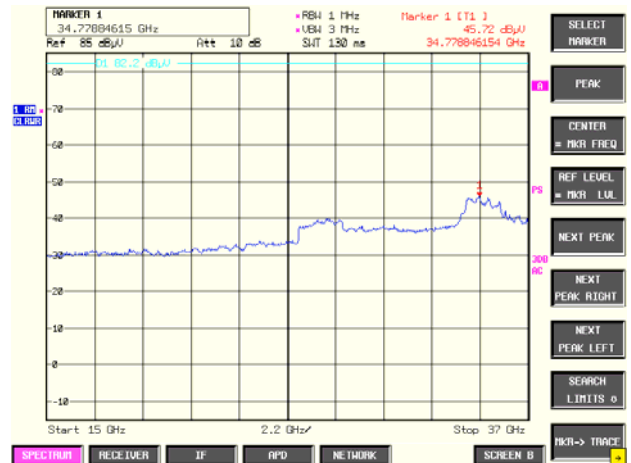

Plot # 165.



Test report No: 9312329195

Page 53 of 70 Pages

Title: 3.6 GHz Transceiver.

Model: Radio module AP0136450 FCC ID: Q3KRW3XMOD/ IC: 5100A-RW3XMOD

3675 MHz carrier frequency.

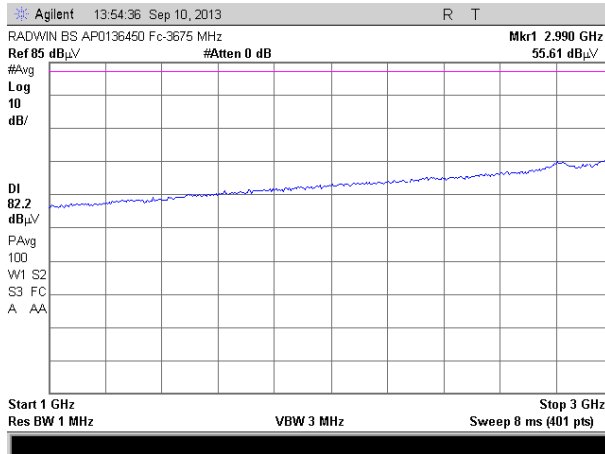

Plot # 166.

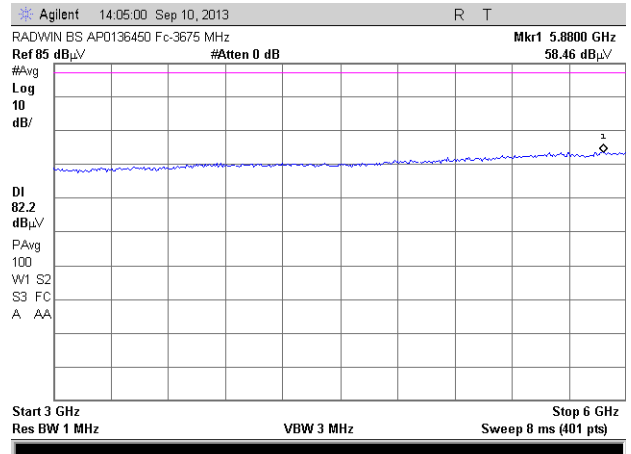

Plot # 167.

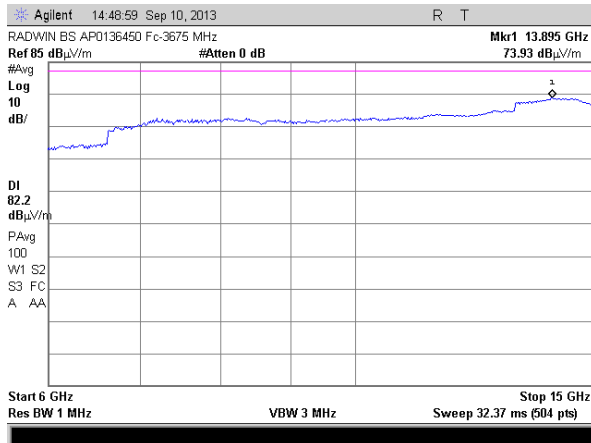

Plot # 168.

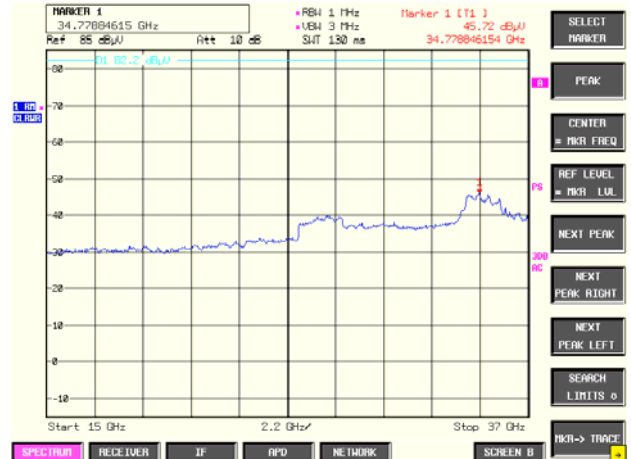

Plot # 169.



Test report No: 9312329195

Page 54 of 70 Pages

Title: 3.6 GHz Transceiver.

Model: Radio module AP0136450 FCC ID: Q3KRW3XMOD/ IC: 5100A-RW3XMOD

3690 MHz carrier frequency.

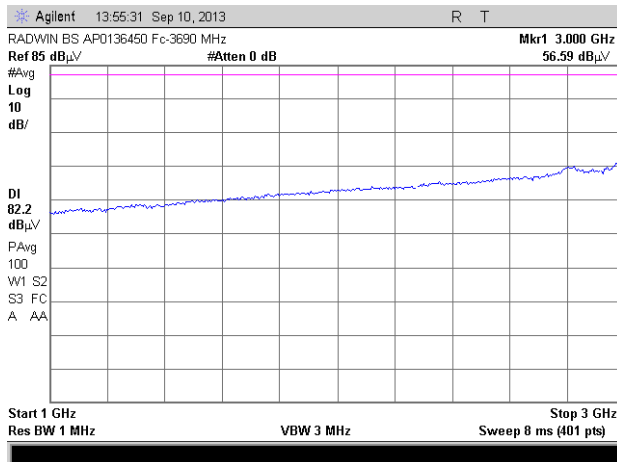

Plot # 170.

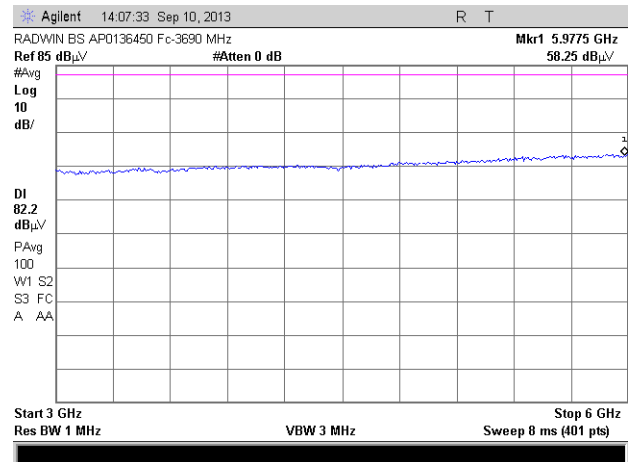

Plot # 171.

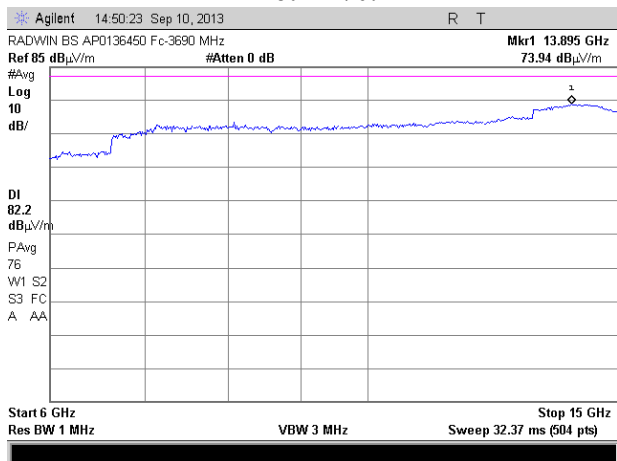

Plot # 172.

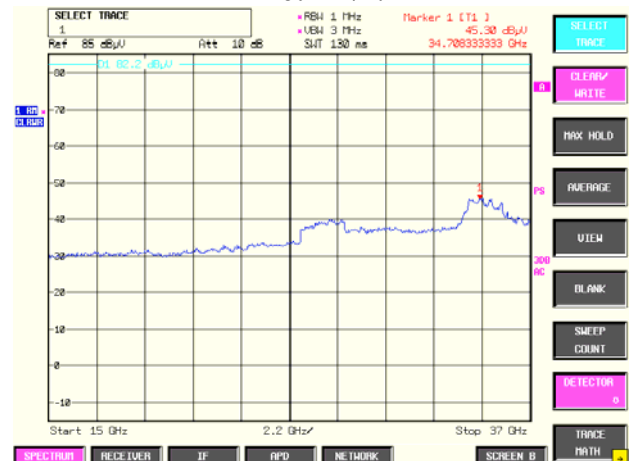

Plot # 173.



Test report No: 9312329195

Page 55 of 70 Pages

Title: 3.6 GHz Transceiver.

Model: Radio module AP0136450 FCC ID: Q3KRW3XMOD/ IC: 5100A-RW3XMOD

40 MHz EBW option. 3670 MHz carrier frequency.

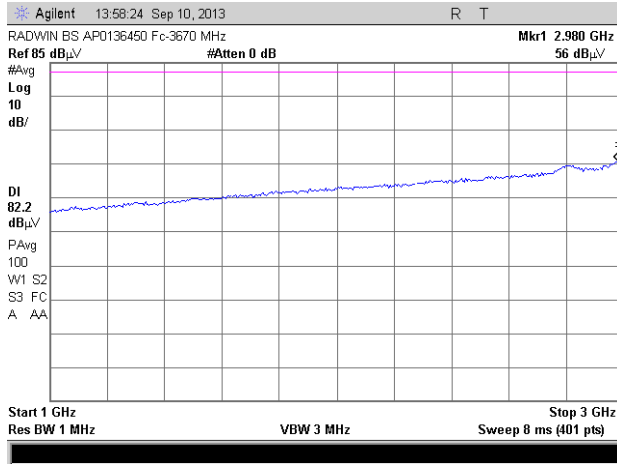

Plot # 174.

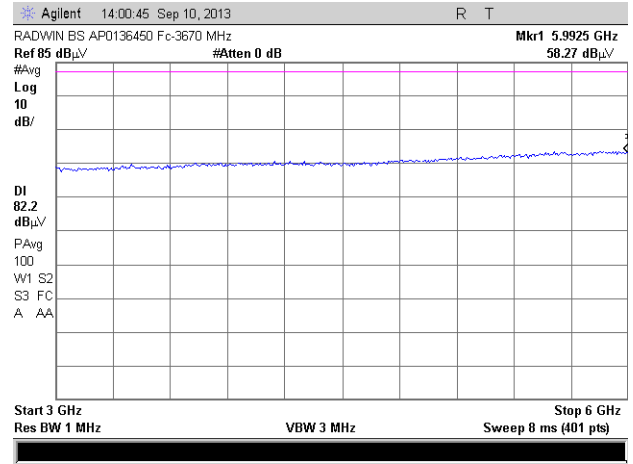

Plot # 175.

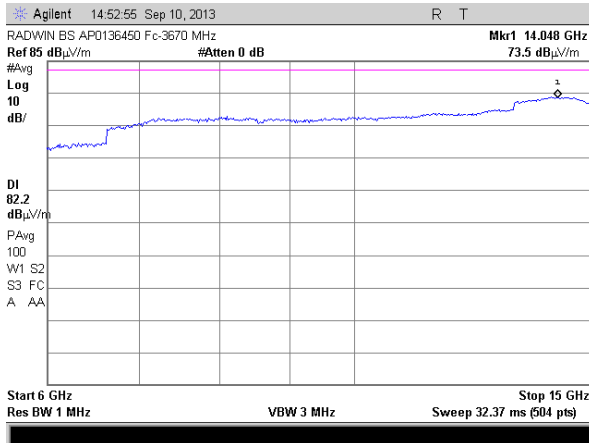

Plot # 176.

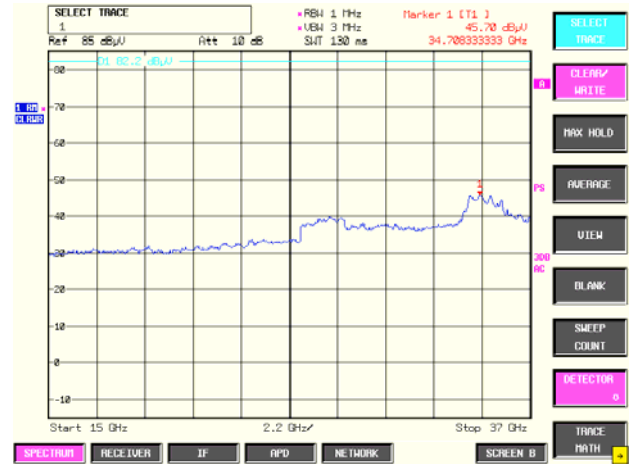

Plot # 177.



Test report No: 9312329195

Page 56 of 70 Pages

Title: 3.6 GHz Transceiver.

Model: Radio module AP0136450 FCC ID: Q3KRW3XMOD/ IC: 5100A-RW3XMOD

3680 MHz carrier frequency.

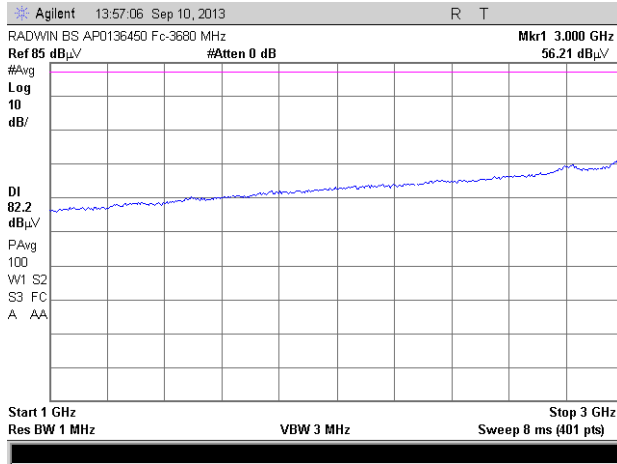

Plot # 178.

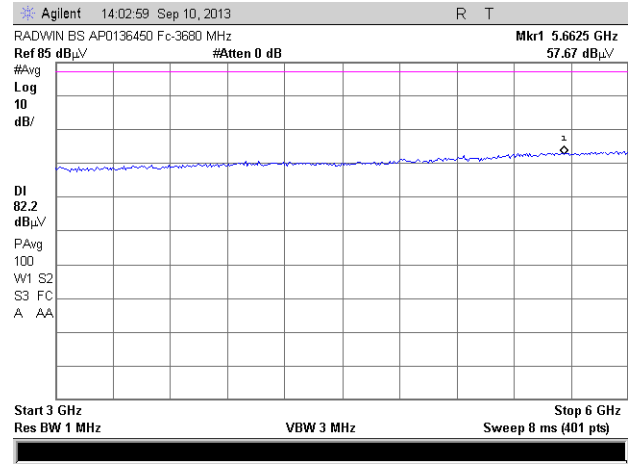

Plot # 179.

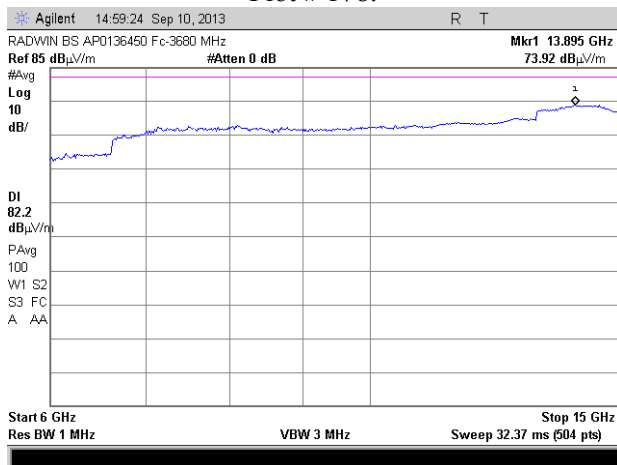

Plot # 180.

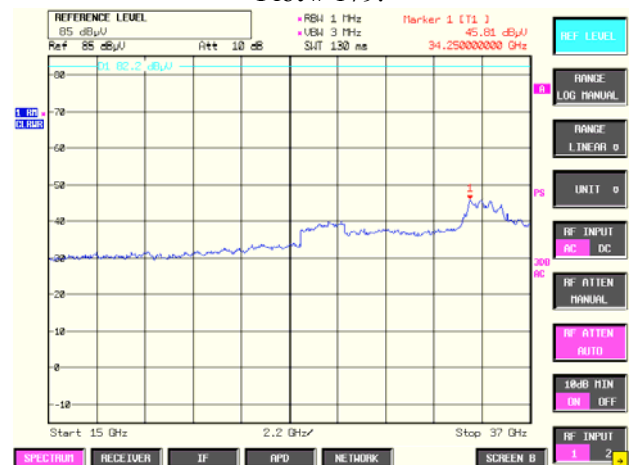

Plot # 181.

**Test report No:** 9312329195**Page 57 of 70 Pages****Title:** 3.6 GHz Transceiver.**Model:** Radio module AP0136450 **FCC ID:** Q3KRW3XMOD/ **IC:** 5100A-RW3XMOD**5.1.6. Frequency stability test according to § 2.1055, RSS-197 section 5.3**

Operating Frequency Range 3.650 – 3.700 GHz
 Ambient Temperature 20⁰C Relative Humidity 56% Air Pressure 1008 hPa

TEST CONDITIONS		Lowest Tx frequency 3652.5 MHz	Frequency deviation (ppm)	Highest Tx frequency 3697.5MHz	Frequency deviation (ppm)
Test temperature	Test voltage				
+25°C	Vmin (102VAC)	3652.5000	0	3697.5000	0
	Vnom (120VAC)	3652.5000	0	3697.5000	0
	Vmax (138VAC)	3652.5000	0	3697.5000	0
-35°C	Vnom (120)	3652.5120	3.2854	3697.5120	3.2454
-25°C	Vnom (120)	3652.5120	3.2854	3697.5120	3.2454
-15°C	Vnom (120)	3652.5088	2.4093	3697.5088	2.38
-5°C	Vnom (120)	3652.5060	1.6427	3697.5060	1.6227
+5°C	Vnom (120)	3652.5020	0.5476	3697.5020	0.5409
+15°C	Vnom (120)	3652.4960	-1.0951	3697.4960	-1.0818
+35°C	Vnom (120)	3652.4915	-2.3272	3697.4915	-2.2989
+45°C	Vnom (120)	3652.4895	-2.8747	3697.4895	-2.8398
+55°C	Vnom (120)	3652.4875	-3.4223	3697.4875	-3.3807
+60°C	Vnom (120)	3652.4873	-3.4771	3697.4873	-3.4348

TEST PROCEDURE

The EUT was placed in a climatic chamber and allowed to stabilize at 25°C temperature and nominal voltage for at list 15 min. The reference carrier frequency was taken. The input voltage was changed from 85% of nominal to 115%. Frequency changes were noted. The temperature in climatic chamber was varied from -35°C to +60°C. Measured frequencies were noted in table above.

LIMIT

The frequency stability shall be sufficient to ensure that the fundamental emissions stay within the authorized frequency bands of operation.

TEST SUMMERY

Transmitter carrier frequency stay within the authorized frequency bands 3.650 – 3.700 GHz.



Test report No: 9312329195

Page 58 of 70 Pages

Title: 3.6 GHz Transceiver.

Model: Radio module AP0136450 FCC ID: Q3KRW3XMOD/ IC: 5100A-RW3XMOD

6. Receiver characteristics test.

6.1. Receiver spurious emissions test at antenna terminal according to RSS -197 section 5.8

Method of measurement	ANSI C63-4 §12.2.5, RSS – Gen		
Operating Frequency Range	3652.5 – 3697.5 MHz		
Detector used	Peak		
Resolution bandwidth	100 KHz/1 MHz		
Video bandwidth	> RBW		
Output power setting	NA		
Ambient Temperature	24 ⁰ C	Relative Humidity	47% Air Pressure 1007 hPa

Spurious emission at antenna terminal shall not exceed value required in RSS-Gen section 6 (b).

Measured frequency band, MHz	RBW, kHz	Measured level, dBm	Limit, nW/dBm	Verdict
30 - 1000	100	-67.9	2 nW/-57	Comply
1000 - 11500	1000	-61.2	4 nW/-53	Comply

TEST DESCRIPTION:

The measurements were performed in receive mode of the 3650 - 3700 MHz frequency range up to 3 times of highest tunable frequency. The EUT antenna terminal was connected to the Spectrum Analyzer through appropriate attenuator and accounted with cable loss in SA settings.

TEST RESULT:

EUT meets requirements of RSS – Gen section 6 (b)
Test results are presented in a table above and plots ##182, 183



Test report No: 9312329195

Page 59 of 70 Pages

Title: 3.6 GHz Transceiver.

Model: Radio module AP0136450 FCC ID: Q3KRW3XMOD/ IC: 5100A-RW3XMOD

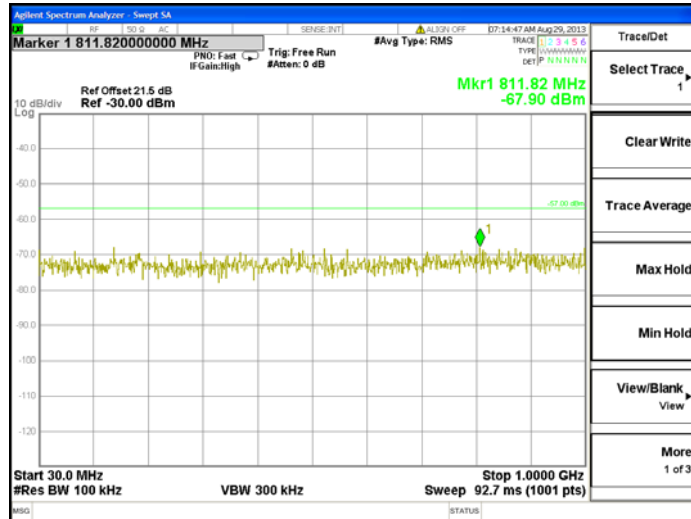

Plot # 182.

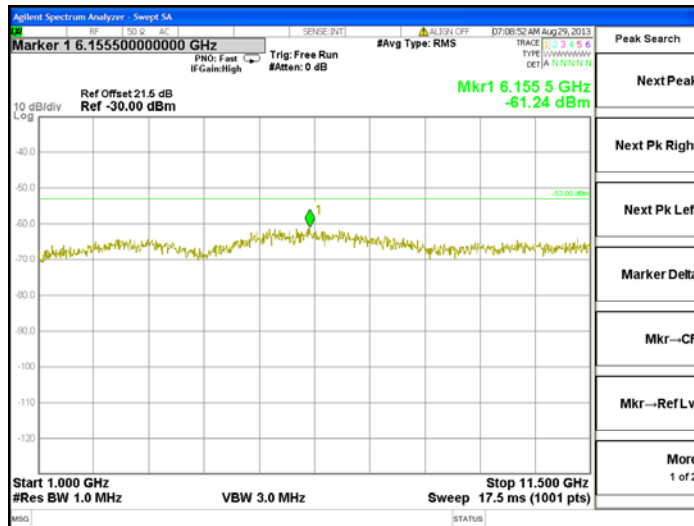

Plot # 183.

**Test report No:** 9312329195**Page 60 of 70 Pages****Title:** 3.6 GHz Transceiver.**Model:** Radio module AP0136450 **FCC ID:** Q3KRW3XMOD/ **IC:** 5100A-RW3XMOD

6.2. Receiver spurious emissions radiated according to RSS -197 section 5.8

Method of measurement	ANSI 63.4 §13.1.3			
Ambient Temperature	21 ⁰ C	Relative Humidity	59%	Air Pressure 1007 hPa

TEST DESCRIPTION:

The measurements were performed in Anechoic chamber of SII EMC branch and verified at the Open Area Test Site. The EUT was arranged on a wooden table 0.8 m placed on the turn - table. Investigation of spurious emissions was performed in frequency range from 30 MHz up to 3 times of highest tunable frequency at 1 and 3 m measurement distance. The Biconilog 30 MHz - 2 GHz antenna and Double Ridged Guide 1 GHz – 18 GHz antenna were used. The level was maximized by initially rotating turntable through 360°, varying the antenna height between 1 to 4 m and changing antenna polarization from vertical to horizontal.

REQUIREMENTS:

EUT radiated emission shall not exceed value required in RSS-Gen section 6.2

TEST RESULT:

EUT meets requirements of RSS - Gen
Test results are presented in plots below.



Test report No: 9312329195

Page 61 of 70 Pages

Title: 3.6 GHz Transceiver.

Model: Radio module AP0136450 FCC ID: Q3KRW3XMOD/ IC: 5100A-RW3XMOD

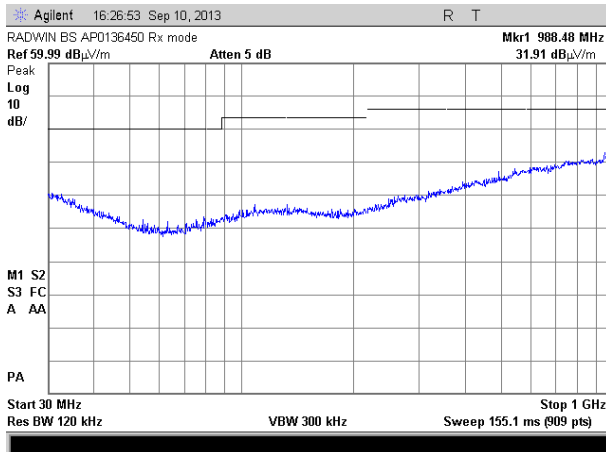

Plot # 184.

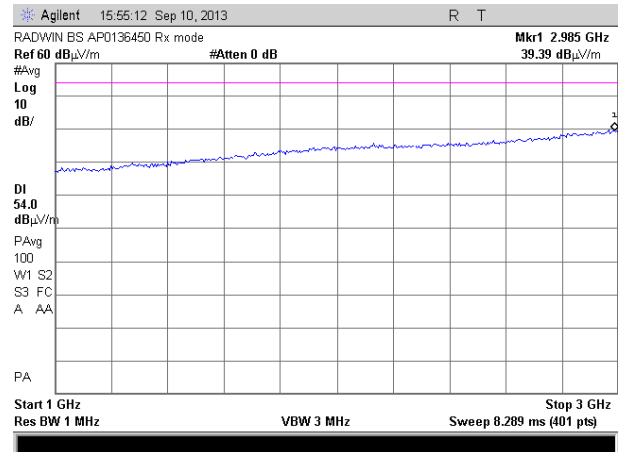

Plot # 185.

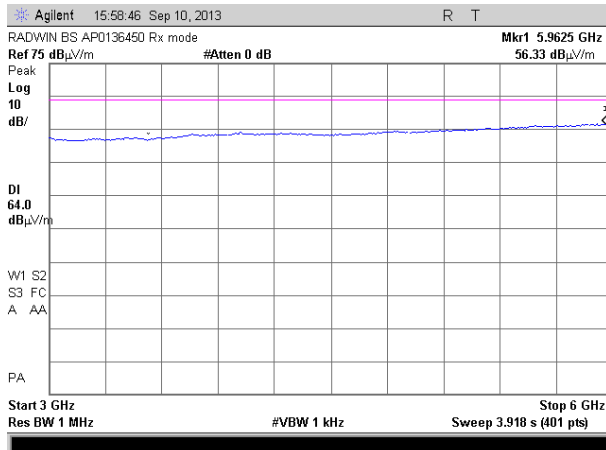

Plot # 186.

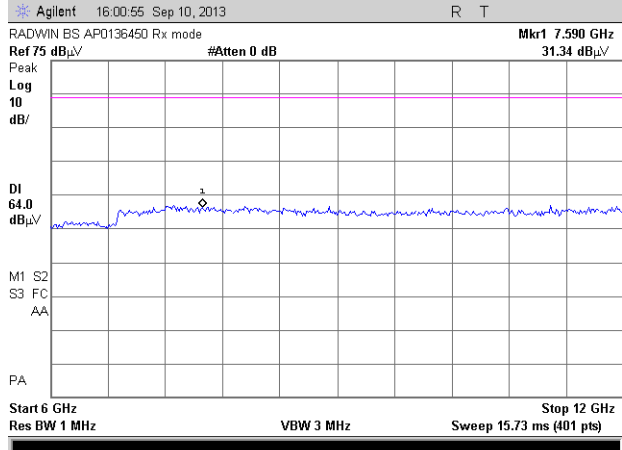

Plot # 187.

Test report No: 9312329195

Page 62 of 70 Pages

Title: 3.6 GHz Transceiver.

Model: Radio module AP0136450 **FCC ID:** Q3KRW3XMOD/ **IC:** 5100A-RW3XMOD

7. APPENDIX A Photographs and additional information.

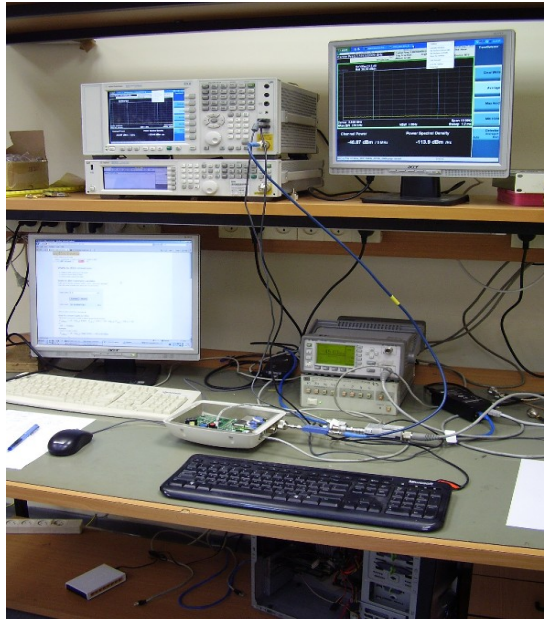

Photo #1. RF conducted measurements test setup.

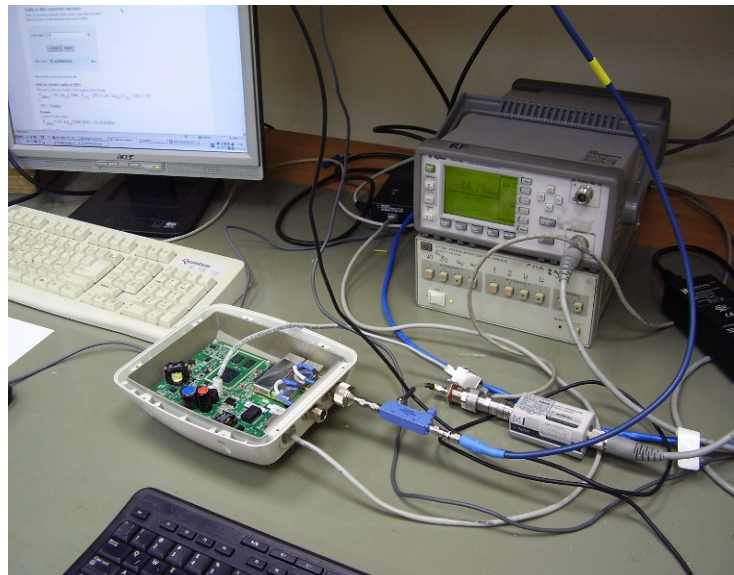

Photo #2. RF conducted measurements test setup.

Test report No: 9312329195

Page 63 of 70 Pages

Title: 3.6 GHz Transceiver.

Model: Radio module AP0136450 **FCC ID:** Q3KRW3XMOD/ **IC:** 5100A-RW3XMOD

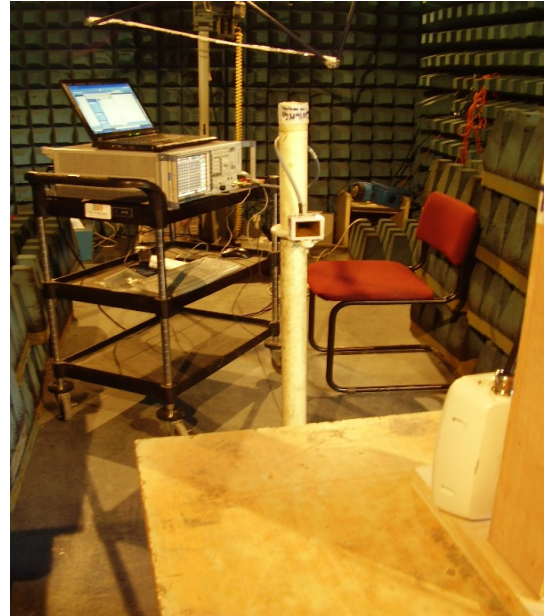

Photo #3. RE investigation setup in anechoic chamber.



Photo #4. RE setup on OATS.



Test report No: 9312329195

Page 64 of 70 Pages

Title: 3.6 GHz Transceiver.

Model: Radio module AP0136450 **FCC ID:** Q3KRW3XMOD/ **IC:** 5100A-RW3XMOD

List of some antennas used by applicant.

Antenna information			
Antenna Type	Manufacturer	Model	Gain, dBi
Dish Dual Pole	RADWIN Ltd.	RW-9722-3338	26
External Flat Panel Dual Pole	RADWIN Ltd.	RW-9612-3338	22
Integrated Flat Panel Dual Pole	RADWIN Ltd.	MT0099910	22
Integrated Flat Panel Dual Pole	RADWIN Ltd.	MT0140780	17
Integrated Flat Panel Dual Pole	RADWIN Ltd.	AM0140450	14
Sector Dual Pole 120Deg	RADWIN Ltd.	RW-9061-3003	15
Sector Dual Pole 90Deg	RADWIN Ltd.	RW-9061-3001	14
All external antennas connected via cables with minimum loss 1dB.			

**Test report No: 9312329195****Page 65 of 70 Pages****Title: 3.6 GHz Transceiver.****Model: Radio module AP0136450 FCC ID: Q3KRW3XMOD/ IC: 5100A-RW3XMOD****8. APPENDIX B Test equipment used****Test equipment used**

No	Description	Manufacturer information			Due calibration date
		Name	Model No	Serial No	
1	EPM Series Power Meter/ E-series sensor 10 MHz - 6 GHz	Agilent	E4418B/ E9301A	MY45109510/ MY41497647	May 2014
2	Spectrum Analyzer EXA 10 Hz – 26.5 GHz	Agilent	N9010A	MY51250920	May 2014
3	Spectrum Analyzer EXA 10 Hz – 26.5 GHz	Agilent	N9010A	MY51250920	May 2014
4	2W attenuator 20 dB, DC – 18.0 GHz	Mini-Circuit	BW-S20W2+	NA	Aug 2014
5	Cable RF 1m	Huber-Suhner	Sucoflex 104	500451/4PE	October 2013
6	Attenuators set (3,6,10,20 dB) DC - 18 GHz	M/A-COM	2082	1650	Aug 2014
7	Double Ridged Guide Antenna 1 – 18 GHz	EMCO	3115	5802	Aug 2014
8	Broadband Horn antenna 15 – 40 GHz	Schwarzbeck Mess-Electronik	BBHA 9170	9170-341	December 2013
9	Antenna Biconilog 30 – 2000 MHz	Schaffner-Chase	CBL6112B	S/N 23181	Aug 2014
10	Spectrum analyzer 10 KHz-26.5 GHz	HP	E7405A	SII 4944	April 2014
11	EMI Receiver 9 kHz-6.5 GHz	HP	8546A+85460A	SII 4068	April 2014
12	LISN 9 kHz – 30 MHz	FCC	LISN 250-32-4-16	SII5023	October 2013
13	Transient limiter 0.009-200 MHz	HP	11947A	3107105	October 2013
14	Cable RF 4m	Huber-Suhner	Sucoflex 104PE	21329/4PE	October 2013
15	Cable RF 0.5m	Huber-Suhner	Sucoflex 104PE	500448/4PE	October 2013
16	Cable RF 1.0m	ENP Connectivity Solutions	X116LCX10040	10-11-002	October 2013
17	Active Loop antenna 10 kHz – 30 MHz	EMCO	6502	SII 4874	October 2013
18	Directional Coupler 20 dB coupling, 2.0 – 8.0 GHz	Pulsar Microwave	CS20-09-436/9	1140	August 2014

**Test report No: 9312329195****Page 66 of 70 Pages****Title: 3.6 GHz Transceiver.****Model: Radio module AP0136450 FCC ID: Q3KRW3XMOD/ IC: 5100A-RW3XMOD****Cable Loss (10m cable + Mast)**

Point	Frequency (MHz)	Cable Loss (dB)	Point	Frequency (MHz)	Cable Loss (dB)
1	30	0.53	21	1000	3.68
2	50	0.75	22	1100	3.82
3	100	1.08	23	1200	4.07
4	150	1.39	24	1300	4.24
5	200	1.61	25	1400	4.43
6	250	1.752	26	1500	4.6
7	300	2.00	27	1600	4.7
8	350	2.15	28	1700	4.85
9	400	2.26	29	1800	4.98
10	450	2.383	30	1900	5.19
11	500	2.52	31	2000	5.34
12	550	2.606	32	2100	5.51
13	600	2.75	33	2200	5.69
14	650	2.856	34	2300	5.89
15	700	3.06	35	2400	6.07
16	750	3.201	36	2500	6.22
17	800	3.27	37	2600	6.28
18	850	3.38	38	2700	6.41
19	900	3.46	39	2800	6.53
20	950	3.55	40	2900	6.84



Test report No: 9312329195

Page 67 of 70 Pages

Title: 3.6 GHz Transceiver.

Model: Radio module AP0136450 FCC ID: Q3KRW3XMOD/ IC: 5100A-RW3XMOD

Biconilog Antenna, Model Number: CBL-6112D, S/N: 23181.

No.	f / MHz)	AF / dB/m	f / MHz)	AF / dB/m	f / MHz)	AF / dB/m	f / MHz)	AF / dB/m
1	30	17.90	170	9.40	530	17.70	1040	22.20
2	32	16.70	175	9.00	540	18.25	1060	22.50
3	34	15.55	180	8.50	550	18.60	1080	22.50
4	36	14.35	185	8.45	560	14.45	1100	22.40
5	38	13.30	190	8.60	570	18.40	1120	22.60
6	40	12.20	195	8.85	580	18.50	1140	22.45
7	42	11.05	200	8.95	590	18.60	1160	22.50
8	44	9.95	205	8.80	600	18.60	1180	22.40
9	46	8.90	210	8.50	610	18.80	1200	22.80
10	48	8.05	215	8.20	620	18.99	1220	22.95
11	50	7.30	220	8.50	630	19.05	1240	23.10
12	52	6.80	225	9.00	640	19.23	1260	23.40
13	54	6.45	230	9.65	650	19.10	1280	23.35
14	56	6.00	235	10.30	660	19.13	1300	23.62
15	58	5.70	240	11.00	670	19.04	1320	23.64
16	60	5.45	245	11.60	680	19.00	1340	23.86
17	62	5.30	250	12.00	690	19.17	1360	23.95
18	64	5.20	255	12.45	700	19.28	1380	23.90
19	66	5.30	260	12.85	710	19.25	1400	24.45
20	68	5.30	265	12.50	720	19.45	1420	24.74
21	70	5.35	270	12.45	730	19.75	1440	24.93
22	72	5.50	275	12.40	740	19.95	1460	25.03
23	74	5.80	280	12.55	750	20.07	1480	25.45
24	76	6.00	285	12.65	760	19.85	1500	25.30
25	78	6.60	290	12.75	770	19.80	1520	25.25
26	80	6.70	295	12.95	780	19.85	1540	25.36
27	82	7.15	300	13.00	790	19.95	1560	25.58
28	84	7.60	310	13.35	800	20.05	1580	25.50
29	86	8.10	320	13.75	810	20.10	1600	25.65
30	88	8.50	330	13.85	820	20.35	1620	25.60
31	90	8.90	340	14.10	830	20.40	1640	25.70
32	92	9.20	350	14.50	840	20.35	1660	25.83
33	94	9.75	360	14.70	850	20.46	1680	25.97
34	96	9.95	370	14.90	860	20.39	1700	26.10
35	98	10.20	380	15.10	870	20.29	1720	26.25
36	100	10.50	390	15.45	880	20.24	1740	26.04
37	105	11.25	400	16.00	890	20.35	1760	26.14
38	110	11.70	410	16.40	900	20.55	1780	26.20
39	115	11.70	420	16.70	910	20.45	1800	26.40
40	120	11.80	430	16.35	920	20.60	1820	26.64
41	125	11.80	440	16.30	930	20.60	1840	26.86
42	130	11.70	450	16.30	940	20.66	1860	27.12
43	135	11.35	460	16.70	950	20.88	1880	27.00
44	140	10.95	470	17.05	960	21.11	1900	27.25
45	145	10.35	480	17.20	970	20.93	1920	27.36
46	150	10.05	490	17.30	980	21.03	1940	27.68
47	155	9.70	500	17.40	990	21.05	1960	27.10
48	160	9.70	510	17.50	1000	21.10	1980	27.06
49	165	9.45	520	17.60	1020	21.40	2000	27.25



Test report No: 9312329195

Page 68 of 70 Pages

Title: 3.6 GHz Transceiver.

Model: Radio module AP0136450 FCC ID: Q3KRW3XMOD/ IC: 5100A-RW3XMOD

Antenna Factor

Double Ridged Guide Antenna mfr EMCO model 3115 1m calibration

Point	Frequency (MHz)	Antenna Factor (dB/m)
1	1000	23.9
2	2000	28.3
3	3000	31.0
4	4000	33.1
5	4500	32.5
6	5000	32.4
7	6000	53.7
8	6500	35.6
9	7000	36.4
10	7500	36.9
11	8000	37.0
12	8500	38.0
13	9000	38.6
14	9500	38.4
15	10000	38.4
16	10500	38.4
17	11000	38.9
18	11500	39.6
19	12000	39.4
20	12500	39.2
21	13000	40.3
22	13500	41.0
23	14000	41.2
24	14500	41.3
25	15000	40.0
26	15500	38.0
27	16000	38.1
28	16500	40.3
29	17000	42.2
30	17500	44.6
31	18000	46.2

Cable Loss

Type: Sucoflex 104PE; Ser.No.21328/4PE; 4 m length

Point	Frequency (GHz)	Cable Loss (dB)
1	0.0-1.0	1.7
2	1.0- 3.5	3.2
3	3.5- 5.5	4.0
4	5.5 - 7.5	4.7
5	7.5 - 9.5	5.3
6	9.5 - 10.5	5.6
7	10.5 - 12.5	6.2
8	12.5 - 14.5	6.8
9	14.5 - 16.5	7.5
10	16.5 - 18.0	8.1



Test report No: 9312329195

Page 69 of 70 Pages

Title: 3.6 GHz Transceiver.

Model: Radio module AP0136450 FCC ID: Q3KRW3XMOD/ IC: 5100A-RW3XMOD

Antenna Factor
Broadband Horn Antenna model BBHA 9170 1m calibration

Point	Frequency, GHz	Antenna Factor (dB/m)
1	15.0	38.5
2	16.0	37.7
3	17.0	38.1
4	18.0	37.9
5	19.0	38.0
6	20.0	38.0
7	21.0	37.9
8	22.0	38.2
9	23.0	39.6
10	24.0	39.6
11	25.0	39.3
12	26.0	39.5
13	27.0	39.6
14	28.0	39.6
15	30.0	40.1
16	32.0	41.2
17	34.0	41.5
18	35.0	41.9
19	36.0	42.2
20	38.0	43.8
21	40.0	43.2

Antenna factor
Active Loop antenna mfr.EMCO mod. 6502 S/N 3424

Frequency (MHz)	Magnetic Antenna Factor (dBS/m)	Electric Antenna Factor (dB)	Frequency (MHz)	Magnetic Antenna Factor (dBS/m)	Electric Antenna Factor (dB)
0.009	-31.46	20.07	1.000	-39.57	11.95
0.010	-32.34	19.18	2.000	-39.84	11.69
0.020	-36.15	15.38	3.000	-40.09	11.44
0.050	-38.57	12.96	4.000	-40.13	11.40
0.075	-38.78	12.75	5.000	-40.24	11.28
0.100	-39.07	12.46	10.000	-40.26	11.27
0.150	-39.07	12.45	15.000	-40.70	10.83
0.250	-39.18	12.35	20.000	-41.02	10.51
0.500	-39.29	12.24	25.000	-41.94	9.59
0.750	-39.38	12.14	30.000	-43.39	8.14

**Test report No: 9312329195****Page 70 of 70 Pages****Title: 3.6 GHz Transceiver.****Model: Radio module AP0136450 FCC ID: Q3KRW3XMOD/ IC: 5100A-RW3XMOD**

9. APPENDIX C Abbreviations and acronyms

The following abbreviations and acronyms are applicable to this test report:

AC	alternating current
cm	centimeter
dB	decibel
dBm	decibel referred to one milliwatt
dB(μ V)	decibel referred to one microvolt
dB(μ V/m)	decibel referred to one microvolt per meter
EMC	electromagnetic compatibility
EUT	equipment under test
GHz	gigahertz
H	height
Hz	hertz
IDU	Indoor Unit
kHz	kilohertz
L	length
LNA	low noise amplifier
m	meter
Mbps	megabit per second
MHz	megahertz
NA	not applicable
OFDM	Orthogonal Frequency Division Multiple Access
ODU	Outdoor Unit
PRBS	pseudo random binary sequence
QP	quasi-peak
RF	radio frequency
RE	radiated emission
rms	root mean square
W	width

Specification references

47 CFR part 90: 2013	Private Land Mobile Radio Services.
IC Canada RSS-197, 2010	Wireless Broadband Access Equipment Operating in the Band 3650 – 3700 MHz
ANSI C63.4: 2009	American National Standard for Method of Measurements of Radio-Noise Emissions from Low-Voltage Electrical and Electronic Equipment in the Range of 9 kHz to 40 GHz
ANSI/TIA-603-C: 2004	Land Mobile FM or PM Communication Equipment Measurement and Performance.