

# Specification

## Patent Pending

- Part No. : **UWC.20**
- Description : 3-5GHz & 6-9GHz Ultra-Wide Band (UWB) SMD  
Chip Antenna
- Features : SMD UWB Chip Antenna  
For European and USA UWB Applications  
In Channels 1-10
- Uses
- Automotive sensors
  - Smart airbags
  - Precision surveying
  - Smart home and entertainment systems
  - Position Location and Tracking applications

Frequency: 3-5GHz & 6-9GHz

Dims: 12\*12\*3mm

RoHS compliant



## **1. Introduction**

Ultra-Wideband (also known as UWB) is a low power digital wireless technology for transmitting large amounts of digital data over a wide spectrum of frequency bands typically spanning more than 500MHz with very low power for short distances.

The low power requirements of UWB mean increased battery life of sensors and tags leading to reduction in overall operational costs. Taoglas has developed various innovative and new-to-market flexible embedded UWB antennas designed for seamless integration on plastics and using highly flexible micro-coaxial cable mounting while achieving high performance where space is limited. Taoglas UWB antennas have been designed for use with the recently launched Decawave ScenSor DW1000 module and are also compatible with any other UWB sensor modules on the market.

The UWC.20 chip antenna, at 12\*12\*3 mm, is a small form factor Ultra-Wideband (UWB) antenna with high efficiencies across the pulsed UWB communications operational bands. It is mounted to a PCB via standard SMT reflow process. It enables designers to use only one antenna that covers all common UWB commercial bands, namely bands, 1 through 10 simultaneously.

The UWC.20 antenna is a durable ceramic antenna that has a peak gain of 4dBi, an efficiency of more than 60% across the bands and is designed to be mounted directly onto a PCB. It is an ideal choice for any device maker that needs to keep manufacturing costs down over the lifetime of a product. Like all such antennas, care should be taken to mount the antenna at least 3mm from metal components or surfaces, and ideally 5mm for best Radiation efficiency. Minimum recommended ground plane size is 31 mm x 25 mm, and antenna to ground clearance for optimum performance is 2.4 mm (please see Section 5.2).

## 1.1. Applications of Pulsed UWB antenna Technology

**Radar**-These short-pulsed antennas provide very fine range resolution and precision distance and positioning measurement capabilities. UWB signals enable inexpensive high definition radar antennas which find use in automotive sensors, smart airbags, and precision surveying applications amongst many others.

**Home Network Connectivity**- Smart home and entertainment systems can take advantage of high data rates for streaming high quality audio and video contents in real time for consumer electronics and computing within a home environment.

**Position location & Tracking**- UWB antennas also find use in Position Location and Tracking applications such as locating patients in case of critical condition, hikers injured in remote areas, tracking cars, and managing a variety of goods in a big shopping mall. UWB offers better noise immunity and better accuracy to within a few cm compared to current localization technologies such as Assisted GPS for Indoors, Wi-Fi and cellular which are at best able to offer meter level precision. Tethered Indoor positioning UWB systems that measure the angles of arrival of ultra-wideband (UWB) radio signals perform triangulation by using multiple sensors to communicate with a tag device.

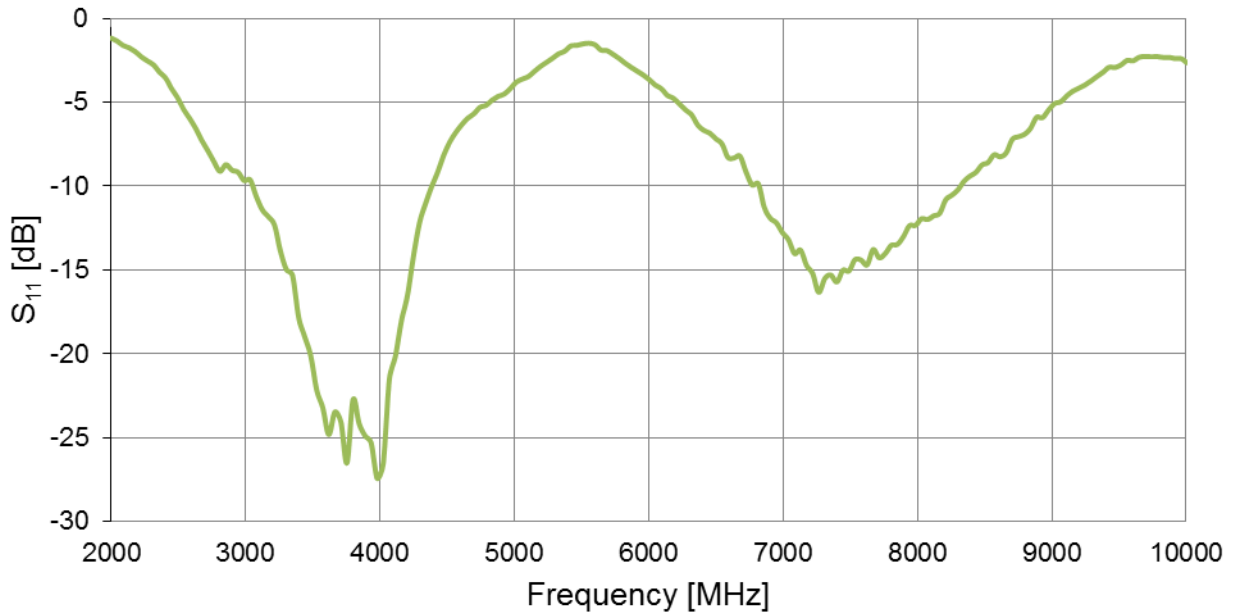
## 2. Specification

ELECTRICAL			
STANDARD	USA UWB channels 1-4	EU UWB/ USA UWB channels 5-8	USA UWB channels 9-10
Operation Frequency (GHz)	3.1–5.0	6.2–8.0	8.0–9.0
Return Loss (dB)	-10	-10	-6
Efficiency (%)	80	70	70
Peak Gain (dBi)	6	3.5	2.5
Max VSWR	2:1	2:1	3:1
Radiation Properties	Omnidirectional		
Polarization	Linear		
Impedance (Ohms)	50		
Max input Power (Watts)	10		
MECHANICAL			
Dimension	12*12*3mm		
Material	Ceramic		
ENVIRONMENTAL			
Operation Temperature	-40°C to 85°C		
Storage Temperature	-40°C to 85°C		
Humidity	40% to 90%		

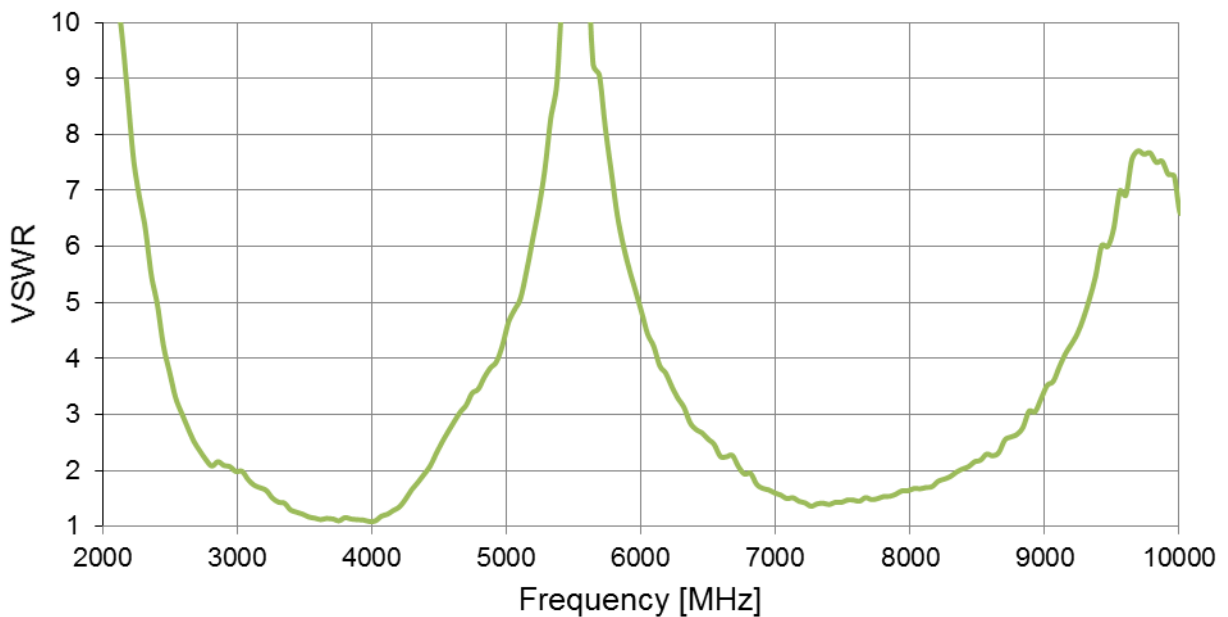
\* Note: Results obtained for antenna on Standard Evaluation Board size 45 mm x 25 mm, with 31 mm x 25 mm ground plane.

### 3. Antenna Characteristics

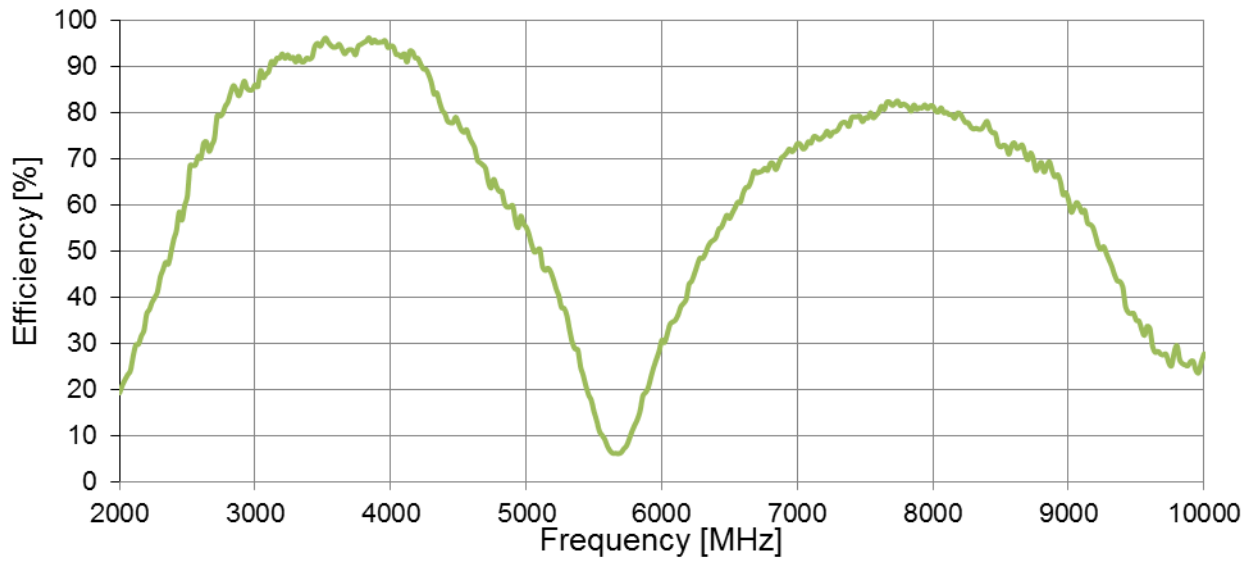
#### 3.1. Return Loss



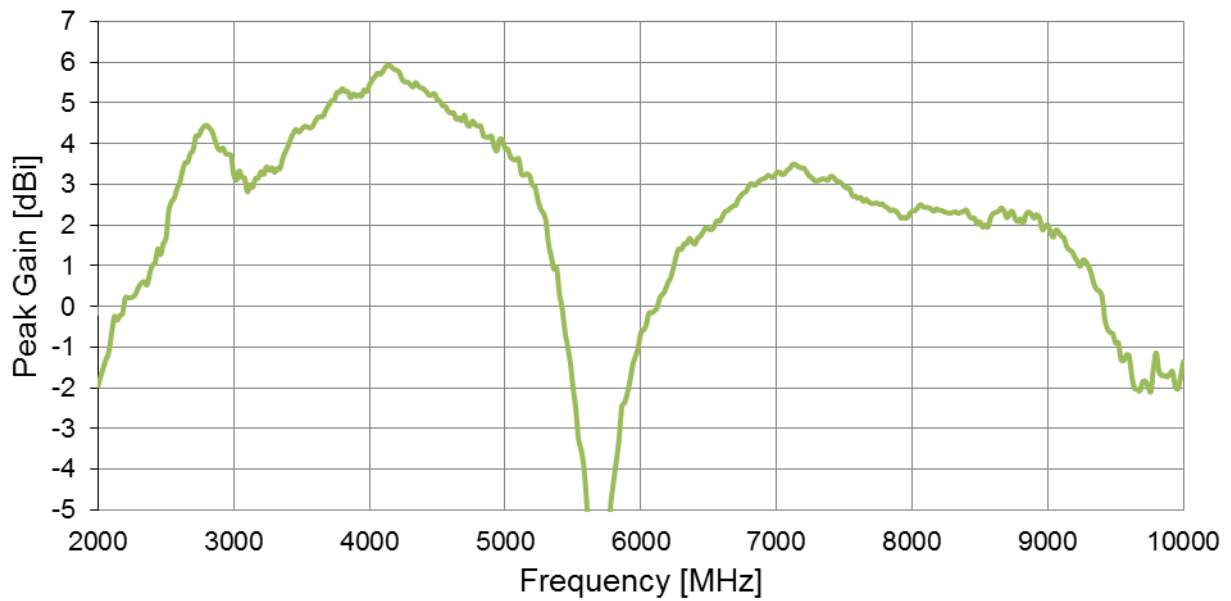
#### 3.2. VSWR



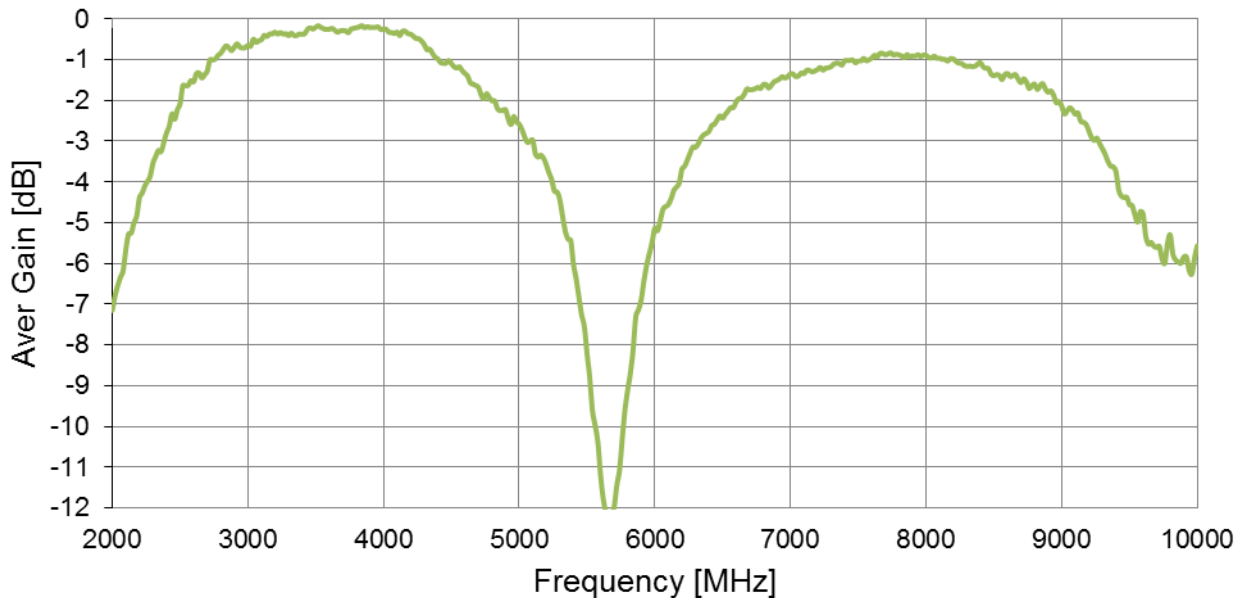
### 3.3. Efficiency



### 3.4. Peak Gain



### 3.5. Average Gain



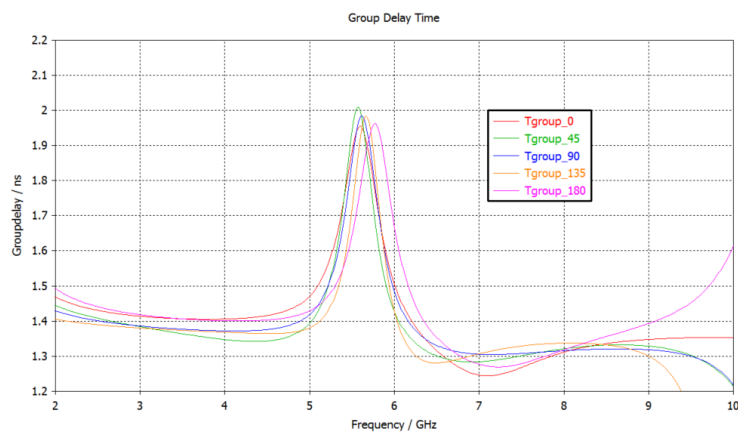
### 3.6. Group Delay (XY Plane) at 6.5GHz

The Total System Group Delay (in seconds) is the total time delay or transmit time of the amplitude envelopes of the various sinusoidal components of UWB signals through a device or link budget system. Effectively it is the propagation delay in transmitting antenna (Tx), propagation channel (Ch), and in receiving antenna (Rx) summed together.

An even more important parameter is the Group Delay Variation over Theta Angle from an average constant group delay. The group delay ripple is used to quantify this deviation. Ultimately, deviations from a maximally flat or constant group delay represent distortions in the output signal which is undesirable. A group delay variation of 100-150ps or less is considered acceptable for UWB system implementation.

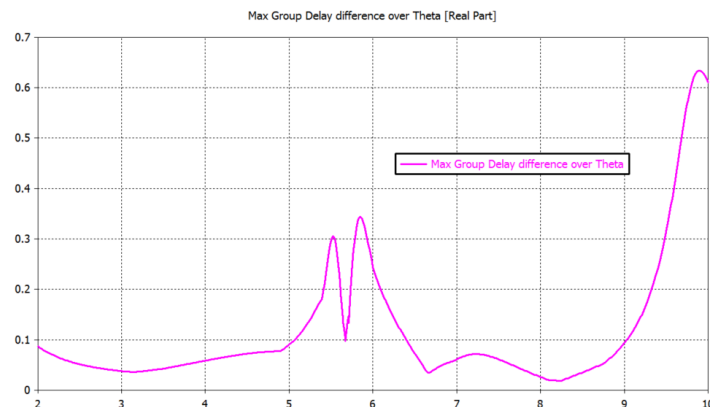
### 3.7. Group Delay Vs Frequency

The group delay was simulated for two UWC.20 antennas placed at a far-field distance of 0.3m. One of the antennas was kept stationary, while the other was rotated in 45° intervals.



### 3.8. Max Group Delay over Theta

The calculated Maximum difference between the highest value and the lowest Group Delay value (in the above graph) is presented below. The UWC.20 antenna presents Group Delay variation smaller than 100 ps (benchmark) from 3GHz to 5GHz and from 6.4GHz to 9GHz spanning UWB channels 1-4 and 6-15. For channel 5 (6-7GHz) the Group Delay variation is between 220 ps (at edge) and 50 ps, which is still considered acceptable.

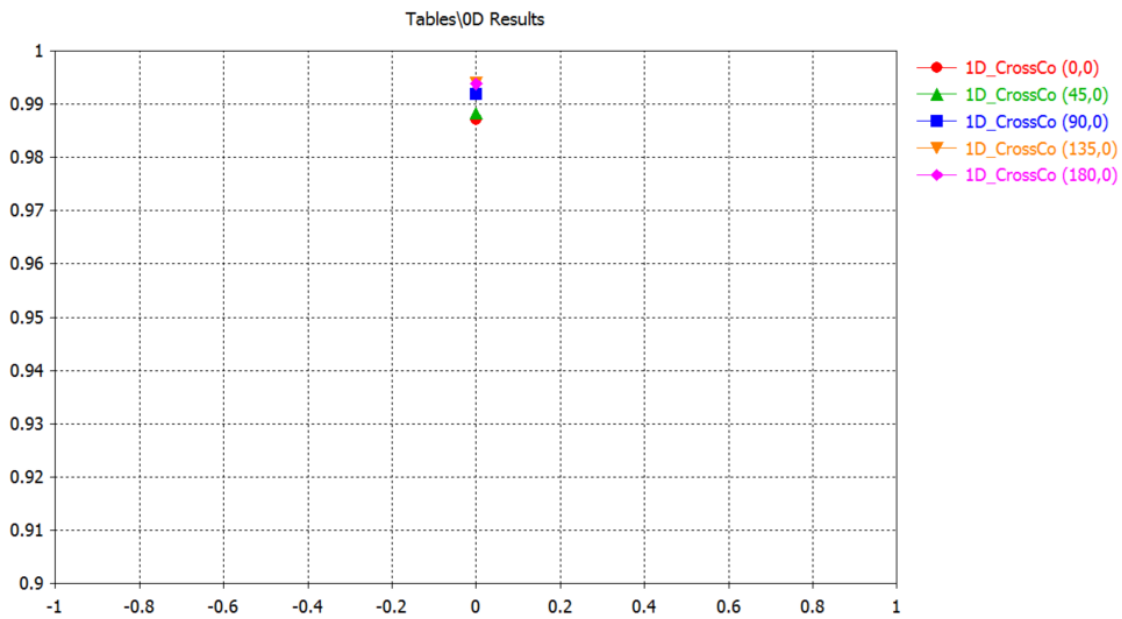




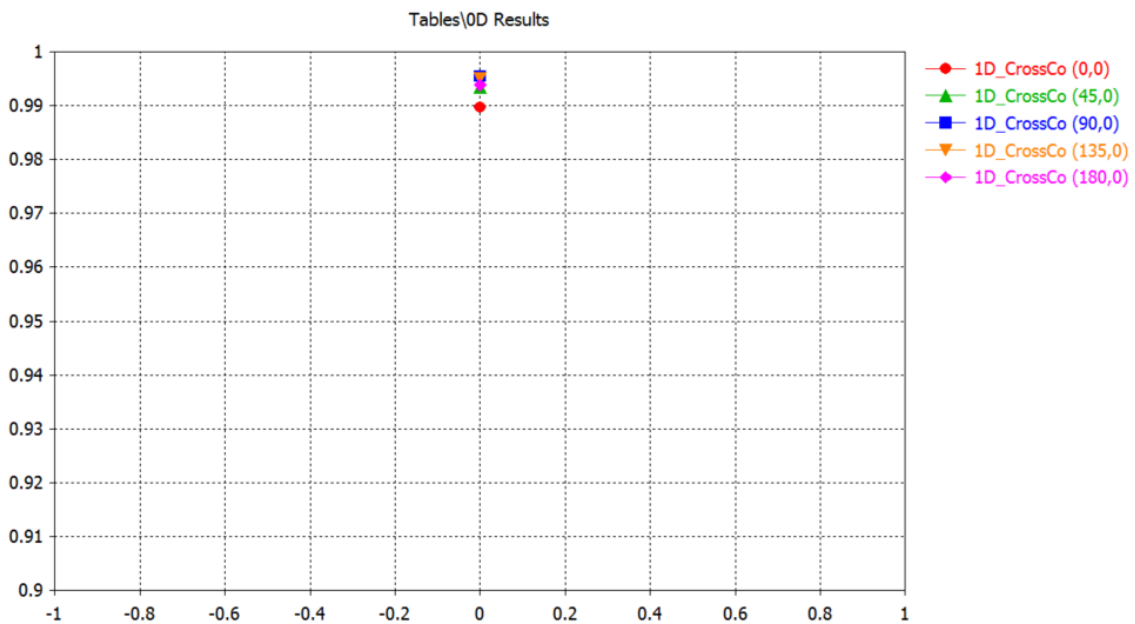
### 3.9. Fidelity Factor vs. Theta Angle

The fidelity is above 0.9 (benchmark value) for all Theta angles, therefore UWC.01 shows very good performance.

#### 3.9.1. Fidelity Factor for 3-5GHz

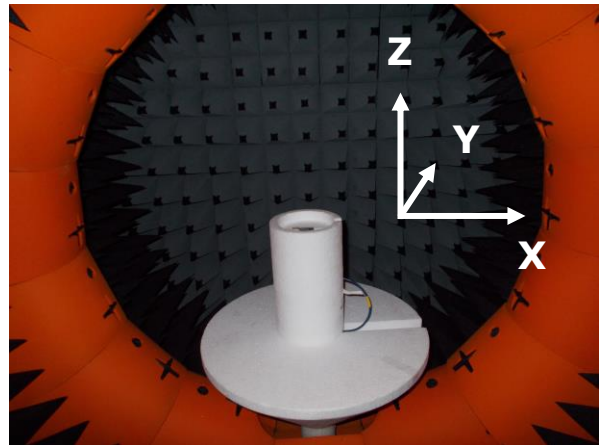
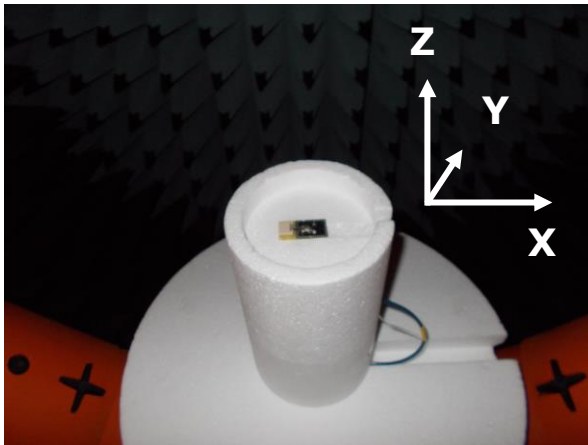


#### 3.9.2. Fidelity Factor for 6-9GHz



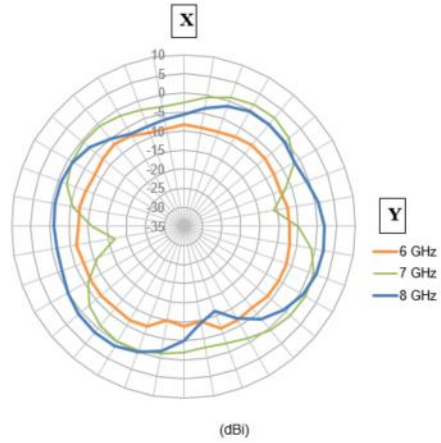
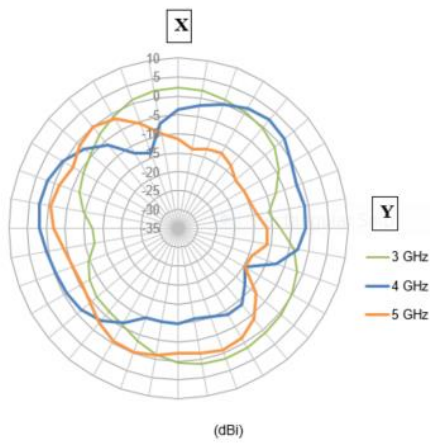
## 4. Antenna Radiation Pattern

### 4.1. Measurement Setup

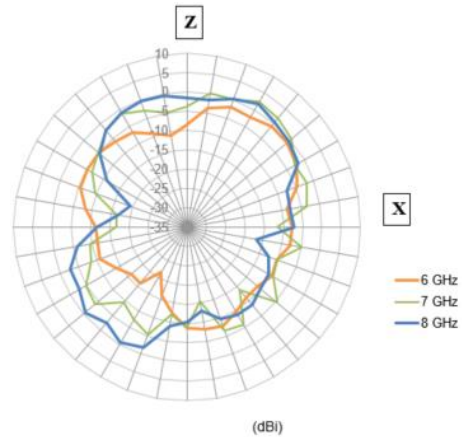
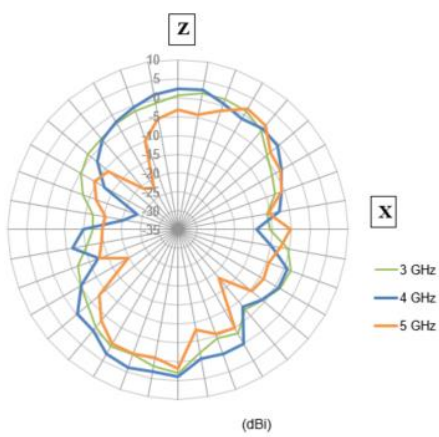


## 4.2. 2D Radiation Pattern (dBi)

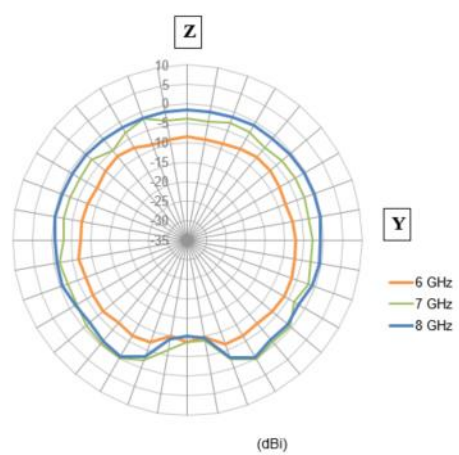
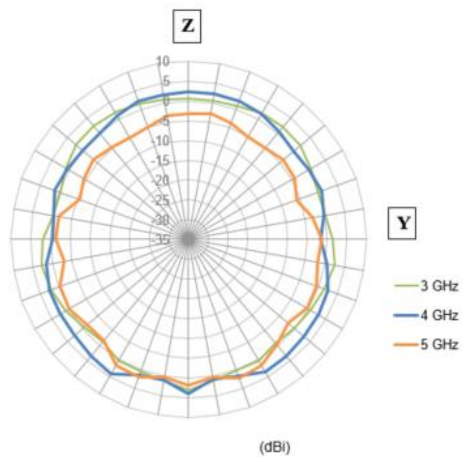
XY Plane



YZ Plane

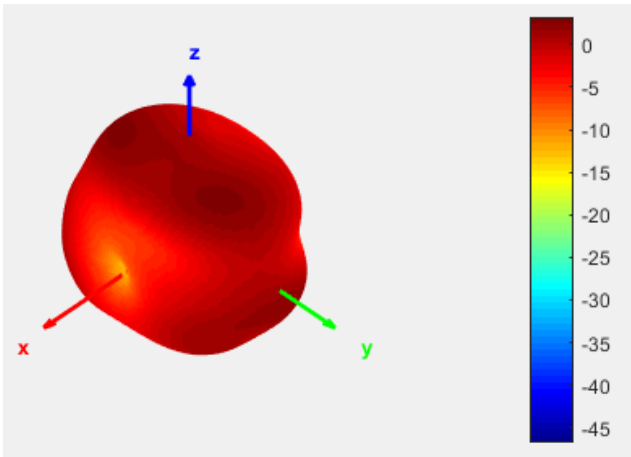


XZ Plane

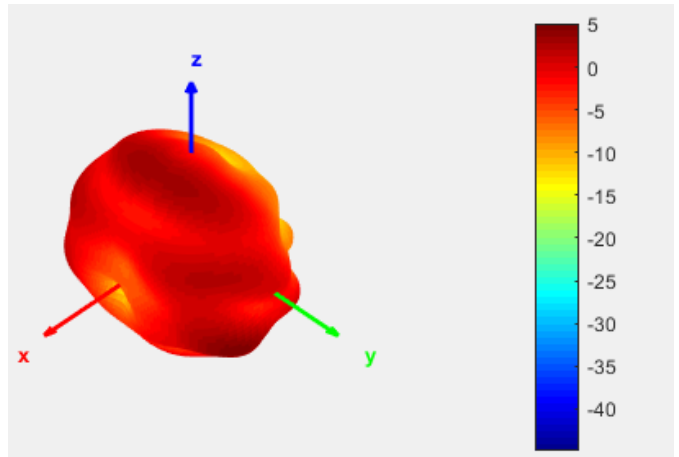


### 4.3. 3D Radiation Pattern (dBi)

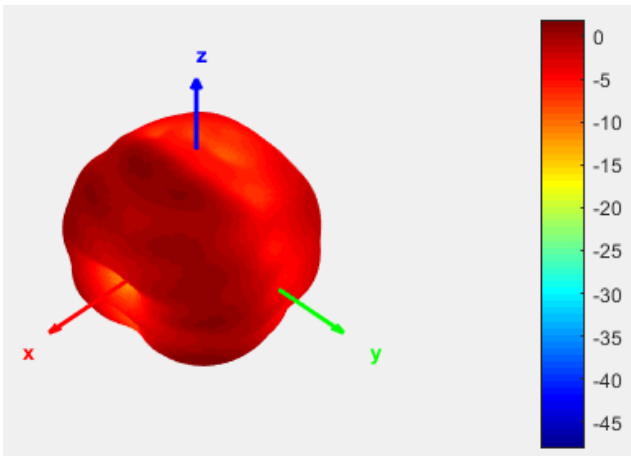
3GHz



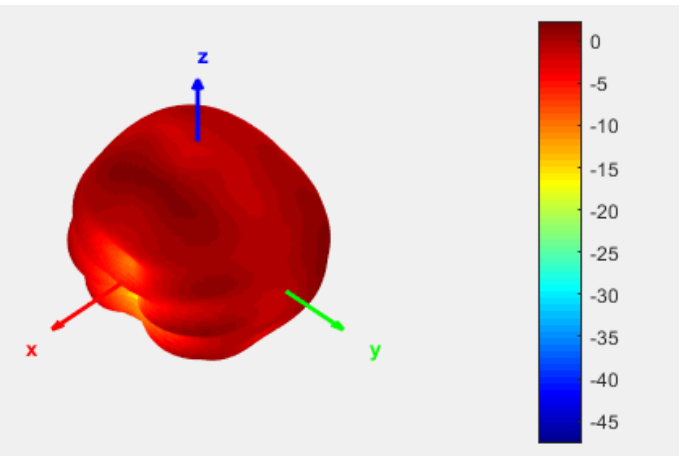
4.5GHz



6.5GHz

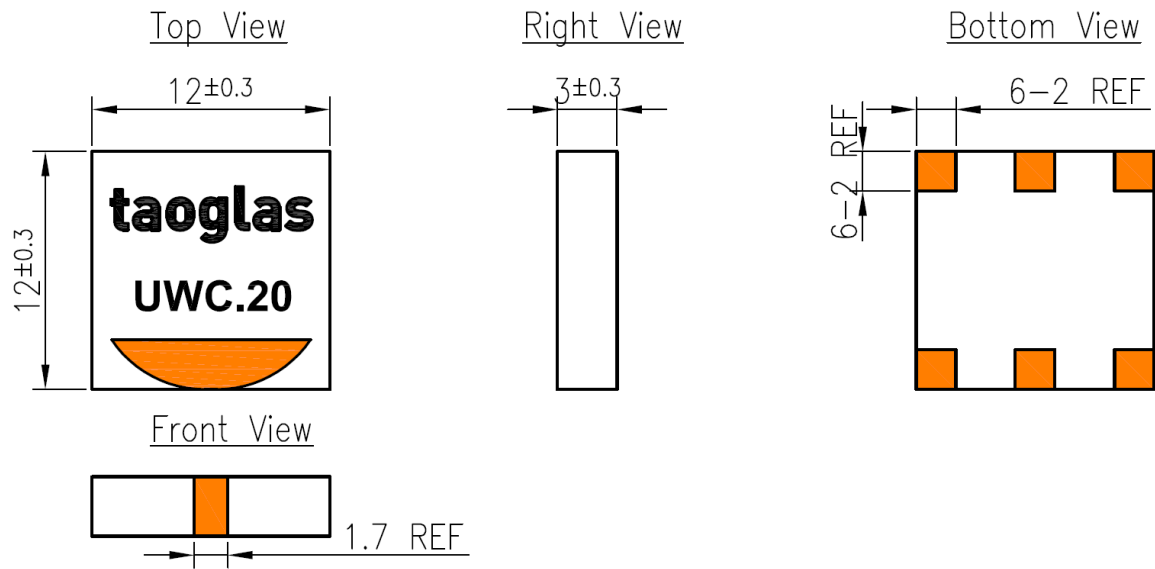


8GHz



## 5. Mechanical Drawing

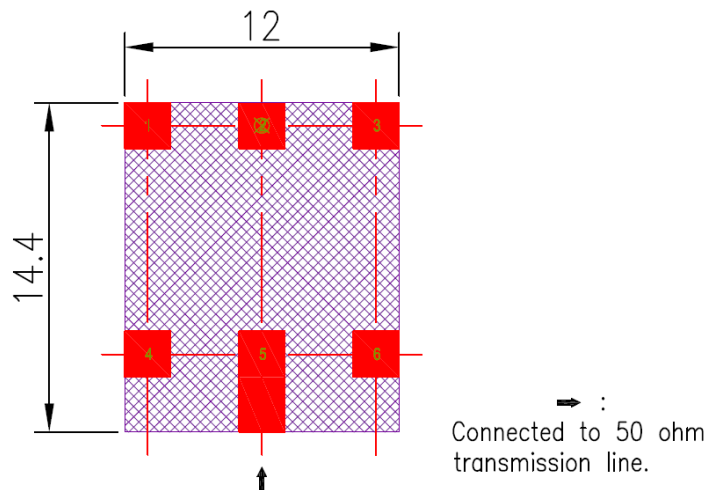
### 5.1. Antenna Drawing (Unit: mm)



## 5.2. Antenna Footprint (Unit: mm)

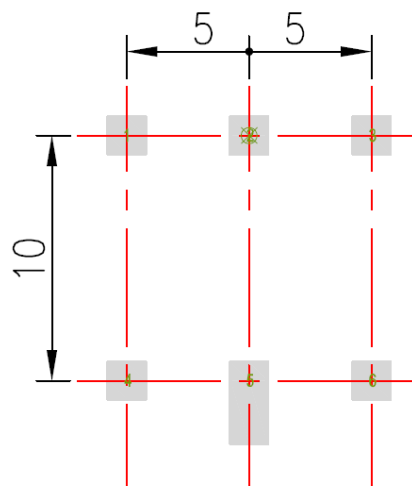
### 5.2.1. Top Copper

Pad 5 should be connected to a 50 ohm transmission line.



### 5.2.2. Top Solder Paste

Pads 1, 2, 3, 4 and 6 are the same size.



**NOTE:**

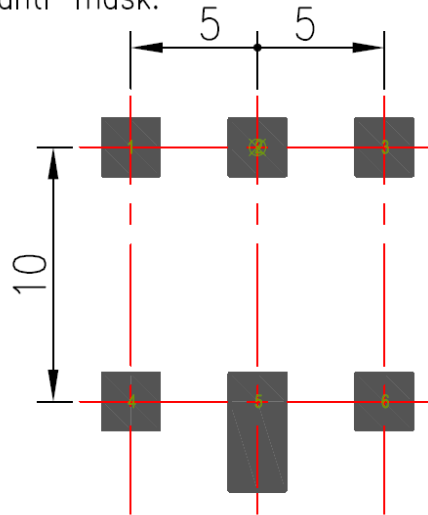
- 1. Ag Plated area
- 2. Solder Mask area
- 3. Copper area
- 4. Paste area
- 5. Copper Keepout Area



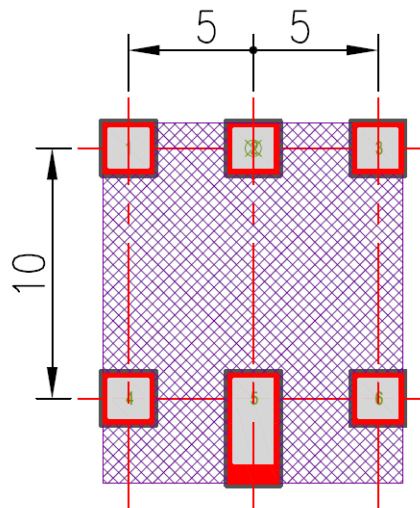
- 6. Ground keepout should extend from top layer through all inner PCB layers to minimize coupling from RF feed to ground.
- 7. Any vias in pads should be either filled or tented to prevent solder from wicking away from the pad during reflow.
- 8. The dimension tolerances should follow standard PCB manufacturing guidelines

### 5.2.3. Top Solder Mask

Pads 1, 2, 3, 4 and 6 are the same size.  
 This drawing is a negative of solder mask.  
 Black regions are anti-mask.



### 5.2.4. Composite Diagram



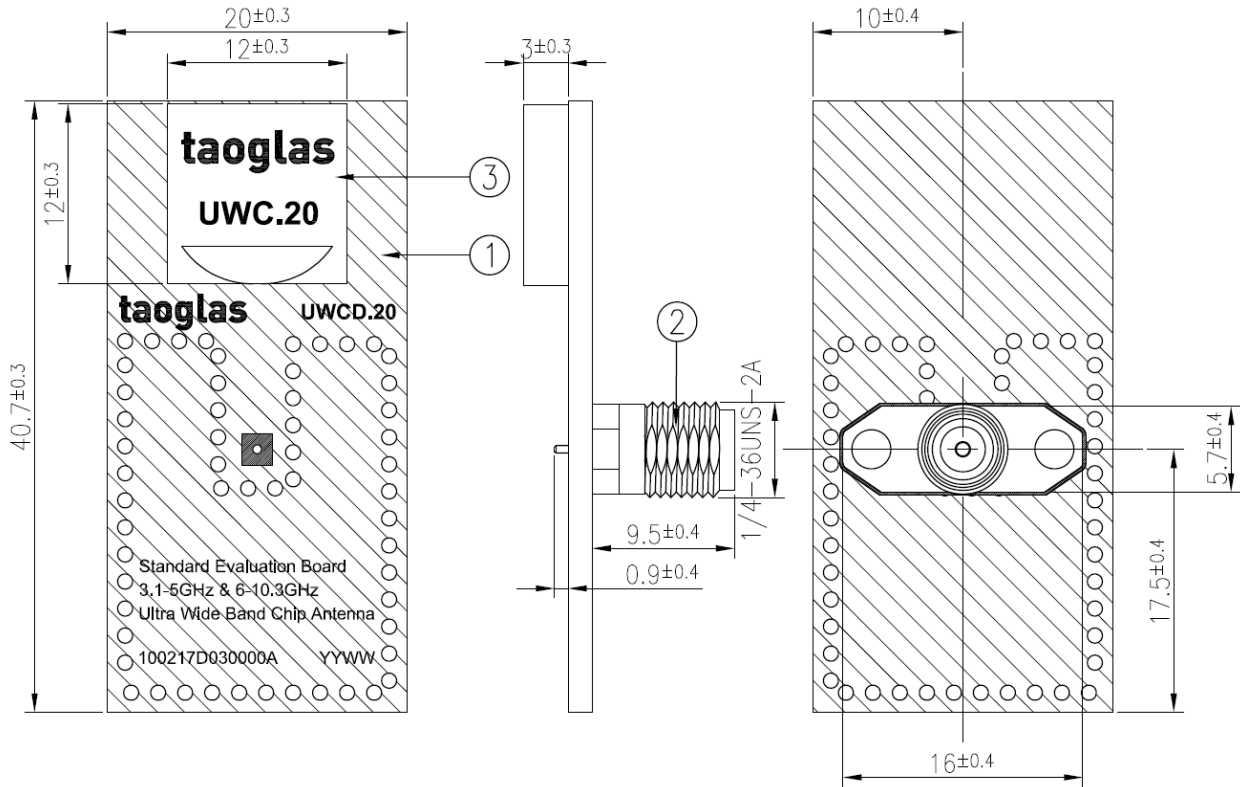
**NOTE:**

- 1. Ag Plated area
- 2. Solder Mask area
- 3. Copper area
- 4. Paste area
- 5. Copper Keepout Area



- 6. Ground keepout should extend from top layer through all inner PCB layers to minimize coupling from RF feed to ground.
- 7. Any vias in pads should be either filled or tented to prevent solder from wicking away from the pad during reflow.
- 8. The dimension tolerances should follow standard PCB manufacturing guidelines

### 5.3. Evaluation Board (UWC20D.01) (Unit: mm)



	Name	Material	Finish	QTY
1	UWCD.20 EVB PCB	Composite 1.6t	Black	1
2	SMA(F)ST	Brass	Au Plated	1
3	UWC.20 Antenna	Ceramic	Nature	1

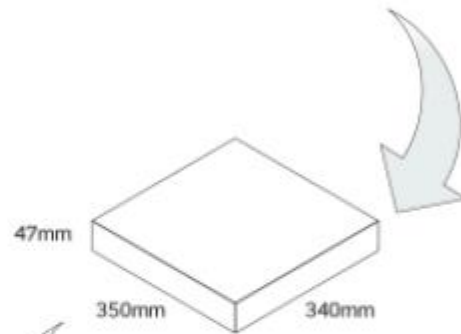




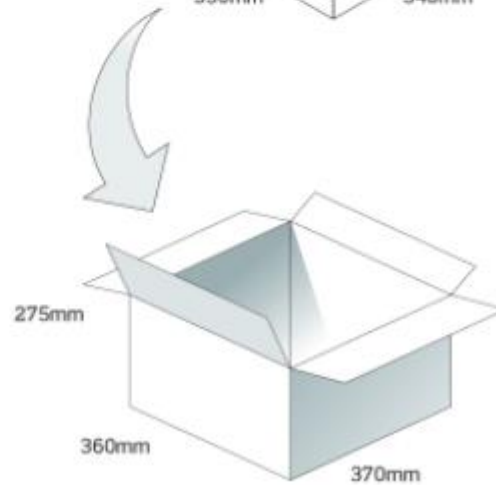
600 pc UWC.20 per reel  
Dimensions - Ø330\*20.4mm  
Weight - 2.46Kg



600 pcs UWC.20 / 1 Reel in small box  
Dimensions - 350\*340\*47mm  
Weight - 2.76Kg



5 small boxes, 3000 pcs in one carton  
Carton Dimensions - 360\*370\*275mm  
Weight - 13.8Kg

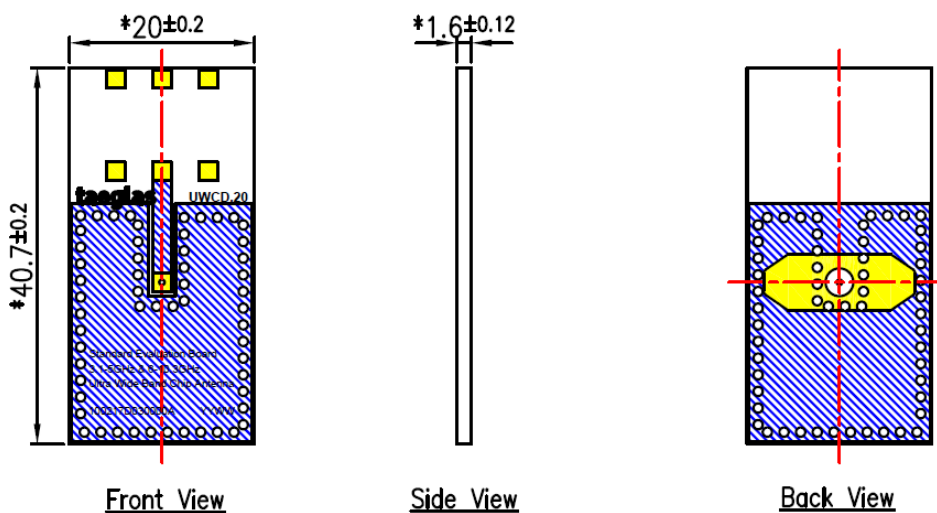


## 7. Application Note

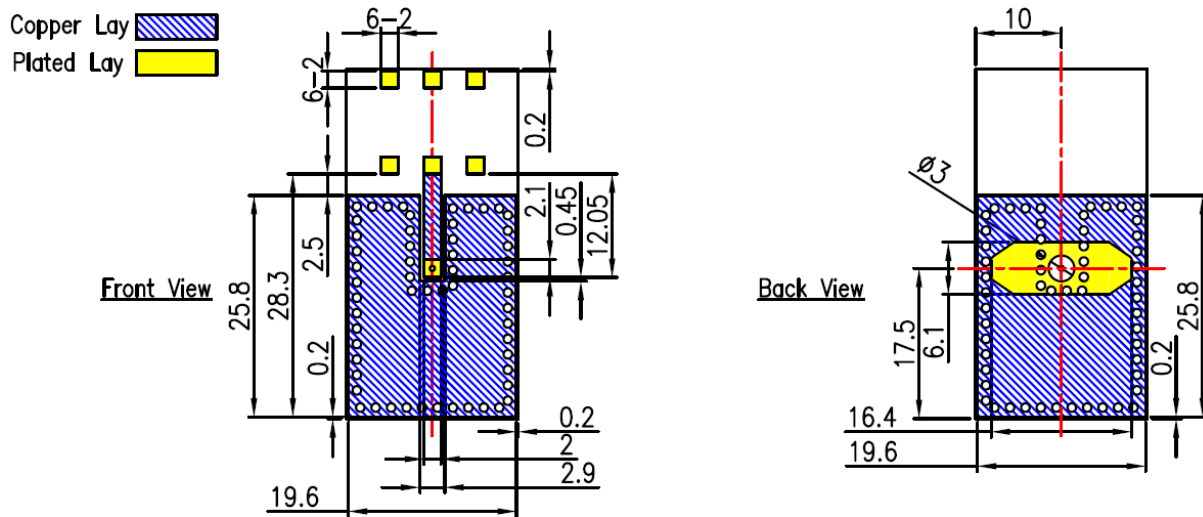
### 7.1. Recommended Placement and Ground Plane Size

The recommended ground plane dimensions and antenna landing pattern are shown below. The gap between the antenna and the ground plane should be fixed at 2.44 mm.

The antenna should be placed in the middle of the ground plane, although offset by 4 mm to one of the sides has shown only small influence on antenna performance.



**Figure 1 Evaluation Board**

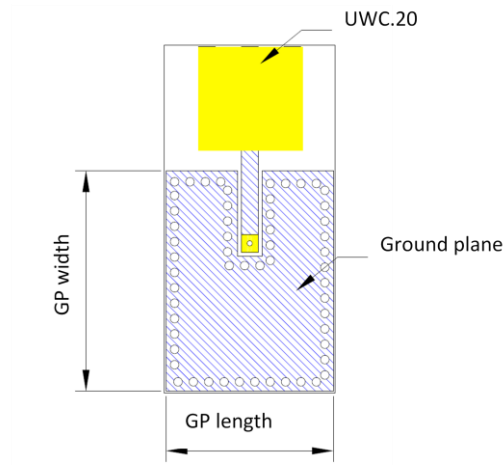


**Figure 2 Detailed dimensions EVB front and back**

## 7.2. Ground Plane Size

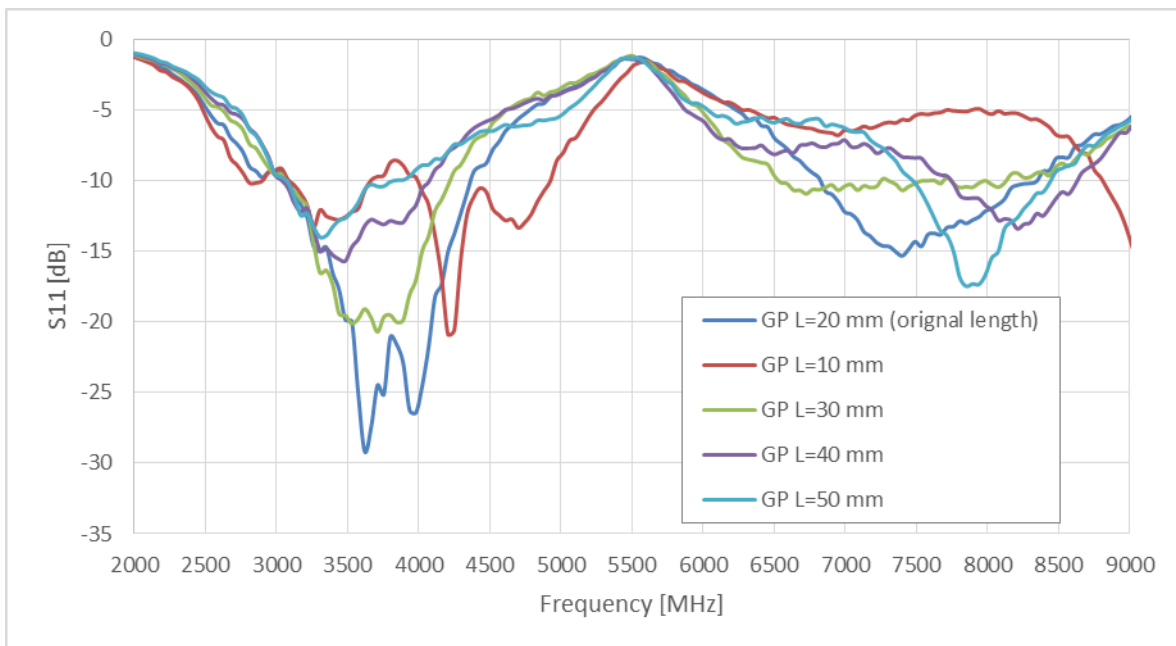
Influence of ground plane length and width is tested. Graphs below show that there is influence on S11 and on Efficiency when the ground plane length is increased in both lower band ( 3 – 5 GHz) and higher band ( 6 – 9 GHz). Results in Figure 4 and Figure 5 should be taken into consideration when choosing the PCB size. Length shorter than 10 mm is not recommended.

When the ground plane width is increased both S11 and efficiency are not significantly influenced, except for width 16 mm which has negative influence on performance in channel 5 (6-7 GHz).

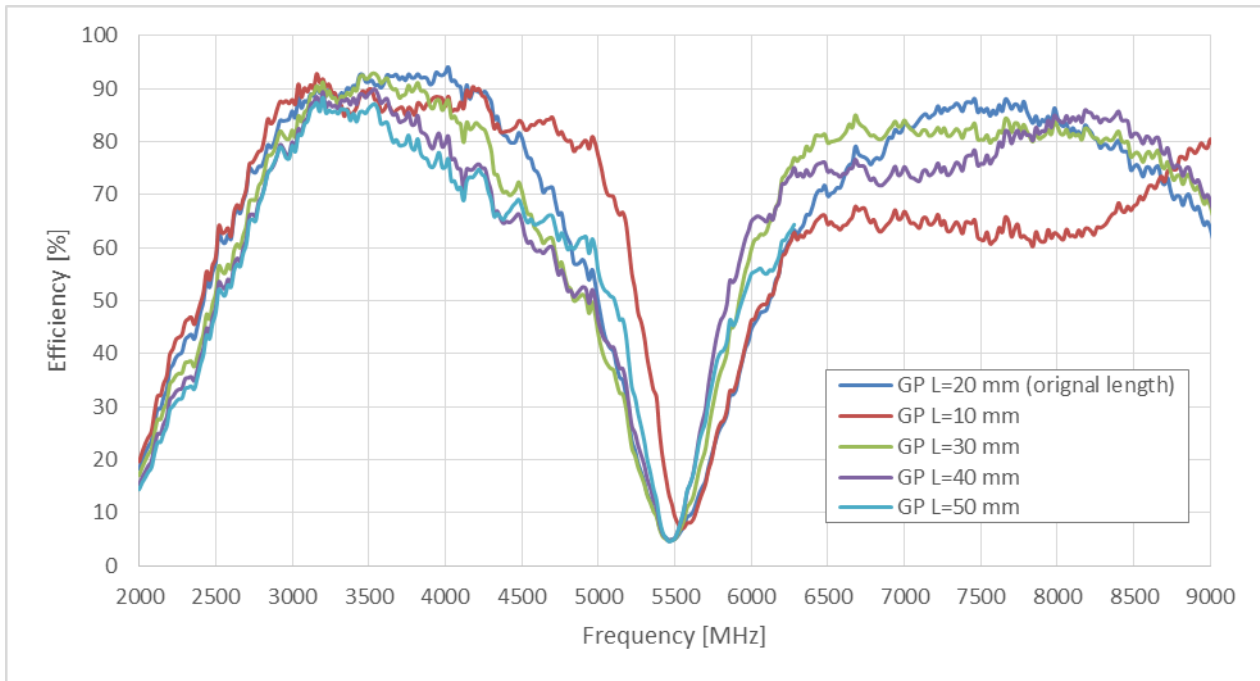


**Figure 3 Evaluation Board Layout**

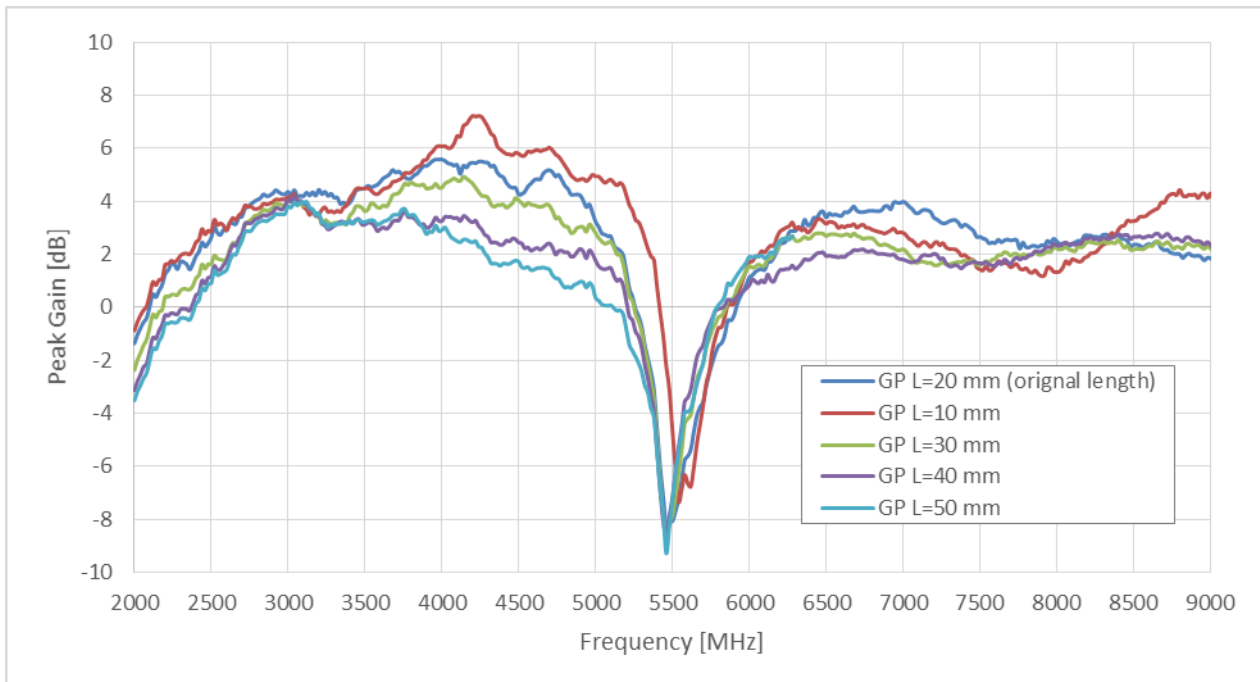
### 7.2.1. Ground Plane Length



**Figure 4 Return loss for ground plane length variation**

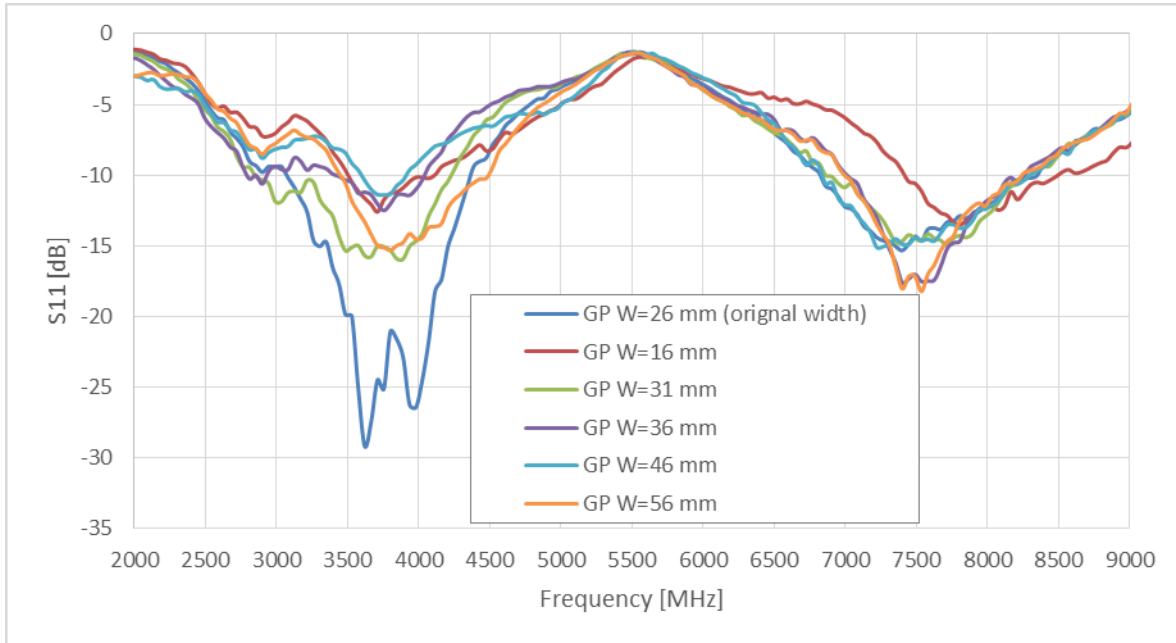


**Figure 5 Efficiency for ground plane length variation**

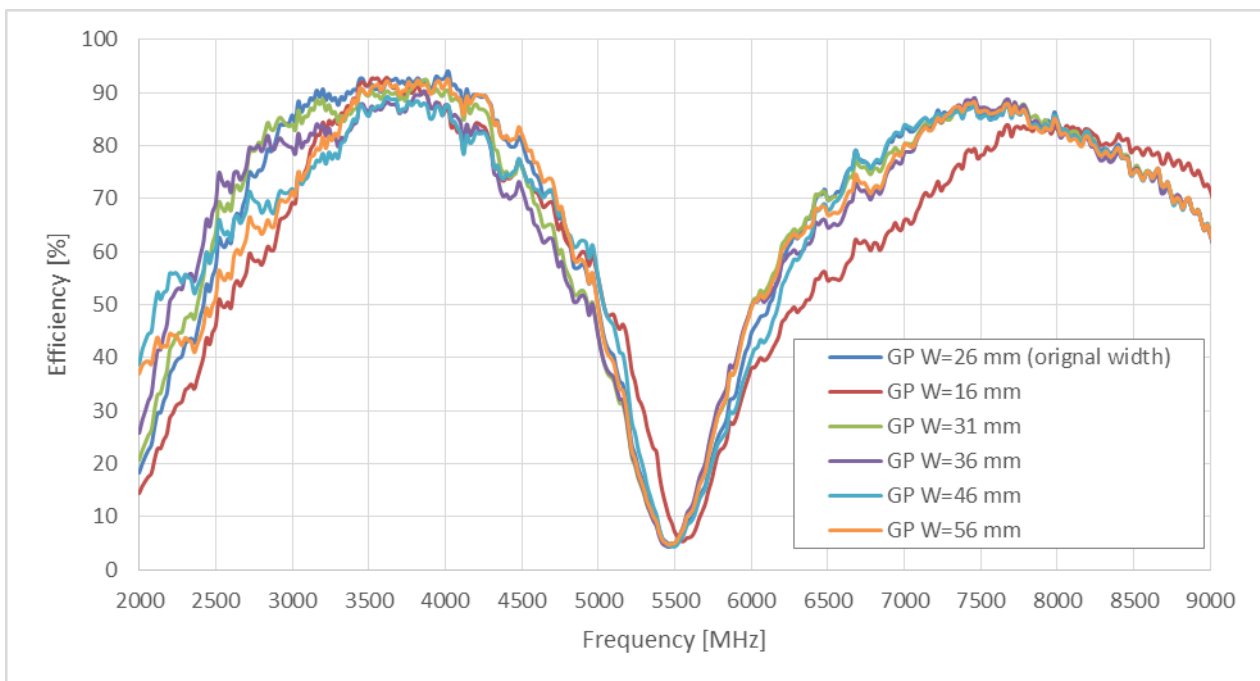


**Figure 6 Peak gain for ground plane length variation**

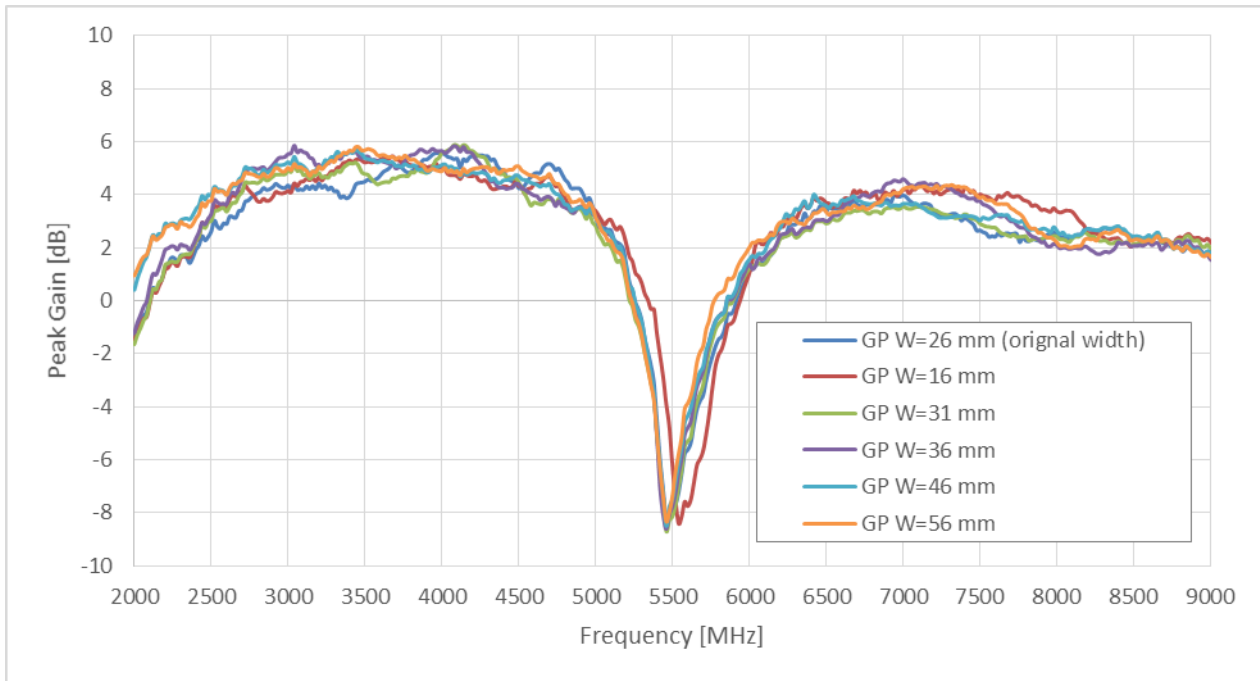
### 7.2.2. Ground Plane Width



**Figure 7 Return loss for ground plane width variation**



**Figure 8 Efficiency for ground plane width variation**



**Figure 9 Peak gain for ground plane width variation**

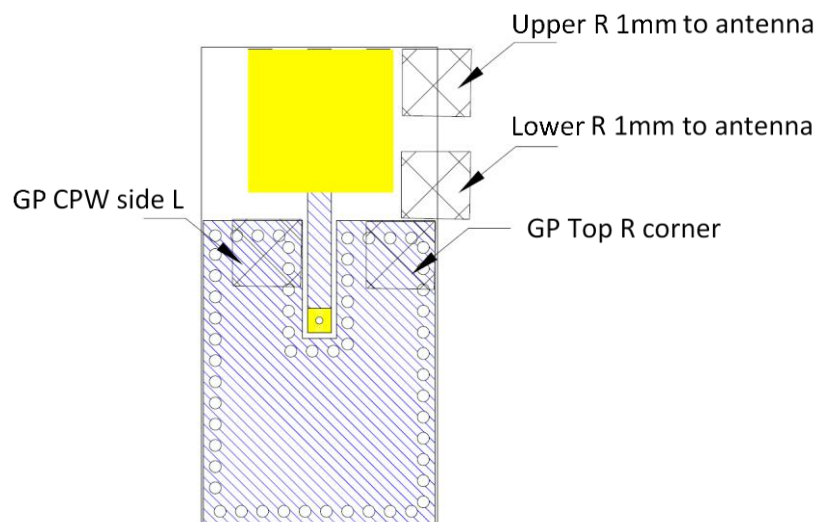


### 7.3. Clearance Study

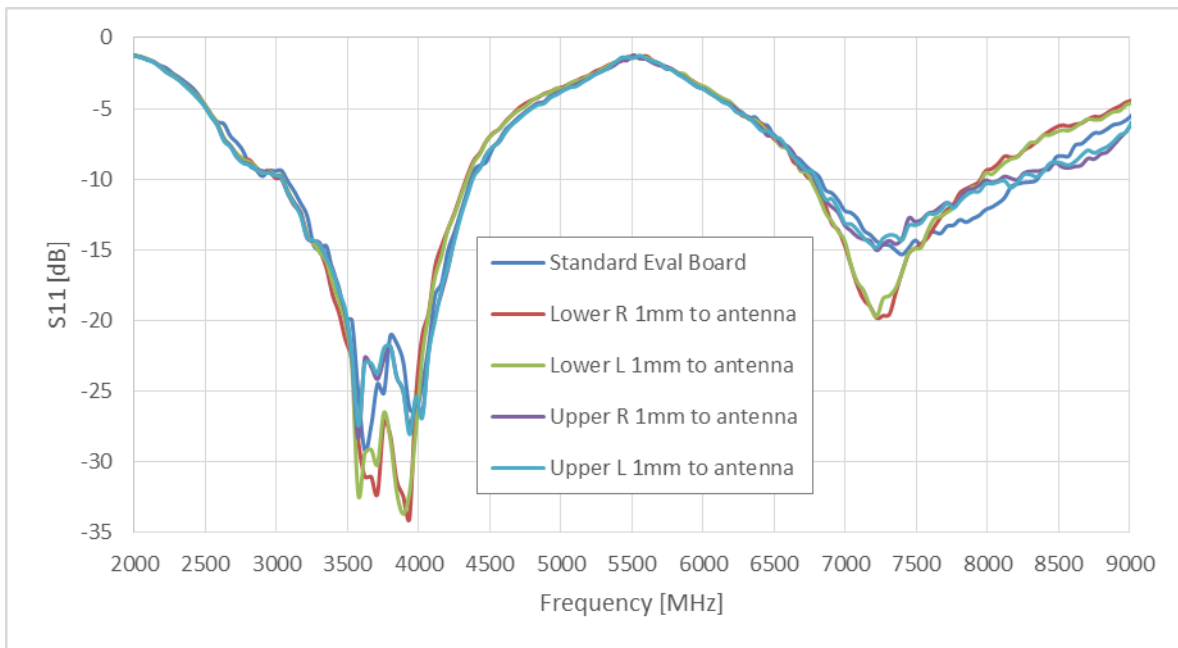
A metal clearance study is also performed. A 5\*5\*2mm metal component is placed on different locations around the UWC.20 antenna as shown in Figure 10.

The results show that close proximity of components on the left and right of the antenna will not influence performance, nor as will a component placed on the ground plane edge below the antenna. Note that clearance between the antenna and ground plane shall be kept at 2.44 mm.

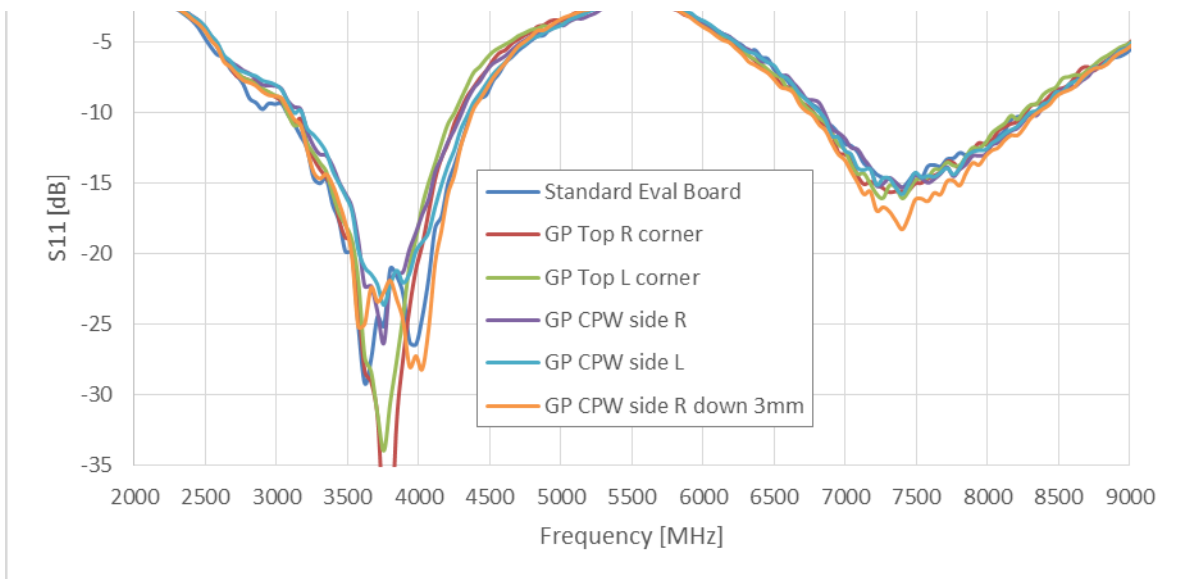
From this follows that for optimum performance it is advised to keep any component at least 1 mm from the antenna.



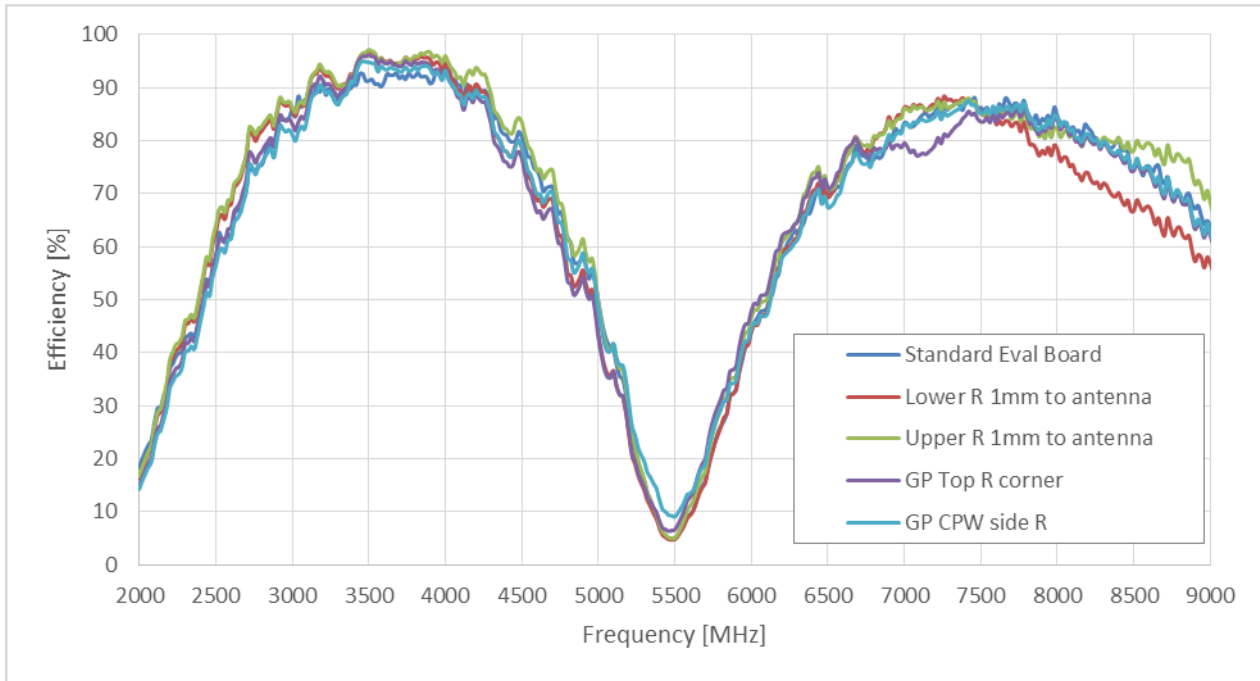
**Figure 10 Clearance study - metal component locations**



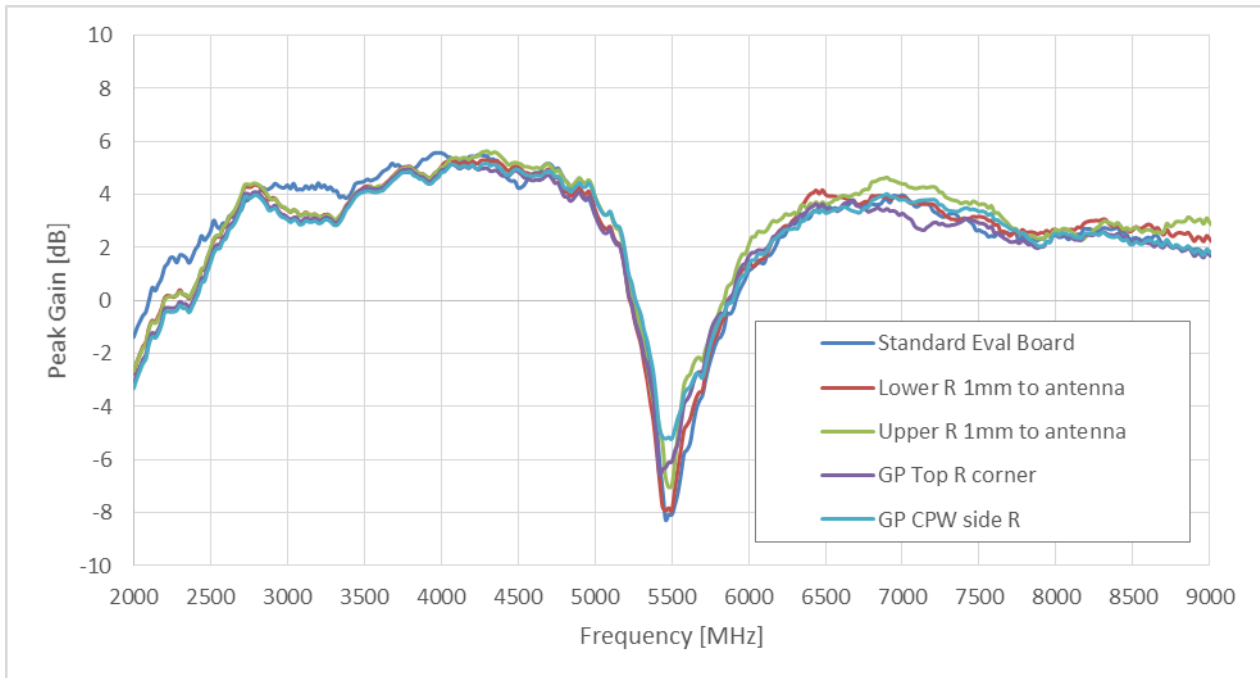
**Figure 11 Return loss for clearance study (metal component next to antenna)**



**Figure 12 Return loss for clearance study (metal component on the edge of ground plane)**



**Figure 13 Efficiency for clearance study**



**Figure 14 Peak gain for clearance study**



Taoglas makes no warranties based on the accuracy or completeness of the contents of this document and reserves the right to make changes to specifications and product descriptions at any time without notice.

Taoglas reserves the rights to this document and the information contained herein. Reproduction, use or disclosure to third parties without express permission is strictly prohibited.

Copyright © Taoglas Ltd.

# Mouser Electronics

Authorized Distributor

Click to View Pricing, Inventory, Delivery & Lifecycle Information:

[Taoglas:](#)

[UWC.20](#)