

# TEST REPORT

Applicant Name: VTech Telecommunications Ltd  
Address: 23/F Tai Ping Ind Center Block 1 57 Ting Kok Rd Tai Po NT, Hong Kong  
Report Number: SZ1240103-00576E-SAA  
FCC ID: EW780-H2B9-44

## Test Standard (s)

FCC 47 CFR part 2.1093

## Sample Description

Product Type: SIP cordless hotel phone  
Model No.: PMX-S5410  
Multiple Model(s) No.: PMX-S5410 HC, PMX-S5410 HC-S, PMX-S5420, PMX-S5420 HC, PMX-S5420 HC-S  
Trade Mark: vtech  
Serial Number: 2G4S-12  
Date Received: 2024/01/04  
Date of Test: 2024/03/26  
Issue Date: 2024/04/18

Test Result:	Pass▲
--------------	-------

▲ In the configuration tested, the EUT complied with the standards above.

## Prepared and Checked By:

*Sid Luo*

Sid Luo  
SAR Engineer

## Approved By:

*Luke Jiang*

Luke Jiang  
SAR Engineer

Note: The information marked<sup>#</sup>is provided by the applicant, the laboratory is not responsible for its authenticity and this information can affect the validity of the result in the test report. Customer model name, addresses, names, trademarks etc. are included.

This report cannot be reproduced except in full, without prior written approval of the Company. Unless otherwise stated the results shown in this test report refer only to the sample(s) tested. This report is valid only with a valid digital signature. The digital signature may be available only under the Adobe software above version 7.0.

This report must not be used by the customer to claim product certification, approval, or endorsement by NVLAP or any agency of the U.S. Government.

This report may contain data that are not covered by the NVLAP accreditation and are marked with an asterisk "▼" .

## Bay Area Compliance Laboratories Corp. (Shenzhen)

5F(B-West) , 6F, 7F, the 3rd Phase of Wan Li Industrial Building D, Shihua Rd, FuTian Free Trade Zone, Shenzhen, China

Tel: +86-755-33320018 Fax: +86-755-33320008 www.baclcorp.com.cn

<b>Attestation of Test Results</b>			
<b>MODE</b>		<b>Max. SAR Level(s) Reported(W/kg)</b>	<b>Limit (W/kg)</b>
<b>DECT</b>	1g Head SAR	<b>0.07</b>	<b>1.6</b>
	1g BodySAR	<b>0.07</b>	
<b>Applicable Standards</b>	<b>FCC 47 CFR part 2.1093</b> Radiofrequency radiation exposure evaluation: portable devices		
	<b>RF Exposure Procedures: TCB Workshop April 2019</b>		
	<b>IEEE1528:2013</b> IEEE Recommended Practice for Determining the Peak Spatial-Average Specific Absorption Rate (SAR) in the Human Head from Wireless Communications Devices: Measurement Techniques		
	<b>KDB procedures</b> KDB 447498 D01 General RF Exposure Guidance v06 KDB 648474 D04 Handset SAR v01r03 KDB 865664 D01 SAR Measurement 100 MHz to 6 GHz v01r04 KDB 865664 D02 RF Exposure Reporting v01r02		
<p><b>Note:</b> This wireless device has been shown to be capable of compliance for localized specific absorption rate (SAR) for General Population/Uncontrolled Exposure limits specified in <b>FCC 47 CFR part 2.1093</b> and has been tested in accordance with the measurement procedures specified in IEEE 1528-2013 and RF exposure KDB procedures.</p> <p><b>The results and statements contained in this report pertain only to the device(s) evaluated.</b></p>			

## TABLE OF CONTENTS

<b>DOCUMENT REVISION HISTORY</b> .....	<b>4</b>
<b>EUT DESCRIPTION</b> .....	<b>5</b>
TECHNICAL SPECIFICATION.....	5
<b>REFERENCE, STANDARDS, AND GUIDELINES</b> .....	<b>6</b>
SAR LIMITS .....	6
<b>FACILITIES</b> .....	<b>7</b>
<b>DESCRIPTION OF TEST SYSTEM</b> .....	<b>8</b>
<b>EQUIPMENT LIST AND CALIBRATION</b> .....	<b>15</b>
EQUIPMENT’S LIST & CALIBRATION INFORMATION.....	15
<b>SAR MEASUREMENT SYSTEM VERIFICATION</b> .....	<b>16</b>
LIQUID VERIFICATION.....	16
SYSTEM ACCURACY VERIFICATION .....	17
SAR SYSTEM VALIDATION DATA .....	18
<b>EUT TEST STRATEGY AND METHODOLOGY</b> .....	<b>19</b>
TEST POSITIONS FOR DEVICE OPERATING NEXT TO A PERSON’S EAR.....	19
CHEEK/TOUCH POSITION .....	20
EAR/TILT POSITION.....	20
TEST POSITIONS FOR BODY-WORN AND OTHER CONFIGURATIONS .....	21
TEST DISTANCE FOR SAR EVALUATION .....	21
SAR EVALUATION PROCEDURE .....	22
<b>CONDUCTED OUTPUT POWER MEASUREMENT</b> .....	<b>23</b>
TEST PROCEDURE.....	23
MAXIMUM TARGET OUTPUT POWER.....	23
TEST RESULTS:.....	24
<b>STANDALONE SAR TEST EXCLUSION CONSIDERATIONS</b> .....	<b>25</b>
ANTENNAS LOCATION: .....	25
STANDALONE SAR TEST EXCLUSION CONSIDERATIONS .....	25
<b>SAR MEASUREMENT RESULTS</b> .....	<b>26</b>
TEST RESULTS:.....	26
<b>SAR MEASUREMENT VARIABILITY</b> .....	<b>27</b>
<b>SAR PLOTS</b> .....	<b>28</b>
<b>APPENDIX A MEASUREMENT UNCERTAINTY</b> .....	<b>38</b>
<b>APPENDIX B EUT TEST POSITION PHOTOS</b> .....	<b>39</b>
LIQUID DEPTH ≥ 15CM.....	39
HEAD LEFT CHEEKSETUP PHOTO (0 MM).....	40
HEAD LEFT TILTSETUP PHOTO (0 MM).....	40
HEAD RIGHT CHEEKSETUP PHOTO (0 MM).....	41
HEAD RIGHT TILTSETUP PHOTO (0 MM) .....	41
BODY FRONTSETUP PHOTO (0 MM).....	42
BODY BACKSETUP PHOTO (0 MM) .....	42
<b>APPENDIX C PROBE CALIBRATION CERTIFICATES</b> .....	<b>43</b>
<b>APPENDIX D DIPOLE CALIBRATION CERTIFICATES</b> .....	<b>52</b>
<b>APPENDIX E RETURN LOSS&amp;IMPEDANCE MEASUREMENT</b> .....	<b>58</b>

**DOCUMENT REVISION HISTORY**

<b>Revision Number</b>	<b>Report Number</b>	<b>Description of Revision</b>	<b>Date of Revision</b>
0	SZ1240103-00576E-SAA	Original Report	2024/04/18

## EUT DESCRIPTION

This report has been prepared on behalf of **VTech Telecommunications Ltd** and their product **SIP cordless hotel phone**, Test Model: **PMX-S5410**, FCC ID: **EW780-H2B9-44** or the EUT (Equipment under Test) as referred to in the rest of this report.

*\*All measurement and test data in this report was gathered from production sample serial number:2G4S-12(Assigned by BACL, Shenzhen).The EUT supplied by the applicant was received on 2024-01-04.*

### Technical Specification

<b>Product Type:</b>	Portable
<b>Exposure Category:</b>	Population / Uncontrolled
<b>Antenna Type(s):</b>	Internal Antenna
<b>Body-Worn Accessories:</b>	None
<b>Operation modes:</b>	DECT
<b>Frequency Band:</b>	DECT:1921.536-1928.448 MHz;
<b>Modulation Technique:</b>	GFSK
<b>Conducted RF Power:</b>	DECT: 19.94 dBm
<b>Power Source:</b>	DC 3.7V from battery
<b>Normal Operation:</b>	Headand Body
Note: The Multiple models are electrically identical with the test model except for model name, base and charger. Please refer to the declaration letter <sup>#</sup> for more detail, which was provided by manufacturer.	

## REFERENCE, STANDARDS, AND GUIDELINES

### FCC:

The Report and Order requires routine SAR evaluation prior to equipment authorization of portable transmitter devices, including portable telephones. For consumer products, the applicable limit is 1.6 mW/g as recommended by the ANSI/IEEE standard C95.1-1992 [6] for an uncontrolled environment (Paragraph 65). According to the Supplement C of OET Bulletin 65 "Evaluating Compliance with FCC Guide-lines for Human Exposure to Radio frequency Electromagnetic Fields", released on Jun 29, 2001 by the FCC, the device should be evaluated at maximum output power (radiated from the antenna) under "worst-case" conditions for normal or intended use, incorporating normal antenna operating positions, device peak performance frequencies and positions for maximum RF energy coupling.

This report describes the methodology and results of experiments performed on wireless data terminal. The objective was to determine if there is RF radiation and if radiation is found, what is the extent of radiation with respect to safety limits. SAR (Specific Absorption Rate) is the measure of RF exposure determined by the amount of RF energy absorbed by human body (or its parts) – to determine how the RF energy couples to the body or head which is a primary health concern for body worn devices. The limit below which the exposure to RF is considered safe by regulatory bodies in North America is 1.6 mW/g average over 1 gram of tissue mass.

### SAR Limits

#### FCC Limit(1g Tissue)

EXPOSURE LIMITS	SAR (W/kg)	
	(General Population / Uncontrolled Exposure Environment)	(Occupational / Controlled Exposure Environment)
Spatial Average (averaged over the whole body)	0.08	0.4
Spatial Peak (averaged over any 1 g of tissue)	<b>1.6</b>	8.0
Spatial Peak (hands/wrists/feet/ankles averaged over 10 g)	4.0	20.0

Population/Uncontrolled Environments are defined as locations where there is the exposure of individual who have no knowledge or control of their exposure.

Occupational/Controlled Environments are defined as locations where there is exposure that maybe incurred by people who are aware of the potential for exposure (i.e. as a result of employment or occupation).

General Population/Uncontrolled environments Spatial Peak limit 1.6W/kg for 1g SAR applied to the EUT.

## **FACILITIES**

---

The test site used by Bay Area Compliance Laboratories Corp. (Shenzhen) to collect data is located at 5F(B-West) ,6F,7F,the 3rd Phase of Wan Li Industrial Building D,Shihua Rd, FuTian Free Trade Zone, Shenzhen, China

The lab has been recognized as the FCC accredited lab under the KDB 974614 D01 and is listed in the FCC Public Access Link (PAL) database, FCC Registration No.: 715558, the FCC Designation No.: CN5045.

Each test item follows test standards and with no deviation.

## DESCRIPTION OF TEST SYSTEM

These measurements were performed with the automated near-field scanning system DASY6 from Schmid & Partner Engineering AG (SPEAG) which is the Fifth generation of the system shown in the figure hereinafter:

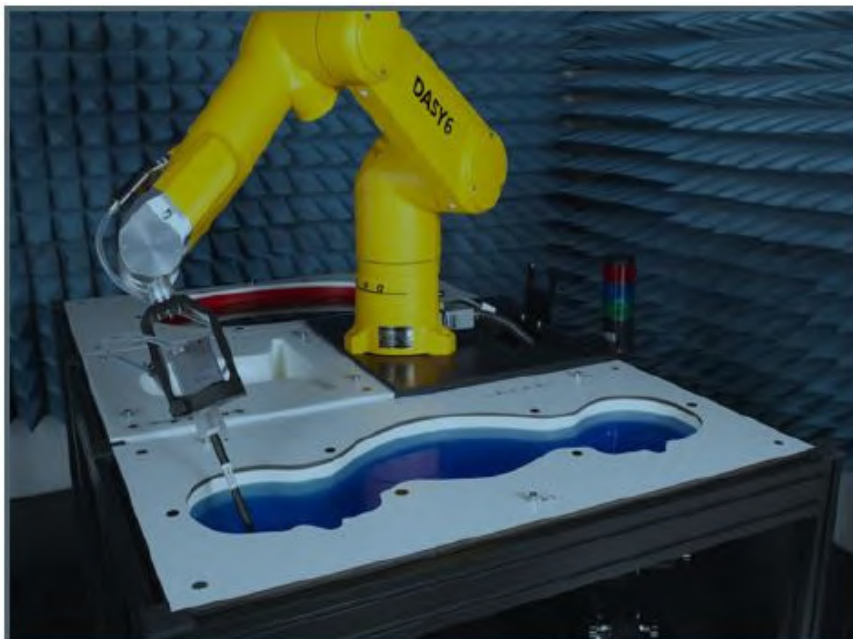

### DASY6 System Description

The DASY6 system for performing compliance tests consists of the following items:

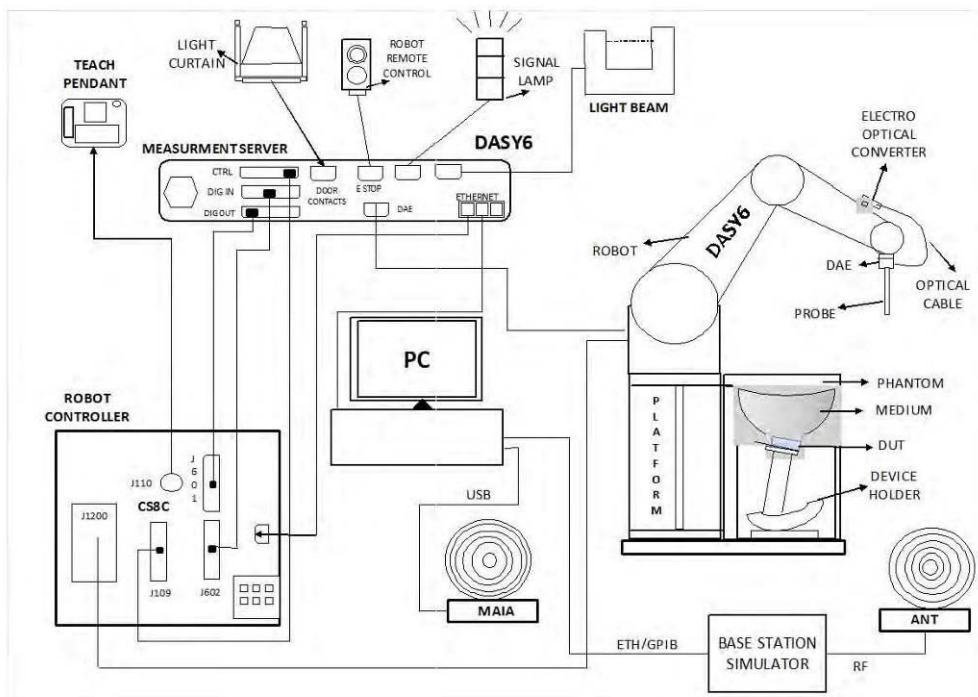



- A standard high precision 6-axis robot (Staubli TX=RX family) with controller, teach pendant and software. An arm extension for accommodating the data acquisition electronics (DAE).
- An isotropic field probe optimized and calibrated for the targeted measurement.
- A data acquisition electronics (DAE) which performs the signal application, signal multiplexing, AD-conversion, offset measurements, mechanical surface detection, collision detection, etc. The unit is battery powered with standard or rechargeable batteries. The signal is optically transmitted to the EOC.
- The Electro-optical converter (EOC) performs the conversion from optical to electrical signals for the digital communication to the DAE. To use optical surface detection, a special version of the EOC is required. The EOC signal is transmitted to the measurement server.
- The function of the measurement server is to perform the time critical tasks such as signal filtering, control of the robot operation and fast movement interrupts.
- The Light Beam used is for probe alignment. This improves the (absolute) accuracy of the probe positioning.
- A computer running Win7 professional operating system and the DASY52 software.
- Remote control and teach pendant as well as additional circuitry for robot safety such as warning lamps, etc.
- The phantom, the device holder and other accessories according to the targeted measurement.

### DASY6 Measurement Server

The DASY6 measurement server is based on a PC/104 CPU board with a 400 MHz Intel ULV Celeron, 128 MB chip-disk and 128 MB RAM. The necessary circuits for communication with the DAE4 (or DAE3) electronics box, as well as the 16-bit AD converter system for optical detection and digital I/O interface are contained on the DASY6 I/O board, which is directly connected to the PC/104 bus of the CPU board.



The measurement server performs all real-time data evaluations of field measurements and surface detection, controls robot movements, and handles safety operations. The PC operating system cannot interfere with these time-critical processes. All connections are supervised by a watchdog, and disconnection of any of the cables to the measurement server will automatically disarm the robot and disable all program- controlled robot movements. Furthermore, the measurement server is equipped with an expansion port, which is reserved for future applications. Please note that this expansion port does not have a standardized pinout, and therefore only devices provided by SPEAG can be connected. Connection of devices from any other supplier could seriously damage the measurement server.

### Data Acquisition Electronics

The data acquisition electronics (DAE4) consist of a highly sensitive electrometer-grade preamplifier with auto-zeroing, a channel and gain-switching multiplexer, a fast 16 bit AD-converter and a command decoder with a control logic unit. Transmission to the measurement server is accomplished through an optical downlink for data and status information, as well as an optical uplink for commands and the clock.

The mechanical probe mounting device includes two different sensor systems for frontal and sideways probe contacts. They are used for mechanical surface detection and probe collision detection.

The input impedance of both the DAE4 as well as of the DAE3 box is 200M $\Omega$ ; the inputs are symmetrical and floating. Common mode rejection is above 80 dB.

**EX3DV4 E-Field Probes**

<b>Frequency</b>	4 MHz to >10 GHz Linearity: ± 0.2 dB (30 MHz to 10 GHz)
<b>Directivity</b>	± 0.1 dB in TSL (rotation around probe axis) ± 0.3 dB in TSL (rotation normal to probe axis)
<b>Dynamic Range</b>	10 µW/g to > 100 mW/g Linearity: ± 0.2 dB (noise: typically < 1 µW/g)
<b>Dimensions</b>	Overall length: 337 mm (Tip: 20 mm) Tip diameter: 2.5 mm (Body: 12 mm) Typical distance from probe tip to dipole centers: 1 mm
<b>Application</b>	High precision dosimetric measurements in any exposure scenario (e.g., very strong gradient fields); the only probe that enables compliance testing for frequencies up to 6 GHz with precision of better 30%.
<b>Compatibility</b>	DASY3, DASY4, DASY52 SAR and higher, EASY6, EASY4/MRI

**SAM Twin Phantom**

The SAM Twin Phantom (shown in front of DASY6) is a fiberglass shell phantom with shell thickness 2 mm, except in the ear region where the thickness is increased to 6 mm. The phantom has three measurement areas: 1) Left Head, 2) Right Head, and 3) Flat Section. For larger devices, the use of the ELI-Phantom (shown behind DASY6) is required. For devices such as glasses with a wireless link, the Face Down Phantom is the most suitable (between the SAM Twin and ELI phantoms).

When the phantom is mounted inside allocated slot of the DASY6 platform, phantom reference points can be taught directly in the DASY5 V5.2 software. When the DASY6 platform is used to mount the

Phantom, some of the phantom teaching points cannot be reached by the robot in DASY5 V5.2. A special tool called P1a-P2aX-Former is provided to transform two of the three points, P1 and P2, to reachable locations. To use these new teaching points, a revised phantom configuration file is required.

In addition to our standard broadband liquids, the phantom can be used with the following tissue simulating liquids:

Sugar-water-based liquids can be left permanently in the phantom. Always cover the liquid when the system is not in use to prevent changes in liquid parameters due to water evaporation.

DGBE-based liquids should be used with care. As DGBE is a softener for most plastics, the liquid should be taken out of the phantom, and the phantom should be dried when the system is not in use (desirable at least once a week).

Do not use other organic solvents without previously testing the solvent resistivity of the phantom. Approximately 25 liters of liquid is required to fill the SAM Twin phantom.

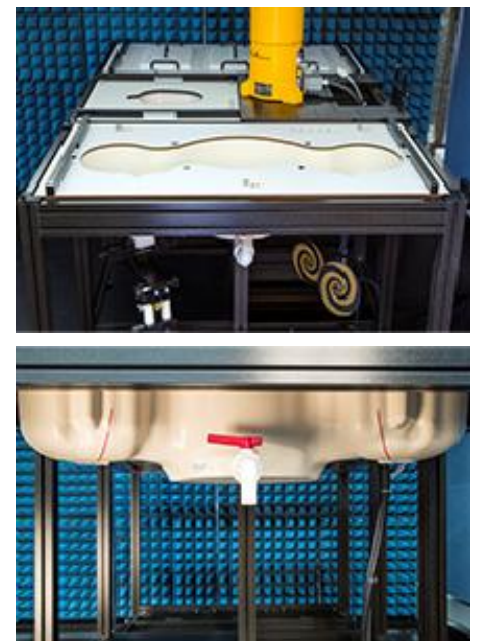

## ELI Phantom

The ELI phantom is intended for compliance testing of handheld and body-mounted wireless devices in the frequency range of 30MHz to 6 GHz. ELI is fully compatible with the latest draft of the standard IEEE1528:2013 and the use of all known tissue simulating liquids. ELI has been optimized for performance and can be integrated into a SPEAG standard phantom table. A cover is provided to prevent evaporation of water and changes in liquid parameters. Reference markings on the phantom allow installation of the complete setup, including all predefined phantom positions and measurement grids, by teaching three points.

The phantom can be used with the following tissue simulating liquids:

- Sugar-water-based liquids can be left permanently in the phantom. Always cover the liquid when the system is not in use to prevent changes in liquid parameters due to water evaporation.
- DGBE-based liquids should be used with care. As DGBE is a softener for most plastics, the liquid should be taken out of the phantom, and the phantom should be dried when the system is not in use (desirable at least once a week).
- Do not use other organic solvents without previously testing the solvent resistivity of the phantom.

Approximately 25 liters of liquid is required to fill the ELI phantom.

## Robots

The DASY6 system uses the high-precision industrial robots TX60L, TX90XL, and RX160L from Staubli SA (France). The TX robot family - the successor of the well-known RX robot family - continues to offer the features important for DASY6 applications:

- High precision (repeatability 0.02mm)
- High reliability (industrial design)
- Low maintenance costs (virtually maintenance free due to direct drive gears; no belt drives)
- Jerk-free straight movements (brushless synchrony motors; no stepper motors)
- Low ELF interference (motor control fields shielded via the closed metallic construction shields)

The robots are controlled by the Staubli CS8c robot controllers. All information regarding the use and maintenance of the robot arm and the robot controller is provided.

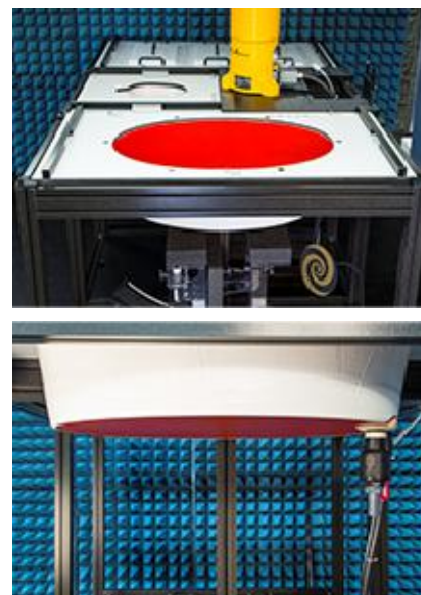

**Calibration Frequency Points for EX3DV4 E-Field Probes SN: 7382 Calibrated: 2023/09/27**

Calibration Frequency Point(MHz)	Frequency Range(MHz)		Conversion Factor		
	From	To	X	Y	Z
750 Head	650	850	10.65	10.65	10.65
900 Head	850	1000	10.19	10.19	10.19
1750 Head	1650	1850	8.60	8.60	8.60
1900 Head	1850	2000	8.30	8.30	8.30
2300 Head	2200	2400	8.16	8.16	8.16
2450 Head	2400	2550	7.89	7.89	7.89
2600 Head	2550	2700	7.65	7.65	7.65
3300 Head	3200	3400	7.39	7.39	7.39
3500 Head	3400	3600	7.24	7.24	7.24
3700 Head	3600	3800	7.10	7.10	7.10
3900 Head	3800	4000	6.98	6.98	6.98
5250 Head	5140	5360	5.62	5.62	5.62
5500 Head	5390	5610	5.10	5.10	5.10
5750 Head	5640	5860	5.08	5.08	5.08

**SAR Scan Procedures**

**Step 1: Power Reference Measurement**

The Power Reference Measurement and Power Drift Measurements are for monitoring the power drift of the device under test in the batch process. The minimum distance of probe sensors to surface determines the closest measurement point to phantom surface. The minimum distance of probe sensors to surface is 1.4 mm. This distance cannot be smaller than the distance of sensor calibration points to probe tip as defined in the probe properties.

**Step 2: Area Scans**

Area scans are defined prior to the measurement process being executed with a user defined variable spacing between each measurement point (integral) allowing low uncertainty measurements to be conducted. Scans defined for FCC applications utilize a 15mm<sup>2</sup> step integral, with 1.5mm interpolation used to locate the peak SAR area used for zoom scan assessments.

Where the system identifies multiple SAR peaks (which are within 25% of peak value) the system will provide the user with the option of assessing each peak location individually for zoom scan averaging.

Area Scan Parameters extracted from KDB 865664 D01 SAR Measurement 100 MHz to 6 GHz

	≤ 3 GHz	> 3 GHz
Maximum distance from closest measurement point (geometric center of probe sensors) to phantom surface	5 mm ± 1 mm	½ · δ · ln(2) mm ± 0.5 mm
Maximum probe angle from probe axis to phantom surface normal at the measurement location	30° ± 1°	20° ± 1°
Maximum area scan spatial resolution: Δx <sub>Area</sub> , Δy <sub>Area</sub>	≤ 2 GHz: ≤ 15 mm 2 – 3 GHz: ≤ 12 mm	3 – 4 GHz: ≤ 12 mm 4 – 6 GHz: ≤ 10 mm
	When the x or y dimension of the test device, in the measurement plane orientation, is smaller than the above, the measurement resolution must be ≤ the corresponding x or y dimension of the test device with at least one measurement point on the test device.	

### Step 3: Zoom Scan (Cube Scan Averaging)

The averaging zoom scan volume utilized in the DASY5 software is in the shape of a cube and the side dimension of a 1 g or 10 g mass is dependent on the density of the liquid representing the simulated tissue. A density of 1000 kg/m<sup>3</sup> is used to represent the head and body tissue density and not the phantom liquid density, in order to be consistent with the definition of the liquid dielectric properties, i.e. the side length of the 1g cube is 5mm, with the side length of the 10g cube is 21.5mm.

Zoom Scan Parameters extracted from KDB 865664 D01 SAR Measurement 100 MHz to 6 GHz

Maximum zoom scan spatial resolution: $\Delta x_{Zoom}, \Delta y_{Zoom}$		$\leq 2$ GHz: $\leq 8$ mm 2 – 3 GHz: $\leq 5$ mm*	3 – 4 GHz: $\leq 5$ mm* 4 – 6 GHz: $\leq 4$ mm*
Maximum zoom scan spatial resolution, normal to phantom surface	uniform grid: $\Delta z_{Zoom}(n)$	$\leq 5$ mm	3 – 4 GHz: $\leq 4$ mm 4 – 5 GHz: $\leq 3$ mm 5 – 6 GHz: $\leq 2$ mm
	graded grid	$\Delta z_{Zoom}(1)$ : between 1 <sup>st</sup> two points closest to phantom surface	$\leq 4$ mm
		$\Delta z_{Zoom}(n>1)$ : between subsequent points	$\leq 1.5 \cdot \Delta z_{Zoom}(n-1)$ mm
Minimum zoom scan volume	x, y, z	$\geq 30$ mm	3 – 4 GHz: $\geq 28$ mm 4 – 5 GHz: $\geq 25$ mm 5 – 6 GHz: $\geq 22$ mm
<p>Note: <math>\delta</math> is the penetration depth of a plane-wave at normal incidence to the tissue medium; see IEEE Std 1528-2013 for details.</p> <p>* When zoom scan is required and the <i>reported</i> SAR from the <i>area scan based 1-g SAR estimation</i> procedures of KDB Publication 447498 is <math>\leq 1.4</math> W/kg, <math>\leq 8</math> mm, <math>\leq 7</math> mm and <math>\leq 5</math> mm zoom scan resolution may be applied, respectively, for 2 GHz to 3 GHz, 3 GHz to 4 GHz and 4 GHz to 6 GHz.</p>			

### Step 4: Power Drift Measurement

The Power Drift Measurement measures the field at the same location as the most recent power reference measurement within the same procedure, and with the same settings. The Power Drift Measurement gives the field difference in dB from the reading conducted within the last Power Reference Measurement. This allows a user to monitor the power drift of the device under test within a batch process. The measurement procedure is the same as Step 1.

When the cube intersects with the surface of the phantom, it is oriented so that 3 vertices touch the surface of the shell or the center of a face is tangent to the surface. The face of the cube closest to the surface is modified in order to conform to the tangent surface.

The zoom scan integer steps can be user defined so as to reduce uncertainty, but normal practice for typical test applications (including FCC) utilize a physical step of 7 x 7 x 7 (5mmx5mmx5mm) providing a volume of 30 mm in the X & Y & Z axis.



## Tissue Dielectric Parameters for Head and Body Phantoms

The head tissue dielectric parameters recommended by the IEEE1528:2013

### Recommended Tissue Dielectric Parameters for Head liquid

**Table A.3 – Dielectric properties of the head tissue-equivalent liquid**

Frequency MHz	Relative permittivity $\epsilon_r$	Conductivity ( $\sigma$ ) S/m
300	45,3	0,87
450	43,5	0,87
<i>750</i>	<i>41,9</i>	<i>0,89</i>
835	41,5	0,90
900	41,5	0,97
1 450	40,5	1,20
<i>1 500</i>	<i>40,4</i>	<i>1,23</i>
<i>1 640</i>	<i>40,2</i>	<i>1,31</i>
<i>1 750</i>	<i>40,1</i>	<i>1,37</i>
1 800	40,0	1,40
1 900	40,0	1,40
2 000	40,0	1,40
<i>2 100</i>	<i>39,8</i>	<i>1,49</i>
<i>2 300</i>	<i>39,5</i>	<i>1,67</i>
2 450	39,2	1,80
<i>2 600</i>	<i>39,0</i>	<i>1,96</i>
3 000	38,5	2,40
<i>3 500</i>	<i>37,9</i>	<i>2,91</i>
<i>4 000</i>	<i>37,4</i>	<i>3,43</i>
<i>4 500</i>	<i>36,8</i>	<i>3,94</i>
<i>5 000</i>	<i>36,2</i>	<i>4,45</i>
<i>5 200</i>	<i>36,0</i>	<i>4,66</i>
<i>5 400</i>	<i>35,8</i>	<i>4,86</i>
<i>5 600</i>	<i>35,5</i>	<i>5,07</i>
<i>5 800</i>	<i>35,3</i>	<i>5,27</i>
<i>6 000</i>	<i>35,1</i>	<i>5,48</i>

NOTE For convenience, permittivity and conductivity values at those frequencies which are not part of the original data provided by Drossos et al. [33] or the extension to 5 800 MHz are provided (i.e. the values shown *in italics*). These values were linearly interpolated between the values in this table that are immediately above and below these values, except the values at 6 000 MHz that were linearly extrapolated from the values at 3 000 MHz and 5 800 MHz.

## EQUIPMENT LIST AND CALIBRATION

### Equipment's List & Calibration Information

Equipment	Model	S/N	Calibration Date	Calibration Due Date
DASY5 Test Software	DASY52 52.10.2	N/A	NCR	NCR
DASY6 Measurement Server	DASY6 6.0.31	N/A	NCR	NCR
Data Acquisition Electronics	DAE4	1325	2023/09/27	2024/09/26
E-Field Probe	EX3DV4	7382	2023/09/27	2024/09/26
Mounting Device	MD4HHTV5	SD 000 H01 KA	NCR	NCR
SAM Twin Phantom	SAM-Twin V8.0	1962	NCR	NCR
Dipole,1900MHz	D1900V2	5d231	2023/02/17	2026/02/16
Simulated Tissue Liquid Head	HBBL600-10000V6	180622-2	Each Time	/
Network Analyzer	E5071C	SER MY46519680	2023/06/08	2024/06/07
Dielectric Assessment Kit	DAK-3.5	1248	NCR	NCR
MXG Analog Signal Generator	N5181A	MY48180408	2024/01/16	2025/01/15
USB wideband power sensor	U2021XA	MY52350001	2023/06/08	2024/06/07
Directional Coupler	855673	3307	NCR	NCR
20dB Attenuator	2	BH9879	NCR	NCR
RF Power Amplifier	5205FE	1014	NCR	NCR
Digital Radio Communication Tester	CMD60	830553/018	2023/06/08	2024/06/07
Temperature & Humidity Meter	DTM3000	N/A	2024/01/16	2025/01/15

**NCR:**No Calibration Required.

# SAR MEASUREMENT SYSTEM VERIFICATION

## Liquid Verification

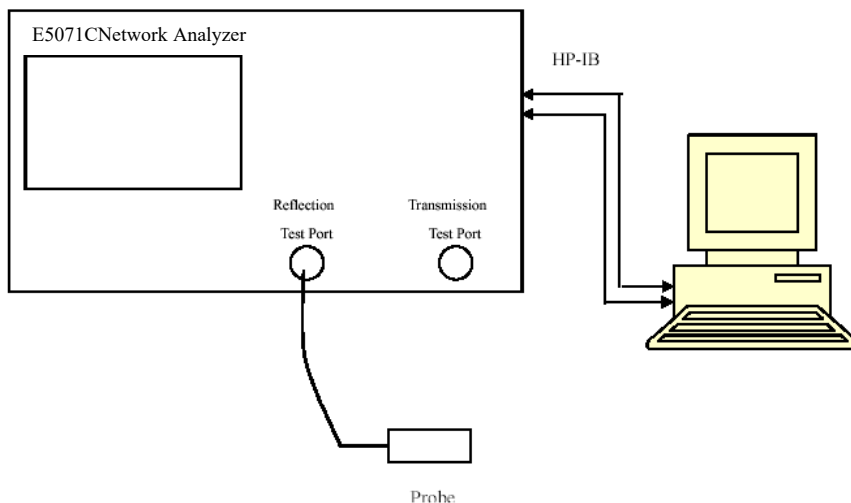

Liquid Verification Setup Block Diagram

## Liquid Verification Results

Frequency (MHz)	Liquid Type	Liquid Parameter		Target Value		Delta (%)		Tolerance (%)
		$\epsilon_r$	$\sigma$ (S/m)	$\epsilon_r$	$\sigma$ (S/m)	$\Delta\epsilon_r$	$\Delta\sigma$ (S/m)	
1900	Simulated Tissue Liquid Head	39.450	1.379	40.00	1.40	-1.37	-1.50	$\pm 5$
1921.54	Simulated Tissue Liquid Head	39.361	1.379	40.00	1.40	-1.60	-1.50	$\pm 5$
1924.99	Simulated Tissue Liquid Head	39.347	1.379	40.00	1.40	-1.63	-1.50	$\pm 5$
1928.45	Simulated Tissue Liquid Head	39.333	1.379	40.00	1.40	-1.67	-1.50	$\pm 5$

\*Liquid Verification above was performed on 2024/03/26.



### System Accuracy Verification

Prior to the assessment, the system validation kit was used to test whether the system was operating within its specifications of  $\pm 10\%$ . The validation results are tabulated below. And also the corresponding SAR plot is attached as well in the SAR plots files.

The spacing distances in the **System Verification Setup Block Diagram** is given by the following:

- a)  $s = 15 \text{ mm} \pm 0,2 \text{ mm}$  for  $300 \text{ MHz} \leq f \leq 1 \text{ 000 MHz}$ ;
- b)  $s = 10 \text{ mm} \pm 0,2 \text{ mm}$  for  $1 \text{ 000 MHz} < f \leq 3 \text{ 000 MHz}$ ;
- c)  $s = 10 \text{ mm} \pm 0,2 \text{ mm}$  for  $3 \text{ 000 MHz} < f \leq 6 \text{ 000 MHz}$ .

### System Verification Setup Block Diagram

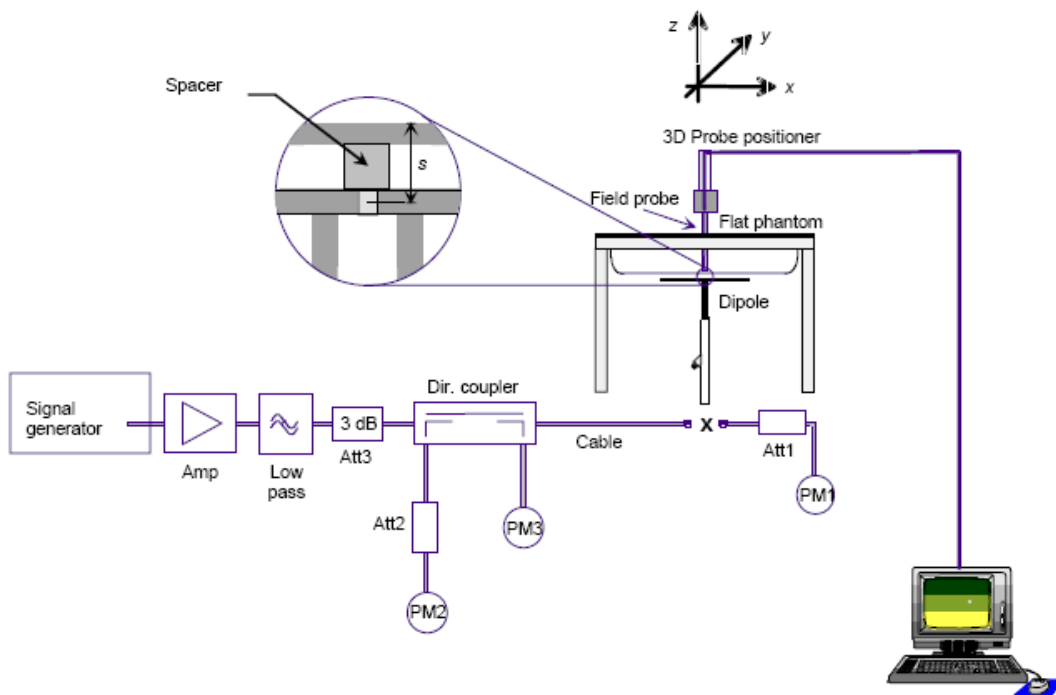

### System Accuracy Check Results

Date	Frequency Band (MHz)	Liquid Type	Input Power (mW)	Measured SAR (W/kg)	Normalized to 1W (W/kg)	Target Value (W/Kg)	Delta (%)	Tolerance (%)
2024/03/26	1900	Head	100	1g 3.73	37.3	39.9	-6.516	$\pm 10$

**Note:**  
All the SAR values are normalized to 1Watt forward power.

### SAR SYSTEM VALIDATION DATA

#### System Performance 1900 MHz Head

**DUT: Dipole 1900 MHz; Type: D1900V2; Serial: 5d231**

Communication System: UID 0, CW (0); Frequency: 1900 MHz; Duty Cycle: 1:1  
 Medium parameters used:  $f = 1900 \text{ MHz}$ ;  $\sigma = 1.379 \text{ S/m}$ ;  $\epsilon_r = 39.45$ ;  $\rho = 1000 \text{ kg/m}^3$   
 Phantom section: Flat Section

DASY5 Configuration:

- Probe: EX3DV4 - SN7382; ConvF(8.3, 8.3, 8.3) @ 1900 MHz;
- Sensor-Surface: 1.4mm (Mechanical Surface Detection)
- Electronics: DAE4 Sn1325; Calibrated: 9/27/2023
- Phantom: SAM-Twin V8.0 P1aP2a; Type: QD 000 P41 AA ; Serial: 1962
- Measurement SW: DASY52, Version 52.10 (2);

**Configuration/Head 1900MHz Pin=100mW/Area Scan (9x13x1):** Measurement grid: dx=10mm, dy=10mm  
 Maximum value of SAR (measured) = 5.85 W/kg

**Configuration/Head 1900MHz Pin=100mW/Zoom Scan (7x7x7)/Cube 0:** Measurement grid: dx=5mm, dy=5mm, dz=5mm

Reference Value = 57.00 V/m; Power Drift = -0.04 dB

Peak SAR (extrapolated) = 7.00 W/kg

**SAR(1 g) = 3.73 W/kg; SAR(10 g) = 1.92 W/kg**

Maximum value of SAR (measured) = 5.84 W/kg

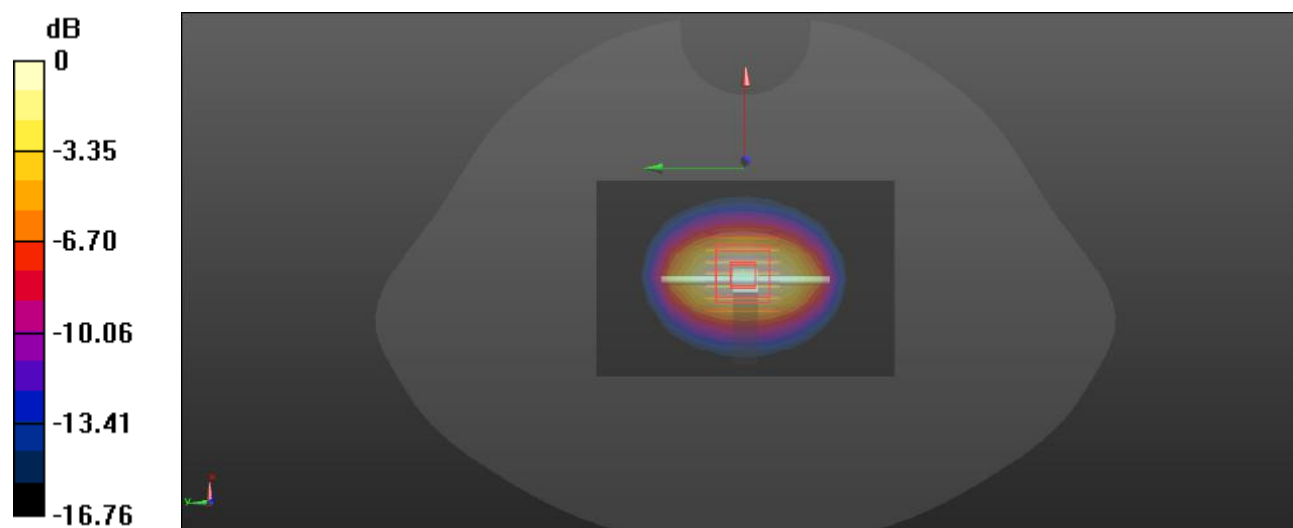

0 dB = 5.84 W/kg = 7.66 dBW/kg

## EUT TEST STRATEGY AND METHODOLOGY

### Test Positions for Device Operating Next to a Person’s Ear

This category includes most wireless handsets with fixed, retractable or Internal Antennas located toward the top half of the device, with or without a foldout, sliding or similar keypad cover. The handset should have its earpiece located within the upper ¼ of the device, either along the centerline or off-centered, as perceived by its users. This type of handset should be positioned in a normal operating position with the “test device reference point” located along the “vertical centerline” on the front of the device aligned to the “ear reference point”. The “test device reference point” should be located at the same level as the center of the earpiece region. The “vertical centerline” should bisect the front surface of the handset at its top and bottom edges. A “ear reference point” is located on the outer surface of the head phantom on each ear spacer. It is located 1.5 cm above the center of the ear canal entrance in the “phantom reference plane” defined by the three lines joining the center of each “ear reference point” (left and right) and the tip of the mouth.

A handset should be initially positioned with the earpiece region pressed against the ear spacer of a head phantom. For the SCC-34/SC-2 head phantom, the device should be positioned parallel to the “N-F” line defined along the base of the ear spacer that contains the “ear reference point”. For interim head phantoms, the device should be positioned parallel to the cheek for maximum RF energy coupling. The “test device reference point” is aligned to the “ear reference point” on the head phantom and the “vertical centerline” is aligned to the “phantom reference plane”. This is called the “initial ear position”. While maintaining these three alignments, the body of the handset is gradually adjusted to each of the following positions for evaluating SAR:

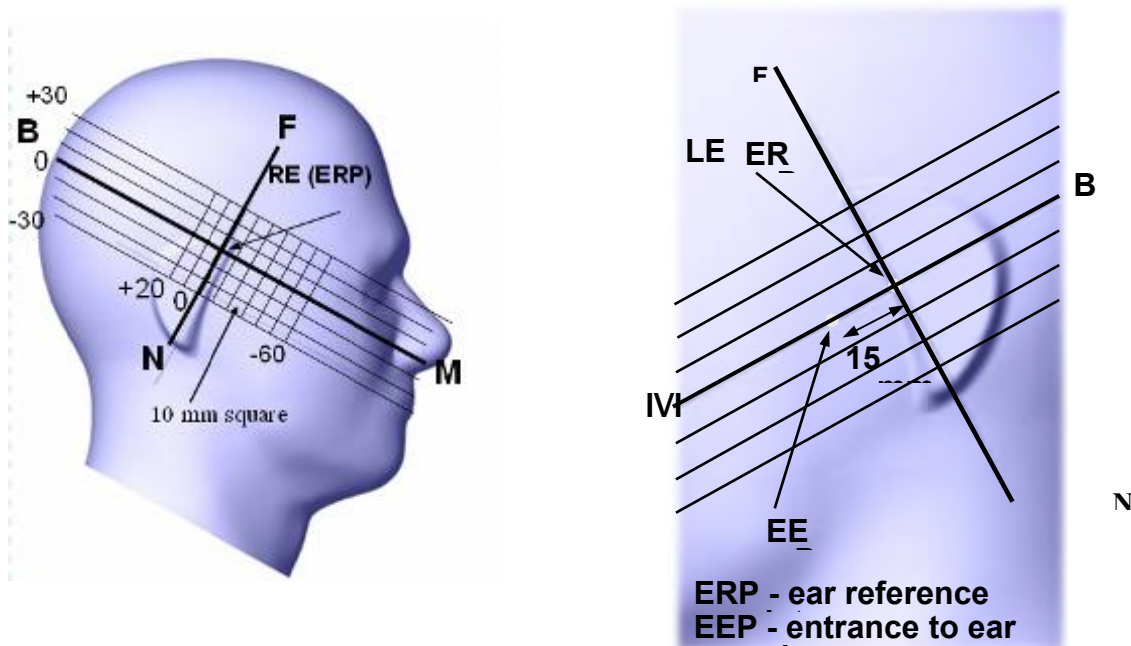

## Cheek/Touch Position

The device is brought toward the mouth of the head phantom by pivoting against the “ear reference point” or along the “N-F” line for the SCC-34/SC-2 head phantom.

This test position is established:

When any point on the display, keypad or mouthpiece portions of the handset is in contact with the phantom.

(or) When any portion of a foldout, sliding or similar keypad cover opened to its intended self-adjusting normal use position is in contact with the cheek or mouth of the phantom.

For existing head phantoms – when the handset loses contact with the phantom at the pivoting point, rotation should continue until the device touches the cheek of the phantom or breaks its last contact from the ear spacer.

### Cheek /Touch Position

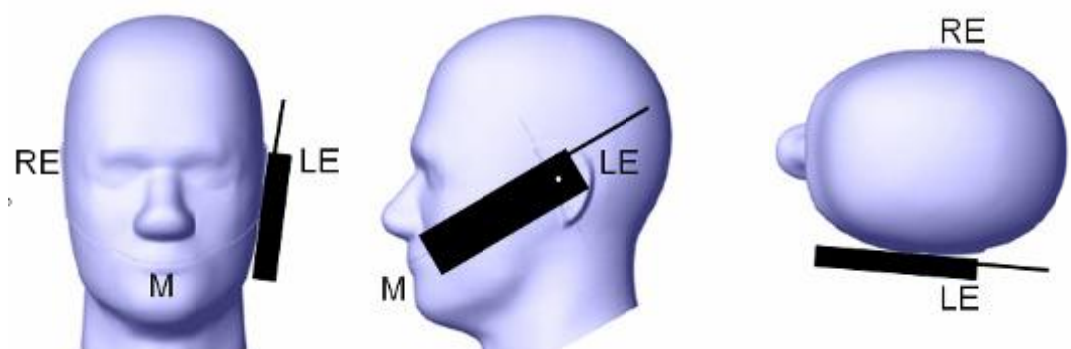

## Ear/Tilt Position

With the handset aligned in the “Cheek/Touch Position”:

1) If the earpiece of the handset is not in full contact with the phantom’s ear spacer (in the “Cheek/Touch position”) and the peak SAR location for the “Cheek/Touch” position is located at the ear spacer region or corresponds to the earpiece region of the handset, the device should be returned to the “initial ear position” by rotating it away from the mouth until the earpiece is in full contact with the ear spacer.

2) (otherwise) The handset should be moved (translated) away from the cheek perpendicular to the line passes through both “ear reference points” (note: one of these ear reference points may not physically exist on a split head model) for approximate 2-3 cm. While it is in this position, the device handset is tilted away from the mouth with respect to the “test device reference point” until the inside angle between the vertical centerline on the front surface of the phone and the horizontal line passing through the ear reference point is by 15 to 80°. After the tilt, it is then moved (translated) back toward the head perpendicular to the line passes through both “ear reference points” until the device touches the phantom or the ear spacer. If the antenna touches the head first, the positioning process should be repeated with a tilt angle less than 15° so that the device and its antenna would touch the phantom simultaneously. This test position may require a device holder or positioner to achieve the translation and tilting with acceptable positioning repeatability.

If a device is also designed to transmit with its keypad cover closed for operating in the head position, such positions should also be considered in the SAR evaluation. The device should be tested on the left and right side of the head phantom in the “Cheek/Touch” and “Ear/Tilt” positions. When applicable, each configuration should be tested with the antenna in its fully extended and fully retracted positions. These test configurations should be tested at the high, middle and low frequency channels of each operating mode; for example, AMPS, CDMA, and TDMA. If the SAR measured at the middle channel for each test configuration (left, right, Cheek/Touch, Tilt/Ear, extended and retracted) is at least 2.0 dB lower than the SAR limit, testing at the high and low channels is optional for such test configuration(s). If the transmission band of the test device is less than 10 MHz, testing at the high and low frequency channels is optional.

**Ear /Tilt 15° Position**

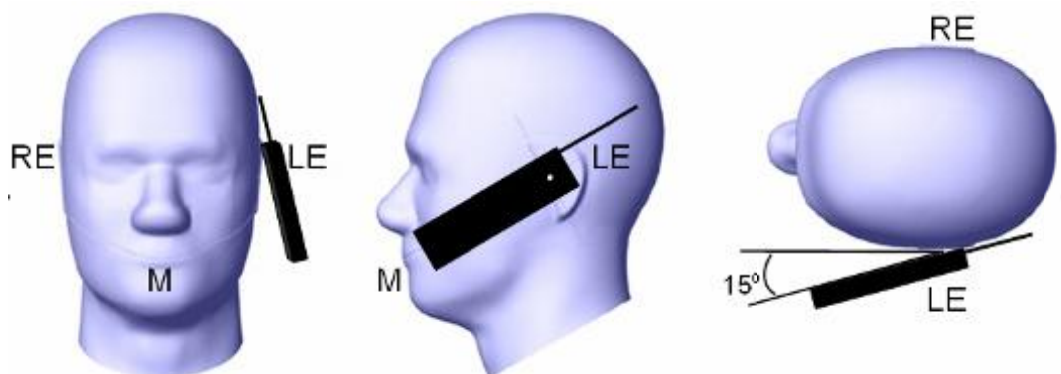

**Test positions for body-worn and other configurations**

Body-worn operating configurations should be tested with the belt-clips and holsters attached to the device and positioned against a flat phantom in normal use configurations. Devices with a headset output should be tested with a headset connected to the device. When multiple accessories that do not contain metallic components are supplied with the device, the device may be tested with only the accessory that dictates the closest spacing to the body. When multiple accessories that contain metallic components are supplied with the device, the device must be tested with each accessory that contains a unique metallic component. If multiple accessories share an identical metallic component (e.g., the same metallic belt-clip used with different holsters with no other metallic components), only the accessory that dictates the closest spacing to the body must be tested.

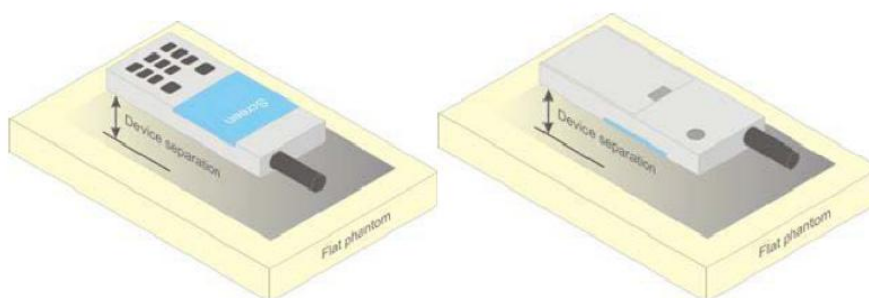

**Figure 5 – Test positions for body-worn devices**

**Test Distance for SAR Evaluation**

In this case the EUT (Equipment Under Test) is set directly against the phantom, the test distance is 0 mm.

## SAR Evaluation Procedure

The evaluation was performed with the following procedure:

- Step 1: Measurement of the SAR value at a fixed location above the ear point or central position was used as a reference value for assessing the power drop. The SAR at this point is measured at the start of the test and then again at the end of the testing.
- Step 2: The SAR distribution at the exposed side of the head was measured at a distance of 4 mm from the inner surface of the shell. The area covered the entire dimension of the head or radiating structures of the EUT, the horizontal grid spacing was 15 mm x 15 mm, and the SAR distribution was determined by integrated grid of 1.5mm x 1.5mm. Based on these data, the area of the maximum absorption was determined by spline interpolation. The first Area Scan covers the entire dimension of the EUT to ensure that the hotspot was correctly identified.
- Step 3: Around this point, a volume of 30 mm x 30 mm x 30 mm was assessed by measuring 7x 7 x 7 points. On the basis of this data set, the spatial peak SAR value was evaluated under the following procedure:
- 1) The data at the surface were extrapolated, since the center of the dipoles is 1.2 mm away from the tip of the probe and the distance between the surface and the lowest measuring point is 1.3 mm. The extrapolation was based on a least square algorithm. A polynomial of the fourth order was calculated through the points in z-axes. This polynomial was then used to evaluate the points between the surface and the probe tip.
  - 2) The maximum interpolated value was searched with a straightforward algorithm. Around this maximum the SAR values averaged over the spatial volumes (1 g or 10 g) were computed by the 3D-Spline interpolation algorithm. The 3D-Spline is composed of three one dimensional splines with the "Not a knot"-condition (in x, y and z-directions). The volume was integrated with the trapezoidal-algorithm. One thousand points (10 x 10 x 10) were interpolated to calculate the averages.
- All neighboring volumes were evaluated until no neighboring volume with a higher average value was found.
- Step 4: Re-measurement of the SAR value at the same location as in Step 1. If the value changed by more than 5%, the evaluation was repeated.

## CONDUCTED OUTPUT POWER MEASUREMENT

### Test Procedure

The RF output of the transmitter was connected to the input of the Digital Radio Communication Tester.

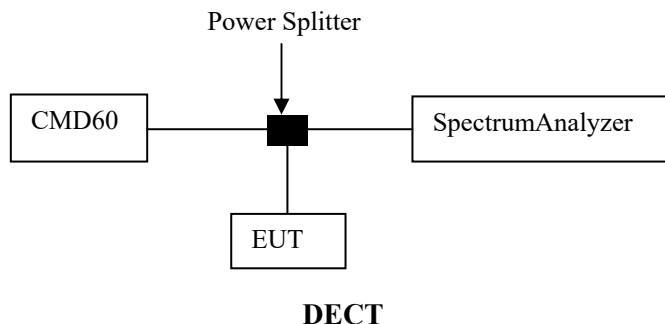

### Maximum Target Output Power

Max Target Power(dBm)			
Mode/Band	Channel		
	Low	Middle	High
DECT	20.2	20.2	20.2

**Test Results:**

**DECT:**

Mode	Frequency (MHz)	RF Output Peak Power (dBm)
DECT	1921.536	19.94
	1924.992	19.77
	1928.448	19.75

**Note:**

1. Rohde & Schwarz Radio Communication Tester (CMD60) was used for the measurement of DECT peak output power.
2. The DECT output peak power is from Radio report.
3. Duty Cycle=1:25.2 (0.0397).
4. The EUT belongs to a low duty cycle device.
5. Per IEEE1528:2013, **1 Channel** shall be tested; the middle channel was selected to test:

$$N_c = Round \left\{ \left[ 100(f_{high} - f_{low}) / f_c \right]^{0.5} \times (f_c / 100)^{0.2} \right\},$$

where  $f_{high}$  is the highest frequency in the band and  $f_{low}$  is the lowest  $f_c$  is the center frequency in the band. At the same time, we chose the worst mode to carry out additional testing on other channels.

DutyCycle

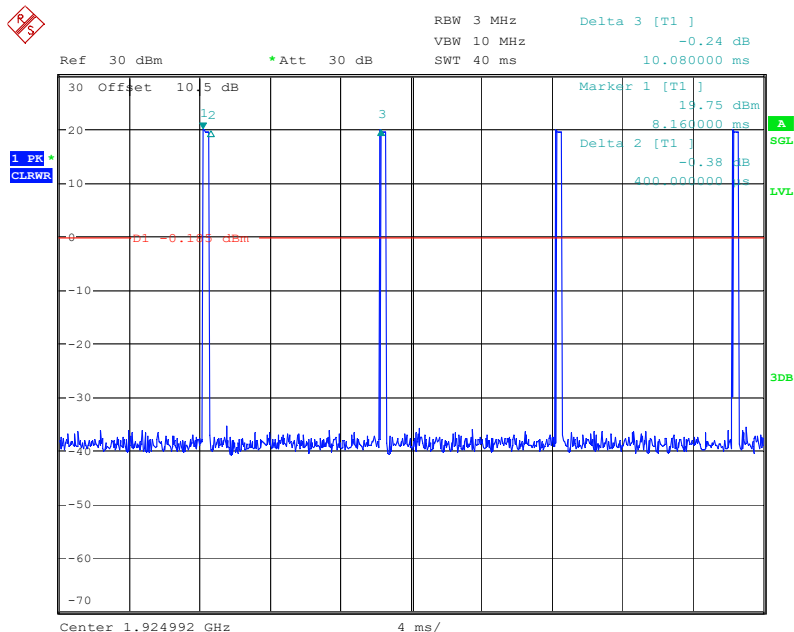

ProjectNo.:SZ1240103-00576E-PP Tester:Bruce Lin  
 Date: 25.MAR.2024 22:18:39



## STANDALONE SAR TEST EXCLUSION CONSIDERATIONS

### Antennas Location:

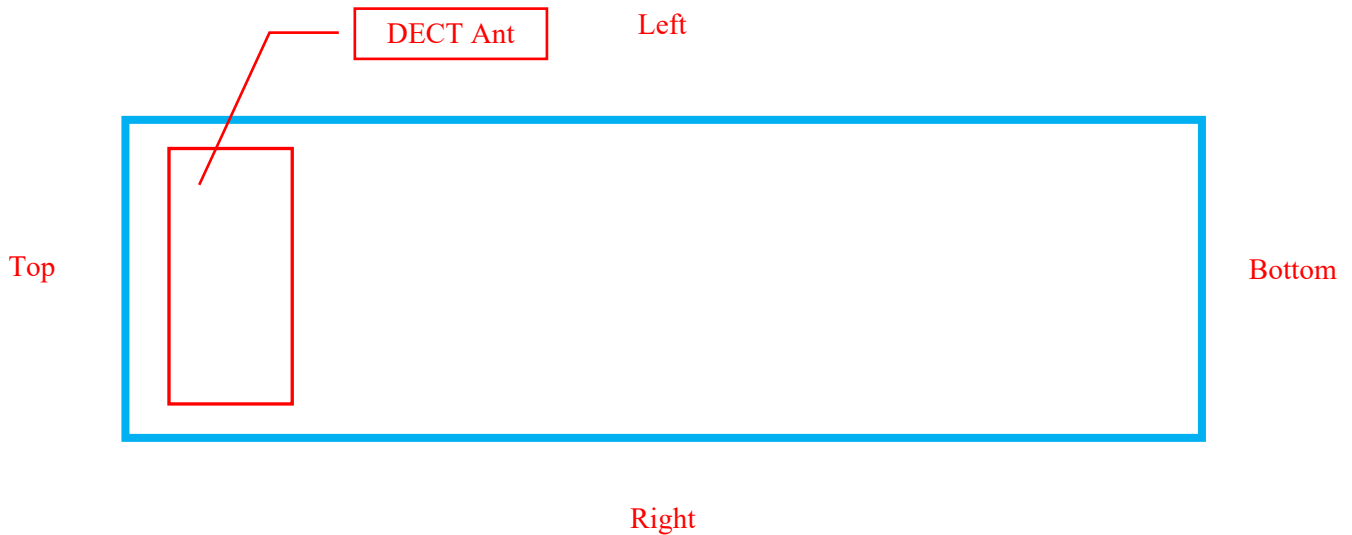

### EUT Back View

#### Standalone SAR test exclusion considerations

Mode	Frequency (MHz)	Output Power (dBm)	Output Power (mW)	Distance (mm)	Calculated value	Threshold (1-g)	SAR Test Exclusion
DECT	1928.448	20.2	104.71	0	29.1	3	NO

#### NOTE:

The 1-g and 10-g SAR test exclusion thresholds for 100 MHz to 6 GHz at test separation distances  $\leq 50$  mm are determined by:

$$[(\text{max. power of channel, including tune-up tolerance, mW}) / (\text{min. test separation distance, mm})] \cdot [\sqrt{f(\text{GHz})}] \leq 3.0 \text{ for 1-g SAR and } \leq 7.5 \text{ for 10-g extremity SAR, where}$$

1.  $f(\text{GHz})$  is the RF channel transmit frequency in GHz.

2. Power and distance are rounded to the nearest mW and mm before calculation.

3. The result is rounded to one decimal place for comparison.

4. When the minimum test separation distance is  $< 5$  mm, a distance of 5 mm is applied to determine SAR test Exclusion.

## SAR MEASUREMENT RESULTS

This page summarizes the results of the performed dosimetric evaluation.

### Test Results:

#### Environmental Conditions:

Temperature:	21.6 ~ 23.2°C
Relative Humidity:	40 ~ 59%
ATM Pressure:	101.3 kPa
Test Date:	2024/03/26

\* Testing was performed by Sid Luo.

#### DECTMode:

EUT Position	Frequency (MHz)	Test Mode	Max. Meas. Power (dBm)	Max. Rated Power (dBm)	1g SAR (W/Kg)				
					Scaled Factor	Meas. SAR	Scaled SAR	Limit	Plot
Head Left Cheek	1921.536	GFSK	19.94	20.2	1.062	0.039	0.05	1.6	1#
	1924.992	GFSK	19.77	20.2	1.104	0.056	<b>0.07</b>	1.6	2#
	1928.448	GFSK	19.75	20.2	1.109	0.041	0.05	1.6	3#
Head Left Tilt	1921.536	GFSK	/	/	/	/	/	1.6	/
	1924.992	GFSK	19.77	20.2	1.104	0.026	0.03	1.6	4#
	1928.448	GFSK	/	/	/	/	/	1.6	/
Head Right Cheek	1921.536	GFSK	/	/	/	/	/	1.6	/
	1924.992	GFSK	19.77	20.2	1.104	0.026	0.03	1.6	5#
	1928.448	GFSK	/	/	/	/	/	1.6	/
Head Right Tilt	1921.536	GFSK	/	/	/	/	/	1.6	/
	1924.992	GFSK	19.77	20.2	1.104	0.021	0.03	1.6	6#
	1928.448	GFSK	/	/	/	/	/	1.6	/
BodyFront (0 mm)	1921.536	GFSK	19.94	20.2	1.062	0.056	0.06	1.6	7#
	1924.992	GFSK	19.77	20.2	1.104	0.059	<b>0.07</b>	1.6	8#
	1928.448	GFSK	19.75	20.2	1.109	0.057	0.07	1.6	9#
BodyBack (0 mm)	1921.536	GFSK	/	/	/	/	/	1.6	/
	1924.992	GFSK	19.77	20.2	1.104	0.053	0.06	1.6	10#
	1928.448	GFSK	/	/	/	/	/	1.6	/

#### Note:

1. When the 1-g SAR is  $\leq 0.8W/Kg$ , testing for other channels are optional.
2. When SAR or MPE is not measured at the maximum power level allowed for production to the individual channels tested to determine compliance.

### SAR Measurement Variability

In accordance with published RF Exposure KDB procedure 865664 D01 SAR measurement 100 MHz to 6 GHz v01. These additional measurements are repeated after the completion of all measurements requiring the same head or body tissue-equivalent medium in a frequency band. The test device should be returned to ambient conditions (normal room temperature) with the battery fully charged before it is re-mounted on the device holder for the repeated measurement(s) to minimize any unexpected variations in the repeated results:

- 1) Repeated measurement is not required when the original highest measured SAR is < 0.80 W/kg; steps 2) through 4) do not apply.
- 2) When the original highest measured SAR is  $\geq 0.80$  W/kg, repeat that measurement once.
- 3) Perform a second repeated measurement only if the ratio of largest to smallest SAR for the original and first repeated measurements is > 1.20 or when the original or repeated measurement is  $\geq 1.45$  W/kg (~ 10% from the 1-g SAR limit).
- 4) Perform a third repeated measurement only if the original, first or second repeated measurement is  $\geq 1.5$  W/kg and the ratio of largest to smallest SAR for the original, first and second repeated measurements is > 1.20.

#### The Highest Measured SAR Configuration in Each Frequency Band

##### Head

SAR probe calibration point	Frequency Band	Freq.(MHz)	EUT Position	Meas. SAR (W/kg)		Largest to Smallest SAR Ratio
				Original	Repeated	
/	/	/	/	/	/	/

##### Body

SAR probe calibration point	Frequency Band	Freq.(MHz)	EUT Position	Meas. SAR (W/kg)		Largest to Smallest SAR Ratio
				Original	Repeated	
/	/	/	/	/	/	/

##### Note:

1. Second Repeated Measurement is not required since the ratio of the largest to smallest SAR for the original and first repeated measurement is not > 1.20.
2. The measured SAR results **do not** have to be scaled to the maximum tune-up tolerance to determine if repeated measurements are required.
3. SAR measurement variability must be assessed for each frequency band, which is determined by the **SAR probe calibration point and tissue-equivalent medium** used for the device measurements.

## SAR Plots

Plot: 1#

DUT: SIP cordless hotel phone; Type: PMX-S5410; Serial: 2G4S-12

Communication System: UID 0, DECT (0); Frequency: 1921.54 MHz;Duty Cycle: 1:25.2

Medium parameters used:  $f = 1921.54$  MHz;  $\sigma = 1.379$  S/m;  $\epsilon_r = 39.361$ ;  $\rho = 1000$  kg/m<sup>3</sup>

Phantom section: Left Section

DASY5 Configuration:

- Probe: EX3DV4 - SN7382; ConvF(8.3, 8.3, 8.3) @ 1921.54 MHz;
- Sensor-Surface: 1.4mm (Mechanical Surface Detection)
- Electronics: DAE4 Sn1325; Calibrated: 9/27/2023
- Phantom: SAM-Twin V8.0 P1aP2a; Type: QD 000 P41 AA ; Serial: 1962
- Measurement SW: DASY52, Version 52.10 (2);

Head Left Cheek/DECT Low/Area Scan (8x10x1): Measurement grid: dx=15mm, dy=15mm

Maximum value of SAR (measured) = 0.0599 W/kg

Head Left Cheek/DECT Low/Zoom Scan (5x5x7)/Cube 0: Measurement grid: dx=8mm, dy=8mm, dz=5mm

Reference Value = 3.383 V/m; Power Drift = 0.01 dB

Peak SAR (extrapolated) = 0.0740 W/kg

SAR(1 g) = 0.039 W/kg; SAR(10 g) = 0.014 W/kg

Maximum value of SAR (measured) = 0.0577 W/kg

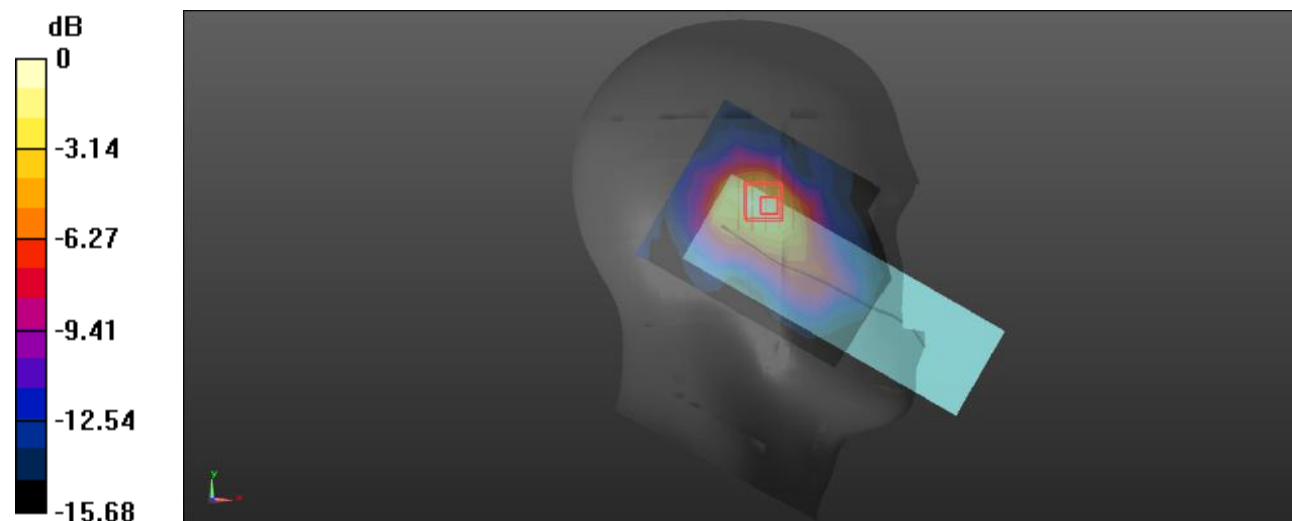

0 dB = 0.0577 W/kg = -12.39 dBW/kg

**Plot: 2#****DUT: SIP cordless hotel phone; Type: PMX-S5410; Serial: 2G4S-12**

Communication System: UID 0, DECT (0); Frequency: 1924.99 MHz;Duty Cycle: 1:25.2

Medium parameters used:  $f = 1924.99$  MHz;  $\sigma = 1.379$  S/m;  $\epsilon_r = 39.347$ ;  $\rho = 1000$  kg/m<sup>3</sup>

Phantom section: Left Section

DASY5 Configuration:

- Probe: EX3DV4 - SN7382; ConvF(8.3, 8.3, 8.3) @ 1924.99 MHz;
- Sensor-Surface: 1.4mm (Mechanical Surface Detection)
- Electronics: DAE4 Sn1325; Calibrated: 9/27/2023
- Phantom: SAM-Twin V8.0 P1aP2a; Type: QD 000 P41 AA ; Serial: 1962
- Measurement SW: DASY52, Version 52.10 (2);

**Head Left Cheek/DECT Mid/Area Scan (8x10x1):** Measurement grid: dx=15mm, dy=15mm

Maximum value of SAR (measured) = 0.0538 W/kg

**Head Left Cheek/DECT Mid/Zoom Scan (5x5x7)/Cube 0:** Measurement grid: dx=8mm, dy=8mm, dz=5mm

Reference Value = 3.295 V/m; Power Drift = 0.03 dB

Peak SAR (extrapolated) = 0.158 W/kg

**SAR(1 g) = 0.056 W/kg; SAR(10 g) = 0.021 W/kg**

Maximum value of SAR (measured) = 0.0576 W/kg

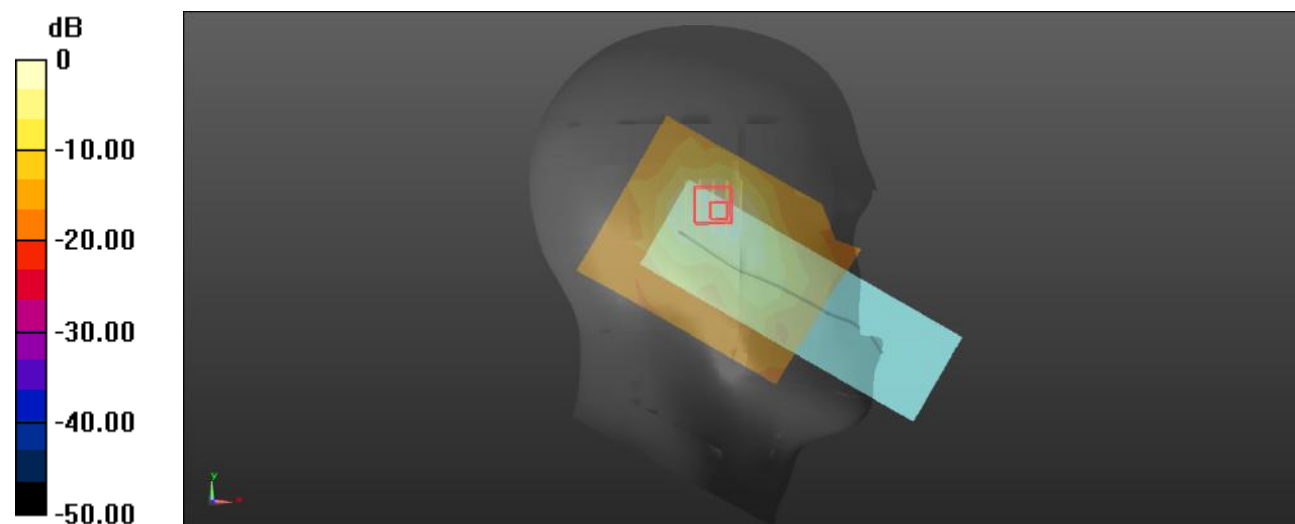

0 dB = 0.0576 W/kg = -12.40 dBW/kg

**Plot: 3#****DUT: SIP cordless hotel phone; Type: PMX-S5410; Serial: 2G4S-12**

Communication System: UID 0, DECT (0); Frequency: 1928.45 MHz;Duty Cycle: 1:25.2

Medium parameters used:  $f = 1928.45$  MHz;  $\sigma = 1.379$  S/m;  $\epsilon_r = 39.333$ ;  $\rho = 1000$  kg/m<sup>3</sup>

Phantom section: Left Section

DASY5 Configuration:

- Probe: EX3DV4 - SN7382; ConvF(8.3, 8.3, 8.3) @ 1928.45 MHz;
- Sensor-Surface: 1.4mm (Mechanical Surface Detection)
- Electronics: DAE4 Sn1325; Calibrated: 9/27/2023
- Phantom: SAM-Twin V8.0 P1aP2a; Type: QD 000 P41 AA ; Serial: 1962
- Measurement SW: DASY52, Version 52.10 (2);

**Head Left Cheek/DECT High/Area Scan (8x10x1):** Measurement grid: dx=15mm, dy=15mm

Maximum value of SAR (measured) = 0.0611 W/kg

**Head Left Cheek/DECT High/Zoom Scan (5x5x7)/Cube 0:** Measurement grid: dx=8mm, dy=8mm, dz=5mm

Reference Value = 3.402 V/m; Power Drift = -0.08 dB

Peak SAR (extrapolated) = 0.0730 W/kg

**SAR(1 g) = 0.041 W/kg; SAR(10 g) = 0.023 W/kg**

Maximum value of SAR (measured) = 0.0600 W/kg

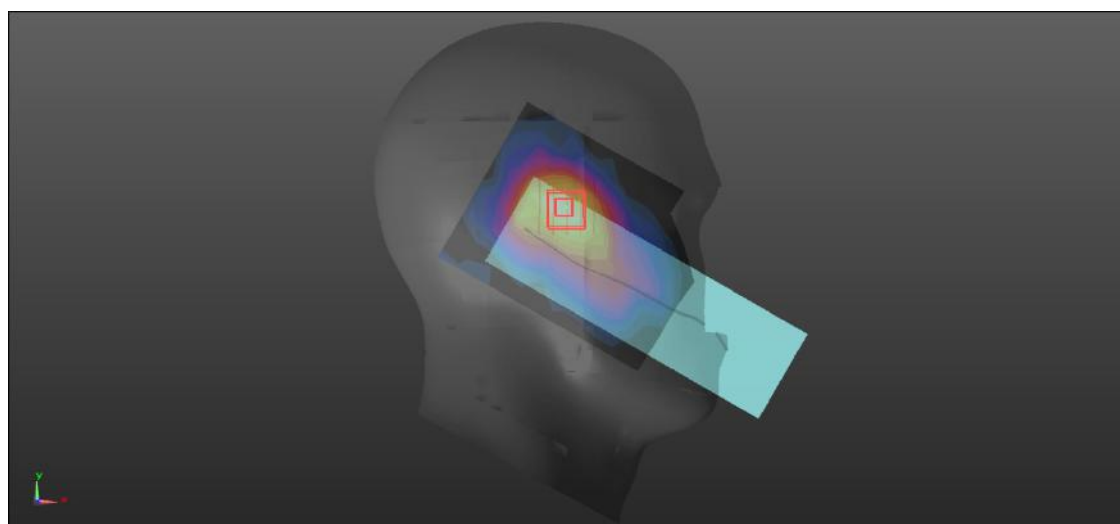
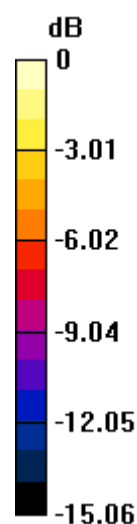

0 dB = 0.0600 W/kg = -12.22 dBW/kg

**Plot: 4#****DUT: SIP cordless hotel phone; Type: PMX-S5410; Serial: 2G4S-12**

Communication System: UID 0, DECT (0); Frequency: 1924.99 MHz;Duty Cycle: 1:25.2

Medium parameters used:  $f = 1924.99$  MHz;  $\sigma = 1.379$  S/m;  $\epsilon_r = 39.347$ ;  $\rho = 1000$  kg/m<sup>3</sup>

Phantom section: Left Section

DASY5 Configuration:

- Probe: EX3DV4 - SN7382; ConvF(8.3, 8.3, 8.3) @ 1924.99 MHz;
- Sensor-Surface: 1.4mm (Mechanical Surface Detection)
- Electronics: DAE4 Sn1325; Calibrated: 9/27/2023
- Phantom: SAM-Twin V8.0 P1aP2a; Type: QD 000 P41 AA ; Serial: 1962
- Measurement SW: DASY52, Version 52.10 (2);

**Head Left Tilt/DECT Mid/Area Scan (8x10x1):** Measurement grid: dx=15mm, dy=15mm

Maximum value of SAR (measured) = 0.0374 W/kg

**Head Left Tilt/DECT Mid/Zoom Scan (5x5x7)/Cube 0:** Measurement grid: dx=8mm, dy=8mm, dz=5mm

Reference Value = 3.400 V/m; Power Drift = -0.08 dB

Peak SAR (extrapolated) = 0.0460 W/kg

**SAR(1 g) = 0.026 W/kg; SAR(10 g) = 0.015 W/kg**

Maximum value of SAR (measured) = 0.0363 W/kg

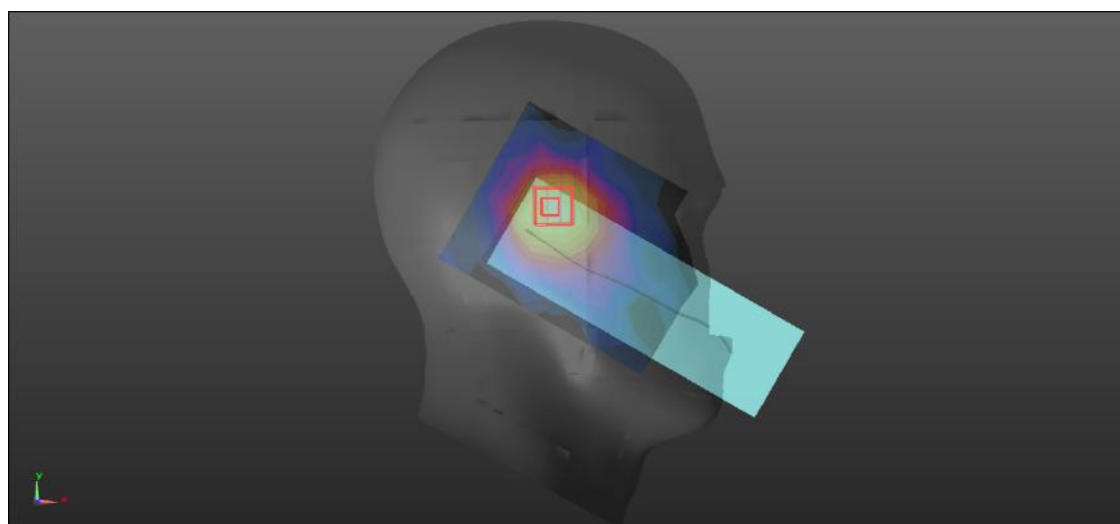
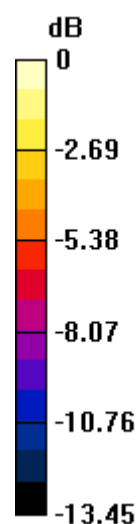

0 dB = 0.0363 W/kg = -14.40 dBW/kg

**Plot: 5#**

**DUT: SIP cordless hotel phone; Type: PMX-S5410; Serial: 2G4S-12**

Communication System: UID 0, DECT (0); Frequency: 1924.99 MHz;Duty Cycle: 1:25.2

Medium parameters used:  $f = 1924.99$  MHz;  $\sigma = 1.379$  S/m;  $\epsilon_r = 39.347$ ;  $\rho = 1000$  kg/m<sup>3</sup>

Phantom section: Right Section

DASY5 Configuration:

- Probe: EX3DV4 - SN7382; ConvF(8.3, 8.3, 8.3) @ 1924.99 MHz;
- Sensor-Surface: 1.4mm (Mechanical Surface Detection)
- Electronics: DAE4 Sn1325; Calibrated: 9/27/2023
- Phantom: SAM-Twin V8.0 P1aP2a; Type: QD 000 P41 AA ; Serial: 1962
- Measurement SW: DASY52, Version 52.10 (2);

**Head Right Cheek/DECT Mid/Area Scan (8x10x1):** Measurement grid: dx=15mm, dy=15mm

Maximum value of SAR (measured) = 0.0381 W/kg

**Head Right Cheek/DECT Mid/Zoom Scan (5x5x7)/Cube 0:** Measurement grid: dx=8mm, dy=8mm, dz=5mm

Reference Value = 3.712 V/m; Power Drift = 0.11 dB

Peak SAR (extrapolated) = 0.0450 W/kg

**SAR(1 g) = 0.026 W/kg; SAR(10 g) = 0.014 W/kg**

Maximum value of SAR (measured) = 0.0375 W/kg

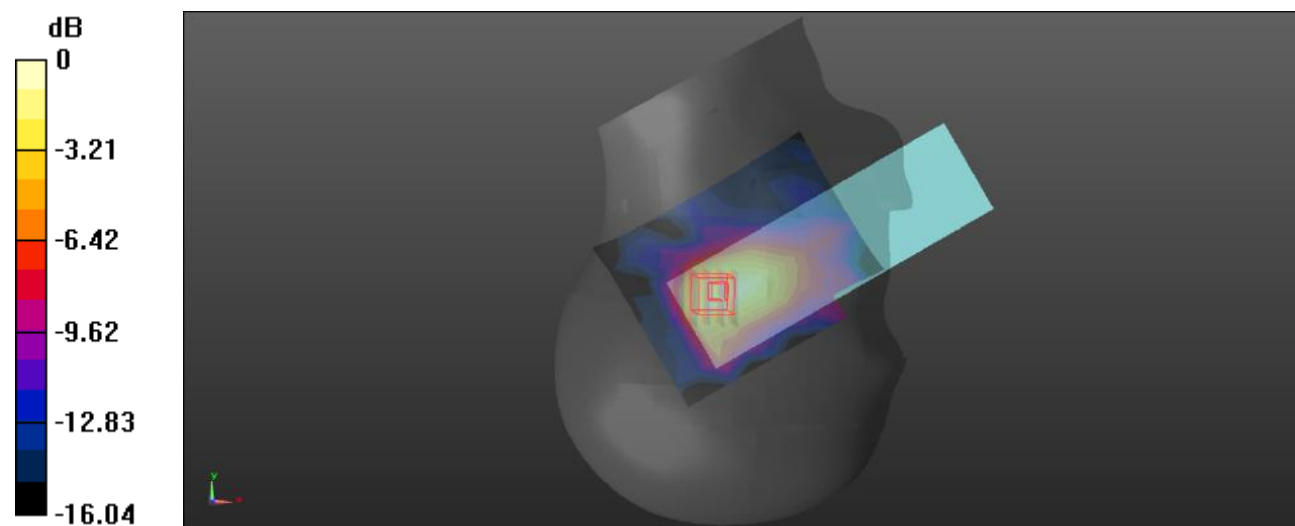

0 dB = 0.0375 W/kg = -14.26 dBW/kg



**Plot: 6#**

**DUT: SIP cordless hotel phone; Type: PMX-S5410; Serial: 2G4S-12**

Communication System: UID 0, DECT (0); Frequency: 1924.99 MHz; Duty Cycle: 1:25.2

Medium parameters used:  $f = 1924.99$  MHz;  $\sigma = 1.379$  S/m;  $\epsilon_r = 39.347$ ;  $\rho = 1000$  kg/m<sup>3</sup>

Phantom section: Right Section

DASY5 Configuration:

- Probe: EX3DV4 - SN7382; ConvF(8.3, 8.3, 8.3) @ 1924.99 MHz;
- Sensor-Surface: 1.4mm (Mechanical Surface Detection)
- Electronics: DAE4 Sn1325; Calibrated: 9/27/2023
- Phantom: SAM-Twin V8.0 P1aP2a; Type: QD 000 P41 AA ; Serial: 1962
- Measurement SW: DASY52, Version 52.10 (2);

**Head Right Tilt/DECT Mid/Area Scan (8x10x1):** Measurement grid: dx=15mm, dy=15mm

Maximum value of SAR (measured) = 0.0288 W/kg

**Head Right Tilt/DECT Mid/Zoom Scan (5x5x7)/Cube 0:** Measurement grid: dx=8mm, dy=8mm, dz=5mm

Reference Value = 3.713 V/m; Power Drift = -0.19 dB

Peak SAR (extrapolated) = 0.0370 W/kg

**SAR(1 g) = 0.021 W/kg; SAR(10 g) = 0.012 W/kg**

Maximum value of SAR (measured) = 0.0303 W/kg

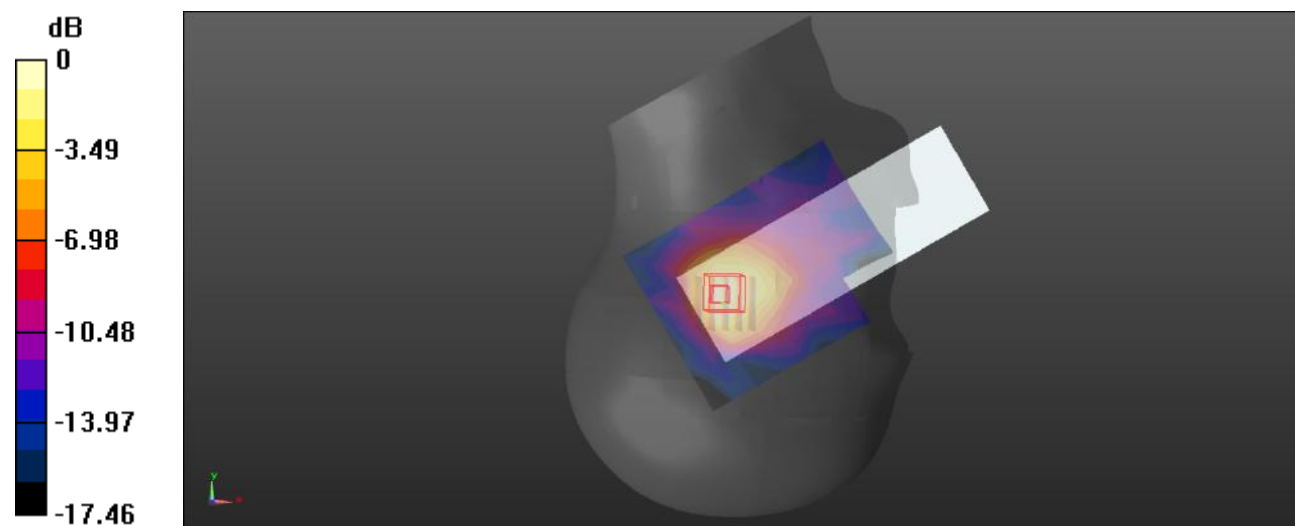

0 dB = 0.0303 W/kg = -15.19 dBW/kg

**Plot: 7#****DUT: SIP cordless hotel phone; Type: PMX-S5410; Serial: 2G4S-12**

Communication System: UID 0, DECT (0); Frequency: 1921.54 MHz; Duty Cycle: 1:25.2

Medium parameters used:  $f = 1921.54$  MHz;  $\sigma = 1.379$  S/m;  $\epsilon_r = 39.361$ ;  $\rho = 1000$  kg/m<sup>3</sup>

Phantom section: Flat Section

DASY5 Configuration:

- Probe: EX3DV4 - SN7382; ConvF(8.3, 8.3, 8.3) @ 1921.54 MHz;
- Sensor-Surface: 1.4mm (Mechanical Surface Detection)
- Electronics: DAE4 Sn1325; Calibrated: 9/27/2023
- Phantom: SAM-Twin V8.0 P1aP2a; Type: QD 000 P41 AA ; Serial: 1962
- Measurement SW: DASY52, Version 52.10 (2);

**Body Front/DECT Low/Area Scan (8x10x1):** Measurement grid: dx=15mm, dy=15mm

Maximum value of SAR (measured) = 0.0818 W/kg

**Body Front/DECT Low/Zoom Scan (5x5x7)/Cube 0:** Measurement grid: dx=8mm, dy=8mm, dz=5mm

Reference Value = 3.075 V/m; Power Drift = 0.10 dB

Peak SAR (extrapolated) = 0.115 W/kg

**SAR(1 g) = 0.056 W/kg; SAR(10 g) = 0.028 W/kg**

Maximum value of SAR (measured) = 0.0885 W/kg

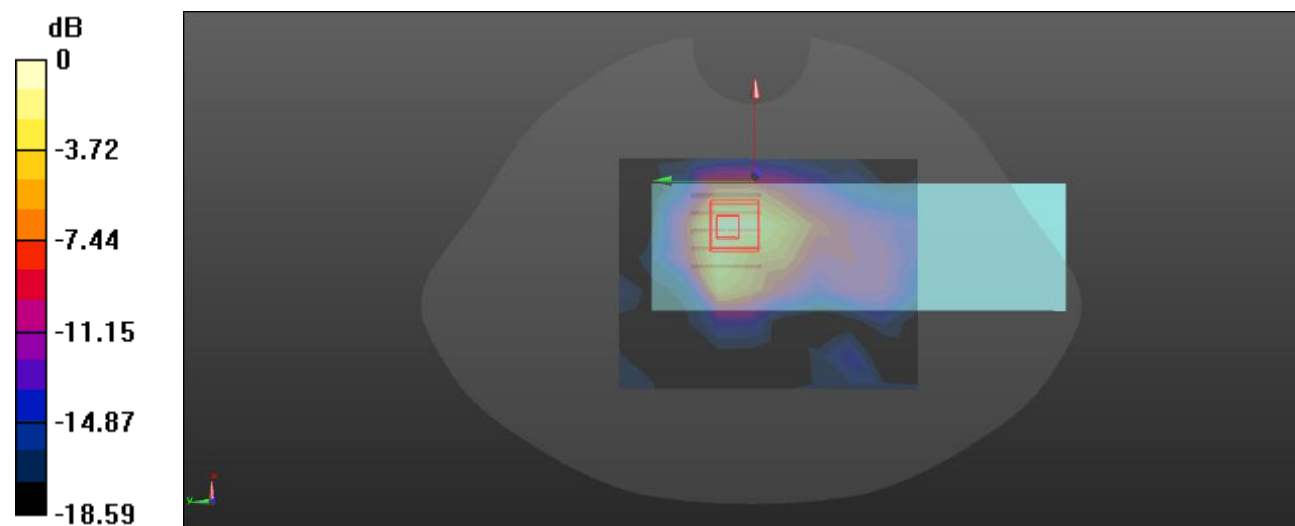

0 dB = 0.0885 W/kg = -10.53 dBW/kg

**Plot: 8#**

**DUT: SIP cordless hotel phone; Type: PMX-S5410; Serial: 2G4S-12**

Communication System: UID 0, DECT (0); Frequency: 1924.99 MHz;Duty Cycle: 1:25.2

Medium parameters used:  $f = 1924.99$  MHz;  $\sigma = 1.379$  S/m;  $\epsilon_r = 39.347$ ;  $\rho = 1000$  kg/m<sup>3</sup>

Phantom section: Flat Section

DASY5 Configuration:

- Probe: EX3DV4 - SN7382; ConvF(8.3, 8.3, 8.3) @ 1924.99 MHz;
- Sensor-Surface: 1.4mm (Mechanical Surface Detection)
- Electronics: DAE4 Sn1325; Calibrated: 9/27/2023
- Phantom: SAM-Twin V8.0 P1aP2a; Type: QD 000 P41 AA ; Serial: 1962
- Measurement SW: DASY52, Version 52.10 (2);

**Body Front/DECT Mid/Area Scan (8x10x1):** Measurement grid: dx=15mm, dy=15mm

Maximum value of SAR (measured) = 0.0842 W/kg

**Body Front/DECT Mid/Zoom Scan (5x5x7)/Cube 0:** Measurement grid: dx=8mm, dy=8mm, dz=5mm

Reference Value = 3.039 V/m; Power Drift = 0.13 dB

Peak SAR (extrapolated) = 0.270 W/kg

**SAR(1 g) = 0.059 W/kg; SAR(10 g) = 0.022 W/kg**

Maximum value of SAR (measured) = 0.0860 W/kg

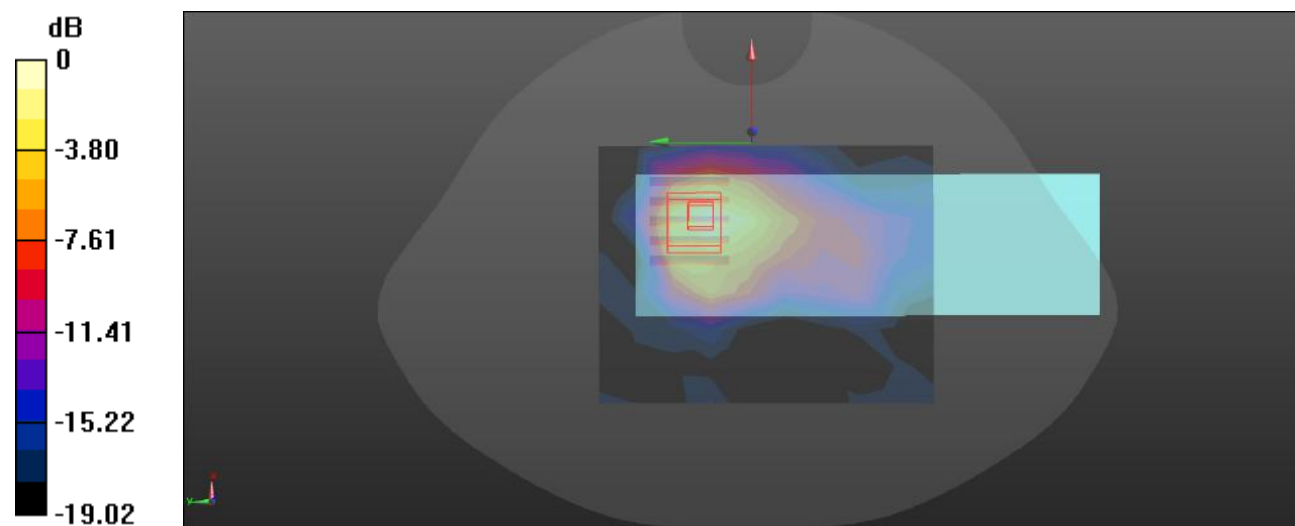

0 dB = 0.0860 W/kg = -10.66 dBW/kg

**Plot: 9#**

**DUT: SIP cordless hotel phone; Type: PMX-S5410; Serial: 2G4S-12**

Communication System: UID 0, DECT (0); Frequency: 1928.45 MHz;Duty Cycle: 1:25.2

Medium parameters used:  $f = 1928.45 \text{ MHz}$ ;  $\sigma = 1.379 \text{ S/m}$ ;  $\epsilon_r = 39.333$ ;  $\rho = 1000 \text{ kg/m}^3$

Phantom section: Flat Section

DASY5 Configuration:

- Probe: EX3DV4 - SN7382; ConvF(8.3, 8.3, 8.3) @ 1928.45 MHz;
- Sensor-Surface: 1.4mm (Mechanical Surface Detection)
- Electronics: DAE4 Sn1325; Calibrated: 9/27/2023
- Phantom: SAM-Twin V8.0 P1aP2a; Type: QD 000 P41 AA ; Serial: 1962
- Measurement SW: DASY52, Version 52.10 (2);

**Body Front/DECT High/Area Scan (8x10x1):** Measurement grid: dx=15mm, dy=15mm

Maximum value of SAR (measured) = 0.0846 W/kg

**Body Front/DECT High/Zoom Scan (5x5x7)/Cube 0:** Measurement grid: dx=8mm, dy=8mm, dz=5mm

Reference Value = 2.970 V/m; Power Drift = 0.08 dB

Peak SAR (extrapolated) = 0.117 W/kg

**SAR(1 g) = 0.057 W/kg; SAR(10 g) = 0.028 W/kg**

Maximum value of SAR (measured) = 0.0902 W/kg

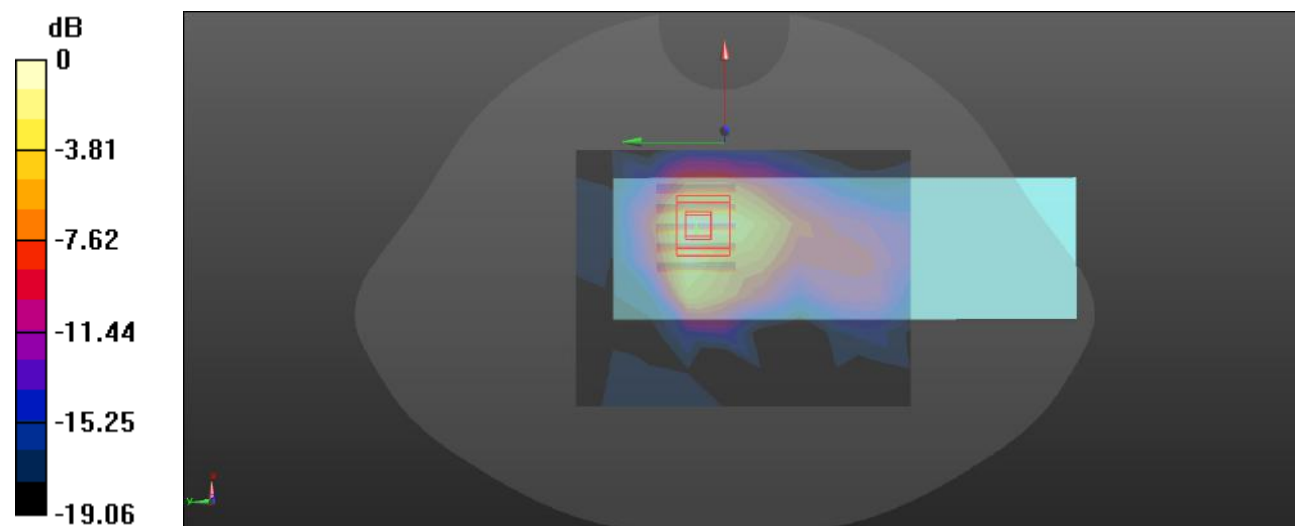

0 dB = 0.0902 W/kg = -10.45 dBW/kg

**Plot: 10#**

**DUT: SIP cordless hotel phone; Type: PMX-S5410; Serial: 2G4S-12**

Communication System: UID 0, DECT (0); Frequency: 1924.99 MHz;Duty Cycle: 1:25.2

Medium parameters used:  $f = 1924.99$  MHz;  $\sigma = 1.379$  S/m;  $\epsilon_r = 39.347$ ;  $\rho = 1000$  kg/m<sup>3</sup>

Phantom section: Flat Section

DASY5 Configuration:

- Probe: EX3DV4 - SN7382; ConvF(8.3, 8.3, 8.3) @ 1924.99 MHz;
- Sensor-Surface: 1.4mm (Mechanical Surface Detection)
- Electronics: DAE4 Sn1325; Calibrated: 9/27/2023
- Phantom: SAM-Twin V8.0 P1aP2a; Type: QD 000 P41 AA ; Serial: 1962
- Measurement SW: DASY52, Version 52.10 (2);

**Body Back/DECT Mid/Area Scan (8x10x1):** Measurement grid: dx=15mm, dy=15mm

Maximum value of SAR (measured) = 0.0701 W/kg

**Body Back/DECT Mid/Zoom Scan (5x5x7)/Cube 0:** Measurement grid: dx=8mm, dy=8mm, dz=5mm

Reference Value = 4.471 V/m; Power Drift = -0.18 dB

Peak SAR (extrapolated) = 0.109 W/kg

**SAR(1 g) = 0.053 W/kg; SAR(10 g) = 0.026 W/kg**

Maximum value of SAR (measured) = 0.0864 W/kg

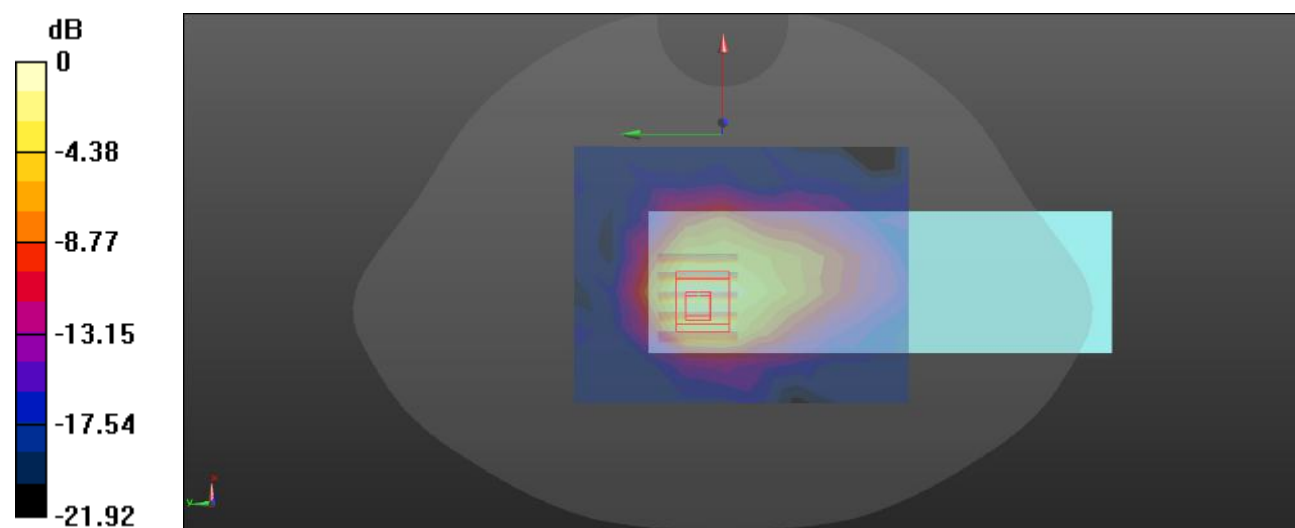

0 dB = 0.0864 W/kg = -10.63 dBW/kg

### APPENDIX A MEASUREMENT UNCERTAINTY

The uncertainty budget has been determined for the measurement system and is given in the following Table.

**Measurement uncertainty evaluation for IEEE1528-2013 SAR test**

Source of uncertainty	Tolerance/uncertainty ± %	Probability distribution	Divisor	ci (1 g)	ci (10 g)	Standard uncertainty ± %, (1 g)	Standard uncertainty ± %, (10 g)
<b>Measurement system</b>							
Probe calibration	13.9	N	1	1	1	13.9	13.9
Axial Isotropy	4.7	R	√3	1	1	2.7	2.7
Hemispherical Isotropy	9.6	R	√3	0	0	0.0	0.0
Boundary effect	1.0	R	√3	1	1	0.6	0.6
Linearity	4.7	R	√3	1	1	2.7	2.7
Detection limits	1.0	R	√3	1	1	0.6	0.6
Modulation response	4.0	R	√3	1	1	2.3	2.3
Readout electronics	0.3	N	1	1	1	0.3	0.3
Response time	0.0	R	√3	1	1	0.0	0.0
Integration time	0.0	R	√3	1	1	0.0	0.0
RF ambient conditions – noise	1.0	R	√3	1	1	0.6	0.6
RF ambient conditions–reflections	1.0	R	√3	1	1	0.6	0.6
Probe positioner mech. Restrictions	0.8	R	√3	1	1	0.5	0.5
Probe positioning with respect to phantom shell	6.7	R	√3	1	1	3.9	3.9
Extrapolation, interpolation, and integrations algorithms for max. SAR evaluation	3.9	R	√3	1	1	2.3	2.3
<b>Test sample related</b>							
Test sample positioning	2.8	N	1	1	1	2.8	2.8
Device holder uncertainty	6.3	N	1	1	1	6.3	6.3
Drift of output power	5.0	R	√3	1	1	2.9	2.9
SAR scaling	2.0	R	√3	1	1	1.2	1.2
<b>Phantom and tissue parameters</b>							
Phantom uncertainty (shape and thickness tolerances)	4.0	R	√3	1	1	2.3	2.3
Uncertainty in SAR correction for deviations in permittivity and conductivity	1.9	N	1	1	0.84	1.9	1.6
Liquid conductivity measurement	5.5	N	1	0.78	0.71	4.3	3.9
Liquid permittivity measurement	2.9	N	1	0.23	0.26	0.7	0.8
Liquid conductivity—temperature uncertainty	1.7	R	√3	0.78	0.71	0.8	0.7
Liquid permittivity—temperature uncertainty	2.7	R	√3	0.23	0.26	0.4	0.4
Combined standard uncertainty		RSS				12.2	12.0
Expanded uncertainty 95 % confidence interval)						24.3	23.9

## APPENDIX B EUT TEST POSITION PHOTOS

**Liquid depth  $\geq 15\text{cm}$**

Phantom: SAM-Twin V8.0 P1aP2a; Type: QD 000 P41 AA ; Serial: 1962

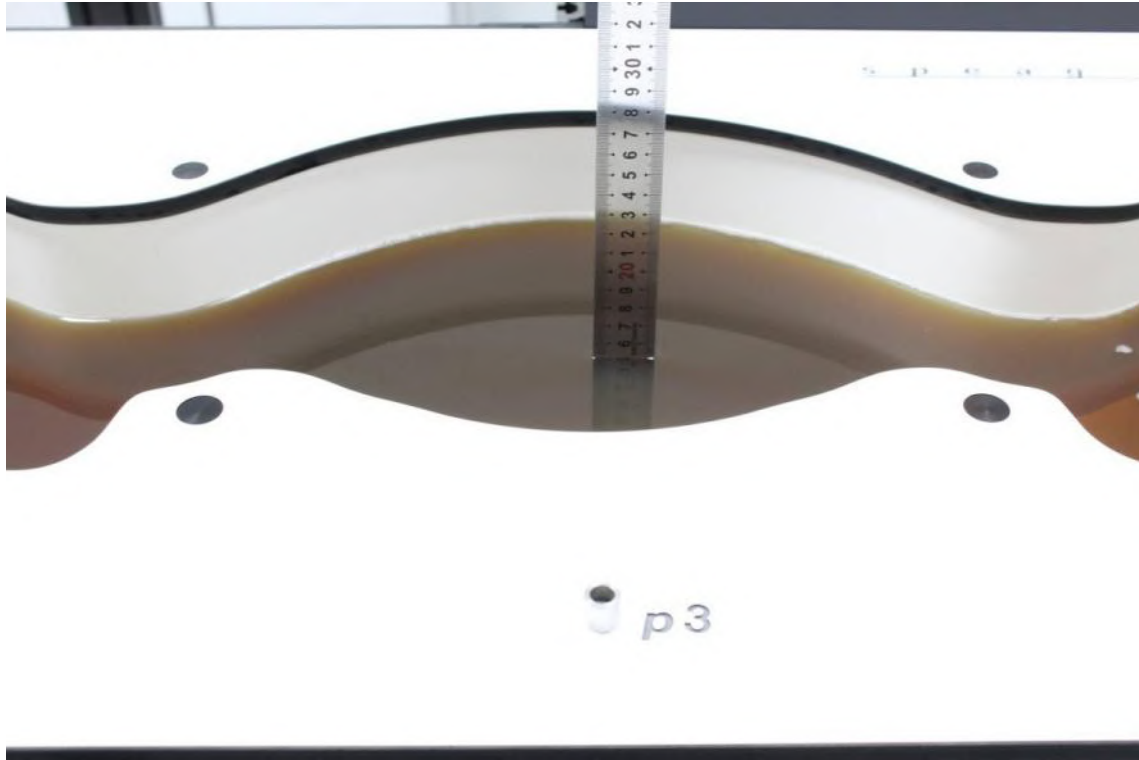

**Head Left CheekSetup Photo (0 mm)**



**Head Left TiltSetup Photo (0 mm)**





**Head Right CheekSetup Photo (0 mm)**

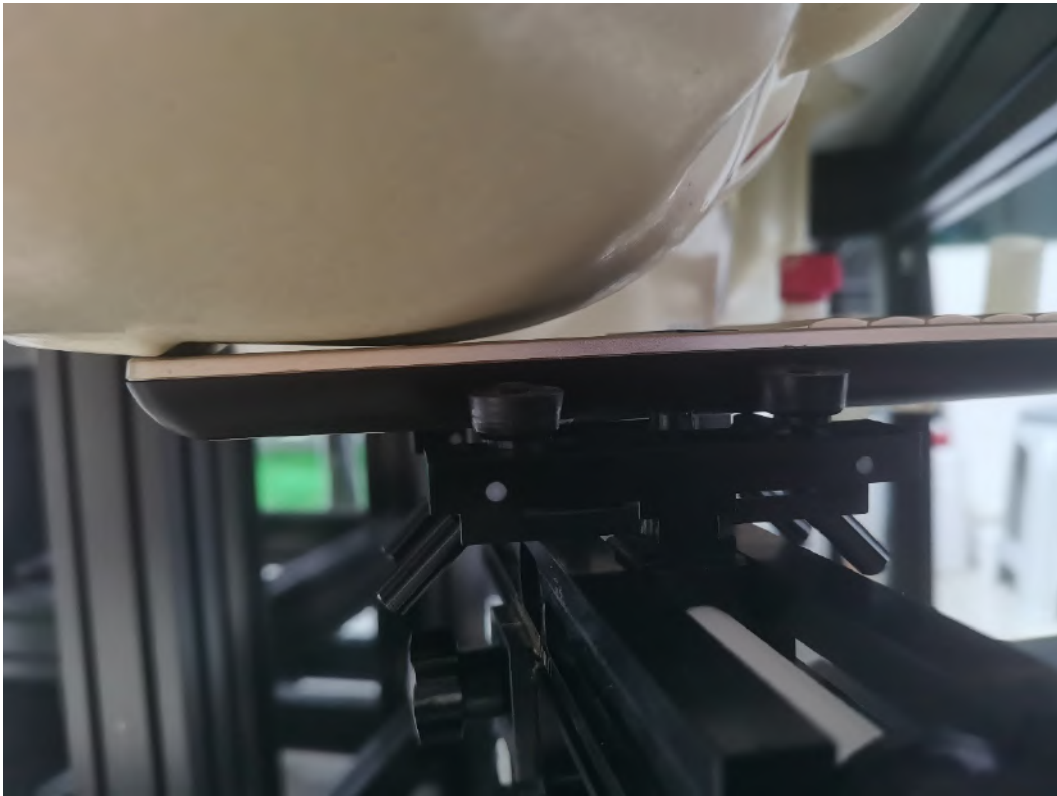

**Head Right TiltSetup Photo (0 mm)**



**Body FrontSetup Photo (0 mm)**



**Body BackSetup Photo (0 mm)**



# APPENDIX C PROBE CALIBRATION CERTIFICATES



Add: No.52 HuaYuanBei Road, Haidian District, Beijing, 100191, China  
 Tel: +86-10-62304633-2117  
 E-mail: emf@caict.ac.cn http://www.caict.ac.cn



Client **BACL**

Certificate No: **J23Z60359**

CALIBRATION CERTIFICATE			
Object	EX3DV4 - SN : 7382		
Calibration Procedure(s)	FF-Z11-004-02 Calibration Procedures for Dosimetric E-field Probes		
Calibration date:	September 27, 2023		
This calibration Certificate documents the traceability to national standards, which realize the physical units of measurements(SI). The measurements and the uncertainties with confidence probability are given on the following pages and are part of the certificate.			
All calibrations have been conducted in the closed laboratory facility: environment temperature(22±3)°C and humidity<70%.			
Calibration Equipment used (M&TE critical for calibration)			
Primary Standards	ID #	Cal Date(Calibrated by, Certificate No.)	Scheduled Calibration
Power Meter NRP2	101919	12-Jun-23(CTTL, No.J23X05435)	Jun-24
Power sensor NRP-Z91	101547	12-Jun-23(CTTL, No.J23X05435)	Jun-24
Power sensor NRP-Z91	101548	12-Jun-23(CTTL, No.J23X05435)	Jun-24
Reference 10dBAttenuator	18N50W-10dB	19-Jan-23(CTTL, No.J23X00212)	Jan-25
Reference 20dBAttenuator	18N50W-20dB	19-Jan-23(CTTL, No.J23X00211)	Jan-25
Reference Probe EX3DV4	SN 3846	31-May-23(SPEAG, No.EX-3846_May23)	May-24
DAE4	SN 1555	24-Aug-23(SPEAG, No.DAE4-1555_Aug23)	Aug-24
DAE4	SN 549	24-Jan-23(SPEAG, No.DAE4-549_Jan23)	Jan-24
Secondary Standards	ID #	Cal Date(Calibrated by, Certificate No.)	Scheduled Calibration
SignalGenerator MG3700A	6201052605	12-Jun-23(CTTL, No.J23X05434)	Jun-24
Network Analyzer E5071C	MY46110673	10-Jan-23(CTTL, No.J23X00104)	Jan-24
Reference 10dBAttenuator	BT0520	11-May-23(CTTL, No.J23X04061)	May-25
Reference 20dBAttenuator	BT0267	11-May-23(CTTL, No.J23X04062)	May-25
OCP DAK-3.5	SN 1040	18-Jan-23(SPEAG, No.OCP-DAK3.5-1040_Jan23)	Jan-24
	Name	Function	Signature
Calibrated by:	Yu Zongying	SAR Test Engineer	
Reviewed by:	Lin Hao	SAR Test Engineer	
Approved by:	Qi Dianyuan	SAR Project Leader	
			Issued: October 05, 2023
This calibration certificate shall not be reproduced except in full without written approval of the laboratory.			

Certificate No: J23Z60359

Page 1 of 9





Add: No.52 HuaYuanBei Road, Haidian District, Beijing, 100191, China  
 Tel: +86-10-62304633-2117  
 E-mail: emf@caict.ac.cn <http://www.caict.ac.cn>



### Glossary:

TSL	tissue simulating liquid
NORM <sub>x,y,z</sub>	sensitivity in free space
ConvF	sensitivity in TSL / NORM <sub>x,y,z</sub>
DCP	diode compression point
CF	crest factor (1/duty_cycle) of the RF signal
A,B,C,D	modulation dependent linearization parameters
Polarization $\Phi$	$\Phi$ rotation around probe axis
Polarization $\theta$	$\theta$ rotation around an axis that is in the plane normal to probe axis (at measurement center), i $\theta=0$ is normal to probe axis
Connector Angle	information used in DASY system to align probe sensor X to the robot coordinate system

### Calibration is Performed According to the Following Standards:

- IEEE Std 1528-2013, "IEEE Recommended Practice for Determining the Peak Spatial-Averaged Specific Absorption Rate (SAR) in the Human Head from Wireless Communications Devices: Measurement Techniques", June 2013
- IEC 62209-1, "Measurement procedure for the assessment of Specific Absorption Rate (SAR) from hand-held and body-mounted devices used next to the ear (frequency range of 300 MHz to 6 GHz)", July 2016
- IEC 62209-2, "Procedure to determine the Specific Absorption Rate (SAR) for wireless communication devices used in close proximity to the human body (frequency range of 30 MHz to 6 GHz)", March 2010
- KDB 865664, "SAR Measurement Requirements for 100 MHz to 6 GHz"

### Methods Applied and Interpretation of Parameters:

- NORM<sub>x,y,z</sub>:** Assessed for E-field polarization  $\theta=0$  ( $f \leq 900$  MHz in TEM-cell;  $f > 1800$  MHz: waveguide). NORM<sub>x,y,z</sub> are only intermediate values, i.e., the uncertainties of NORM<sub>x,y,z</sub> does not effect the  $E^2$ -field uncertainty inside TSL (see below ConvF).
- NORM( $f$ )<sub>x,y,z</sub> = NORM<sub>x,y,z</sub> \* frequency\_response** (see Frequency Response Chart). This linearization is implemented in DASY4 software versions later than 4.2. The uncertainty of the frequency response is included in the stated uncertainty of ConvF.
- DCP<sub>x,y,z</sub>:** DCP are numerical linearization parameters assessed based on the data of power sweep (no uncertainty required). DCP does not depend on frequency nor media.
- PAR:** PAR is the Peak to Average Ratio that is not calibrated but determined based on the signal characteristics.
- A<sub>x,y,z</sub>; B<sub>x,y,z</sub>; C<sub>x,y,z</sub>; VR<sub>x,y,z</sub>; A,B,C** are numerical linearization parameters assessed based on the data of power sweep for specific modulation signal. The parameters do not depend on frequency nor media. VR is the maximum calibration range expressed in RMS voltage across the diode.
- ConvF and Boundary Effect Parameters:** Assessed in flat phantom using E-field (or Temperature Transfer Standard for  $f \leq 800$  MHz) and inside waveguide using analytical field distributions based on power measurements for  $f > 800$  MHz. The same setups are used for assessment of the parameters applied for boundary compensation (alpha, depth) of which typical uncertainty valued are given. These parameters are used in DASY4 software to improve probe accuracy close to the boundary. The sensitivity in TSL corresponds to NORM<sub>x,y,z</sub> \* ConvF whereby the uncertainty corresponds to that given for ConvF. A frequency dependent ConvF is used in DASY version 4.4 and higher which allows extending the validity from  $\pm 50$  MHz to  $\pm 100$  MHz.
- Spherical isotropy (3D deviation from isotropy):** in a field of low gradients realized using a flat phantom exposed by a patch antenna.
- Sensor Offset:** The sensor offset corresponds to the offset of virtual measurement center from the probe tip (on probe axis). No tolerance required.
- Connector Angle:** The angle is assessed using the information gained by determining the NORM<sub>x</sub> (no uncertainty required).



Add: No.52 HuaYuanBei Road, Haidian District, Beijing, 100191, China  
 Tel: +86-10-62304633-2117  
 E-mail: emf@caict.ac.cn      http://www.caict.ac.cn

**DASY/EASY – Parameters of Probe: EX3DV4 – SN:7382**

**Basic Calibration Parameters**

	Sensor X	Sensor Y	Sensor Z	Unc (k=2)
Norm( $\mu\text{V}/(\text{V}/\text{m})^2$ ) <sup>A</sup>	0.42	0.42	0.47	±10.0%
DCP(mV) <sup>B</sup>	100.8	101.0	103.5	

**Modulation Calibration Parameters**

UID	Communication System Name		A dB	B dB $\sqrt{\mu\text{V}}$	C	D dB	VR mV	Unc <sup>E</sup> (k=2)
0	CW	X	0.0	0.0	1.0	0.00	160.9	±2.0%
		Y	0.0	0.0	1.0		159.5	
		Z	0.0	0.0	1.0		178.1	

The reported uncertainty of measurement is stated as the standard uncertainty of Measurement multiplied by the coverage factor  $k=2$ , which for a normal distribution Corresponds to a coverage probability of approximately 95%.

<sup>A</sup> The uncertainties of Norm X, Y, Z do not affect the E<sup>2</sup>-field uncertainty inside TSL (see Page 4).  
<sup>B</sup> Numerical linearization parameter: uncertainty not required.  
<sup>E</sup> Uncertainty is determined using the max. deviation from linear response applying rectangular distribution and is expressed for the square of the field value.



Add: No.52 HuaYuanBei Road, Haidian District, Beijing, 100191, China  
 Tel: +86-10-62304633-2117  
 E-mail: emf@caict.ac.cn http://www.caict.ac.cn



**DASY/EASY – Parameters of Probe: EX3DV4 – SN:7382**

**Calibration Parameter Determined in Head Tissue Simulating Media**

f [MHz] <sup>C</sup>	Relative Permittivity <sup>F</sup>	Conductivity (S/m) <sup>F</sup>	ConvF X	ConvF Y	ConvF Z	Alpha <sup>G</sup>	Depth <sup>G</sup> (mm)	Unct. (k=2)
750	41.9	0.89	10.65	10.65	10.65	0.17	1.24	±12.7%
900	41.5	0.97	10.19	10.19	10.19	0.20	1.15	±12.7%
1750	40.1	1.37	8.60	8.60	8.60	0.26	0.97	±12.7%
1900	40.0	1.40	8.30	8.30	8.30	0.25	1.01	±12.7%
2300	39.5	1.67	8.16	8.16	8.16	0.60	0.68	±12.7%
2450	39.2	1.80	7.89	7.89	7.89	0.45	0.86	±12.7%
2600	39.0	1.96	7.65	7.65	7.65	0.53	0.77	±12.7%
3300	38.2	2.71	7.39	7.39	7.39	0.49	0.86	±13.9%
3500	37.9	2.91	7.24	7.24	7.24	0.41	1.03	±13.9%
3700	37.7	3.12	7.10	7.10	7.10	0.43	1.03	±13.9%
3900	37.5	3.32	6.98	6.98	6.98	0.40	1.25	±13.9%
5250	35.9	4.71	5.62	5.62	5.62	0.50	1.25	±13.9%
5500	35.6	4.96	5.10	5.10	5.10	0.40	1.50	±13.9%
5750	35.4	5.22	5.08	5.08	5.08	0.40	1.52	±13.9%

<sup>C</sup> Frequency validity above 300 MHz of ±100MHz only applies for DASY v4.4 and higher (Page 2), else it is restricted to ±50MHz. The uncertainty is the RSS of ConvF uncertainty at calibration frequency and the uncertainty for the indicated frequency band. Frequency validity below 300 MHz is ± 10, 25, 40, 50 and 70 MHz for ConvF assessments at 30, 64, 128, 150 and 220 MHz respectively. Above 5 GHz frequency validity can be extended to ± 110 MHz.

<sup>F</sup> At frequency up to 6 GHz, the validity of tissue parameters ( $\epsilon$  and  $\sigma$ ) can be relaxed to ±10% if liquid compensation formula is applied to measured SAR values. The uncertainty is the RSS of the ConvF uncertainty for indicated target tissue parameters.

<sup>G</sup> Alpha/Depth are determined during calibration. SPEAG warrants that the remaining deviation due to the boundary effect after compensation is always less than ± 1% for frequencies below 3 GHz and below ± 2% for the frequencies between 3-6 GHz at any distance larger than half the probe tip diameter from the boundary.



Add: No.52 HuaYuanBei Road, Haidian District, Beijing, 100191, China  
Tel: +86-10-62304633-2117  
E-mail: emf@caict.ac.cn http://www.caict.ac.cn

### Frequency Response of E-Field (TEM-Cell: ifi110 EXX, Waveguide: R22)

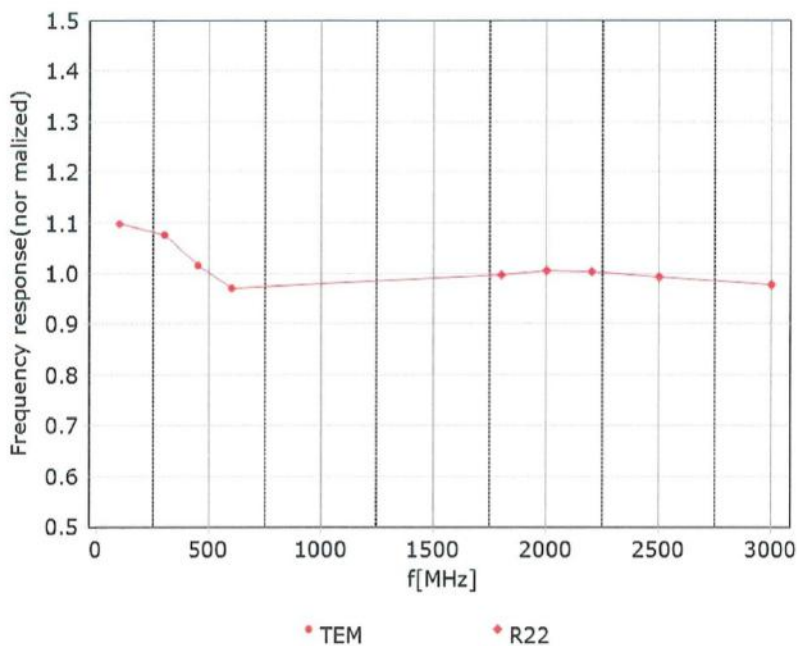

Uncertainty of Frequency Response of E-field:  $\pm 7.4\%$  ( $k=2$ )





Add: No.52 HuaYuanBei Road, Haidian District, Beijing, 100191, China  
 Tel: +86-10-62304633-2117  
 E-mail: emf@caict.ac.cn http://www.caict.ac.cn

### Receiving Pattern ( $\Phi$ ), $\theta=0^\circ$

**f=600 MHz, TEM**

**f=1800 MHz, R22**

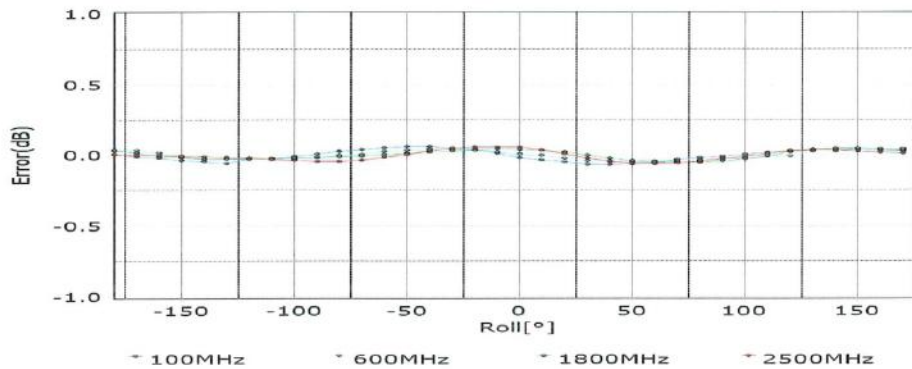
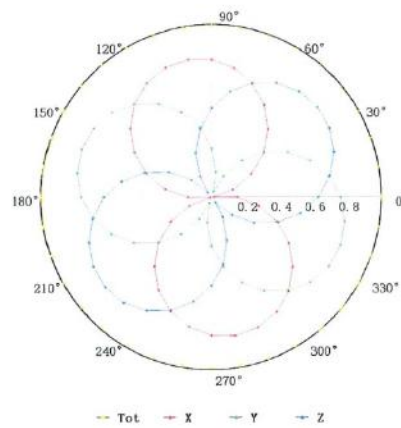
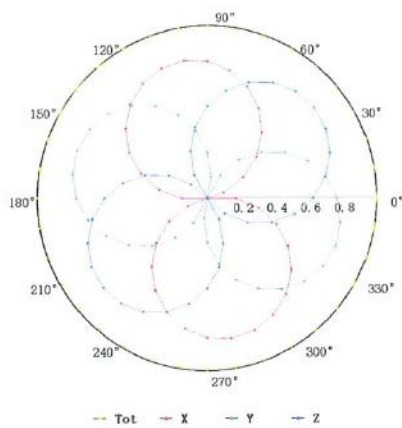

Uncertainty of Axial Isotropy Assessment:  $\pm 1.2\%$  ( $k=2$ )





Add: No.52 HuaYuanBei Road, Haidian District, Beijing, 100191, China  
 Tel: +86-10-62304633-2117  
 E-mail: emf@caict.ac.cn http://www.caict.ac.cn

### Dynamic Range f(SAR<sub>head</sub>) (TEM cell, f = 900 MHz)

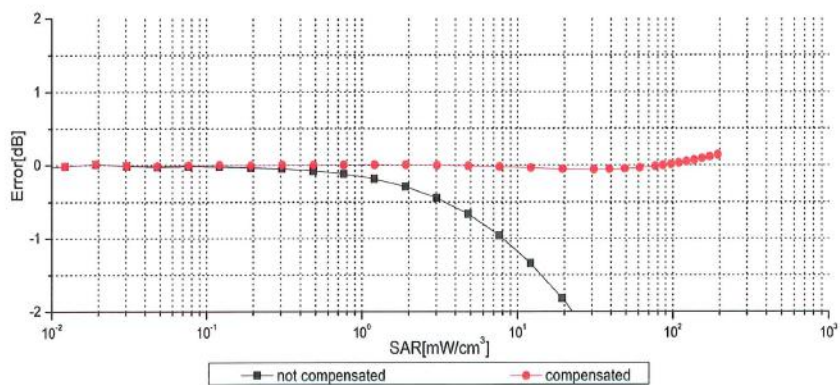
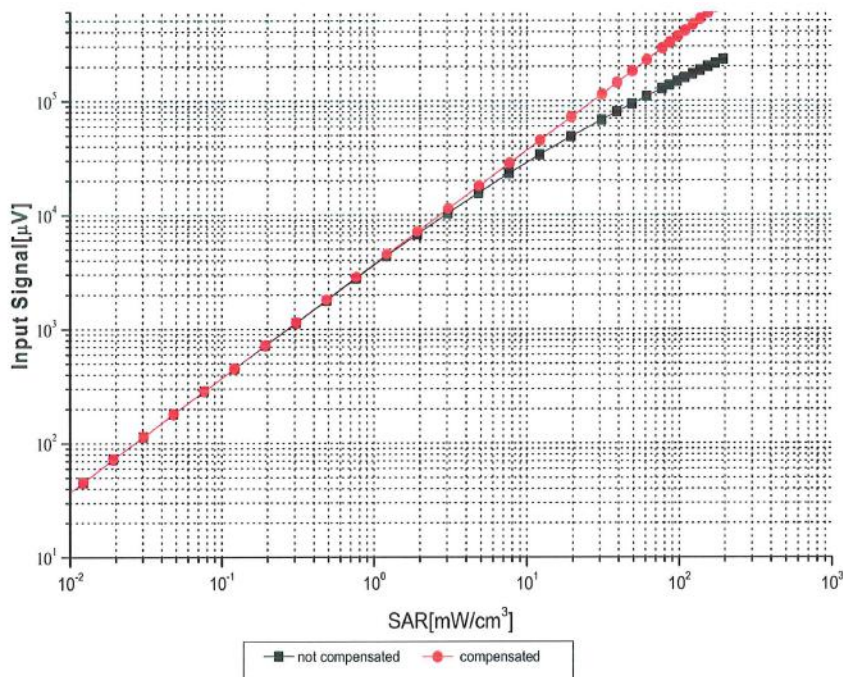

Uncertainty of Linearity Assessment: ±0.9% (k=2)



Add: No.52 HuaYuanBei Road, Haidian District, Beijing, 100191, China  
Tel: +86-10-62304633-2117  
E-mail: emf@caict.ac.cn http://www.caict.ac.cn

### Conversion Factor Assessment

f=750 MHz,WGLS R9(H\_convF)

f=1750 MHz,WGLS R22(H\_convF)

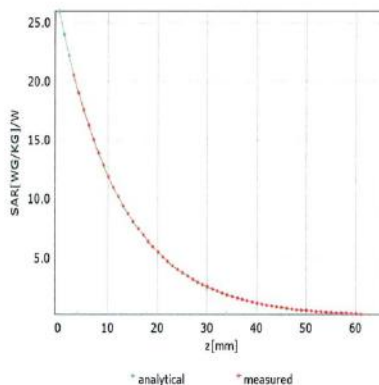
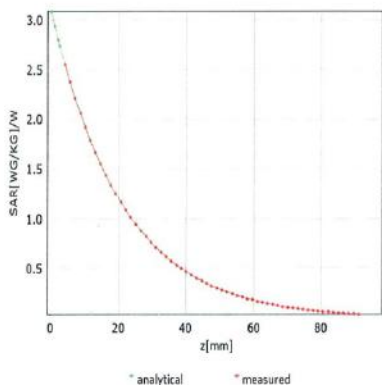

### Deviation from Isotropy in Liquid

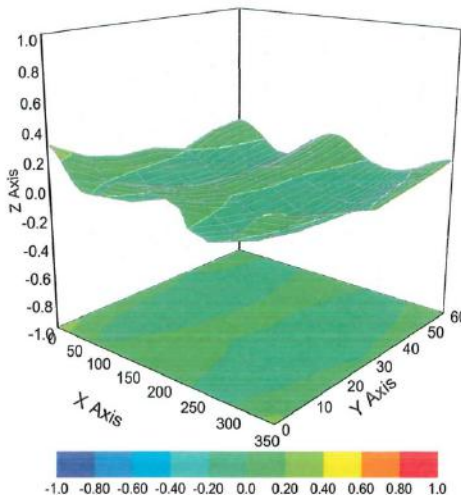

Uncertainty of Spherical Isotropy Assessment: ±3.2% (k=2)



Add: No.52 HuaYuanBei Road, Haidian District, Beijing, 100191, China  
 Tel: +86-10-62304633-2117  
 E-mail: emf@caict.ac.cn      http://www.caict.ac.cn

**DASY/EASY – Parameters of Probe: EX3DV4 – SN:7382**

**Other Probe Parameters**

<b>Sensor Arrangement</b>	<b>Triangular</b>
<b>Connector Angle (°)</b>	<b>65.4</b>
<b>Mechanical Surface Detection Mode</b>	<b>enabled</b>
<b>Optical Surface Detection Mode</b>	<b>disable</b>
<b>Probe Overall Length</b>	<b>337mm</b>
<b>Probe Body Diameter</b>	<b>10mm</b>
<b>Tip Length</b>	<b>9mm</b>
<b>Tip Diameter</b>	<b>2.5mm</b>
<b>Probe Tip to Sensor X Calibration Point</b>	<b>1mm</b>
<b>Probe Tip to Sensor Y Calibration Point</b>	<b>1mm</b>
<b>Probe Tip to Sensor Z Calibration Point</b>	<b>1mm</b>
<b>Recommended Measurement Distance from Surface</b>	<b>1.4mm</b>

# APPENDIX D DIPOLE CALIBRATION CERTIFICATES



中国认可  
国际互认  
校准  
CALIBRATION  
CNAS L0570



Add: No.52 HuaYuanBei Road, Haidian District, Beijing, 100191  
Tel: +86-10-62304633-2117  
E-mail: emf@caict.ac.cn http://www.caict.ac.cn

Client **BACL**

Certificate No: **Z23-60084**

CALIBRATION CERTIFICATE			
Object	D1900V2 - SN: 5d231		
Calibration Procedure(s)	FF-Z11-003-01 Calibration Procedures for dipole validation kits		
Calibration date:	February 17, 2023		
<p>This calibration Certificate documents the traceability to national standards, which realize the physical units of measurements (SI). The measurements and the uncertainties with confidence probability are given on the following pages and are part of the certificate.</p> <p>All calibrations have been conducted in the closed laboratory facility: environment temperature (22±3)°C and humidity&lt;70%.</p> <p>Calibration Equipment used (M&amp;TE critical for calibration)</p>			
Primary Standards	ID #	Cal Date (Calibrated by, Certificate No.)	Scheduled Calibration
Power Meter NRP2	106276	10-May-22 (CTTL, No.J22X03103)	May-23
Power sensor NRP6A	101369	10-May-22 (CTTL, No.J22X03103)	May-23
Reference Probe EX3DV4	SN 7464	19-Jan-23 (CTTL-SPEAG, No.Z22-60565)	Jan-24
DAE4	SN 1556	11-Jan-23(CTTL-SPEAG, No.Z23-60034)	Jan-24
Secondary Standards	ID #	Cal Date (Calibrated by, Certificate No.)	Scheduled Calibration
Signal Generator E4438C	MY49070393	17-May-23 (CTTL, No.J22X03157)	May-24
NetworkAnalyzer E5071C	MY46110673	10-Jan-23 (CTTL, No. J23X00104)	Jan-24
Calibrated by:	Name Zhao Jing	Function SAR Test Engineer	Signature 
Reviewed by:	Name Lin Hao	Function SAR Test Engineer	Signature 
Approved by:	Name Qi Dianyuan	Function SAR Project Leader	Signature 
Issued: February 24, 2023			
This calibration certificate shall not be reproduced except in full without written approval of the laboratory.			





Add: No.52 HuaYuanBei Road, Haidian District, Beijing, 100191, China  
 Tel: +86-10-62304633-2117  
 E-mail: cttl@chinattl.com <http://www.caict.ac.cn>

#### Glossary:

TSL	tissue simulating liquid
ConvF	sensitivity in TSL / NORM <sub>x,y,z</sub>
N/A	not applicable or not measured

#### Calibration is Performed According to the Following Standards:

- IEC/IEEE 62209-1528, "Measurement Procedure for The Assessment of Specific Absorption Rate of Human Exposure to Radio Frequency Fields from Hand-held and Body-mounted Wireless Communication Devices- Part 1528: Human Models, Instrumentation and Procedures (Frequency range of 4 MHz to 10 GHz)", October 2020
- KDB 865664, "SAR Measurement Requirements for 100 MHz to 6 GHz"

#### Additional Documentation:

- DASY4/5 System Handbook

#### Methods Applied and Interpretation of Parameters:

- Measurement Conditions:** Further details are available from the Validation Report at the end of the certificate. All figures stated in the certificate are valid at the frequency indicated.
- Antenna Parameters with TSL:** The dipole is mounted with the spacer to position its feed point exactly below the center marking of the flat phantom section, with the arms oriented parallel to the body axis.
- Feed Point Impedance and Return Loss:** These parameters are measured with the dipole positioned under the liquid filled phantom. The impedance stated is transformed from the measurement at the SMA connector to the feed point. The Return Loss ensures low reflected power. No uncertainty required.
- Electrical Delay:** One-way delay between the SMA connector and the antenna feed point. No uncertainty required.
- SAR measured:** SAR measured at the stated antenna input power.
- SAR normalized:** SAR as measured, normalized to an input power of 1 W at the antenna connector.
- SAR for nominal TSL parameters:** The measured TSL parameters are used to calculate the nominal SAR result.

The reported uncertainty of measurement is stated as the standard uncertainty of Measurement multiplied by the coverage factor  $k=2$ , which for a normal distribution corresponds to a coverage probability of approximately 95%.



Add: No.52 HuaYuanBei Road, Haidian District, Beijing, 100191, China  
 Tel: +86-10-62304633-2117  
 E-mail: cttl@chinattl.com http://www.caict.ac.cn

**Measurement Conditions**

DASY system configuration, as far as not given on page 1.

DASY Version	DASY52	52.10.4
Extrapolation	Advanced Extrapolation	
Phantom	Triple Flat Phantom 5.1C	
Distance Dipole Center - TSL	10 mm	with Spacer
Zoom Scan Resolution	dx, dy, dz = 5 mm	
Frequency	1900 MHz ± 1 MHz	

**Head TSL parameters**

The following parameters and calculations were applied.

	Temperature	Permittivity	Conductivity
Nominal Head TSL parameters	22.0 °C	40.0	1.40 mho/m
Measured Head TSL parameters	(22.0 ± 0.2) °C	39.0 ± 6 %	1.39 mho/m ± 6 %
Head TSL temperature change during test	<1.0 °C	---	---

**SAR result with Head TSL**

SAR averaged over 1 cm <sup>3</sup> (1 g) of Head TSL	Condition	
SAR measured	250 mW input power	10.0 W/kg
SAR for nominal Head TSL parameters	normalized to 1W	39.9 W/kg ± 18.8 % (k=2)
SAR averaged over 10 cm <sup>3</sup> (10 g) of Head TSL	Condition	
SAR measured	250 mW input power	5.21 W/kg
SAR for nominal Head TSL parameters	normalized to 1W	20.8 W/kg ± 18.7 % (k=2)



Add: No.52 HuaYuanBei Road, Haidian District, Beijing, 100191, China  
 Tel: +86-10-62304633-2117  
 E-mail: cttl@chinattl.com      http://www.caict.ac.cn

**Appendix (Additional assessments outside the scope of CNAS L0570)**

**Antenna Parameters with Head TSL**

Impedance, transformed to feed point	50.3Ω+ 4.99jΩ
Return Loss	- 26.1dB

**General Antenna Parameters and Design**

Electrical Delay (one direction)	1.105 ns
----------------------------------	----------

After long term use with 100W radiated power, only a slight warming of the dipole near the feed-point can be measured.

The dipole is made of standard semirigid coaxial cable. The center conductor of the feeding line is directly connected to the second arm of the dipole. The antenna is therefore short-circuited for DC-signals. On some of the dipoles, small end caps are added to the dipole arms in order to improve matching when loaded according to the position as explained in the "Measurement Conditions" paragraph. The SAR data are not affected by this change. The overall dipole length is still according to the Standard. No excessive force must be applied to the dipole arms, because they might bend or the soldered connections near the feed-point may be damaged.

**Additional EUT Data**

Manufactured by	SPEAG
-----------------	-------



Add: No.52 HuaYuanBei Road, Haidian District, Beijing, 100191, China  
 Tel: +86-10-62304633-2117  
 E-mail: cttl@chinattl.com http://www.caict.ac.cn

**DASY5 Validation Report for Head TSL**

Date: 2023-02-17

Test Laboratory: CTTL, Beijing, China

**DUT: Dipole 1900 MHz; Type: D1900V2; Serial: D1900V2 - SN: 5d231**

Communication System: UID 0, CW; Frequency: 1900 MHz

Medium parameters used:  $f = 1900 \text{ MHz}$ ;  $\sigma = 1.393 \text{ S/m}$ ;  $\epsilon_r = 38.96$ ;  $\rho = 1000 \text{ kg/m}^3$

Phantom section: Right Section

Measurement Standard: DASY5 (IEEE/IEC/ANSI C63.19-2007)

**DASY5 Configuration:**

- Probe: EX3DV4 - SN7464; ConvF(8.13, 8.13, 8.13) @ 1900 MHz; Calibrated: 2023-01-19
- Sensor-Surface: 1.4mm (Mechanical Surface Detection)
- Electronics: DAE4 Sn1556; Calibrated: 2023-01-11
- Phantom: MFP\_V5.1C (20deg probe tilt); Type: QD 000 P51 Cx; Serial: 1062
- DASY52 52.10.4(1535); SEMCAD X 14.6.14(7501)

**Dipole Calibration/Zoom Scan (7x7x7) (7x7x7)/Cube 0:** Measurement grid:  $dx=5\text{mm}$ ,  $dy=5\text{mm}$ ,  $dz=5\text{mm}$

Reference Value = 100.8 V/m; Power Drift = -0.04 dB

Peak SAR (extrapolated) = 18.9 W/kg

SAR(1 g) = 10 W/kg; SAR(10 g) = 5.21 W/kg

Smallest distance from peaks to all points 3 dB below = 10 mm

Ratio of SAR at M2 to SAR at M1 = 53.6%

Maximum value of SAR (measured) = 15.7 W/kg

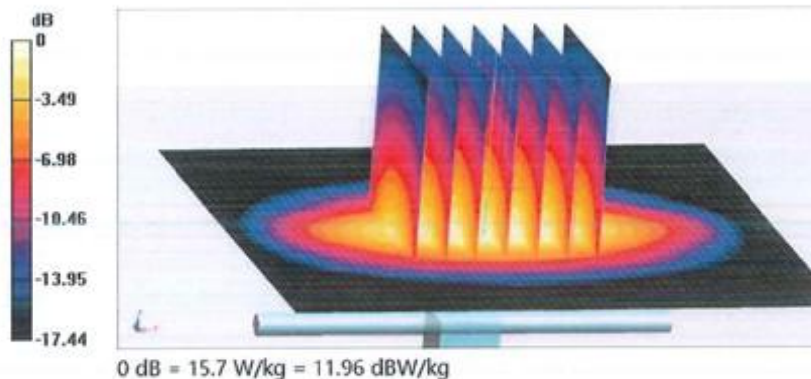





Add: No.52 HuaYuanBei Road, Haidian District, Beijing, 100191, China  
Tel: +86-10-62304633-2117  
E-mail: cttl@chinattl.com http://www.caict.ac.cn

**Impedance Measurement Plot for Head TSL**

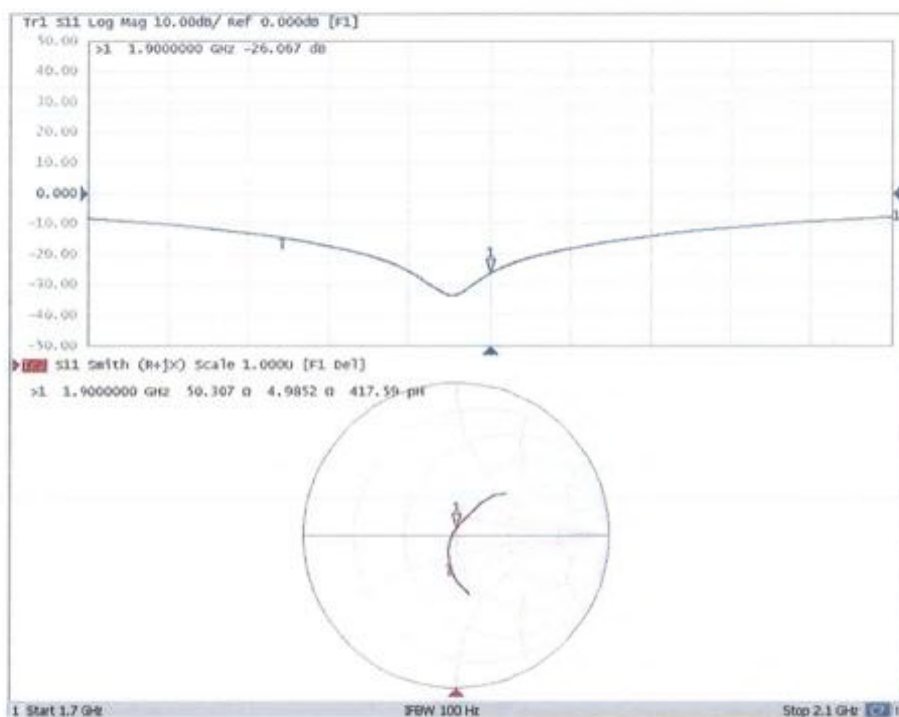

## APPENDIX E RETURN LOSS&IMPEDANCE MEASUREMENT

### Equipment Details:

Description: Dipole  
 Manufacturer: Speag  
 Model Number: D1900V2  
 Serial Number: 5d231  
 Calibration Date: 2024/02/01  
 Calibrated By: Sid Luo  
 Signature: *Sid Luo*

All Calibration have been conducted in the closed laboratory facility: Lab Temperature 18°C-25°C and humidity <70%

### The calibration methods and procedures used were as detailed in:

FCC KDB Publication Number: “KDB865664 D01 SAR Measurement 100 MHz to 6 GHz”

1. The return-loss does not deviate more than 20% from the previous measurement and meets the required 20dB minimum return-loss requirement.
2. The measurement of real or imaginary parts of impedance does not deviate more than 5Ω from the previous measurement.

### Calibrated Equipment:

Equipment	Model	S/N	Calibration Date	Calibration Due Date
Simulated Tissue Liquid Head	HBBL600-10000V6	2200808-2	Each Time	
SAM Twin Phantom	SAM-Twin V8.0	1962	NCR	NCR
Network Analyzer	E5071C	SER MY46519680	2023/06/08	2024/06/07
Network Analyzer Calibration Kit	50Ω	51026	NCR	NCR

### Test Data:

Frequency (MHz)	Simulated Liquid	Parameter	Measured Value	Target Value	Deviation	Reference Range	Results
1900	Head	Return Loss	27.268 dB	26.067dB	4.607 %	±20%;≤20dB	Pass
		Real Impedance	52.799 Ω	50.307 Ω	2.492 Ω	≤5Ω	Pass
		Imaginary Impedance	3.453 Ω	4.985 Ω	-1.532 Ω	≤5Ω	Pass

Note: Return LossDeviation = (Measured-Target)/Target×100%

### Dipole, 1900MHz, 5d231

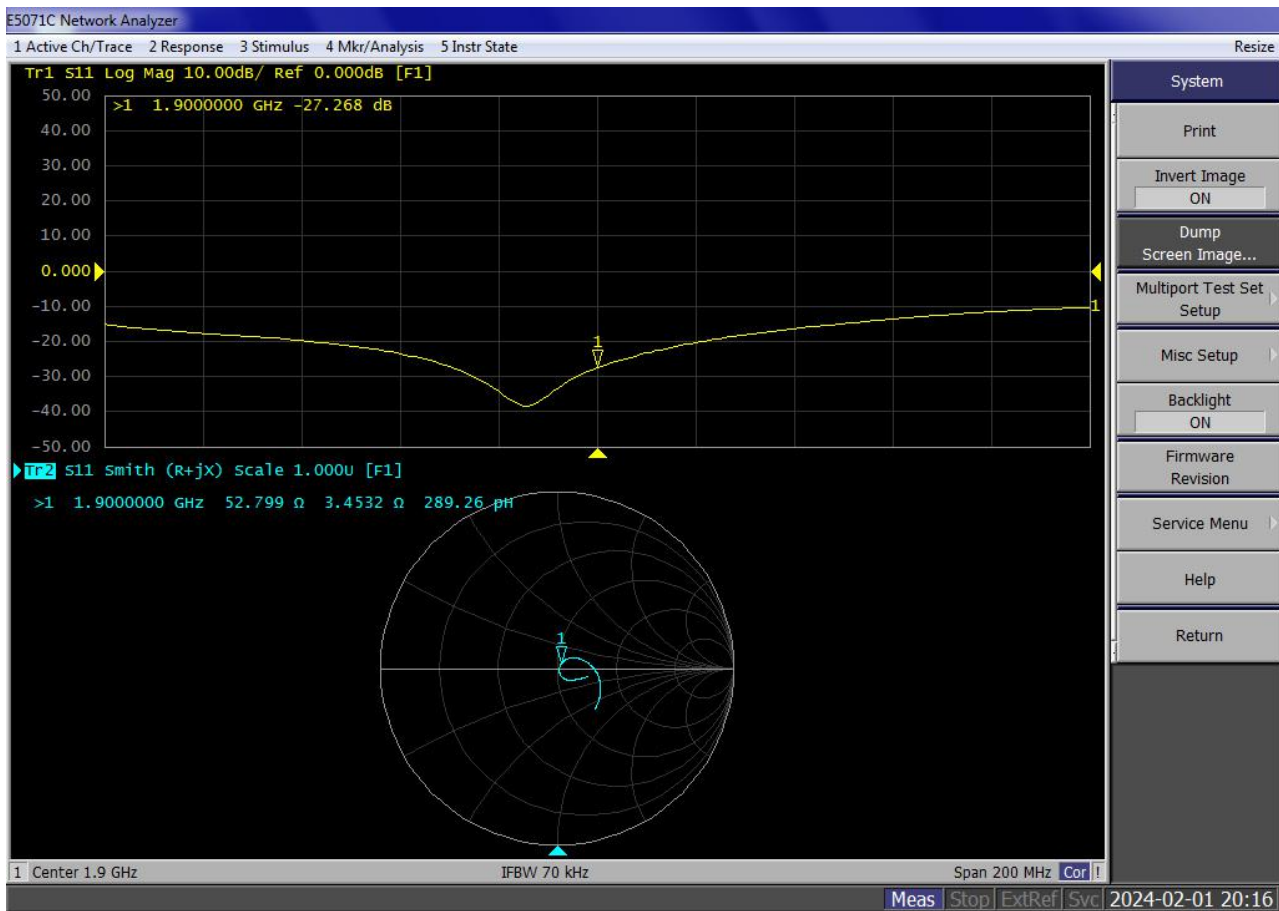

\*\*\*\*\* END OF REPORT \*\*\*\*\*