

# FCC Test Report

**Applicant** : **Shenzhen Blue Shark Technology Co., Ltd.**

**Address** : **A603, Yaxiang Centennial Jia Building,  
Shangxue Science and Technology Park,  
Bantian Street, Longgang District, Shenzhen,  
China**

**Product Name** : **player**

**Report Date** : **Apr. 24, 2024**



**Shenzhen Anbotek Compliance Laboratory Limited**

**Shenzhen Anbotek Compliance Laboratory Limited**

Address: 1/F., Building D, Sogood Science and Technology Park, Sanwei Community,  
Hangcheng Street, Bao'an District, Shenzhen, Guangdong, China.  
Tel: (86)0755-26066440 Fax: (86)0755-26014772 Email: service@anbotek.com



Hotline  
400-003-0500  
www.anbotek.com.cn



# Contents

1. General Information .....	6
1.1. Client Information .....	6
1.2. Description of Device (EUT) .....	6
1.3. Auxiliary Equipment Used During Test .....	7
1.4. Operation channel list .....	8
1.5. Description of Test Modes .....	9
1.6. Measurement Uncertainty .....	9
1.7. Test Summary .....	10
1.8. Description of Test Facility .....	11
1.9. Disclaimer .....	11
1.10. Test Equipment List .....	12
2. Antenna requirement .....	14
2.1. Conclusion .....	14
3. Conducted Emission at AC power line .....	15
3.1. EUT Operation .....	15
3.2. Test Setup .....	15
3.3. Test Data .....	16
4. Occupied Bandwidth .....	18
4.1. EUT Operation .....	18
4.2. Test Setup .....	19
4.3. Test Data .....	19
5. Maximum Conducted Output Power .....	20
5.1. EUT Operation .....	20
5.2. Test Setup .....	21
5.3. Test Data .....	21
6. Channel Separation .....	22
6.1. EUT Operation .....	22
6.2. Test Setup .....	22
6.3. Test Data .....	22
7. Number of Hopping Frequencies .....	23
7.1. EUT Operation .....	23
7.2. Test Setup .....	23
7.3. Test Data .....	24
8. Dwell Time .....	25
8.1. EUT Operation .....	26
8.2. Test Setup .....	26
8.3. Test Data .....	26
9. Emissions in non-restricted frequency bands .....	27
9.1. EUT Operation .....	28
9.2. Test Setup .....	28
9.3. Test Data .....	28

**Shenzhen Anbotek Compliance Laboratory Limited**

Address: 1/F., Building D, Sogood Science and Technology Park, Sanwei Community,  
Hangcheng Street, Bao'an District, Shenzhen, Guangdong, China.  
Tel: (86)0755-26066440 Fax: (86)0755-26014772 Email: service@anbotek.com



Hotline  
400-003-0500  
www.anbotek.com.cn



- 10. Band edge emissions (Radiated)..... 29
  - 10.1. EUT Operation ..... 29
  - 10.2. Test Setup ..... 30
  - 10.3. Test Data ..... 31
- 11. Emissions in frequency bands (below 1GHz) ..... 32
  - 11.1. EUT Operation ..... 32
  - 11.2. Test Setup ..... 33
  - 11.3. Test Data ..... 34
- 12. Emissions in frequency bands (above 1GHz) ..... 36
  - 12.1. EUT Operation ..... 36
  - 12.2. Test Setup ..... 37
  - 12.3. Test Data ..... 38
- APPENDIX I -- TEST SETUP PHOTOGRAPH ..... 41
- APPENDIX II -- EXTERNAL PHOTOGRAPH ..... 41
- APPENDIX III -- INTERNAL PHOTOGRAPH ..... 41



Report No.: 18220WC40059901

FCC ID: 2BFNB-G15

Page 4 of 41

# TEST REPORT

Applicant : Shenzhen Blue Shark Technology Co., Ltd.

Manufacturer : Shenzhen Blue Shark Technology Co., Ltd.

Product Name : player

Test Model No. : G15

Reference Model No. : Please refer to page 6

Trade Mark : N/A

Rating(s) : Input: 5V $\overline{=}$  2A  
Battery Capacity: DC 3.7V, 2500mAh**Test Standard(s) : ANSI C63.10-2020  
KDB 558074 D01 15.247 Meas Guidance v05r02**

The device described above is tested by Shenzhen Anbotek Compliance Laboratory Limited to determine the maximum emission levels emanating from the device and the severe levels of the device can endure and its performance criterion. The measurement results are contained in this test report and Shenzhen Anbotek Compliance Laboratory Limited is assumed full of responsibility for the accuracy and completeness of these measurements. Also, this report shows that the EUT (Equipment Under Test) is technically compliant with above listed standard(s) requirements. This report applies to above tested sample only and shall not be reproduced in part without written approval of Shenzhen Anbotek Compliance Laboratory Limited.

Date of Receipt: Mar. 27, 2024

Date of Test: Mar. 27, 2024 to Apr. 20, 2024

Prepared By:



(Ella Liang)

Approved &amp; Authorized Signer:



(Edward Pan)

## Shenzhen Anbotek Compliance Laboratory Limited

Address: 1/F., Building D, Sogood Science and Technology Park, Sanwei Community,  
Hangcheng Street, Bao'an District, Shenzhen, Guangdong, China.  
Tel: (86)0755-26066440 Fax: (86)0755-26014772 Email: service@anbotek.com



Hotline  
400-003-0500  
www.anbotek.com.cn



**Revision History**

Report Version	Description	Issued Date
R00	Original Issue.	Apr. 24, 2024

**Shenzhen Anbotek Compliance Laboratory Limited**

Address: 1/F., Building D, Sogood Science and Technology Park, Sanwei Community, Hangcheng Street, Bao'an District, Shenzhen, Guangdong, China.  
Tel: (86)0755-26066440 Fax: (86)0755-26014772 Email: service@anbotek.com



Hotline  
400-003-0500  
www.anbotek.com.cn



## 1. General Information

### 1.1. Client Information

Applicant	:	Shenzhen Blue Shark Technology Co., Ltd.
Address	:	A603, Yaxiang Centennial Jia Building, Shangxue Science and Technology Park, Bantian Street, Longgang District, Shenzhen, China
Manufacturer	:	Shenzhen Blue Shark Technology Co., Ltd.
Address	:	A603, Yaxiang Centennial Jia Building, Shangxue Science and Technology Park, Bantian Street, Longgang District, Shenzhen, China
Factory	:	Shenzhen Blue Shark Technology Co., Ltd.
Address	:	A603, Yaxiang Centennial Jia Building, Shangxue Science and Technology Park, Bantian Street, Longgang District, Shenzhen, China

### 1.2. Description of Device (EUT)

Product Name	:	player
Test Model No.	:	G15
Reference Model No.	:	G10, G12, G16, G18, G20, M1, M2, M3, M4, M5, M5B, M6, M7, M8A, M8B, M9, M9A, M9B, M10, M11, M12, M13, M24, M28, M30, M301, M302, M32, M39, M40, M43, M47, M471, M50, M60, A30, W1, W2, W3, W4, W5, W6, W7, W8, W9, W10, W11, W12, W13, W14, W15, W16, W17, W18, W19, W20, A1, A2, A3, A4, A5, A6, A7, A8, A9, A10, A11, A12, A13, A14, A15, A16, A17, A18, 19, A20, B1, B2, B3, B4, B5, B6, B7, B8, B9, B10, B11, B12, B13, B14, B15, B16, B17, B18, B19, B20, Q1, Q2, Q3, Q4, Q5, Q6, Q7, Q8, Q9, Q10, Q11, Q12, Q13, Q14, Q15, Q16, Q17, Q18, Q19, Q20, H1, H2, H3, H4, H5, H6, H7, H8, H9, H10, H11, H12, H13, H14, H15, H16, H17, H18, H19, H20, K1, K2, K3, K4, K5, K6, K7, K8, K9, K10, K11, K12, K13, K14, K15, K16, K17, K18, K19, K20, S1, S2, S3, S4, S5, S6, S7, S8, S9, S10, S11, S12, S13, S14, S15, S16, S17, S18, S19, S20 (Note: All samples are the same except the model number and appearance color, so we prepare "G15" for test only.)
Trade Mark	:	N/A
Test Power Supply	:	DC 5V from adapter input AC 120V/60Hz; DC 3.7V battery inside
Test Sample No.	:	1-2-1(Normal Sample), 1-2-2(Engineering Sample)
Adapter	:	N/A
<b>RF Specification</b>		
Operation Frequency	:	2402MHz to 2480MHz
Number of Channel	:	79
Modulation Type	:	GFSK, $\pi/4$ DQPSK, 8DPSK
Antenna Type	:	FPC Antenna
Antenna Gain(Peak)	:	-2.62dBi
<b>Remark:</b>		
(1) All of the RF specification are provided by customer.		
(2) For a more detailed features description, please refer to the manufacturer's specifications or the User's Manual.		

#### Shenzhen Anbotek Compliance Laboratory Limited

Address: 1/F., Building D, Sogood Science and Technology Park, Sanwei Community, Hangcheng Street, Bao'an District, Shenzhen, Guangdong, China.  
Tel: (86)0755-26066440 Fax: (86)0755-26014772 Email: service@anbotek.com



Hotline  
400-003-0500  
www.anbotek.com.cn



**1.3. Auxiliary Equipment Used During Test**

Title	Manufacturer	Model No.	Serial No.
Xiaomi 33W adapter	Xiaomi	MDY-11-EX	SA62212LA04358J

**Shenzhen Anbotek Compliance Laboratory Limited**

Address: 1/F., Building D, Sogood Science and Technology Park, Sanwei Community, Hangcheng Street, Bao'an District, Shenzhen, Guangdong, China.  
Tel: (86)0755-26066440 Fax: (86)0755-26014772 Email: service@anbotek.com



Hotline  
400-003-0500  
www.anbotek.com.cn



#### 1.4. Operation channel list

Operation Band:

Channel	Frequency (MHz)	Channel	Frequency (MHz)	Channel	Frequency (MHz)	Channel	Frequency (MHz)
0	2402	20	2422	40	2442	60	2462
1	2403	21	2423	41	2443	61	2463
2	2404	22	2424	42	2444	62	2464
3	2405	23	2425	43	2445	63	2465
4	2406	24	2426	44	2446	64	2466
5	2407	25	2427	45	2447	65	2467
6	2408	26	2428	46	2448	66	2468
7	2409	27	2429	47	2449	67	2469
8	2410	28	2430	48	2450	68	2470
9	2411	29	2431	49	2451	69	2471
10	2412	30	2432	50	2452	70	2472
11	2413	31	2433	51	2453	71	2473
12	2414	32	2434	52	2454	72	2474
13	2415	33	2435	53	2455	73	2475
14	2416	34	2436	54	2456	74	2476
15	2417	35	2437	55	2457	75	2477
16	2418	36	2438	56	2458	76	2478
17	2419	37	2439	57	2459	77	2479
18	2420	38	2440	58	2460	78	2480
19	2421	39	2441	59	2461	-	-

#### Shenzhen Anbotek Compliance Laboratory Limited

Address: 1/F., Building D, Sogood Science and Technology Park, Sanwei Community, Hangcheng Street, Bao'an District, Shenzhen, Guangdong, China.  
Tel: (86)0755-26066440 Fax: (86)0755-26014772 Email: service@anbotek.com



Hotline  
400-003-0500  
www.anbotek.com.cn





## 1.5. Description of Test Modes

Pretest Modes	Descriptions
TM1	Keep the EUT in continuously transmitting mode (non-hopping) with GFSK modulation.
TM2	Keep the EUT in continuously transmitting mode (non-hopping) with $\pi/4$ DQPSK modulation.
TM3	Keep the EUT in continuously transmitting mode (non-hopping) with 8DPSK modulation.
TM4	Keep the EUT in continuously transmitting mode (hopping) with GFSK modulation,.
TM5	Keep the EUT in continuously transmitting mode (hopping) with $\pi/4$ DQPSK modulation.
TM6	Keep the EUT in continuously transmitting mode (hopping) with 8DPSK modulation.

## 1.6. Measurement Uncertainty

Parameter	Uncertainty
Conducted emissions (AMN 150kHz~30MHz)	3.4dB
Occupied Bandwidth	925Hz
Conducted Output Power	0.76dB
Conducted Spurious Emission	1.24dB
Radiated spurious emissions (above 1GHz)	1G-6GHz: 4.78dB; 6G-18GHz: 4.88dB 18G-40GHz: 5.68dB
Radiated emissions (Below 30MHz)	3.53dB
Radiated spurious emissions (30MHz~1GHz)	Horizontal: 3.92dB; Vertical: 4.52dB
The measurement uncertainty and decision risk evaluated according to AB/WI-RF-F-032. This uncertainty represents an expanded uncertainty expressed at approximately the 95% confidence level using a coverage factor of k=2.	

### Shenzhen Anbotek Compliance Laboratory Limited

Address: 1/F., Building D, Sogood Science and Technology Park, Sanwei Community, Hangcheng Street, Bao'an District, Shenzhen, Guangdong, China.  
Tel: (86)0755-26066440 Fax: (86)0755-26014772 Email: service@anbotek.com



Hotline  
400-003-0500  
www.anbotek.com.cn



**1.7. Test Summary**

Test Items	Test Modes	Status
Antenna requirement	/	P
Conducted Emission at AC power line	Mode1,2,3	P
Occupied Bandwidth	Mode1,2,3	P
Maximum Conducted Output Power	Mode1,2,3	P
Channel Separation	Mode4,5,6	P
Number of Hopping Frequencies	Mode4,5,6	P
Dwell Time	Mode4,5,6	P
Emissions in non-restricted frequency bands	Mode1,2,3,4,5,6	P
Band edge emissions (Radiated)	Mode1,2,3	P
Emissions in frequency bands (below 1GHz)	Mode1,2,3	P
Emissions in frequency bands (above 1GHz)	Mode1,2,3	P
Note: P: Pass N: N/A, not applicable		

**Shenzhen Anbotek Compliance Laboratory Limited**

Address: 1/F., Building D, Sogood Science and Technology Park, Sanwei Community,  
Hangcheng Street, Bao'an District, Shenzhen, Guangdong, China.  
Tel: (86)0755-26066440 Fax: (86)0755-26014772 Email: service@anbotek.com



Hotline  
400-003-0500  
www.anbotek.com.cn



## 1.8. Description of Test Facility

The test facility is recognized, certified, or accredited by the following organizations:

### FCC-Registration No.:434132

Shenzhen Anbotek Compliance Laboratory Limited, EMC Laboratory has been registered and fully described in a report filed with the (FCC) Federal Communications Commission. The acceptance letter from the FCC is maintained in our files. Registration No. 434132.

### ISED-Registration No.: 8058A

Shenzhen Anbotek Compliance Laboratory Limited, EMC Laboratory has been registered and fully described in a report filed with the (ISED) Innovation, Science and Economic Development Canada. The acceptance letter from the ISED is maintained in our files. Registration 8058A.

### Test Location

Shenzhen Anbotek Compliance Laboratory Limited.

1/F, Building D, Sogood Science and Technology Park, Sanwei community, Hangcheng Street, Bao'an District, Shenzhen, Guangdong, China.

## 1.9. Disclaimer

1. The test report is invalid if not marked with the signatures of the persons responsible for preparing and approving the test report.
2. The test report is invalid if there is any evidence and/or falsification.
3. The results documented in this report apply only to the tested sample, under the conditions and modes of operation as described herein.
4. This document may not be altered or revised in any way unless done so by Anbotek and all revisions are duly noted in the revisions section.
5. Content of the test report, in part or in full, cannot be used for publicity and/or promotional purposes without prior written approval from the laboratory.
6. The authenticity of the information provided by the customer is the responsibility of the customer and the laboratory is not responsible for its authenticity.

The laboratory is only responsible for the data released by the laboratory, except for the part provided by the applicant.

### Shenzhen Anbotek Compliance Laboratory Limited

Address:1/F.,Building D,Sogood Science and Technology Park, Sanwei Community,  
Hangcheng Street, Bao'an District, Shenzhen, Guangdong, China.  
Tel:(86)0755-26066440 Fax:(86)0755-26014772 Email:service@anbotek.com



Hotline  
400-003-0500  
www.anbotek.com.cn



## 1.10. Test Equipment List

Conducted Emission at AC power line						
Item	Equipment	Manufacturer	Model No.	Serial No.	Last Cal.	Cal.Due Date
1	L.I.S.N. Artificial Mains Network	Rohde & Schwarz	ENV216	100055	2024-01-18	2025-01-17
2	Three Phase V-type Artificial Power Network	CYBERTEK	EM5040DT	E215040D T001	2024-01-17	2025-01-16
3	Software Name EZ-EMC	Farad Technology	ANB-03A	N/A	/	/
4	EMI Test Receiver	Rohde & Schwarz	ESPI3	100926	2023-10-12	2024-10-11

Maximum Conducted Output Power Channel Separation Number of Hopping Frequencies Dwell Time Emissions in non-restricted frequency bands Occupied Bandwidth						
Item	Equipment	Manufacturer	Model No.	Serial No.	Last Cal.	Cal.Due Date
1	Constant Temperature Humidity Chamber	ZHONGJIAN	ZJ-KHWS80B	N/A	2023-10-16	2024-10-15
2	DC Power Supply	IVYTECH	IV3605	1804D360 510	2023-10-20	2024-10-19
3	Spectrum Analyzer	Rohde & Schwarz	FSV40-N	101792	2023-05-26	2024-05-25
4	MXA Spectrum Analysis	KEYSIGHT	N9020A	MY505318 23	2023-10-12	2024-10-11
5	Oscilloscope	Tektronix	MDO3012	C020298	2023-10-12	2024-10-11
6	MXG RF Vector Signal Generator	Agilent	N5182A	MY474206 47	2024-02-04	2025-02-03

### Shenzhen Anbotek Compliance Laboratory Limited

Address: 1/F., Building D, Sogood Science and Technology Park, Sanwei Community, Hangcheng Street, Bao'an District, Shenzhen, Guangdong, China.  
Tel: (86)0755-26066440 Fax: (86)0755-26014772 Email: service@anbotek.com



Hotline  
400-003-0500  
www.anbotek.com.cn



Band edge emissions (Radiated) Emissions in frequency bands (above 1GHz)						
Item	Equipment	Manufacturer	Model No.	Serial No.	Last Cal.	Cal.Due Date
1	EMI Test Receiver	Rohde & Schwarz	ESR26	101481	2024-01-23	2025-01-22
2	EMI Preamplifier	SKET Electronic	LNPA-0118G-45	SKET-PA-002	2024-01-17	2025-01-16
3	Double Ridged Horn Antenna	SCHWARZBECK	BBHA 9120D	02555	2022-10-16	2025-10-15
4	EMI Test Software EZ-EMC	SHURPLE	N/A	N/A	/	/
5	Horn Antenna	A-INFO	LB-180400-KF	J211060628	2023-10-12	2024-10-11
6	Spectrum Analyzer	Rohde & Schwarz	FSV40-N	101792	2023-05-26	2024-05-25
7	Amplifier	Talent Microwave	TLLA18G40 G-50-30	23022802	2023-05-25	2024-05-24

Emissions in frequency bands (below 1GHz)						
Item	Equipment	Manufacturer	Model No.	Serial No.	Last Cal.	Cal.Due Date
1	EMI Test Receiver	Rohde & Schwarz	ESR26	101481	2024-01-23	2025-01-22
2	Pre-amplifier	SONOMA	310N	186860	2024-01-17	2025-01-16
3	Bilog Broadband Antenna	Schwarzbeck	VULB9163	345	2022-10-23	2025-10-22
4	Loop Antenna (9K-30M)	Schwarzbeck	FMZB1519 B	00053	2023-10-12	2024-10-11
5	EMI Test Software EZ-EMC	SHURPLE	N/A	N/A	/	/

**Shenzhen Anbotek Compliance Laboratory Limited**

Address: 1/F., Building D, Sogood Science and Technology Park, Sanwei Community, Hangcheng Street, Bao'an District, Shenzhen, Guangdong, China.  
 Tel: (86)0755-26066440 Fax: (86)0755-26014772 Email: service@anbotek.com

Hotline 400-003-0500  
 www.anbotek.com.cn



## 2. Antenna requirement

**Test Requirement:**

Refer to 47 CFR Part 15.203, an intentional radiator shall be designed to ensure that no antenna other than that furnished by the responsible party shall be used with the device. The use of a permanently attached antenna or of an antenna that uses a unique coupling to the intentional radiator shall be considered sufficient to comply with the provisions of this section.

### 2.1. Conclusion

The antenna is a FPC Antenna which permanently attached, and the best case gain of the antenna is -2.62dBi. It complies with the standard requirement.

**Shenzhen Anbotek Compliance Laboratory Limited**

Address: 1/F., Building D, Sogood Science and Technology Park, Sanwei Community, Hangcheng Street, Bao'an District, Shenzhen, Guangdong, China.  
Tel: (86)0755-26066440 Fax: (86)0755-26014772 Email: service@anbotek.com



Hotline  
400-003-0500  
www.anbotek.com.cn



### 3. Conducted Emission at AC power line

Test Requirement:	Refer to 47 CFR 15.207(a), Except as shown in paragraphs (b) and (c) of this section, for an intentional radiator that is designed to be connected to the public utility (AC) power line, the radio frequency voltage that is conducted back onto the AC power line on any frequency or frequencies, within the band 150 kHz to 30 MHz, shall not exceed the limits in the following table, as measured using a 50 $\mu$ H/50 ohms line impedance stabilization network (LISN).		
Test Limit:	Frequency of emission (MHz)	Conducted limit (dB $\mu$ V)	
		Quasi-peak	Average
	0.15-0.5	66 to 56*	56 to 46*
	0.5-5	56	46
	5-30	60	50
	*Decreases with the logarithm of the frequency.		
Test Method:	ANSI C63.10-2020 section 6.2		
Procedure:	Refer to ANSI C63.10-2020 section 6.2, standard test method for ac power-line conducted emissions from unlicensed wireless devices		

#### 3.1. EUT Operation

Operating Environment:	
Test mode:	<ol style="list-style-type: none"> <li>1: TX-GFSK (Non-Hopping): Keep the EUT in continuously transmitting mode (non-hopping) with GFSK modulation.</li> <li>2: TX-<math>\pi/4</math>-DQPSK (Non-Hopping): Keep the EUT in continuously transmitting mode (non-hopping) with <math>\pi/4</math> DQPSK modulation.</li> <li>3: TX-8DPSK (Non-Hopping): Keep the EUT in continuously transmitting mode (non-hopping) with 8DPSK modulation.</li> </ol>

#### 3.2. Test Setup

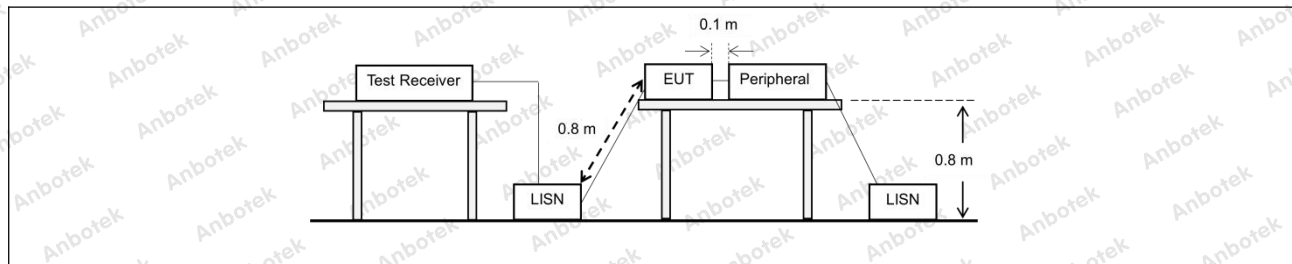

### 3.3. Test Data

Temperature:	23.2 °C	Humidity:	59 %	Atmospheric Pressure:	101 kPa
--------------	---------	-----------	------	-----------------------	---------

TM1 / Line: Line / Band: 2400-2483.5 MHz / BW: 1 / CH: L

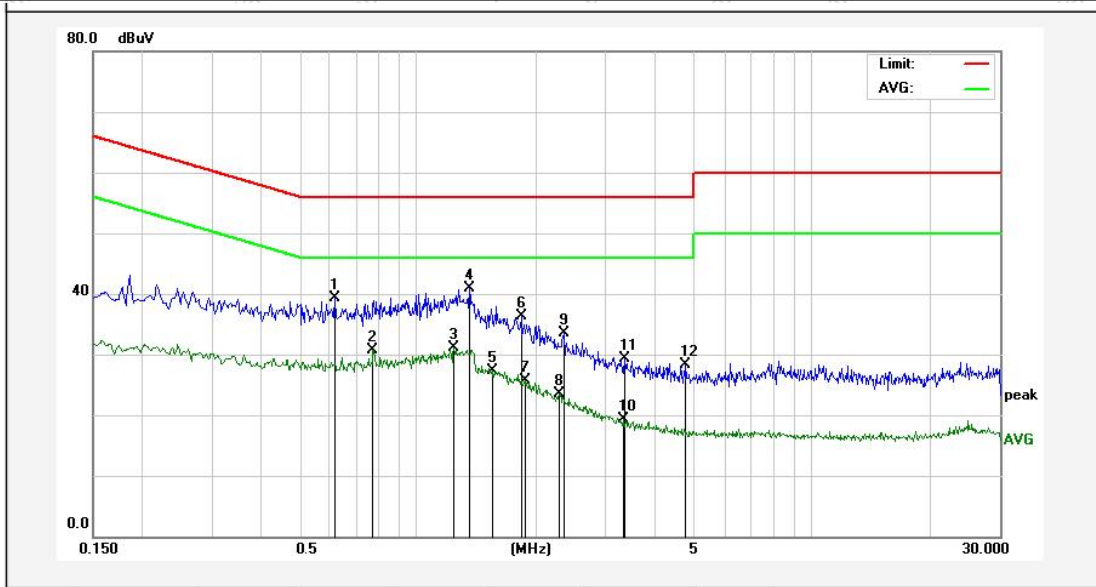

No.	Freq. (MHz)	Reading (dBuV)	Factor (dB)	Result (dBuV)	Limit (dBuV)	Over Limit (dB)	Detector	Remark
1	0.6180	21.46	17.86	39.32	56.00	-16.68	QP	
2	0.7740	12.87	17.87	30.74	46.00	-15.26	AVG	
3	1.2420	13.22	17.84	31.06	46.00	-14.94	AVG	
4	1.3580	23.13	17.84	40.97	56.00	-15.03	QP	
5	1.5540	9.42	17.84	27.26	46.00	-18.74	AVG	
6	1.8380	18.48	17.83	36.31	56.00	-19.69	QP	
7	1.8860	7.84	17.83	25.67	46.00	-20.33	AVG	
8	2.2860	5.63	17.83	23.46	46.00	-22.54	AVG	
9	2.3500	15.62	17.83	33.45	56.00	-22.55	QP	
10	3.3140	1.53	17.84	19.37	46.00	-26.63	AVG	
11	3.3620	11.42	17.84	29.26	56.00	-26.74	QP	
12	4.7740	10.40	17.85	28.25	56.00	-27.75	QP	





Temperature: 23.2 °C

Humidity: 59 %

Atmospheric Pressure: 101 kPa

TM1 / Line: Neutral / Band: 2400-2483.5 MHz / BW: 1 / CH: L

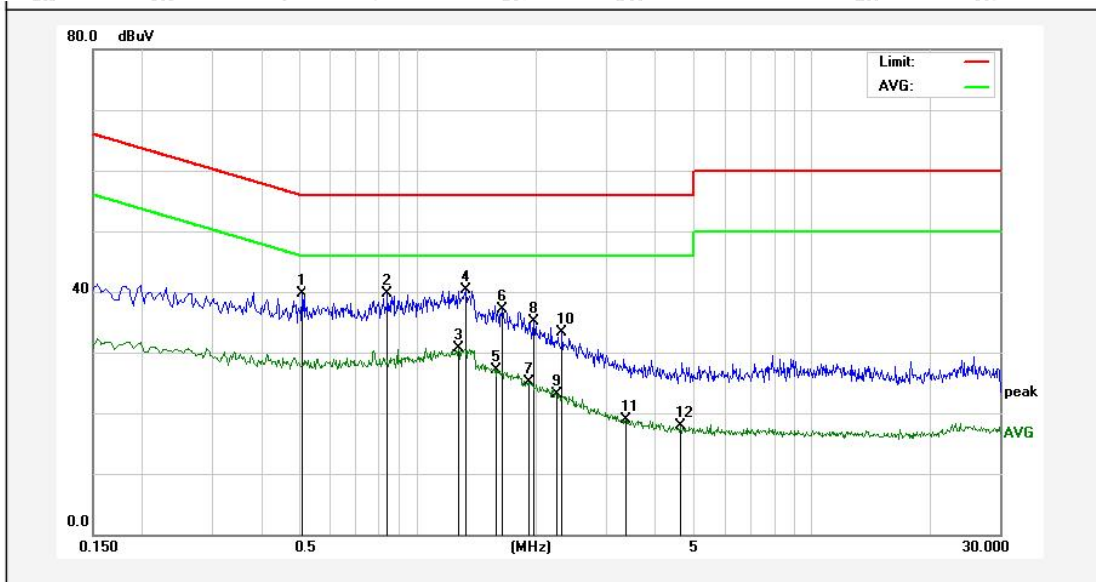

No.	Freq. (MHz)	Reading (dBuV)	Factor (dB)	Result (dBuV)	Limit (dBuV)	Over Limit (dB)	Detector	Remark
1	0.5100	21.81	17.85	39.66	56.00	-16.34	QP	
2	0.8420	21.78	17.86	39.64	56.00	-16.36	QP	
3	1.2740	12.95	17.84	30.79	46.00	-15.21	AVG	
4	1.3300	22.47	17.84	40.31	56.00	-15.69	QP	
5	1.5900	9.33	17.84	27.17	46.00	-18.83	AVG	
6	1.6420	19.27	17.84	37.11	56.00	-18.89	QP	
7	1.9140	7.23	17.83	25.06	46.00	-20.94	AVG	
8	1.9740	17.25	17.83	35.08	56.00	-20.92	QP	
9	2.2500	5.34	17.83	23.17	46.00	-22.83	AVG	
10	2.3260	15.55	17.83	33.38	56.00	-22.62	QP	
11	3.3780	1.05	17.84	18.89	46.00	-27.11	AVG	
12	4.6299	0.00	17.85	17.85	46.00	-28.15	AVG	

Note: Only record the worst data in the report.



## 4. Occupied Bandwidth

Test Requirement:	47 CFR 15.215(c)
Test Limit:	Refer to 47 CFR 15.215(c), intentional radiators operating under the alternative provisions to the general emission limits, as contained in §§ 15.217 through 15.257 and in subpart E of this part, must be designed to ensure that the 20 dB bandwidth of the emission, or whatever bandwidth may otherwise be specified in the specific rule section under which the equipment operates, is contained within the frequency band designated in the rule section under which the equipment is operated.
Test Method:	ANSI C63.10-2020, section 7.8.6, For occupied bandwidth measurements, use the procedure in 6.9.3. Frequency hopping shall be disabled for this test.
Procedure:	<p>The occupied bandwidth is the frequency bandwidth such that, below its lower and above its upper frequency limits, the mean powers are each equal to 0.5% of the total mean power of the given emission. The following procedure shall be used for measuring 99% power bandwidth:</p> <ul style="list-style-type: none"> <li>a) The instrument center frequency is set to the nominal EUT channel center frequency. The frequency span for the spectrum analyzer shall be between 1.5 times and 5.0 times the OBW.</li> <li>b) The nominal IF filter bandwidth (3 dB RBW) shall be in the range of 1% to 5% of the OBW, and VBW shall be at least three times the RBW, unless otherwise specified by the applicable requirement.</li> <li>c) Set the reference level of the instrument as required, keeping the signal from exceeding the maximum input mixer level for linear operation. In general, the peak of the spectral envelope shall be more than [10 log (OBW/RBW)] below the reference level. Specific guidance is given in 4.1.6.2.</li> <li>d) Step a) through step c) might require iteration to adjust within the specified range.</li> <li>e) Video averaging is not permitted. Where practical, a sample detection and single sweep mode shall be used. Otherwise, peak detection and max-hold mode (until the trace stabilizes) shall be used.</li> <li>f) Use the 99% power bandwidth function of the instrument (if available) and report the measured bandwidth.</li> <li>g) If the instrument does not have a 99% power bandwidth function, then the trace data points are recovered and directly summed in linear power terms. The recovered amplitude data points, beginning at the lowest frequency, are placed in a running sum until 0.5% of the total is reached; that frequency is recorded as the lower frequency. The process is repeated until 99.5% of the total is reached; that frequency is recorded as the upper frequency. The 99% power bandwidth is the difference between these two frequencies.</li> <li>h) The occupied bandwidth shall be reported by providing spectral plot(s) of the measuring instrument display; the plot axes and the scale units per division shall be clearly labeled. Tabular data may be reported in addition to the plot(s).</li> </ul>

### 4.1. EUT Operation

Operating Environment:	
Test mode:	1: TX-GFSK (Non-Hopping): Keep the EUT in continuously transmitting mode (non-hopping) with GFSK modulation.

#### Shenzhen Anbotek Compliance Laboratory Limited

Address: 1/F., Building D, Sogood Science and Technology Park, Sanwei Community, Hangcheng Street, Bao'an District, Shenzhen, Guangdong, China.  
 Tel: (86)0755-26066440 Fax: (86)0755-26014772 Email: service@anbotek.com



Hotline  
 400-003-0500  
[www.anbotek.com.cn](http://www.anbotek.com.cn)



2: TX- $\pi/4$ -DQPSK (Non-Hopping): Keep the EUT in continuously transmitting mode (non-hopping) with $\pi/4$ DQPSK modulation. 3: TX-8DPSK (Non-Hopping): Keep the EUT in continuously transmitting mode (non-hopping) with 8DPSK modulation.
--

#### 4.2. Test Setup

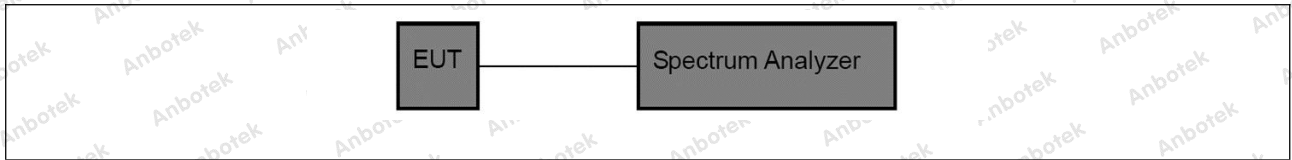

#### 4.3. Test Data

Temperature:	24.3 °C	Humidity:	49 %	Atmospheric Pressure:	101 kPa
--------------	---------	-----------	------	-----------------------	---------

Please Refer to Appendix for Details.



## 5. Maximum Conducted Output Power

Test Requirement:	47 CFR 15.247(b)(1)
Test Limit:	Refer to 47 CFR 15.247(b)(1), For frequency hopping systems operating in the 2400-2483.5 MHz band employing at least 75 non-overlapping hopping channels, and all frequency hopping systems in the 5725-5850 MHz band: 1 watt. For all other frequency hopping systems in the 2400-2483.5 MHz band: 0.125 watts.
Test Method:	ANSI C63.10-2020, section 7.8.5
Procedure:	<p>This is an RF-conducted test to evaluate maximum peak output power. Use a direct connection between the antenna port of the unlicensed wireless device and the spectrum analyzer, through suitable attenuation. Frequency hopping shall be disabled for this test. Use the following spectrum analyzer settings:</p> <ul style="list-style-type: none"> <li>a) Span: Approximately five times the 20 dB bandwidth, centered on a hopping channel.</li> <li>b) RBW &gt; 20 dB bandwidth of the emission being measured.</li> <li>c) VBW ≥ RBW.</li> <li>d) Sweep: No faster than coupled (auto) time.</li> <li>e) Detector function: Peak.</li> <li>f) Trace: Max-hold.</li> <li>g) Allow trace to stabilize.</li> <li>h) Use the marker-to-peak function to set the marker to the peak of the emission.</li> <li>i) The indicated level is the peak output power, after any corrections for external attenuators and cables.</li> <li>j) A spectral plot of the test results and setup description shall be included in the test report.</li> </ul> <p>NOTE—A peak responding power meter may be used, where the power meter and sensor system video bandwidth is greater than the occupied bandwidth of the unlicensed wireless device, rather than a spectrum analyzer.</p>

### 5.1. EUT Operation

Operating Environment:	
Test mode:	<ul style="list-style-type: none"> <li>1: TX-GFSK (Non-Hopping): Keep the EUT in continuously transmitting mode (non-hopping) with GFSK modulation.</li> <li>2: TX-π/4-DQPSK (Non-Hopping): Keep the EUT in continuously transmitting mode (non-hopping) with π/4 DQPSK modulation.</li> <li>3: TX-8DPSK (Non-Hopping): Keep the EUT in continuously transmitting mode (non-hopping) with 8DPSK modulation.</li> </ul>



## 5.2. Test Setup

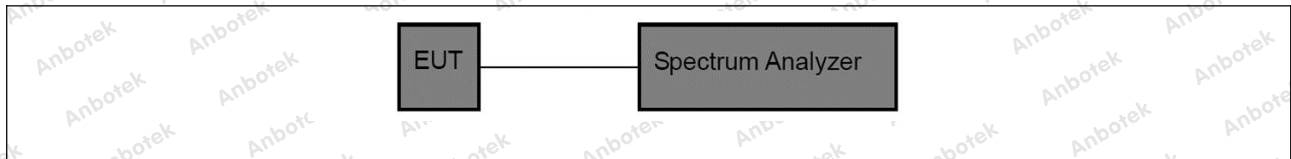

## 5.3. Test Data

Temperature:	24.3 °C	Humidity:	49 %	Atmospheric Pressure:	101 kPa
--------------	---------	-----------	------	-----------------------	---------

Please Refer to Appendix for Details.



## 6. Channel Separation

Test Requirement:	47 CFR 15.247(a)(1)
Test Limit:	Refer to 47 CFR 15.247(a)(1), Frequency hopping systems shall have hopping channel carrier frequencies separated by a minimum of 25 kHz or the 20 dB bandwidth of the hopping channel, whichever is greater. Alternatively, frequency hopping systems operating in the 2400-2483.5 MHz band may have hopping channel carrier frequencies that are separated by 25 kHz or two-thirds of the 20 dB bandwidth of the hopping channel, whichever is greater, provided the systems operate with an output power no greater than 125 mW.
Test Method:	ANSI C63.10-2020, section 7.8.2
Procedure:	The EUT shall have its hopping function enabled. Use the following spectrum analyzer settings: a) Span: Wide enough to capture the peaks of two adjacent channels. b) RBW: Start with the RBW set to approximately 30% of the channel spacing; adjust as necessary to best identify the center of each individual channel. c) Video (or average) bandwidth (VBW) $\geq$ RBW. d) Sweep: No faster than coupled (auto) time. e) Detector function: Peak. f) Trace: Max-hold. g) Allow the trace to stabilize.  Use the marker-delta function to determine the separation between the peaks of the adjacent channels. Compliance of an EUT with the appropriate regulatory limit shall be determined. A spectral plot of the data shall be included in the test report.

### 6.1. EUT Operation

Operating Environment:	
Test mode:	4: TX-GFSK (Hopping): Keep the EUT in continuously transmitting mode (hopping) with GFSK modulation. 5: TX- $\pi/4$ -DQPSK (Hopping): Keep the EUT in continuously transmitting mode (hopping) with $\pi/4$ DQPSK modulation. 6: TX-8DPSK (Hopping): Keep the EUT in continuously transmitting mode (hopping) with 8DPSK modulation.

### 6.2. Test Setup

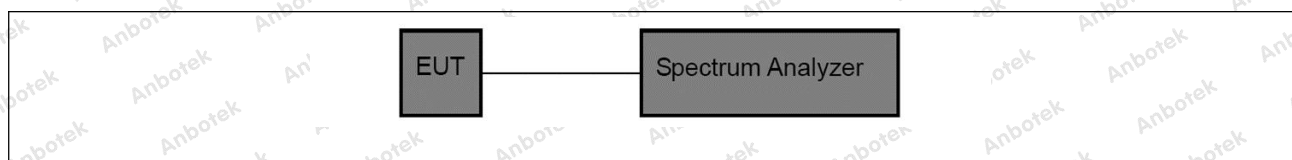

### 6.3. Test Data

Temperature:	24.3 °C	Humidity:	49 %	Atmospheric Pressure:	101 kPa
--------------	---------	-----------	------	-----------------------	---------

Please Refer to Appendix for Details.

#### Shenzhen Anbotek Compliance Laboratory Limited

Address: 1/F., Building D, Sogood Science and Technology Park, Sanwei Community, Hangcheng Street, Bao'an District, Shenzhen, Guangdong, China.  
Tel: (86)0755-26066440 Fax: (86)0755-26014772 Email: service@anbotek.com

Hotline  
400-003-0500  
www.anbotek.com.cn



## 7. Number of Hopping Frequencies

Test Requirement:	47 CFR 15.247(a)(1)(iii)
Test Limit:	Refer to 47 CFR 15.247(a)(1)(iii), Frequency hopping systems in the 2400-2483.5 MHz band shall use at least 15 channels. The average time of occupancy on any channel shall not be greater than 0.4 seconds within a period of 0.4 seconds multiplied by the number of hopping channels employed. Frequency hopping systems may avoid or suppress transmissions on a particular hopping frequency provided that a minimum of 15 channels are used.
Test Method:	ANSI C63.10-2020, section 7.8.3
Procedure:	<p>The EUT shall have its hopping function enabled. Use the following spectrum analyzer settings:</p> <ul style="list-style-type: none"> <li>a) Span: The frequency band of operation. Depending on the number of channels the device supports, it could be necessary to divide the frequency range of operation across multiple spans, to allow the individual channels to be clearly seen.</li> <li>b) RBW: To identify clearly the individual channels, set the RBW to less than 30% of the channel spacing or the 20 dB bandwidth, whichever is smaller.</li> <li>c) VBW <math>\geq</math> RBW.</li> <li>d) Sweep: No faster than coupled (auto) time.</li> <li>e) Detector function: Peak.</li> <li>f) Trace: Max-hold.</li> <li>g) Allow the trace to stabilize.</li> </ul> <p>It might prove necessary to break the span up into subranges to show clearly all of the hopping frequencies. Compliance of an EUT with the appropriate regulatory limit shall be determined for the number of hopping channels. A spectral plot of the data shall be included in the test report.</p>

### 7.1. EUT Operation

Operating Environment:	
Test mode:	<ul style="list-style-type: none"> <li>4: TX-GFSK (Hopping): Keep the EUT in continuously transmitting mode (hopping) with GFSK modulation,.</li> <li>5: TX-<math>\pi/4</math>-DQPSK (Hopping): Keep the EUT in continuously transmitting mode (hopping) with <math>\pi/4</math> DQPSK modulation.</li> <li>6: TX-8DPSK (Hopping): Keep the EUT in continuously transmitting mode (hopping) with 8DPSK modulation.</li> </ul>

### 7.2. Test Setup

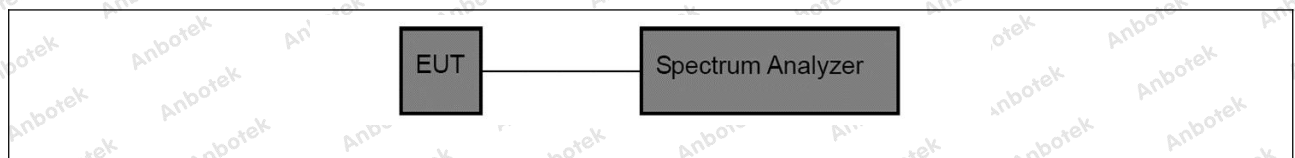

**7.3. Test Data**

Temperature:	24.3 °C	Humidity:	49 %	Atmospheric Pressure:	101 kPa
--------------	---------	-----------	------	-----------------------	---------

Please Refer to Appendix for Details.

**Shenzhen Anbotek Compliance Laboratory Limited**

Address: 1/F., Building D, Sogood Science and Technology Park, Sanwei Community, Hangcheng Street, Bao'an District, Shenzhen, Guangdong, China.  
Tel: (86)0755-26066440 Fax: (86)0755-26014772 Email: service@anbotek.com



Hotline  
400-003-0500  
www.anbotek.com.cn





## 8. Dwell Time

Test Requirement:	47 CFR 15.247(a)(1)(iii)
Test Limit:	Refer to 47 CFR 15.247(a)(1)(iii), Frequency hopping systems in the 2400-2483.5 MHz band shall use at least 15 channels. The average time of occupancy on any channel shall not be greater than 0.4 seconds within a period of 0.4 seconds multiplied by the number of hopping channels employed. Frequency hopping systems may avoid or suppress transmissions on a particular hopping frequency provided that a minimum of 15 channels are used.
Test Method:	ANSI C63.10-2020, section 7.8.4
Procedure:	<p>The dwell time per hop on a channel is the time from the start of the first transmission to the end of the last transmission for that hop. If the device has a single transmission per hop then the dwell time is the duration of that transmission. If the device has a multiple transmissions per hop then the dwell time is measured from the start of the first transmission to the end of the last transmission.</p> <p>The time of occupancy is the total time that the device dwells on a channel over an observation period specified in the regulatory requirement. To determine the time of occupancy the spectrum analyzer will be configured to measure both the dwell time per hop and the number of times the device transmits on a specific channel in a given period.</p> <p>The EUT shall have its hopping function enabled. Compliance with the requirements shall be made with the minimum and with the maximum number of channels enabled. If the dwell time per channel does not vary with the number of channels then compliance with the requirements may be based on the minimum number of channels. If the device supports different dwell times per channel (example Bluetooth devices can dwell on a channel for 1, 3 or 5 time slots) then measurements can be limited to the longest dwell time with the minimum number of channels.</p> <p>Use the following spectrum analyzer settings to determine the dwell time per hop:</p> <ol style="list-style-type: none"> <li>Span: Zero span, centered on a hopping channel.</li> <li>RBW shall be <math>\leq</math> channel spacing and where possible RBW should be set <math>\gg 1/T</math>, where T is the expected transmission time per hop.</li> <li>Sweep time: Set so that the start of the first transmission and end of the last transmission for the hop are clearly captured. Setting the sweep time to be slightly longer than the hopping period per channel (hopping period = <math>1/\text{hopping rate}</math>) should achieve this.</li> <li>Use a video trigger, where possible with a trigger delay, so that the start of the transmission is clearly observed. The trigger level might need adjustment to reduce the chance of triggering when the system hops on an adjacent channel.</li> <li>Detector function: Peak.</li> <li>Trace: Clear-write, single sweep.</li> <li>Place markers at the start of the first transmission on the channel and at the end of the last transmission. The dwell time per hop is the time between</li> </ol>

### Shenzhen Anbotek Compliance Laboratory Limited

Address: 1/F., Building D, Sogood Science and Technology Park, Sanwei Community, Hangcheng Street, Bao'an District, Shenzhen, Guangdong, China.  
Tel: (86)0755-26066440 Fax: (86)0755-26014772 Email: service@anbotek.com



Hotline  
400-003-0500  
www.anbotek.com.cn



	<p>these two markers.</p> <p>To determine the number of hops on a channel in the regulatory observation period repeat the measurement using a longer sweep time. When the device uses a single hopping sequence the period of measurement should be sufficient to capture at least 2 hops. When the device uses a dynamic hopping sequence, or the sequence varies, the period of measurement may need to capture multiple hops to better determine the average time of occupancy. Count the number of hops on the channel across the sweep time.</p> <p>The average number of hops on the same channel within the regulatory observation period is calculated from the number of hops on the channel divided by the spectrum analyzer sweep time multiplied by the regulatory observation period. For example, if three hops are counted with an analyzer sweep time of 500 ms and the regulatory observation period is 10 s, then the number of hops in that ten seconds is <math>3 / 0.5 \times 10</math>, or 60 hops.</p> <p>The average time of occupancy is calculated by multiplying the dwell time per hop by the number of hops in the observation period.</p>
--	---

### 8.1. EUT Operation

Operating Environment:	
Test mode:	<p>4: TX-GFSK (Hopping): Keep the EUT in continuously transmitting mode (hopping) with GFSK modulation.</p> <p>5: TX-<math>\pi/4</math>-DQPSK (Hopping): Keep the EUT in continuously transmitting mode (hopping) with <math>\pi/4</math> DQPSK modulation.</p> <p>6: TX-8DPSK (Hopping): Keep the EUT in continuously transmitting mode (hopping) with 8DPSK modulation.</p>

### 8.2. Test Setup

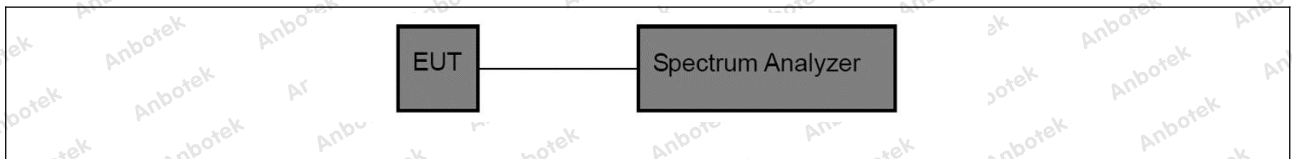

### 8.3. Test Data

Temperature:	24.3 °C	Humidity:	49 %	Atmospheric Pressure:	101 kPa
--------------	---------	-----------	------	-----------------------	---------

Please Refer to Appendix for Details.

#### Shenzhen Anbotek Compliance Laboratory Limited

Address: 1/F., Building D, Sogood Science and Technology Park, Sanwei Community, Hangcheng Street, Bao'an District, Shenzhen, Guangdong, China.  
 Tel: (86)0755-26066440 Fax: (86)0755-26014772 Email: service@anbotek.com



Hotline  
 400-003-0500  
[www.anbotek.com.cn](http://www.anbotek.com.cn)



## 9. Emissions in non-restricted frequency bands

Test Requirement:	47 CFR 15.247(d), 15.209, 15.205
Test Limit:	<p>Refer to 47 CFR 15.247(d), In any 100 kHz bandwidth outside the frequency band in which the spread spectrum or digitally modulated intentional radiator is operating, the radio frequency power that is produced by the intentional radiator shall be at least 20 dB below that in the 100 kHz bandwidth within the band that contains the highest level of the desired power, based on either an RF conducted or a radiated measurement, provided the transmitter demonstrates compliance with the peak conducted power limits. If the transmitter complies with the conducted power limits based on the use of RMS averaging over a time interval, as permitted under paragraph (b)(3) of this section, the attenuation required under this paragraph shall be 30 dB instead of 20 dB. Attenuation below the general limits specified in § 15.209(a) is not required.</p>
Test Method:	ANSI C63.10-2020 section 7.8.7
Procedure:	<p><b>7.8.7.1 General considerations</b>          To demonstrate compliance with the relative out-of-band emissions requirements conducted spurious emissions shall be measured for the transmit frequencies, per 5.5 and 5.6, and at the maximum transmit powers. Frequency hopping shall be disabled for this test with the exception of measurements at the allocated band-edges which shall be repeated with hopping enabled.</p> <p>Connect the primary antenna port through an attenuator to the spectrum analyzer input; in the results, account for all losses between the unlicensed wireless device output and the spectrum analyzer. The frequency range of testing shall span 30 MHz to 10 times the operating frequency and this may be done in a single sweep or, to aid resolution, across a number of sweeps. The resolution bandwidth shall be 100 kHz, video bandwidth 300 kHz, and a coupled sweep time with a peak detector.</p> <p>The limit is based on the highest in-band level across all channels measured using the same instrument settings (resolution bandwidth of 100 kHz, video bandwidth of 300 kHz, and a coupled sweep time with a peak detector). To help clearly demonstrate compliance a display line may be set at the required offset (typically 20 dB) below the highest in-band level. Where the highest in-band level is not clearly identified in the out-of-band measurements a separate spectral plot showing the in-band level shall be provided.</p> <p>When conducted measurements cannot be made (for example a device with integrated, non-removable antenna) radiated measurements shall be used. The reference level for determining the limit shall be established by maximizing the field strength from the highest power channel and measuring using the resolution and video bandwidth settings and peak detector as described above. The field strength limit for spurious emissions outside of restricted-bands shall then be set at the required offset (typically 20 dB) below the highest in-band level. Radiated measurements will follow the standards measurement procedures described in Clause 6 with the exception that the resolution bandwidth shall be 100 kHz, video bandwidth</p>



	<p>300 kHz, and a coupled sweep time with a peak detector. Note that use of wider measurement bandwidths are acceptable for measuring the spurious emissions provided that the peak detector is used and that the measured value of spurious emissions are compared to the highest in-band level measured with the 100 kHz / 300 kHz bandwidth settings to determine compliance.</p> <p><b>7.8.7.2 Band-edges</b> Compliance with a relative limit at the band-edges (e.g., -20 dBc) shall be made on the lowest and on the highest channels with frequency hopping disabled and repeated with frequency hopping enabled. For the latter test the hopping sequence shall include the lowest and highest channels.</p> <p>For measurements with the hopping disabled the analyzer screen shall clearly show compliance with the requirement within 10 MHz of the allocated band-edge.</p> <p>For measurements with the hopping enabled the analyzer screen shall clearly show compliance with the requirement within 10 MHz of both of the allocated band-edges. This could require separate spectral plots for each band-edge.</p>
--	--

## 9.1. EUT Operation

Operating Environment:	
Test mode:	<ol style="list-style-type: none"> <li>1: TX-GFSK (Non-Hopping): Keep the EUT in continuously transmitting mode (non-hopping) with GFSK modulation.</li> <li>2: TX-<math>\pi/4</math>-DQPSK (Non-Hopping): Keep the EUT in continuously transmitting mode (non-hopping) with <math>\pi/4</math> DQPSK modulation.</li> <li>3: TX-8DPSK (Non-Hopping): Keep the EUT in continuously transmitting mode (non-hopping) with 8DPSK modulation.</li> <li>4: TX-GFSK (Hopping): Keep the EUT in continuously transmitting mode (hopping) with GFSK modulation,.</li> <li>5: TX-<math>\pi/4</math>-DQPSK (Hopping): Keep the EUT in continuously transmitting mode (hopping) with <math>\pi/4</math> DQPSK modulation.</li> <li>6: TX-8DPSK (Hopping): Keep the EUT in continuously transmitting mode (hopping) with 8DPSK modulation.</li> </ol>

## 9.2. Test Setup

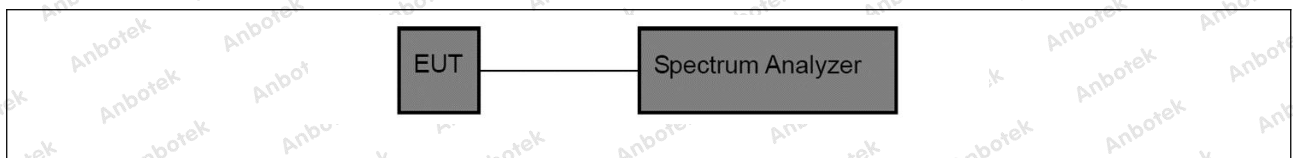

## 9.3. Test Data

Temperature:	24.3 °C	Humidity:	49 %	Atmospheric Pressure:	101 kPa
--------------	---------	-----------	------	-----------------------	---------

Please Refer to Appendix for Details.

### Shenzhen Anbotek Compliance Laboratory Limited

Address: 1/F., Building D, Sogood Science and Technology Park, Sanwei Community, Hangcheng Street, Bao'an District, Shenzhen, Guangdong, China.  
Tel: (86)0755-26066440 Fax: (86)0755-26014772 Email: service@anbotek.com



Hotline  
400-003-0500  
www.anbotek.com.cn



## 10. Band edge emissions (Radiated)

Test Requirement:	Refer to 47 CFR 15.247(d), In addition, radiated emissions which fall in the restricted bands, as defined in § 15.205(a), must also comply with the radiated emission limits specified in § 15.209(a)(see § 15.205(c)).`		
Test Limit:	Frequency (MHz)	Field strength (microvolts/meter)	Measurement distance (meters)
	0.009-0.490	2400/F(kHz)	300
	0.490-1.705	24000/F(kHz)	30
	1.705-30.0	30	30
	30-88	100 **	3
	88-216	150 **	3
	216-960	200 **	3
	Above 960	500	3
	** Except as provided in paragraph (g), fundamental emissions from intentional radiators operating under this section shall not be located in the frequency bands 54-72 MHz, 76-88 MHz, 174-216 MHz or 470-806 MHz. However, operation within these frequency bands is permitted under other sections of this part, e.g., §§ 15.231 and 15.241. In the emission table above, the tighter limit applies at the band edges. The emission limits shown in the above table are based on measurements employing a CISPR quasi-peak detector except for the frequency bands 9–90 kHz, 110–490 kHz and above 1000 MHz. Radiated emission limits in these three bands are based on measurements employing an average detector.		
Test Method:	ANSI C63.10-2020 section 6.10		
Procedure:	ANSI C63.10-2020 section 6.10.5.2		

### 10.1. EUT Operation

Operating Environment:	
Test mode:	<p>1: TX-GFSK (Non-Hopping): Keep the EUT in continuously transmitting mode (non-hopping) with GFSK modulation.</p> <p>2: TX-<math>\pi/4</math>-DQPSK (Non-Hopping): Keep the EUT in continuously transmitting mode (non-hopping) with <math>\pi/4</math> DQPSK modulation.</p> <p>3: TX-8DPSK (Non-Hopping): Keep the EUT in continuously transmitting mode (non-hopping) with 8DPSK modulation.</p>

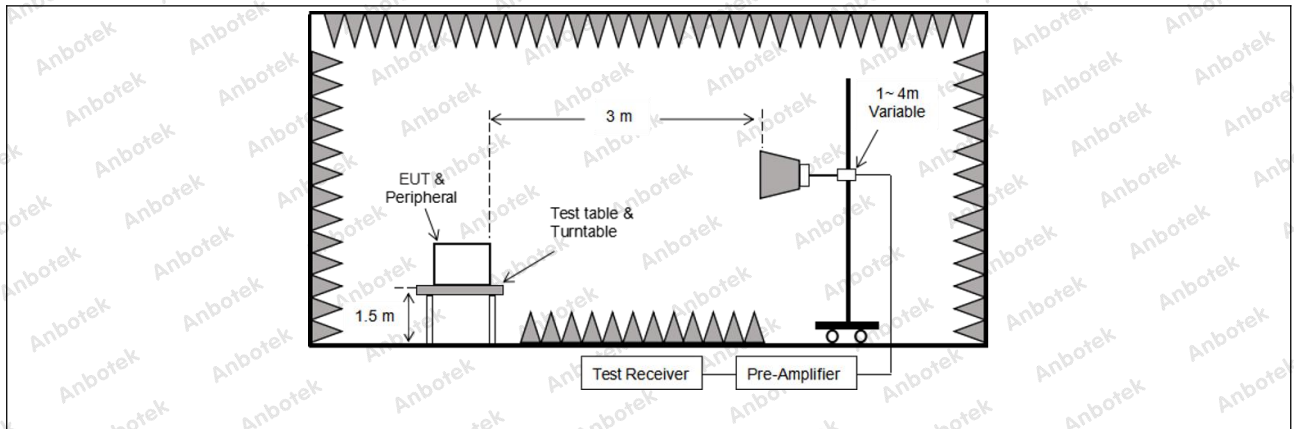

**10.2. Test Setup****Shenzhen Anbotek Compliance Laboratory Limited**

Address: 1/F., Building D, Sogood Science and Technology Park, Sanwei Community, Hangcheng Street, Bao'an District, Shenzhen, Guangdong, China.  
Tel: (86)0755-26066440 Fax: (86)0755-26014772 Email: service@anbotek.com



Hotline  
400-003-0500  
www.anbotek.com.cn



### 10.3. Test Data

Temperature:	24.3 °C	Humidity:	49 %	Atmospheric Pressure:	101 kPa
--------------	---------	-----------	------	-----------------------	---------

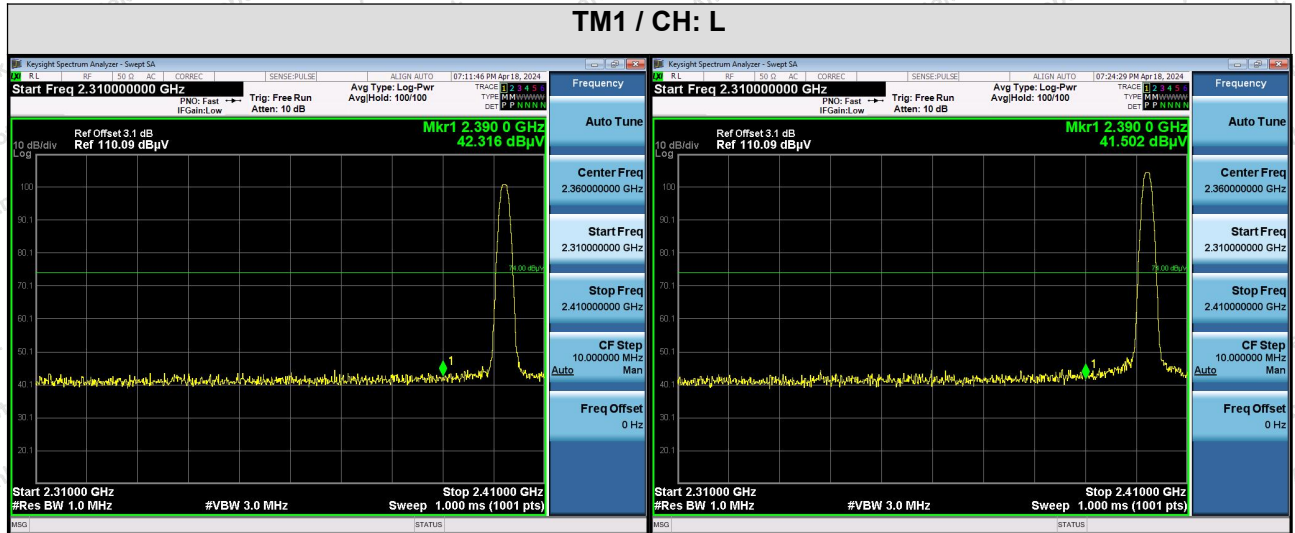

Peak Value(Vertical)

Peak Value(Horizontal)

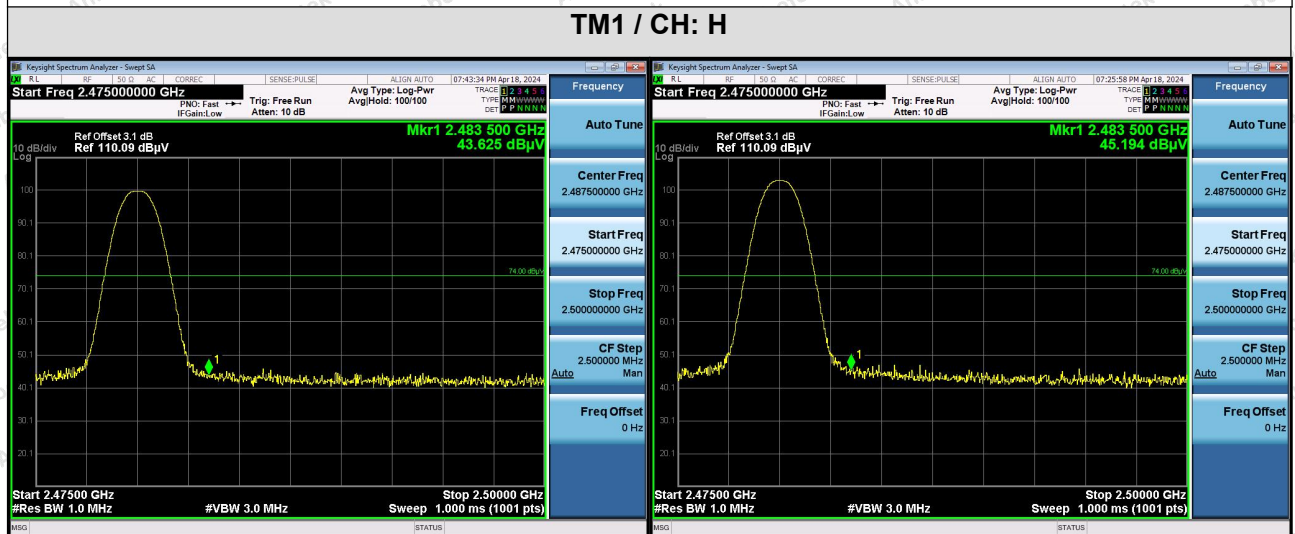

Peak Value(Vertical)

Peak Value(Horizontal)

**Remark:**

1. During the test, pre-scan all modes, the report only record the worse case mode.
2. When the PK measure result value is less than the AVG limit value, the AV measure result values test not applicable.



## 11. Emissions in frequency bands (below 1GHz)

Test Requirement:	Refer to 47 CFR 15.247(d), In addition, radiated emissions which fall in the restricted bands, as defined in § 15.205(a), must also comply with the radiated emission limits specified in § 15.209(a)(see § 15.205(c)).`		
Test Limit:	Frequency (MHz)	Field strength (microvolts/meter)	Measurement distance (meters)
	0.009-0.490	2400/F(kHz)	300
	0.490-1.705	24000/F(kHz)	30
	1.705-30.0	30	30
	30-88	100 **	3
	88-216	150 **	3
	216-960	200 **	3
	Above 960	500	3
Test Method:	ANSI C63.10-2020 section 6.6.4		
Procedure:	ANSI C63.10-2020 section 6.6.4		

\*\* Except as provided in paragraph (g), fundamental emissions from intentional radiators operating under this section shall not be located in the frequency bands 54-72 MHz, 76-88 MHz, 174-216 MHz or 470-806 MHz. However, operation within these frequency bands is permitted under other sections of this part, e.g., §§ 15.231 and 15.241. In the emission table above, the tighter limit applies at the band edges. The emission limits shown in the above table are based on measurements employing a CISPR quasi-peak detector except for the frequency bands 9–90 kHz, 110–490 kHz and above 1000 MHz. Radiated emission limits in these three bands are based on measurements employing an average detector.

### 11.1. EUT Operation

Operating Environment:	
Test mode:	<p>1: TX-GFSK (Non-Hopping): Keep the EUT in continuously transmitting mode (non-hopping) with GFSK modulation.</p> <p>2: TX-<math>\pi/4</math>-DQPSK (Non-Hopping): Keep the EUT in continuously transmitting mode (non-hopping) with <math>\pi/4</math> DQPSK modulation.</p> <p>3: TX-8DPSK (Non-Hopping): Keep the EUT in continuously transmitting mode (non-hopping) with 8DPSK modulation.</p>





## 11.2. Test Setup

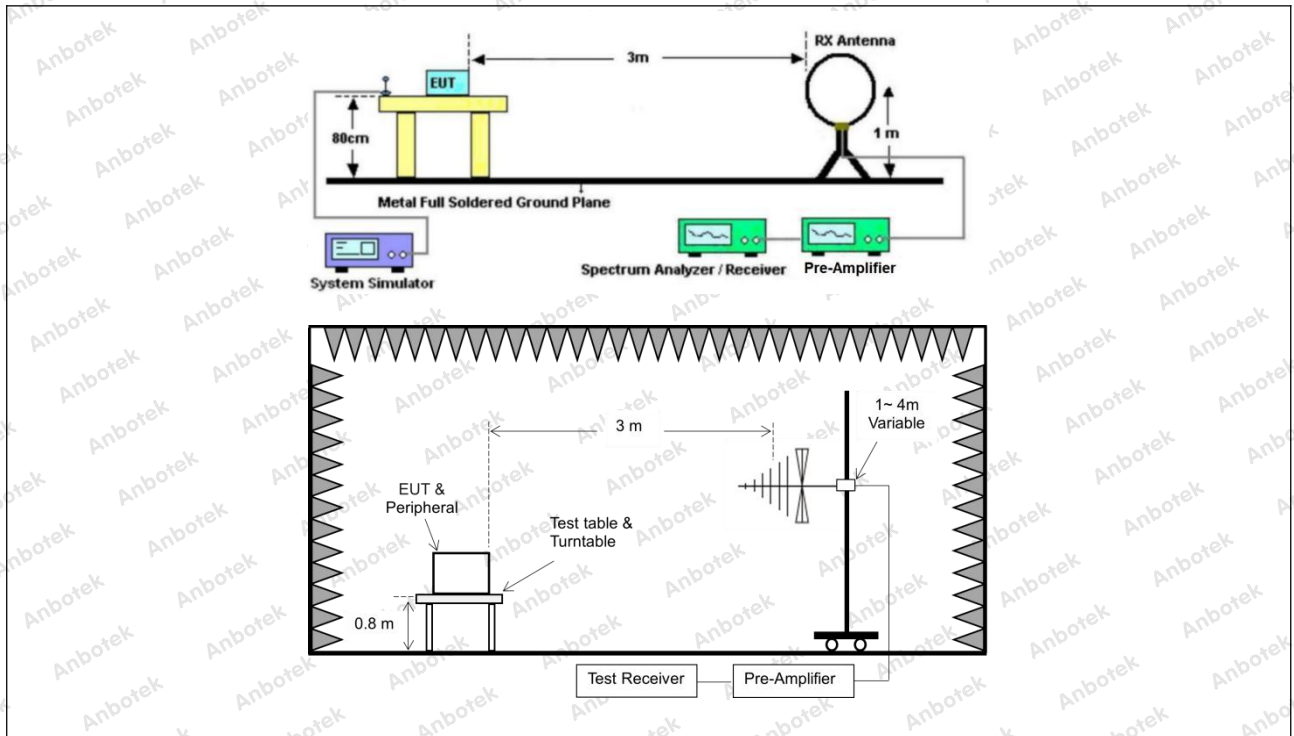

### 11.3. Test Data

The test results of 9kHz-30MHz was attenuated more than 20dB below the permissible limits, so the results don't record in the report.

Temperature:	24.3 °C	Humidity:	49 %	Atmospheric Pressure:	101 kPa
--------------	---------	-----------	------	-----------------------	---------

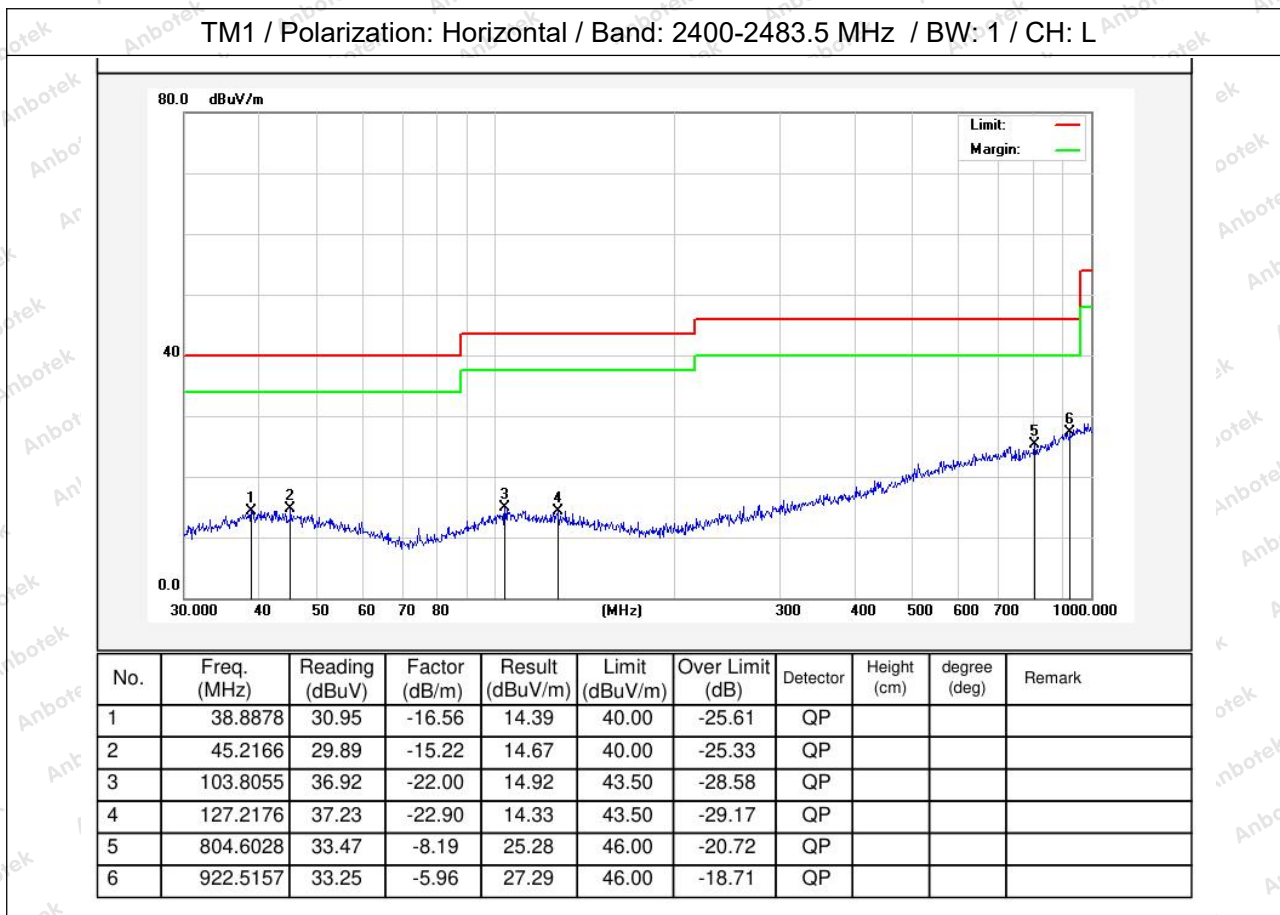

Temperature:	24.3 °C	Humidity:	49 %	Atmospheric Pressure:	101 kPa
--------------	---------	-----------	------	-----------------------	---------

TM1 / Polarization: Vertical / Band: 2400-2483.5 MHz / BW: 1 / CH: L

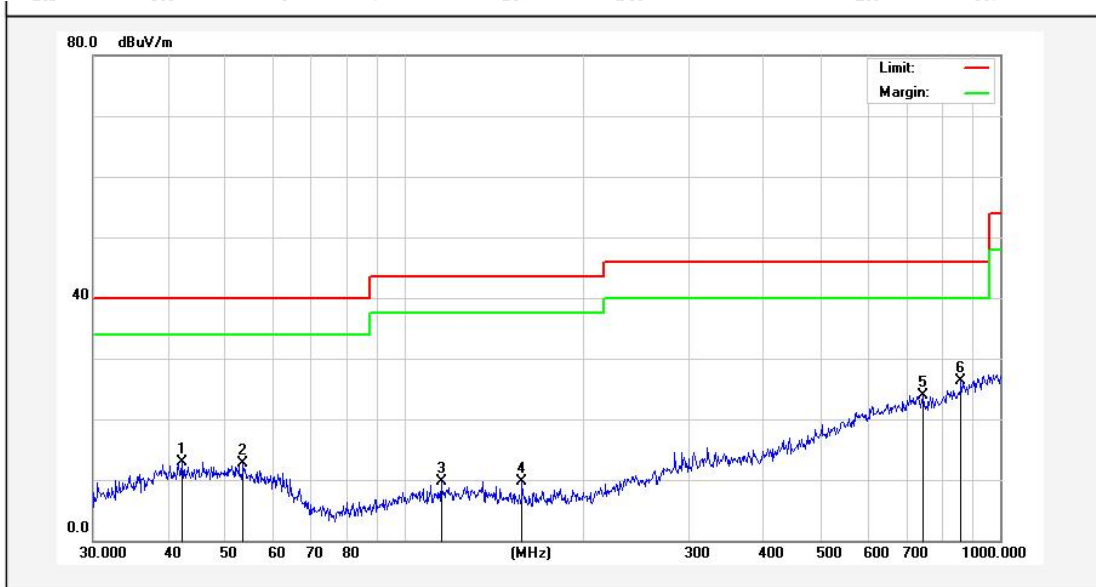

No.	Freq. (MHz)	Reading (dBUV)	Factor (dB/m)	Result (dBUV/m)	Limit (dBUV/m)	Over Limit (dB)	Detector	Height (cm)	degree (deg)	Remark
1	42.3022	27.73	-14.79	12.94	40.00	-27.06	QP			
2	53.5052	29.73	-17.07	12.66	40.00	-27.34	QP			
3	115.3205	28.91	-19.12	9.79	43.50	-33.71	QP			
4	157.5588	31.42	-21.76	9.66	43.50	-33.84	QP			
5	742.2587	33.25	-9.34	23.91	46.00	-22.09	QP			
6	860.0352	33.47	-7.24	26.23	46.00	-19.77	QP			

Note: Only record the worst data in the report.



## 12. Emissions in frequency bands (above 1GHz)

Test Requirement:	In addition, radiated emissions which fall in the restricted bands, as defined in § 15.205(a), must also comply with the radiated emission limits specified in § 15.209(a)(see § 15.205(c)).		
Test Limit:	Frequency (MHz)	Field strength (microvolts/meter)	Measurement distance (meters)
	0.009-0.490	2400/F(kHz)	300
	0.490-1.705	24000/F(kHz)	30
	1.705-30.0	30	30
	30-88	100 **	3
	88-216	150 **	3
	216-960	200 **	3
	Above 960	500	3
	<p>** Except as provided in paragraph (g), fundamental emissions from intentional radiators operating under this section shall not be located in the frequency bands 54-72 MHz, 76-88 MHz, 174-216 MHz or 470-806 MHz. However, operation within these frequency bands is permitted under other sections of this part, e.g., §§ 15.231 and 15.241.</p> <p>In the emission table above, the tighter limit applies at the band edges. The emission limits shown in the above table are based on measurements employing a CISPR quasi-peak detector except for the frequency bands 9–90 kHz, 110–490 kHz and above 1000 MHz. Radiated emission limits in these three bands are based on measurements employing an average detector.</p>		
Test Method:	ANSI C63.10-2020 section 6.6.4		
Procedure:	ANSI C63.10-2020 section 6.6.4		

### 12.1. EUT Operation

Operating Environment:	
Test mode:	<p>1: TX-GFSK (Non-Hopping): Keep the EUT in continuously transmitting mode (non-hopping) with GFSK modulation.</p> <p>2: TX-<math>\pi/4</math>-DQPSK (Non-Hopping): Keep the EUT in continuously transmitting mode (non-hopping) with <math>\pi/4</math> DQPSK modulation.</p> <p>3: TX-8DPSK (Non-Hopping): Keep the EUT in continuously transmitting mode (non-hopping) with 8DPSK modulation.</p>

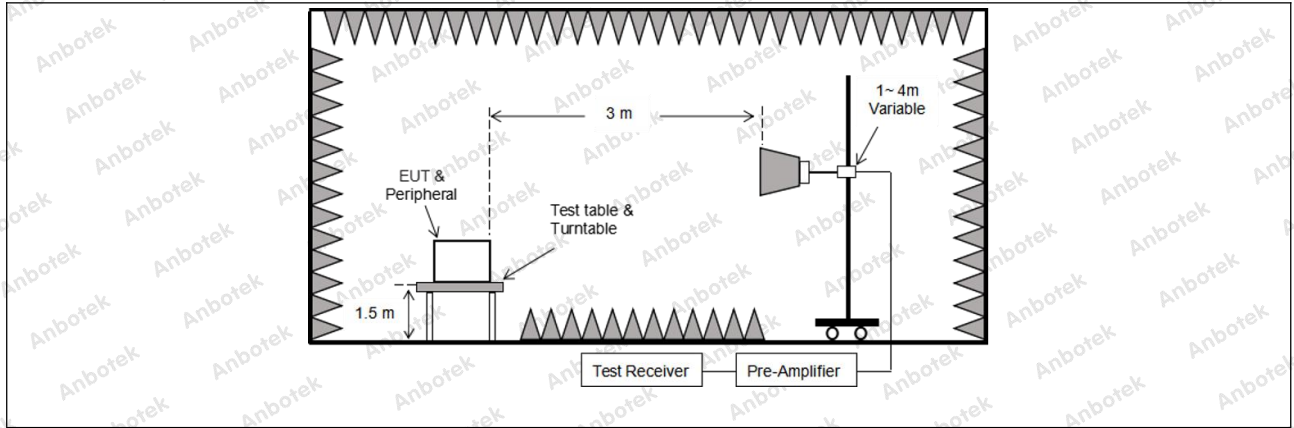

**12.2. Test Setup****Shenzhen Anbotek Compliance Laboratory Limited**

Address: 1/F., Building D, Sogood Science and Technology Park, Sanwei Community, Hangcheng Street, Bao'an District, Shenzhen, Guangdong, China.  
Tel: (86)0755-26066440 Fax: (86)0755-26014772 Email: service@anbotek.com



Hotline  
400-003-0500  
www.anbotek.com.cn



### 12.3. Test Data

Temperature:	24.3 °C	Humidity:	49 %	Atmospheric Pressure:	101 kPa
--------------	---------	-----------	------	-----------------------	---------

TM1 / CH: L						
Peak value:						
Frequency (MHz)	Reading (dBuV)	Factor (dB/m)	Result (dBuV/m)	Limit Line (dBuV/m)	Over Limit (dB)	polarization
4804.00	28.98	15.27	44.25	74.00	-29.75	Vertical
7206.00	29.84	18.09	47.93	74.00	-26.07	Vertical
9608.00	31.28	23.76	55.04	74.00	-18.96	Vertical
12010.00	*			74.00		Vertical
14412.00	*			74.00		Vertical
4804.00	29.20	15.27	44.47	74.00	-29.53	Horizontal
7206.00	30.68	18.09	48.77	74.00	-25.23	Horizontal
9608.00	29.01	23.76	52.77	74.00	-21.23	Horizontal
12010.00	*			74.00		Horizontal
14412.00	*			74.00		Horizontal
Average value:						
Frequency (MHz)	Reading (dBuV)	Factor (dB/m)	Result (dBuV/m)	Limit (dBuV/m)	Over Limit (dB)	polarization
4804.00	18.36	15.27	33.63	54.00	-20.37	Vertical
7206.00	18.87	18.09	36.96	54.00	-17.04	Vertical
9608.00	20.30	23.76	44.06	54.00	-9.94	Vertical
12010.00	*			54.00		Vertical
14412.00	*			54.00		Vertical
4804.00	17.55	15.27	32.82	54.00	-21.18	Horizontal
7206.00	19.74	18.09	37.83	54.00	-16.17	Horizontal
9608.00	18.32	23.76	42.08	54.00	-11.92	Horizontal
12010.00	*			54.00		Horizontal
14412.00	*			54.00		Horizontal

#### Shenzhen Anbotek Compliance Laboratory Limited

Address: 1/F., Building D, Sogood Science and Technology Park, Sanwei Community, Hangcheng Street, Bao'an District, Shenzhen, Guangdong, China.  
 Tel: (86)0755-26066440 Fax: (86)0755-26014772 Email: service@anbotek.com

Hotline  
 400-003-0500  
 www.anbotek.com.cn



TM1 / CH: M						
Peak value:						
Frequency (MHz)	Reading (dBuV)	Factor (dB/m)	Result (dBuV/m)	Limit Line (dBuV/m)	Over Limit (dB)	polarization
4882.00	29.00	15.42	44.42	74.00	-29.58	Vertical
7323.00	29.69	18.02	47.71	74.00	-26.29	Vertical
9764.00	30.29	23.80	54.09	74.00	-19.91	Vertical
12205.00	*			74.00		Vertical
14646.00	*			74.00		Vertical
4882.00	28.90	15.42	44.32	74.00	-29.68	Horizontal
7323.00	30.67	18.02	48.69	74.00	-25.31	Horizontal
9764.00	28.71	23.80	52.51	74.00	-21.49	Horizontal
12205.00	*			74.00		Horizontal
14646.00	*			74.00		Horizontal
Average value:						
Frequency (MHz)	Reading (dBuV)	Factor (dB/m)	Result (dBuV/m)	Limit (dBuV/m)	Over Limit (dB)	polarization
4882.00	18.09	15.42	33.51	54.00	-20.49	Vertical
7323.00	18.97	18.02	36.99	54.00	-17.01	Vertical
9764.00	20.16	23.80	43.96	54.00	-10.04	Vertical
12205.00	*			54.00		Vertical
14646.00	*			54.00		Vertical
4882.00	17.46	15.42	32.88	54.00	-21.12	Horizontal
7323.00	19.30	18.02	37.32	54.00	-16.68	Horizontal
9764.00	18.83	23.80	42.63	54.00	-11.37	Horizontal
12205.00	*			54.00		Horizontal
14646.00	*			54.00		Horizontal

**Shenzhen Anbotek Compliance Laboratory Limited**

Address: 1/F., Building D, Sogood Science and Technology Park, Sanwei Community, Hangcheng Street, Bao'an District, Shenzhen, Guangdong, China.  
 Tel: (86)0755-26066440 Fax: (86)0755-26014772 Email: service@anbotek.com

Hotline 400-003-0500  
 www.anbotek.com.cn



TM1 / CH: H						
Peak value:						
Frequency (MHz)	Reading (dBuV)	Factor (dB/m)	Result (dBuV/m)	Limit Line (dBuV/m)	Over Limit (dB)	polarization
4960.00	29.27	15.58	44.85	74.00	-29.15	Vertical
7440.00	29.70	17.93	47.63	74.00	-26.37	Vertical
9920.00	30.84	23.83	54.67	74.00	-19.33	Vertical
12400.00	*			74.00		Vertical
14880.00	*			74.00		Vertical
4960.00	28.97	15.58	44.55	74.00	-29.45	Horizontal
7440.00	30.70	17.93	48.63	74.00	-25.37	Horizontal
9920.00	29.39	23.83	53.22	74.00	-20.78	Horizontal
12400.00	*			74.00		Horizontal
14880.00	*			74.00		Horizontal
Average value:						
Frequency (MHz)	Reading (dBuV)	Factor (dB/m)	Result (dBuV/m)	Limit (dBuV/m)	Over Limit (dB)	polarization
4960.00	19.21	15.58	34.79	54.00	-19.21	Vertical
7440.00	19.98	17.93	37.91	54.00	-16.09	Vertical
9920.00	20.71	23.83	44.54	54.00	-9.46	Vertical
12400.00	*			54.00		Vertical
14880.00	*			54.00		Vertical
4960.00	18.90	15.58	34.48	54.00	-19.52	Horizontal
7440.00	20.67	17.93	38.60	54.00	-15.40	Horizontal
9920.00	18.73	23.83	42.56	54.00	-11.44	Horizontal
12400.00	*			54.00		Horizontal
14880.00	*			54.00		Horizontal

Remark:

1. Result = Reading + Factor
2. “\*” means the test results were attenuated more than 20dB below the permissible limits, so the results don't record in the report.
3. Only the worst case is recorded in the report.

**Shenzhen Anbotek Compliance Laboratory Limited**

Address: 1/F., Building D, Sogood Science and Technology Park, Sanwei Community, Hangcheng Street, Bao'an District, Shenzhen, Guangdong, China.  
 Tel: (86)0755-26066440 Fax: (86)0755-26014772 Email: service@anbotek.com

Hotline  
 400-003-0500  
 www.anbotek.com.cn





**APPENDIX I -- TEST SETUP PHOTOGRAPH**

Please refer to separated files Appendix I -- Test Setup Photograph\_RF

**APPENDIX II -- EXTERNAL PHOTOGRAPH**

Please refer to separated files Appendix II -- External Photograph

**APPENDIX III -- INTERNAL PHOTOGRAPH**

Please refer to separated files Appendix III -- Internal Photograph

----- End of Report -----

**Shenzhen Anbotek Compliance Laboratory Limited**

Address: 1/F., Building D, Sogood Science and Technology Park, Sanwei Community,  
Hangcheng Street, Bao'an District, Shenzhen, Guangdong, China.  
Tel: (86)0755-26066440 Fax: (86)0755-26014772 Email: service@anbotek.com



Hotline  
400-003-0500  
www.anbotek.com.cn

