



APPLICATION SPECIFICATION

TITLE

2.4GHZ/5GHZ CERAMIC SMT ANTENNA

TABLE OF CONTENTS

1.0 SCOPE

2.0 PRODUCT DESCRIPTION

3.0 APPLICABLE DOCUMENTS

4.0 ANTENNA PERFORMANCE

5.0 MATCHING NETWORK DESCRIPTION

6.0 RECOMMENDED REFLOW CONDITION

7.0 RF PERFORMANCE AS A FUNCTION OF IMPLEMENTATION

REVISION: A	ECR/ECN INFORMATION: EC No: DATE:	TITLE: 2.4GHz/5GHz Ceramic SMT antenna Application Specification	SHEET No. 1 of 26
DOCUMENT NUMBER: 2119640001	CREATED / REVISED BY: Liu Hai 2018/12/24	CHECKED BY: Cooper Zhou 2018/12/24	APPROVED BY: Chris Zhong 2018/12/24

2.4GHZ/5GHZ CERAMIC SMT ANTENNA

1.0 SCOPE

This specification describes the antenna application and surrounding. The information in this document is for reference and benchmark purposes only.

Antenna illustrations in this document are generic representations. They are not intended to be an image of any antenna listed in the scope.

2.0 PRODUCT DESCRIPTION

2.1 PRODUCT NAME AND SERIES NUMBER (S)

Product name: 2.4GHz/5GHz Ceramic SMT antenna

Series Number: 211964****

2.2 DESCRIPTION

211964 is 2.4GHz/5GHz ceramic loop antenna. It works very well when being placed at PCB Center-edge. With applying different matching setup, it supports 2.4GHz single band or 2.4/5GHz dual band.

2.3 PRODUCT STRUCTURE INFORMATION

Please refer to PS-2119640001 for full information.

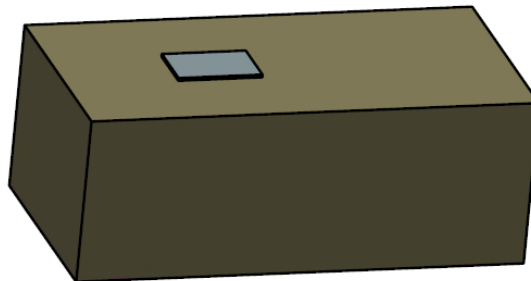

Molex 2119640001 2.4GHz/5GHz Ceramic SMT antenna 3D VIEW

REVISION: A	ECR/ECN INFORMATION: EC No: DATE:	TITLE: 2.4GHz/5GHz Ceramic SMT antenna Application Specification	SHEET No. 2 of 26
DOCUMENT NUMBER: 2119640001	CREATED / REVISED BY: Liu Hai 2018/12/24	CHECKED BY: Cooper Zhou 2018/12/24	APPROVED BY: Chris Zhong 2018/12/24

3.0 APPLICABLE DOCUMENTS

DOCUMENT	NUMBER	DESCRIPTION
Sale Drawing (SD)	SD-2119640001	Mechanical Dimension of the product
Product Specification (PS)	PS-2119640001	Product Specification
Packing Drawing (PK)	PK-2119640001	Product packaging specifications

4.0 ANTENNA PERFORMANCE

4.1 RF TEST CONDITIONS

All measurements are done of the antenna mounted on a reference PCB (40*20*0.8mm) with VNA Agilent E5071C and Over-The-Air (OTA) chamber.



FIGURE4.1.1 ANTENNA LOADED WITH REFERENCE PCB TESTED WITH VNA E5071C

REVISION: A	ECR/ECN INFORMATION: EC No: DATE:	TITLE: 2.4GHz/5GHz Ceramic SMT antenna Application Specification	SHEET No. 3 of 26
DOCUMENT NUMBER: 2119640001	CREATED / REVISED BY: Liu Hai 2018/12/24	CHECKED BY: Cooper Zhou 2018/12/24	APPROVED BY: Chris Zhong 2018/12/24

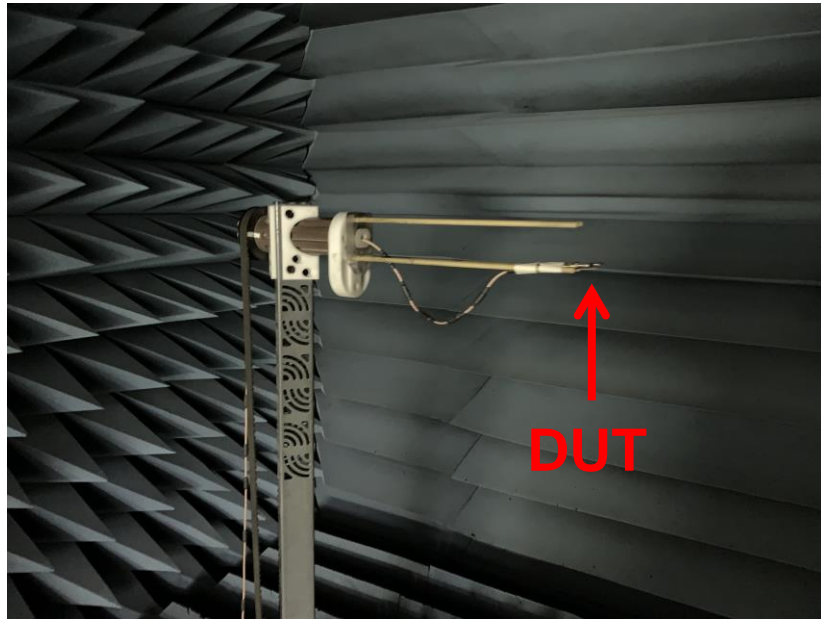

FIGURE 4.1.2 ANTENNA LOADED WITH REFERENCE PCB TESTED IN OTA CHAMBER

4.2 ANTENNA PERFORMANCE

DESCRIPTION	EQUIPMENT	Requirements (For Configure 1)	Requirements (For Configure 2)	
			2.4-2.5GHz	5.15-5.85GHz
Frequency Range	VNA E5071C	2.4-2.5GHz	2.4-2.5GHz	5.15-5.85GHz
Return Loss	VNA E5071C	< -6 dB	< -5 dB	< -5 dB
Peak Gain (Max)	OTA Chamber	2.7dBi	2.1dBi	2.2dBi
Average Total Efficiency	OTA Chamber	>80%	>70%	>65%
Polarization	OTA Chamber	Linear		
Input Impedance	VNA E5071C	50 ohms		

Note that the above antenna performance is measured with just the antenna mounted on a reference PCB to similar a free-space condition. When implement into the system, the frequency resonant might be off-tune due to the loading of surrounding components especially metal plane. This off-tune can be compensated through matching. Although module manufacturers specify a peak gain limit, it is based on free-space conditions. The peak gain will be degraded by 1 to 2dBi in the actual implementation as the radiation pattern will change due to the surround components. As such, during selection of antenna, you can select one with high peak gain to compensate for the loss. Molex can offer assistant to choose the best location and best tuning in-order to meet this peak gain requirement.

REVISION: A	ECR/ECN INFORMATION: EC No: DATE:	TITLE: 2.4GHz/5GHz Ceramic SMT antenna Application Specification	SHEET No. 4 of 26
DOCUMENT NUMBER: 2119640001	CREATED / REVISED BY: Liu Hai 2018/12/24	CHECKED BY: Cooper Zhou 2018/12/24	APPROVED BY: Chris Zhong 2018/12/24

4.3 RETURN LOSS PLOT

All measurements in this document are done on a reference PCB.

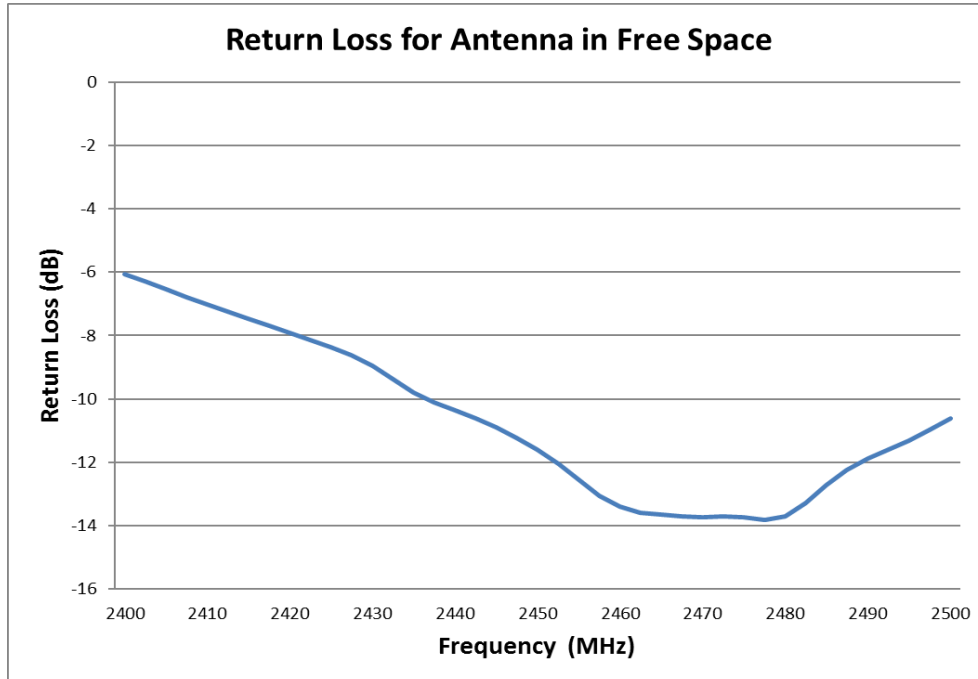

FIGURE 4.3.1 RETURN LOSS OF ANTENNA AT 2.4GHZ IN FREE SPACE FOR CONFIGURE 1

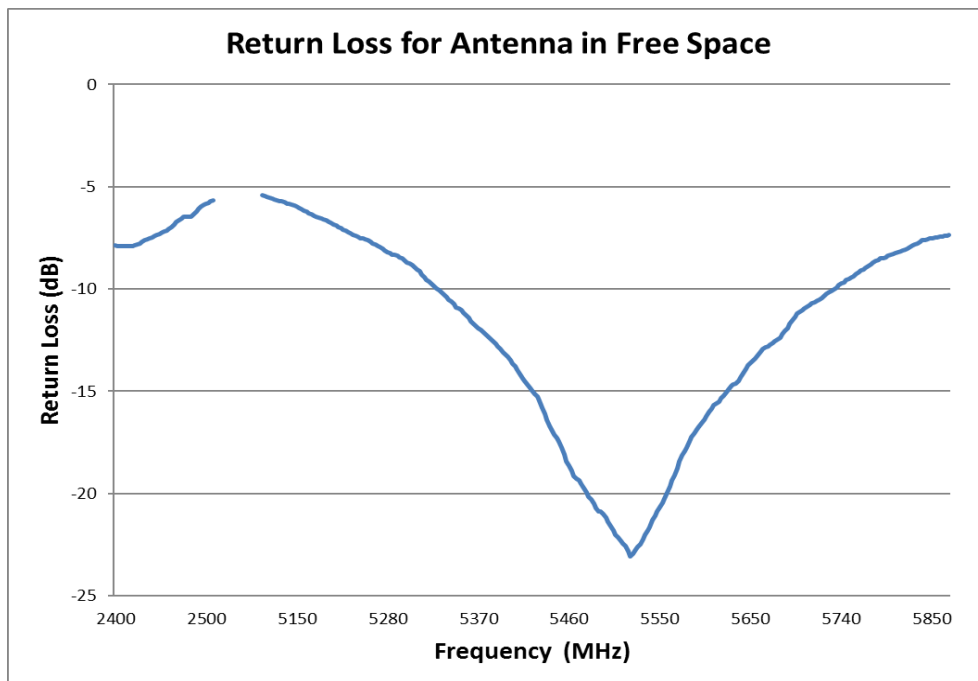

FIGURE 4.3.2 RETURN LOSS OF ANTENNA AT 2.4/5GHZ IN FREE SPACE FOR CONFIGURE 2

REVISION: A	ECR/ECN INFORMATION: EC No: DATE:	TITLE: 2.4GHz/5GHz Ceramic SMT antenna Application Specification	SHEET No. 5 of 26
DOCUMENT NUMBER: 2119640001	CREATED / REVISED BY: Liu Hai 2018/12/24	CHECKED BY: Cooper Zhou 2018/12/24	APPROVED BY: Chris Zhong 2018/12/24

4.4 EFFICIENCY PLOT

All measurements in this document are done on a reference PCB.

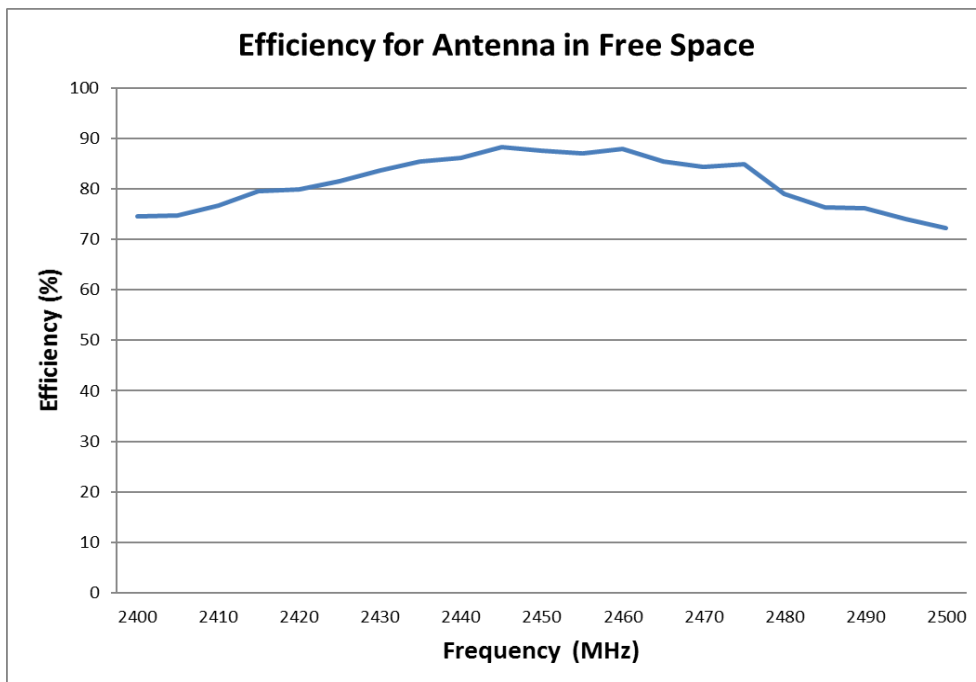

FIGURE 4.4.1 EFFICIENCY OF ANTENNA AT 2.4GHZ IN FREE SPACE FOR CONFIGURE 1

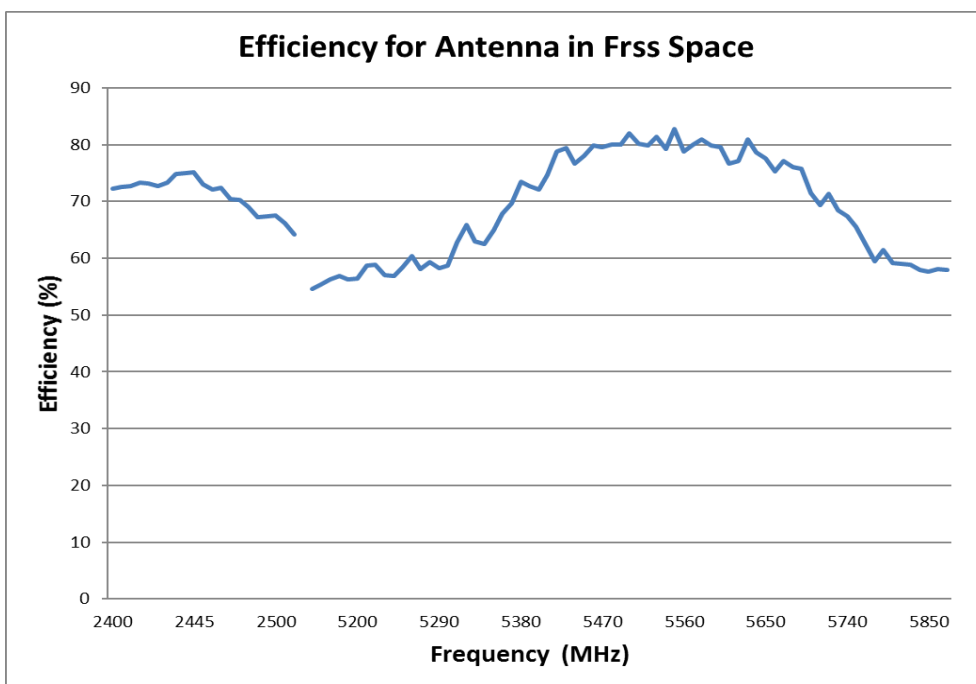
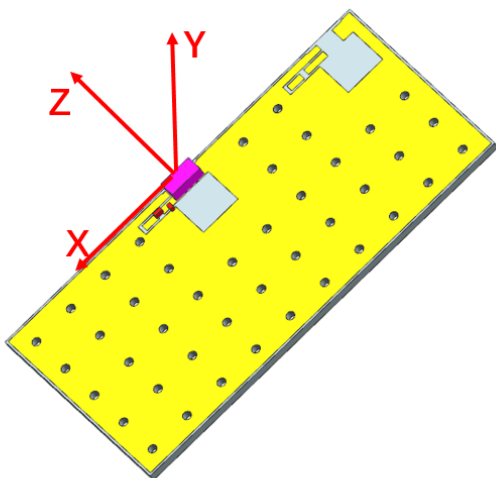

FIGURE 4.4.2 EFFICIENCY OF ANTENNA AT 2.4/5GHZ IN FREE SPACE FOR CONFIGURE 2

REVISION: A	ECR/ECN INFORMATION: EC No: DATE:	TITLE: 2.4GHz/5GHz Ceramic SMT antenna Application Specification	SHEET No. 6 of 26
DOCUMENT NUMBER: 2119640001	CREATED / REVISED BY: Liu Hai 2018/12/24	CHECKED BY: Cooper Zhou 2018/12/24	APPROVED BY: Chris Zhong 2018/12/24

4.5 2D RADIATION PATTERN

All measurements in this document are done on a reference PCB.



XY-2450MHz

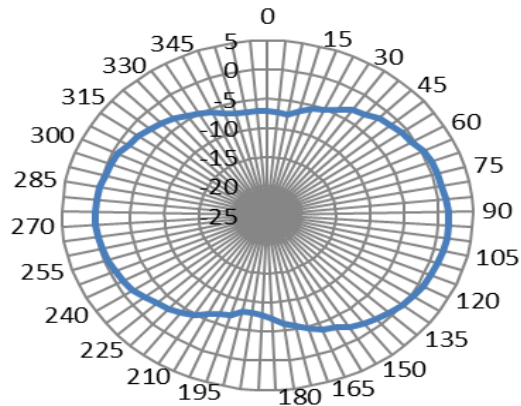

XZ-2450MHz

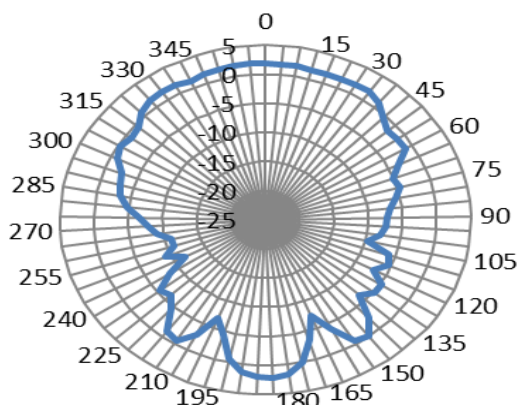

YZ-2450MHz

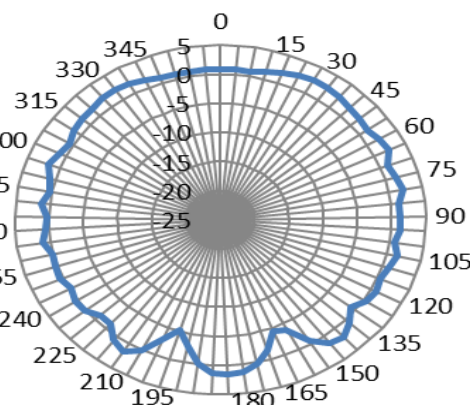
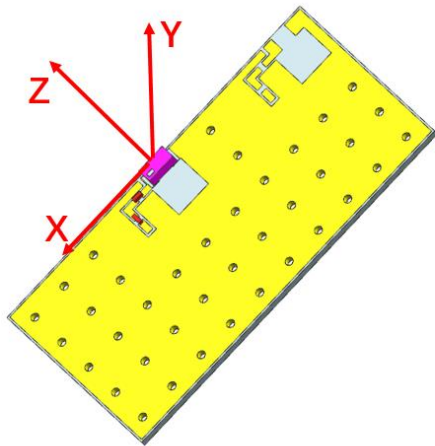
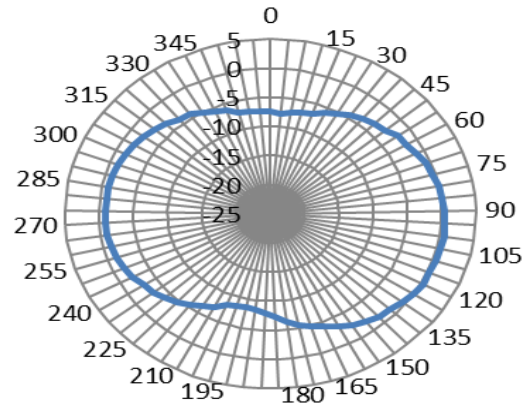

FIGURE 4.5.1 2D RADIATION PATTERN OF ANTENNA AT 2.4GHZ IN FREE SPACE FOR CONFIGURE 1

REVISION: A	ECR/ECN INFORMATION: EC No: DATE:	TITLE: 2.4GHz/5GHz Ceramic SMT antenna Application Specification	SHEET No. 7 of 26
DOCUMENT NUMBER: 2119640001	CREATED / REVISED BY: Liu Hai 2018/12/24	CHECKED BY: Cooper Zhou 2018/12/24	APPROVED BY: Chris Zhong 2018/12/24



XY-2450MHz



XZ-2450MHz

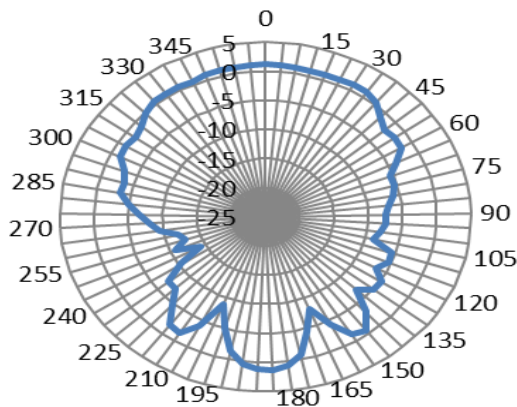

YZ-2450MHz

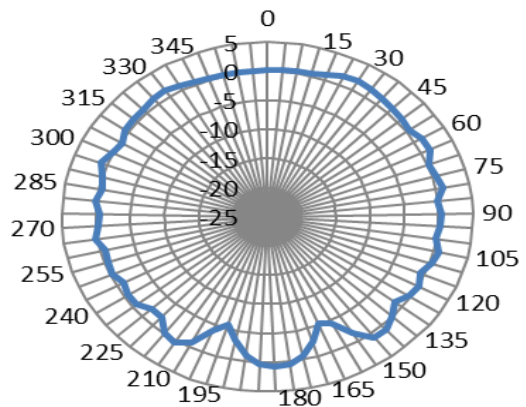
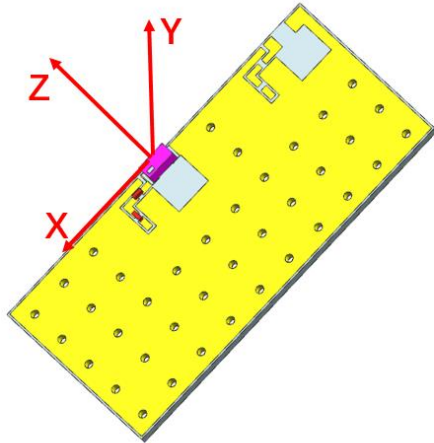
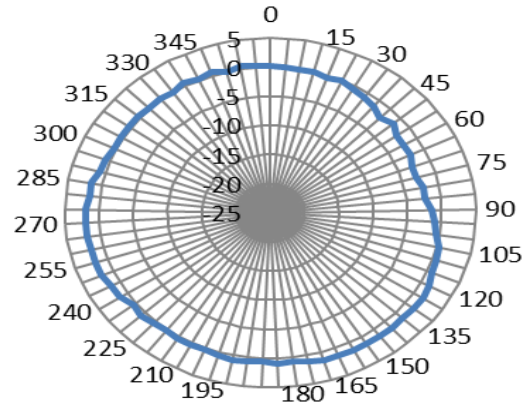

FIGURE 4.5.2 2D RADIATION PATTERN OF ANTENNA AT 2.4GHZ IN FREE SPACE FOR CONFIGURE 2

REVISION: A	ECR/ECN INFORMATION: EC No: DATE:	TITLE: 2.4GHz/5GHz Ceramic SMT antenna Application Specification	SHEET No. 8 of 26
DOCUMENT NUMBER: 2119640001	CREATED / REVISED BY: Liu Hai 2018/12/24	CHECKED BY: Cooper Zhou 2018/12/24	APPROVED BY: Chris Zhong 2018/12/24



XY-5500MHz



XZ-5500MHz

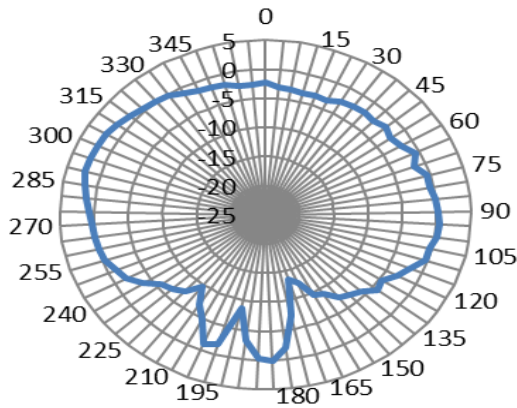

YZ-5500MHz

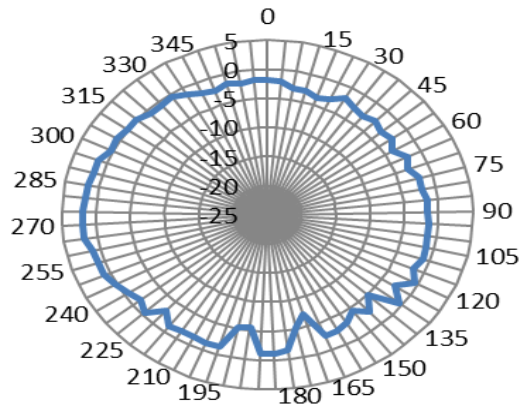

FIGURE 4.5.3 2D RADIATION PATTERN OF ANTENNA AT 5.5GHZ IN FREE SPACE FOR CONFIGURE 2

REVISION: A	ECR/ECN INFORMATION: EC No: DATE:	TITLE: 2.4GHz/5GHz Ceramic SMT antenna Application Specification	SHEET No. 9 of 26
DOCUMENT NUMBER: 2119640001	CREATED / REVISED BY: Liu Hai 2018/12/24	CHECKED BY: Cooper Zhou 2018/12/24	APPROVED BY: Chris Zhong 2018/12/24

4.6 3D RADIATION PATTERN

All measurements in this document are done on a reference PCB.

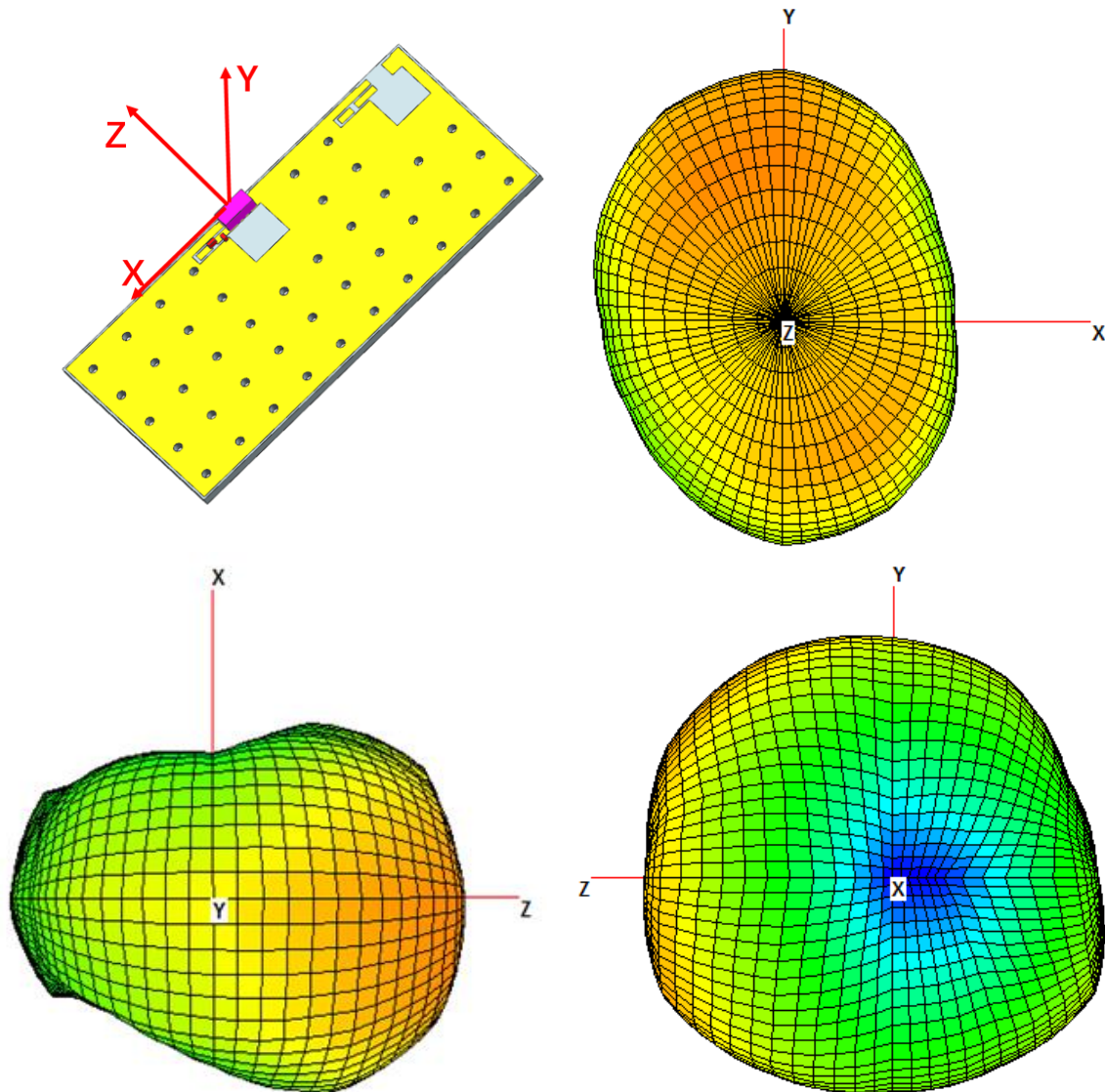

FIGURE 4.6.1 3D RADIATION PATTERN OF ANTENNA AT 2450GHZ IN FREE SPACE FOR CONFIGURE 1

REVISION: A	ECR/ECN INFORMATION: EC No: DATE:	TITLE: 2.4GHz/5GHz Ceramic SMT antenna Application Specification	SHEET No. 10 of 26
DOCUMENT NUMBER: 2119640001	CREATED / REVISED BY: Liu Hai 2018/12/24	CHECKED BY: Cooper Zhou 2018/12/24	APPROVED BY: Chris Zhong 2018/12/24

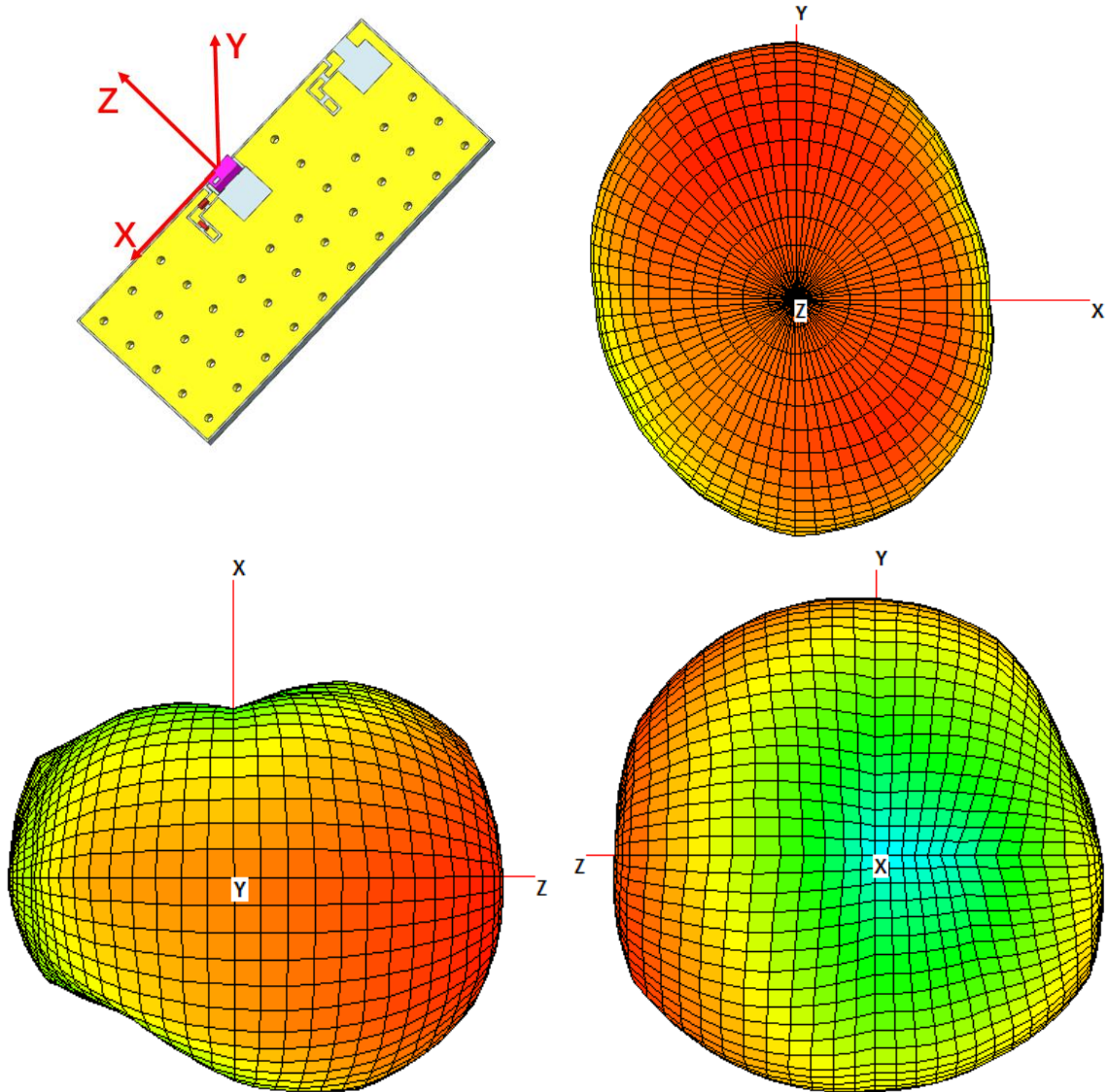

FIGURE 4.6.2 3D RADIATION PATTERN OF ANTENNA AT 2450MHZ IN FREE SPACE FOR CONFIGURE 2

REVISION: A	ECR/ECN INFORMATION: EC No: DATE:	TITLE: 2.4GHz/5GHz Ceramic SMT antenna Application Specification	SHEET No. 11 of 26
DOCUMENT NUMBER: 2119640001	CREATED / REVISED BY: Liu Hai 2018/12/24	CHECKED BY: Cooper Zhou 2018/12/24	APPROVED BY: Chris Zhong 2018/12/24

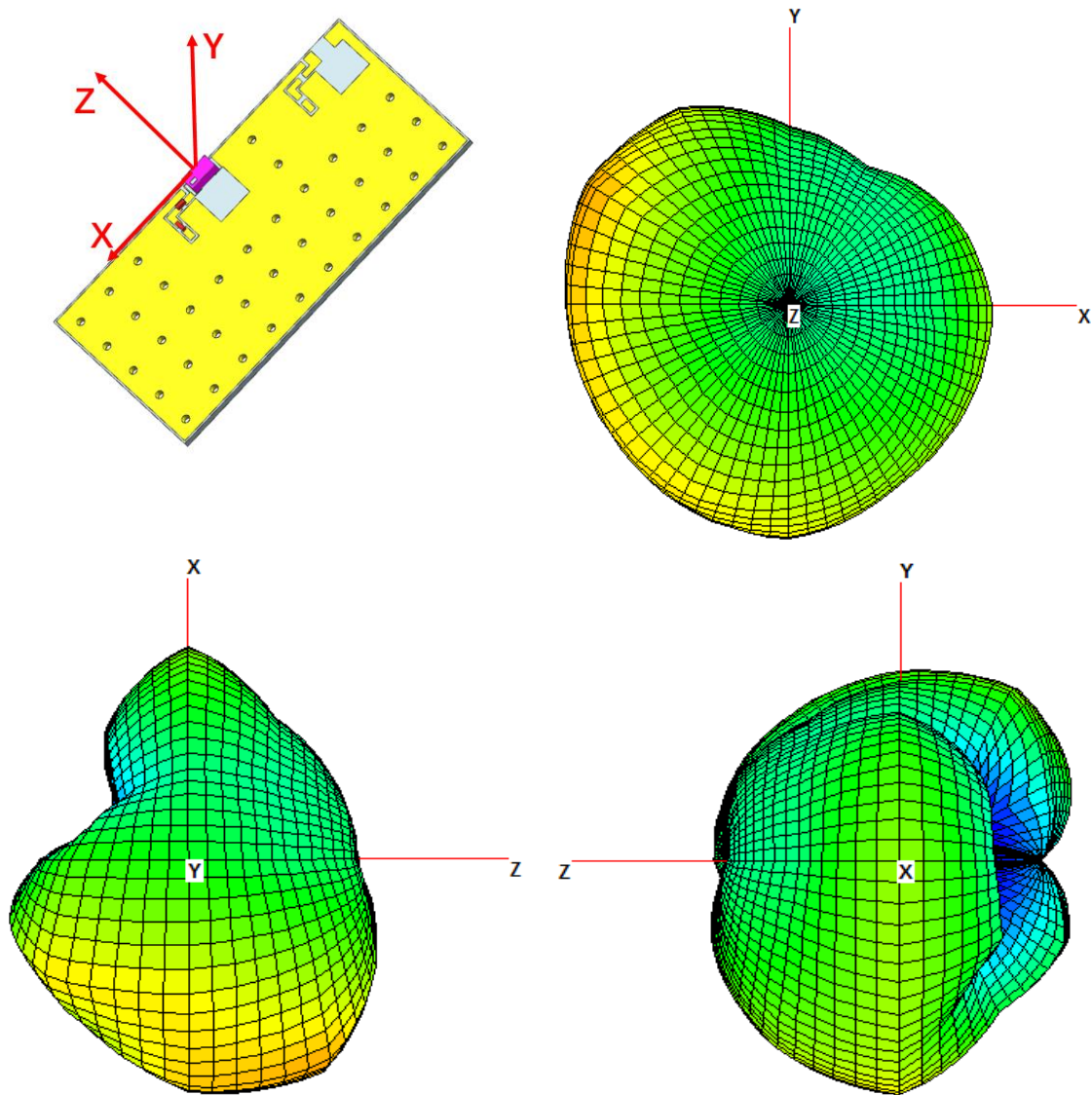

FIGURE 4.6.3 3D RADIATION PATTERN OF ANTENNA AT 5500MHZ IN FREE SPACE FOR CONFIGURE 2

REVISION: A	ECR/ECN INFORMATION: EC No: DATE:	TITLE: 2.4GHz/5GHz Ceramic SMT antenna Application Specification	SHEET No. 12 of 26
DOCUMENT NUMBER: 2119640001	CREATED / REVISED BY: Liu Hai 2018/12/24	CHECKED BY: Cooper Zhou 2018/12/24	APPROVED BY: Chris Zhong 2018/12/24

5.0 MATCHING NETWORK DESCRIPTION

The recommended matching network shown in Figure 5.1-5.2.

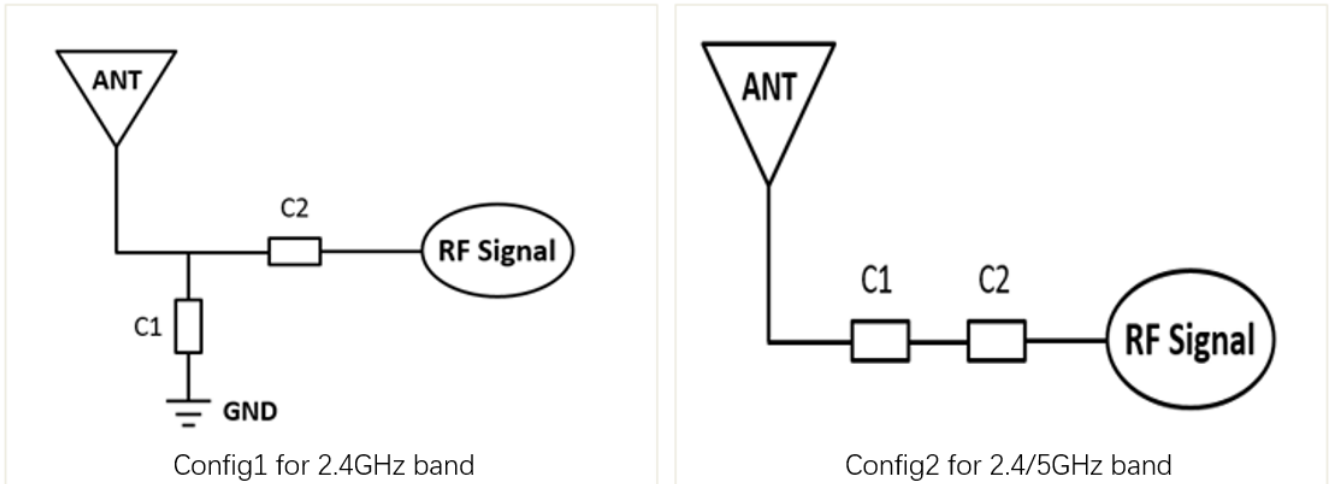
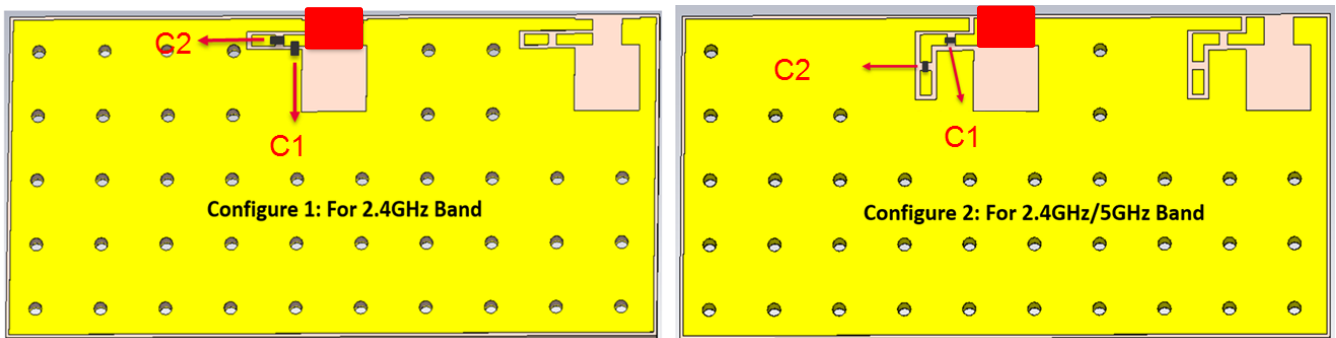

FIGURE 5.1 RECOMMENDED MATCHING CIRCUIT SCHEMATIC FOR CONFIGURE 1 AND CONFIGURE 2



Component	Configure 1	Configure 2
C1	2.7pF	4.7nH
	Murata (PN: GRM1555C1H2R7WA01)	Murata (PN: LQW15AN4N7B00)
C2	0Ω	0.6pF
		Murata (PN: GRM1555C1HR60BA01D)

FIGURE 5.2 RECOMMENDED MATCHING CIRCUIT FOR CONFIGURE 1 AND CONFIGURE 2

REVISION: A	ECR/ECN INFORMATION: EC No: DATE:	TITLE: 2.4GHz/5GHz Ceramic SMT antenna Application Specification	SHEET No. 13 of 26
DOCUMENT NUMBER: 2119640001	CREATED / REVISED BY: Liu Hai 2018/12/24	CHECKED BY: Cooper Zhou 2018/12/24	APPROVED BY: Chris Zhong 2018/12/24



APPLICATION SPECIFICATION

6.0 RECOMMENDED REFLOW CONDITION

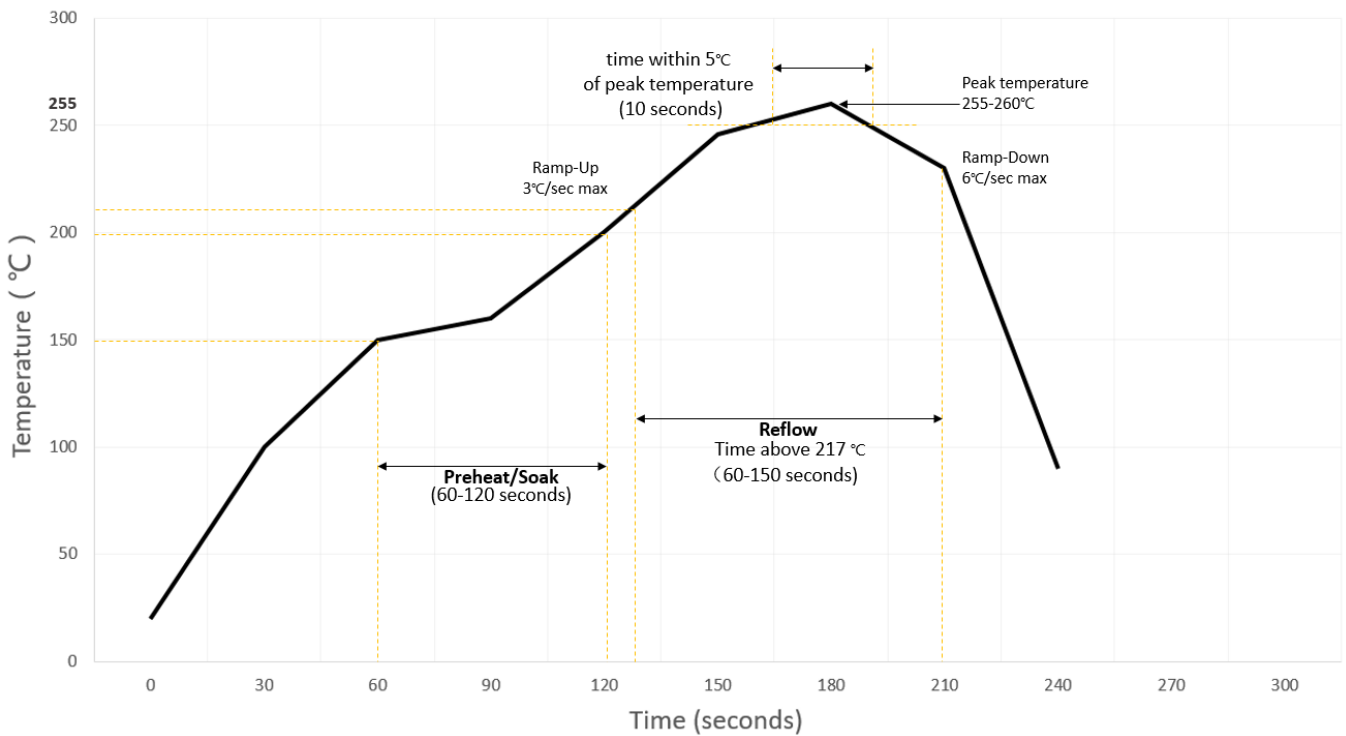

Recommended solder paste: ALPHA CAP-390 SAC305;

Recommended stencil thickness: $0.1\text{MM} \leq T \leq 0.15\text{MM}$;

For mechanically challenging applications. Molex recommends using surface mount glue (e.g. Loctite 3611) before reflow soldering process to ensure increased mechanical retention on the PCB.

REVISION: A	ECR/ECN INFORMATION: EC No: DATE:	TITLE: 2.4GHz/5GHz Ceramic SMT antenna Application Specification	SHEET No. 14 of 26
DOCUMENT NUMBER: 2119640001	CREATED / REVISED BY: Liu Hai 2018/12/24	CHECKED BY: Cooper Zhou 2018/12/24	APPROVED BY: Chris Zhong 2018/12/24

7.0 RF PERFORMANCE AS A FUNCTION OF IMPLEMENTATION

All measurements in this document are done on a reference PCB.

7.1 ANTENNA RF PERFORMANCE AS A FUNCTION OF DIFFERENT LOCATIONS WITH PARALLEL PLANE GROUND FOR CONFIGURE 1 AND CONFIGURE 2

Four locations with parallel plane ground have been evaluated and the location presentation is shown in figure 7.1. The plane ground size is 60mm*30mm and we move the plane ground to four locations for each test.

The antenna performance is better with larger distance between antenna and parallel plane ground. The minimum distance between antenna and plane ground is recommended to be 10mm to achieve acceptable RF performance for configure 1.

The minimum distance between antenna and plane ground is recommended to be 5mm to achieve acceptable RF performance for configure 2.

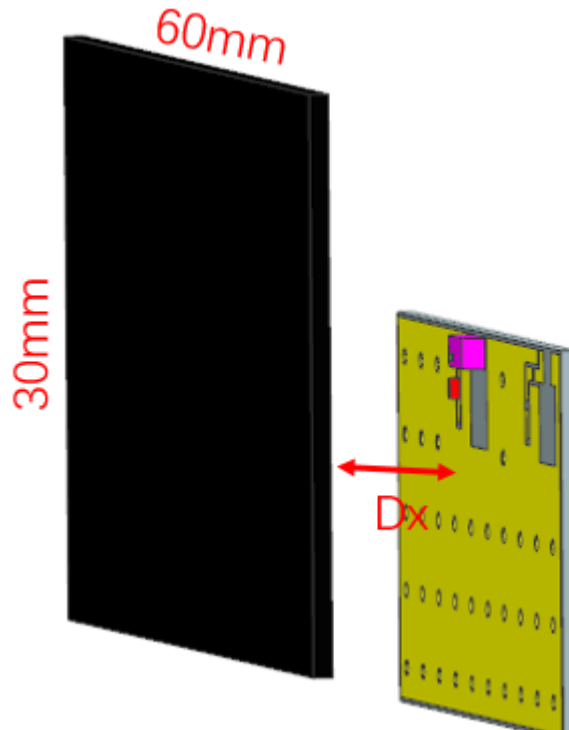

FIGURE 7.1 FOUR LOCATIONS WITH PARALLEL PLANE GROUND (USING CONFIG1 FOR ILLUSTRATION)

Ground Size: 60mm*30mm;

Location D1: Distance between antenna and plane ground is about 5mm;

Location D2: Distance between antenna and plane ground is about 10mm;

Location D3: Distance between antenna and plane ground is about 15mm;

Location D4: Distance between antenna and plane ground is about 20mm

REVISION: A	ECR/ECN INFORMATION: EC No: DATE:	TITLE: 2.4GHz/5GHz Ceramic SMT antenna Application Specification	SHEET No. 15 of 26
DOCUMENT NUMBER: 2119640001	CREATED / REVISED BY: Liu Hai 2018/12/24	CHECKED BY: Cooper Zhou 2018/12/24	APPROVED BY: Chris Zhong 2018/12/24

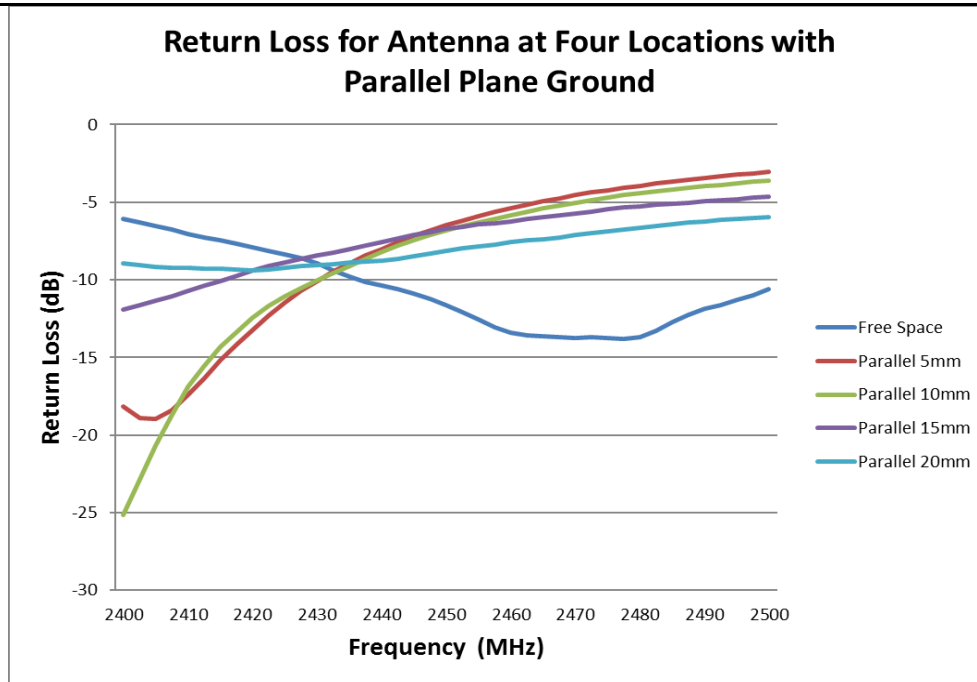

FIGURE 7.1.1 RETURN LOSS OF ANTENNA AT 2.4GHZ AT FOUR LOCATIONS WITH PARALLEL PLANE GROUND ON A REFERENCE PCB FOR CONFIGURE 1

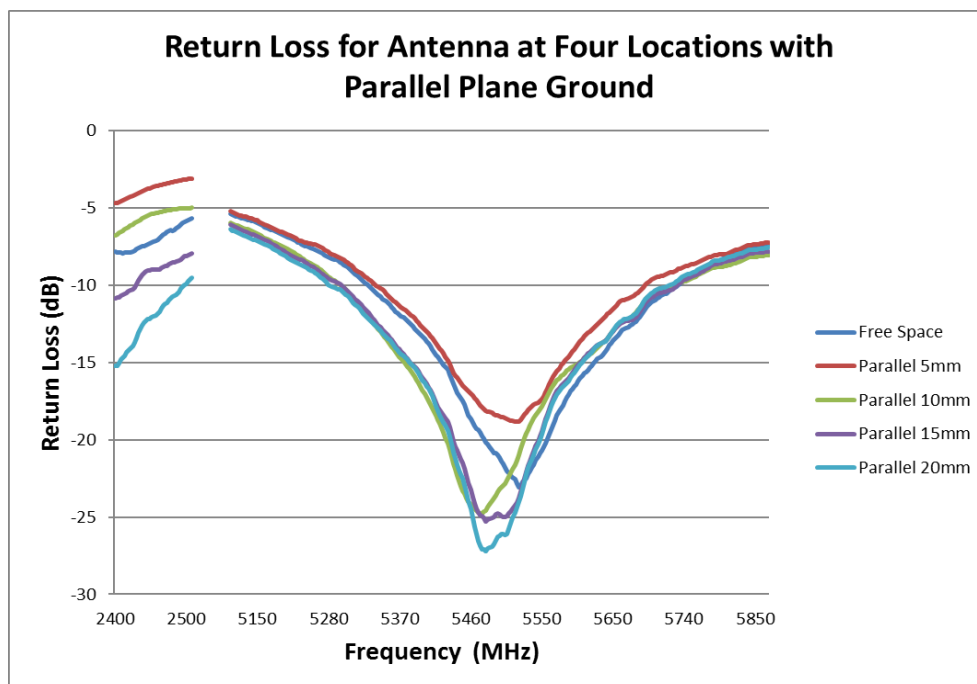

FIGURE 7.1.2 RETURN LOSS OF ANTENNA AT 2.4/5GHZ AT FOUR LOCATIONS WITH PARALLEL PLANE GROUND ON A REFERENCE PCB FOR CONFIGURE 2

REVISION: A	ECR/ECN INFORMATION: EC No: DATE:	TITLE: 2.4GHz/5GHz Ceramic SMT antenna Application Specification	SHEET No. 16 of 26
DOCUMENT NUMBER: 2119640001	CREATED / REVISED BY: Liu Hai 2018/12/24	CHECKED BY: Cooper Zhou 2018/12/24	APPROVED BY: Chris Zhong 2018/12/24

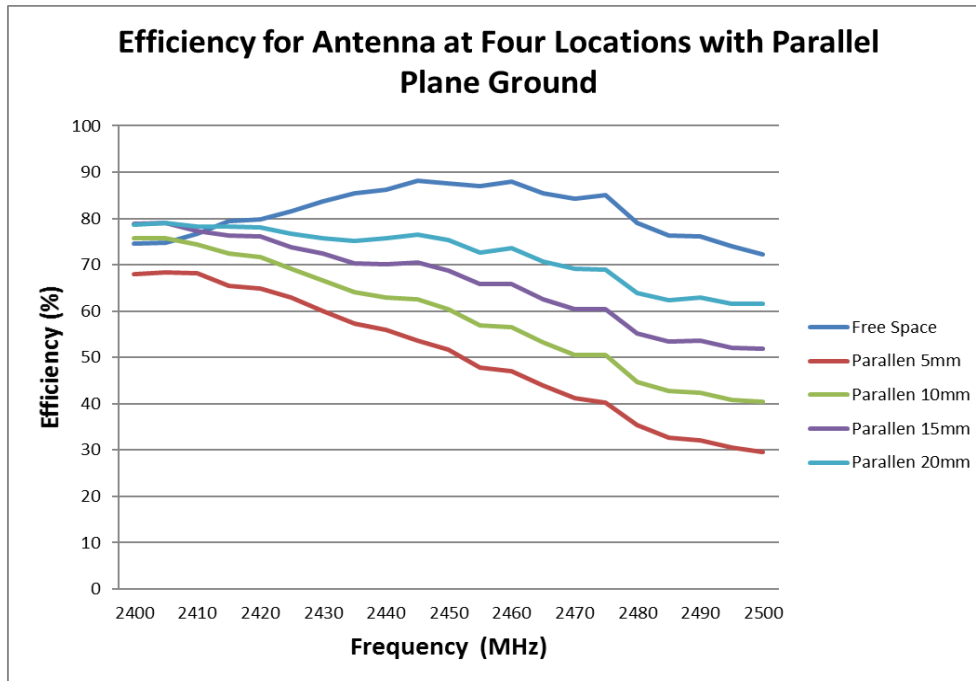

FIGURE 7.1.3 EFFICIENCY OF ANTENNA AT 2.4GHZ AT FOUR LOCATIONS WITH PARALLEL PLANE GROUND ON A REFERENCE PCB FOR CONFIGURE 1

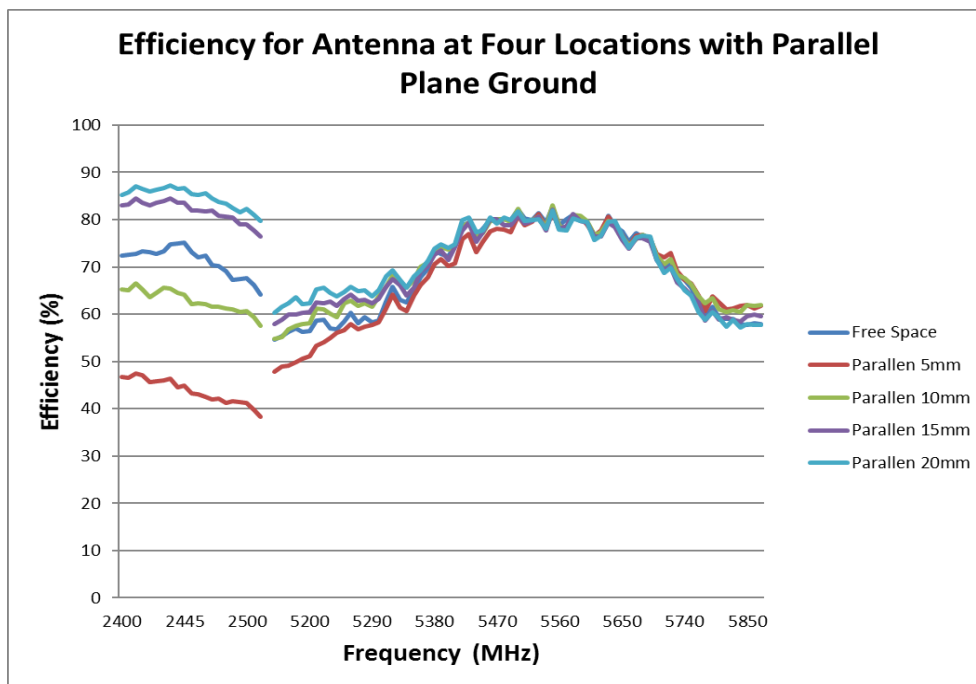

FIGURE 7.1.4 EFFICIENCY OF ANTENNA AT 2.4/5GHZ AT FOUR LOCATIONS WITH PARALLEL PLANE GROUND ON A REFERENCE PCB FOR CONFIGURE 2

REVISION: A	ECR/ECN INFORMATION: EC No: DATE:	TITLE: 2.4GHz/5GHz Ceramic SMT antenna Application Specification	SHEET No. 17 of 26
DOCUMENT NUMBER: 2119640001	CREATED / REVISED BY: Liu Hai 2018/12/24	CHECKED BY: Cooper Zhou 2018/12/24	APPROVED BY: Chris Zhong 2018/12/24

7.2 ANTENNA RF PERFORMANCE AS A FUNCTION OF DIFFERENT LOCATIONS WITH VERTICAL PLANE GROUND FOR CONFIGURE 1 AND CONFIGURE 2

Four locations with vertical plane ground have been evaluated and the location presentation is shown in figure 7.2. The plane ground size is 60*30mm and we move the plane ground to four locations for each test.

The distance between antenna and vertical plane ground affect the antenna performance slightly. The minimum distance between antenna and plane ground is recommended to be 10mm to achieve acceptable RF performance for configure 1.

The minimum distance between antenna and plane ground is recommended to be 5mm to achieve acceptable RF performance for configure 2.

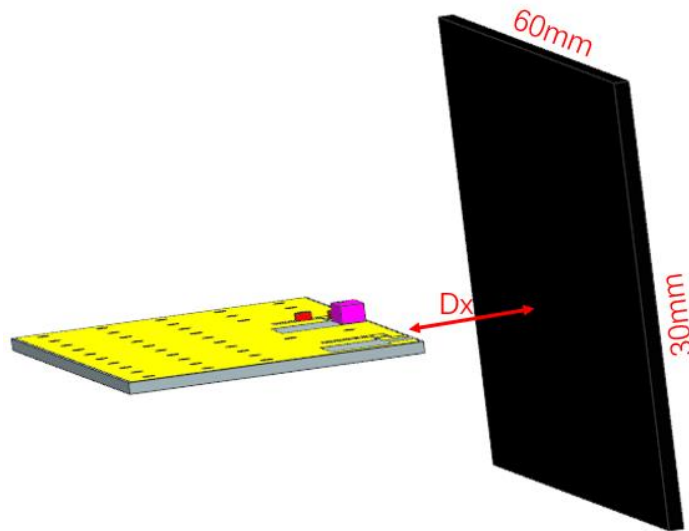

FIGURE 7.2 FOUR LOCATIONS WITH VERTICAL PLANE GROUND (USING CONFIG1 FOR ILLUSTRATION)

Ground Size: 60mm*30mm;

Location D1: Distance between antenna and plane ground is about 5mm;

Location D2: Distance between antenna and plane ground is about 10mm;

Location D3: Distance between antenna and plane ground is about 15mm;

Location D4: Distance between antenna and plane ground is about 20mm.

REVISION: A	ECR/ECN INFORMATION: EC No: DATE:	TITLE: 2.4GHz/5GHz Ceramic SMT antenna Application Specification	SHEET No. 18 of 26
DOCUMENT NUMBER: 2119640001	CREATED / REVISED BY: Liu Hai 2018/12/24	CHECKED BY: Cooper Zhou 2018/12/24	APPROVED BY: Chris Zhong 2018/12/24

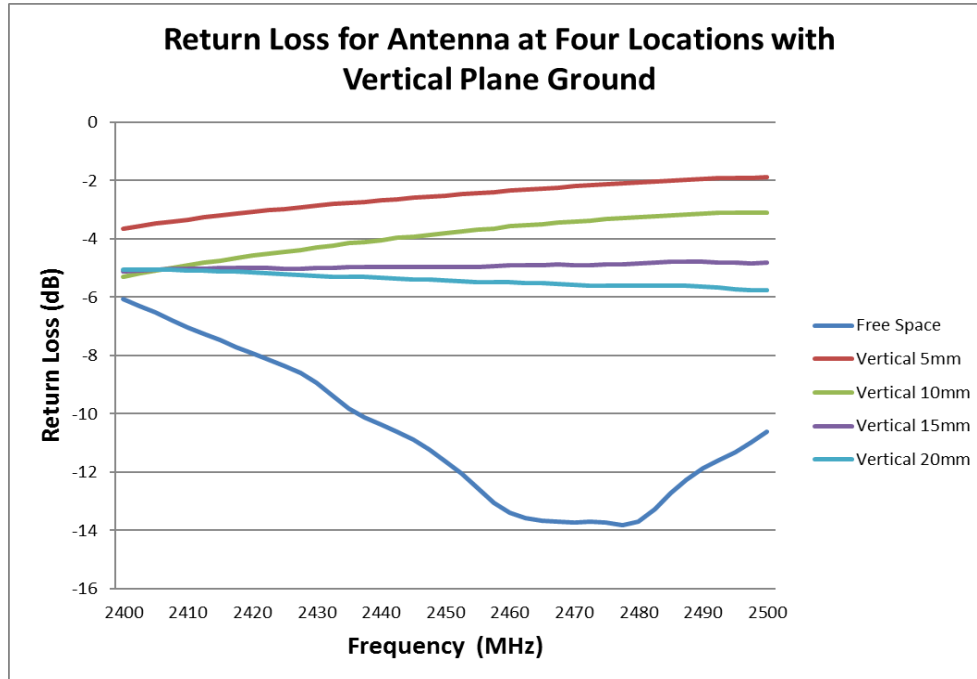

FIGURE 7.2.1 RETURN LOSS OF ANTENNA AT 2.4GHZ AT FOUR LOCATIONS WITH VERTICAL PLANE GROUND ON A REFERENCE PCB FOR CONFIGURE 1

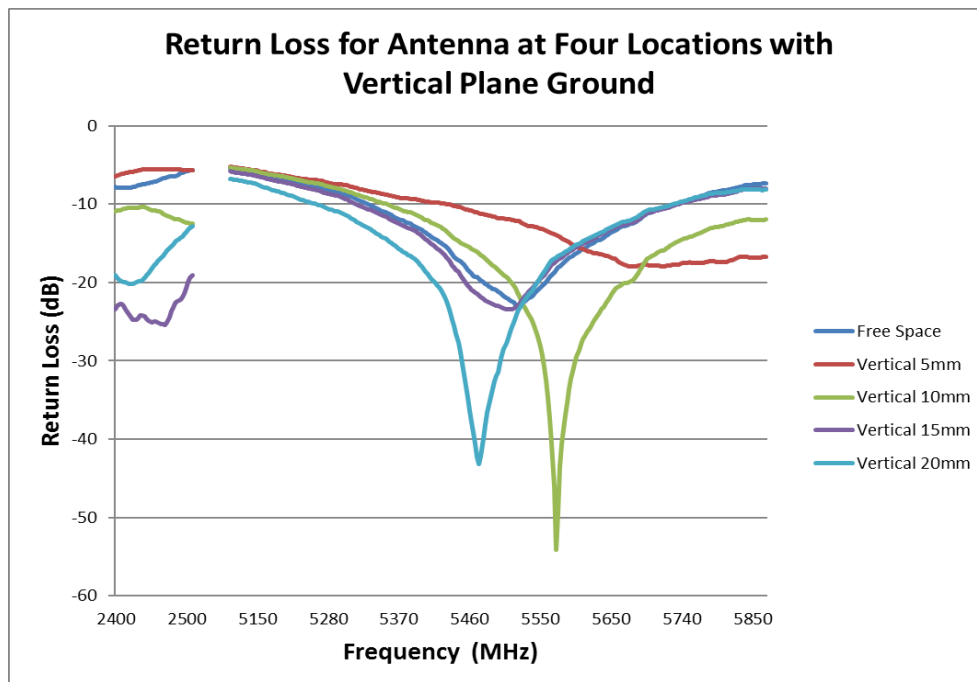

FIGURE 7.2.2 RETURN LOSS OF ANTENNA AT 2.4/5GHZ AT FOUR LOCATIONS WITH VERTICAL PLANE GROUND ON A REFERENCE PCB FOR CONFIGURE 2

REVISION: A	ECR/ECN INFORMATION: EC No: DATE:	TITLE: 2.4GHz/5GHz Ceramic SMT antenna Application Specification	SHEET No. 19 of 26
DOCUMENT NUMBER: 2119640001	CREATED / REVISED BY: Liu Hai 2018/12/24	CHECKED BY: Cooper Zhou 2018/12/24	APPROVED BY: Chris Zhong 2018/12/24

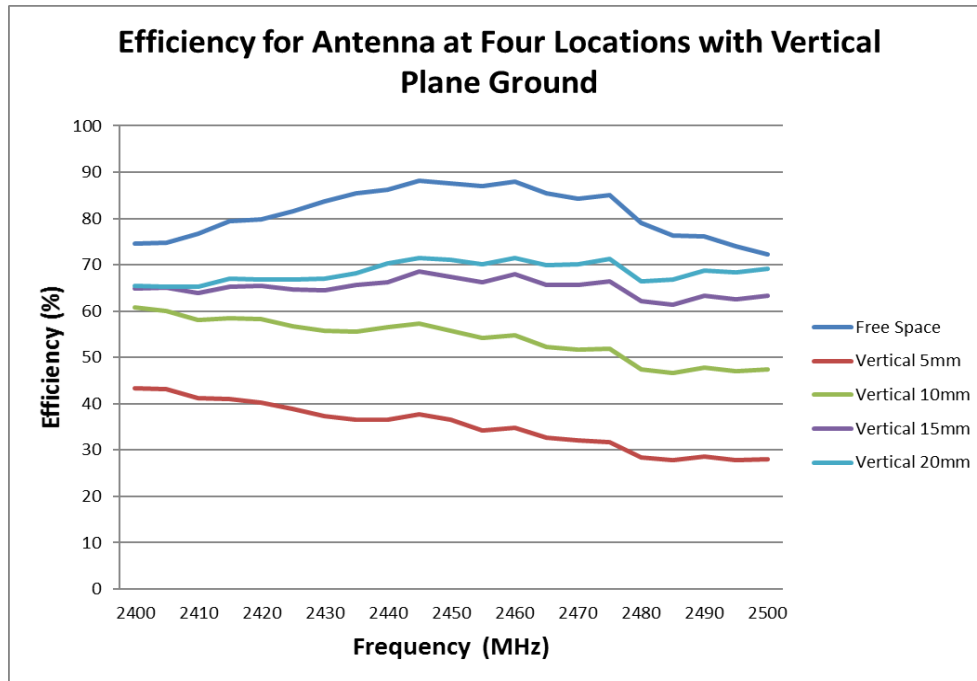

FIGURE 7.2.3 EFFICIENCY OF ANTENNA AT 2.4GHZ AT FOUR LOCATIONS WITH VERTICAL PLANE GROUND ON A REFERENCE PCB FOR CONFIGURE 1

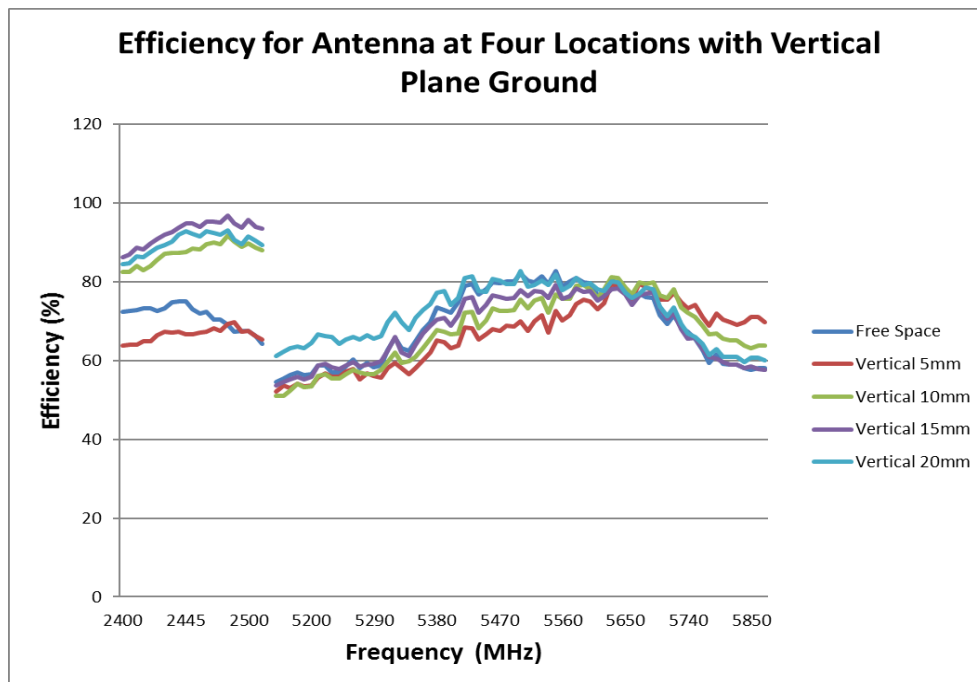

FIGURE 7.2.4 EFFICIENCY OF ANTENNA AT 2.4/5GHZ AT FOUR LOCATIONS WITH VERTICAL PLANE GROUND ON A REFERENCE PCB FOR CONFIGURE 2

REVISION: A	ECR/ECN INFORMATION: EC No: DATE:	TITLE: 2.4GHz/5GHz Ceramic SMT antenna Application Specification	SHEET No. 20 of 26
DOCUMENT NUMBER: 2119640001	CREATED / REVISED BY: Liu Hai 2018/12/24	CHECKED BY: Cooper Zhou 2018/12/24	APPROVED BY: Chris Zhong 2018/12/24

7.3 ANTENNA RF PERFORMANCE AS A FUNCTION OF LOCATIONS ON REFERENCE PCB FOR CONFIGURE 1 AND CONFIGURE 2

Two locations have been evaluated RF performance and these locations are shown in figure 7.3. Figure 7.3.1, figure 7.3.2, figure 7.3.3 and figure 7.3.4 comparatively present the return loss and efficiency at two locations.

The performance of location 1 is much better than location 2. So the location 1 (upper center location) is the recommended location for this antenna.

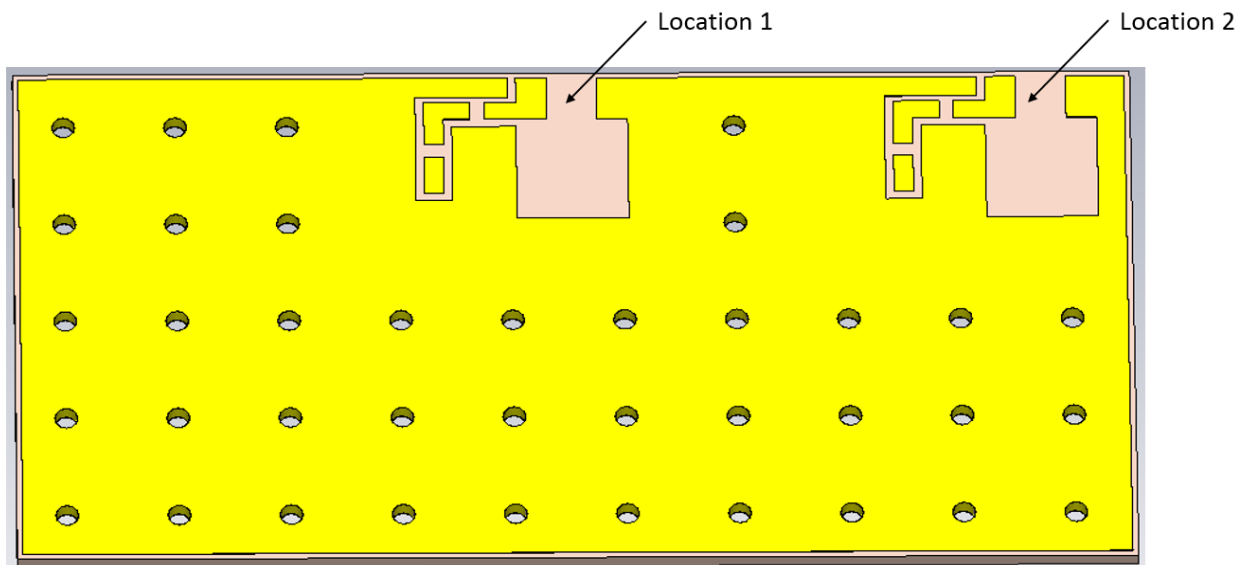

FIGURE 7.3 TWO LOCATIONS ON REFERENCE PCB FOR CONFIGURE 1 AND CONFIGURE 2(USING CONFIG1 FOR ILLUSTRATION)

REVISION: A	ECR/ECN INFORMATION: EC No: DATE:	TITLE: 2.4GHz/5GHz Ceramic SMT antenna Application Specification	SHEET No. 21 of 26
DOCUMENT NUMBER: 2119640001	CREATED / REVISED BY: Liu Hai 2018/12/24	CHECKED BY: Cooper Zhou 2018/12/24	APPROVED BY: Chris Zhong 2018/12/24

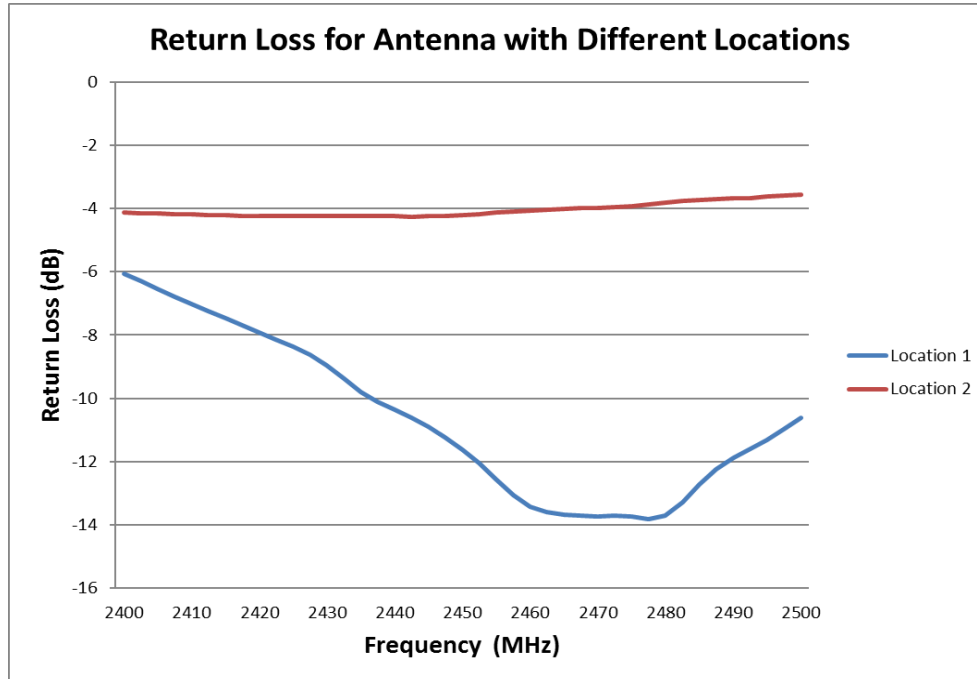

FIGURE 7.3.1 RETURN LOSS OF ANTENNA AT 2.4GHZ AT TWO DIFFERENT LOCATIONS FOR CONFIGURE 1

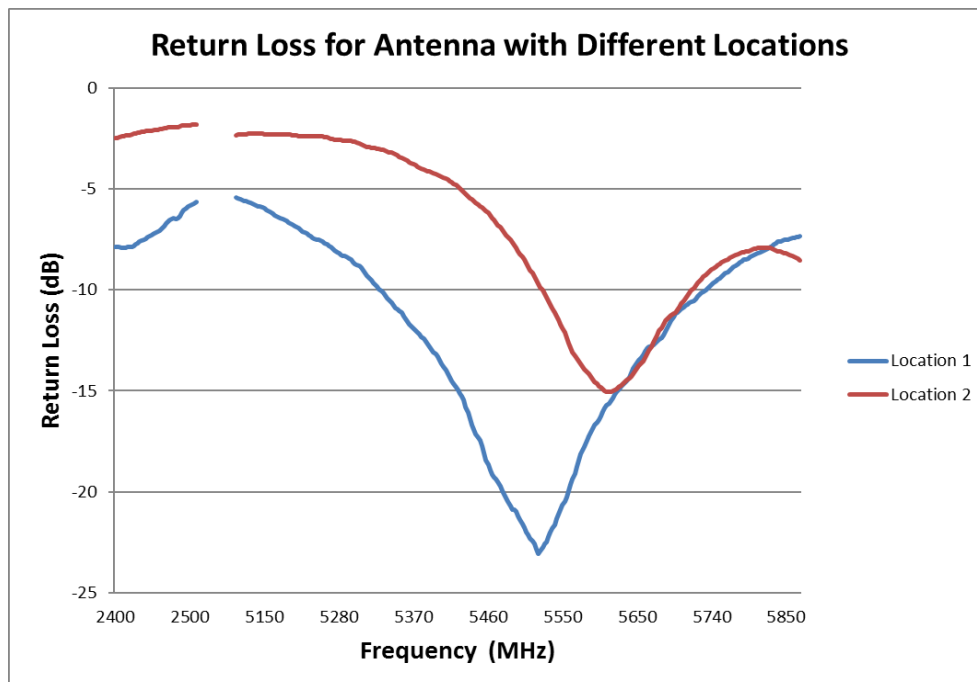

FIGURE 7.3.2 RETURN LOSS OF ANTENNA AT 2.4/5GHZ AT TWO DIFFERENT LOCATIONS FOR CONFIGURE 2

REVISION: A	ECR/ECN INFORMATION: EC No: DATE:	TITLE: 2.4GHz/5GHz Ceramic SMT antenna Application Specification	SHEET No. 22 of 26
DOCUMENT NUMBER: 2119640001	CREATED / REVISED BY: Liu Hai 2018/12/24	CHECKED BY: Cooper Zhou 2018/12/24	APPROVED BY: Chris Zhong 2018/12/24

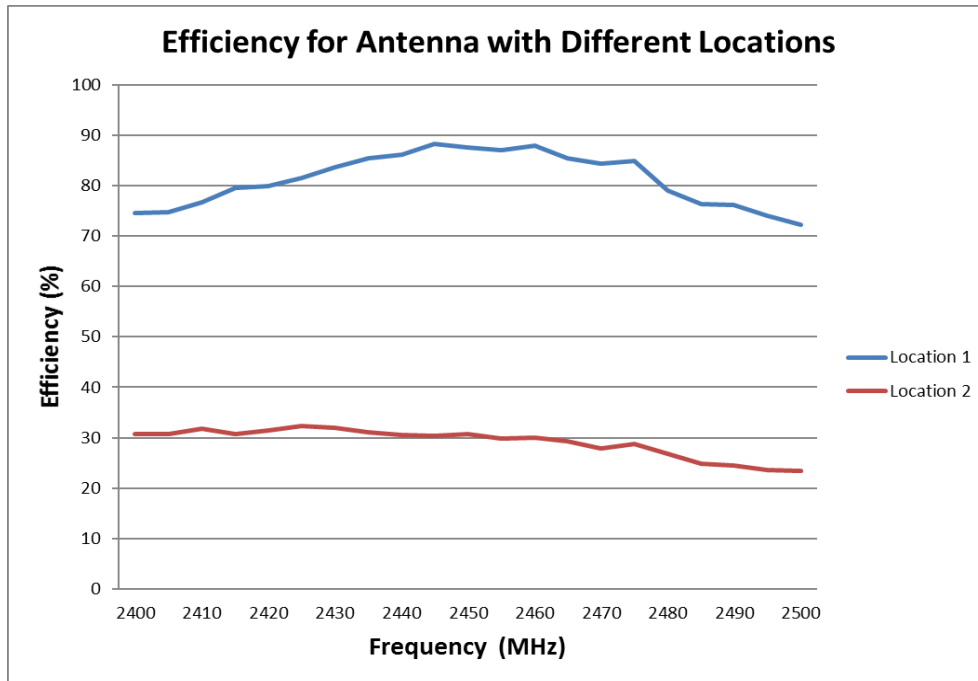

FIGURE 7.3.4 EFFICIENCY OF ANTENNA AT 2.4GHZ AT TWO DIFFERENT LOCATIONS FOR CONFIGURE 1

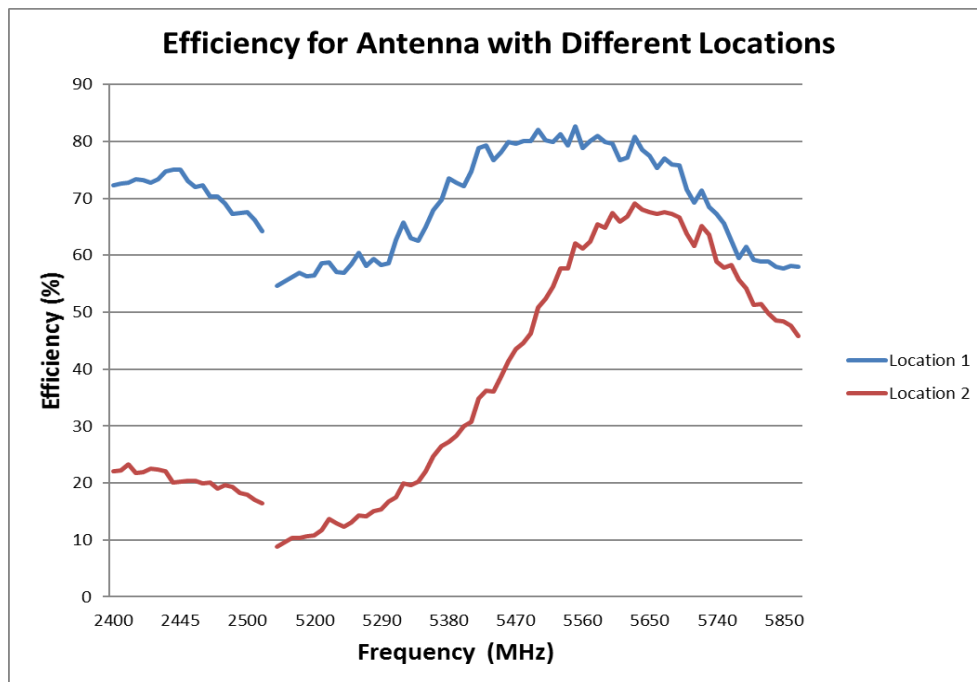

FIGURE 7.3.5 EFFICIENCY OF ANTENNA AT 2.4/5GHZ AT TWO DIFFERENT LOCCATIONS FOR CONFIGURE 2

REVISION: A	ECR/ECN INFORMATION: EC No: DATE:	TITLE: 2.4GHz/5GHz Ceramic SMT antenna Application Specification	SHEET No. 23 of 26
DOCUMENT NUMBER: 2119640001	CREATED / REVISED BY: Liu Hai 2018/12/24	CHECKED BY: Cooper Zhou 2018/12/24	APPROVED BY: Chris Zhong 2018/12/24

7.4 RF PERFORMANCE AS A FUNCTION ON DIFFERENT SIZE GROUD FOR CAONFIGURE 1 AND CONFIGURE 2

Three kinds of ground plane size were used for this study, which were 80mm*60mm, 60mm*40mm, and 40mm*20mm.

From the test result we can see the antenna performance is the best using reference PCB size

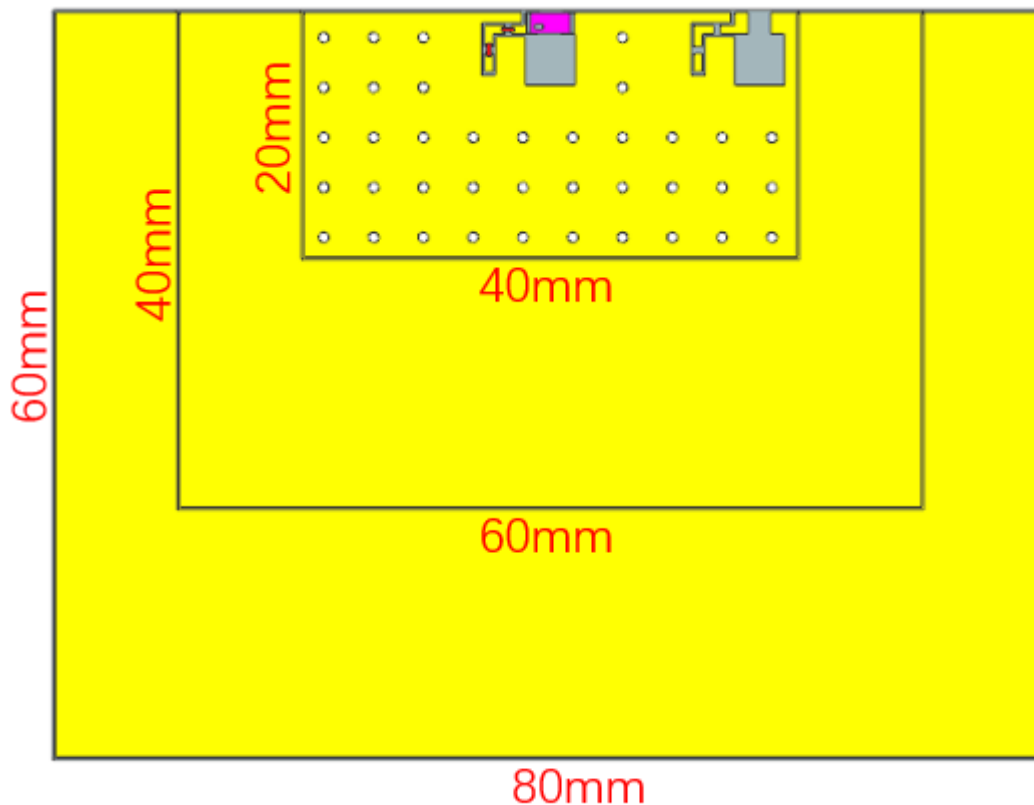

FIGURE 7.4 ANTENNA WITH DIFFERENT PLANE GROUNDS (USING CONFIG1 FOR ILLUSTRATION)

REVISION: A	ECR/ECN INFORMATION: EC No: DATE:	TITLE: 2.4GHz/5GHz Ceramic SMT antenna Application Specification	SHEET No. 24 of 26
DOCUMENT NUMBER: 2119640001	CREATED / REVISED BY: Liu Hai 2018/12/24	CHECKED BY: Cooper Zhou 2018/12/24	APPROVED BY: Chris Zhong 2018/12/24

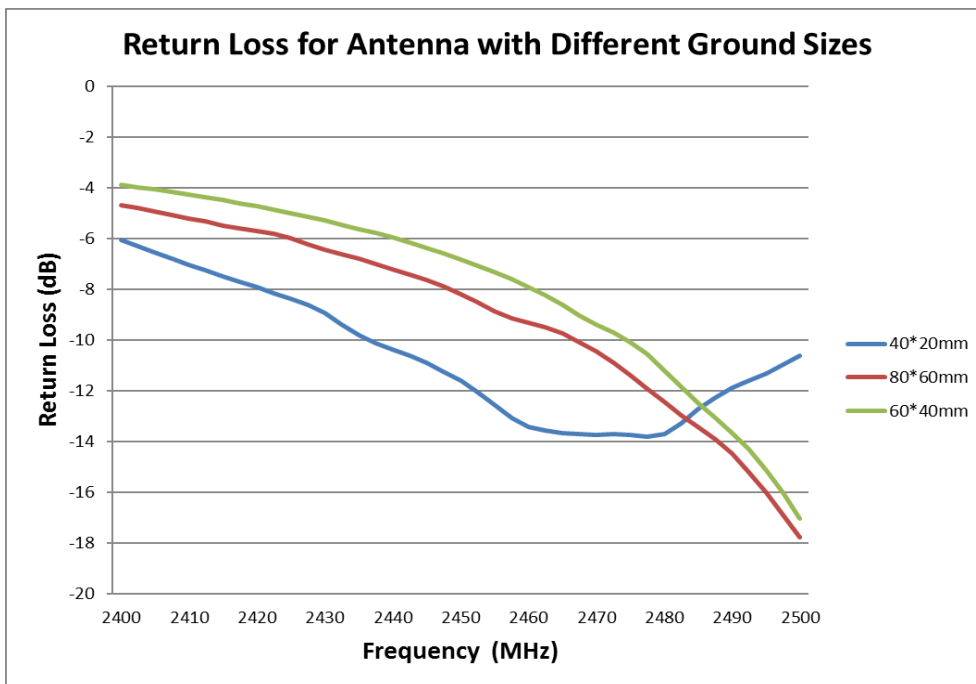

FIGURE 7.4.1 RETURN LOSS OF ANTENNA AT 2.4GHZ WITH DIFFERENT GROUND SIZES FOR CONFIGURE 1

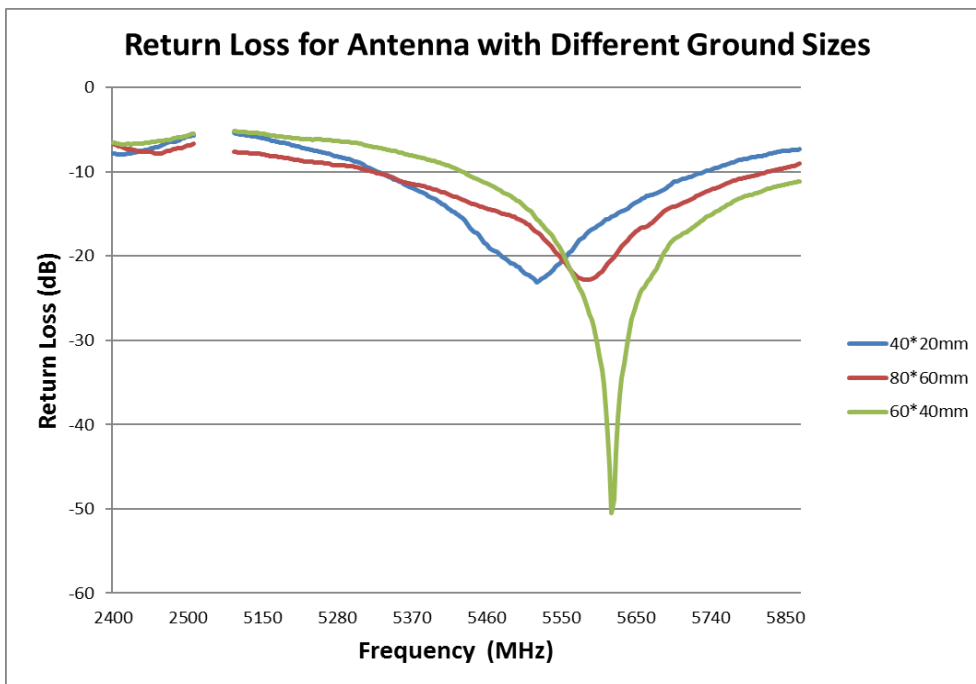

FIGURE 7.4.2 RETURN LOSS OF ANTENNA AT 2.4/5GHZ WITH DIFFERENT GROUND SIZES FOR CAONFIGURE 2

REVISION: A	ECR/ECN INFORMATION: EC No: DATE:	TITLE: 2.4GHz/5GHz Ceramic SMT antenna Application Specification	SHEET No. 25 of 26
DOCUMENT NUMBER: 2119640001	CREATED / REVISED BY: Liu Hai 2018/12/24	CHECKED BY: Cooper Zhou 2018/12/24	APPROVED BY: Chris Zhong 2018/12/24

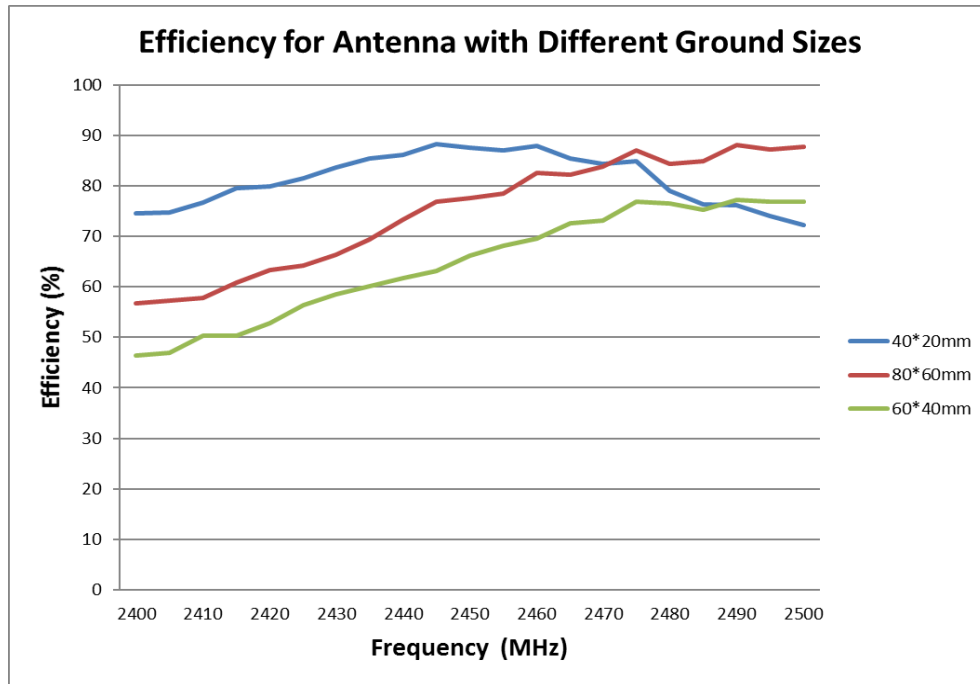

FIGURE 7.4.3 EFFICIENCY OF ANTENNA AT 2.4GHZ WITH DIFFERENT GROUND SIZES FOR CONFIGURE 1

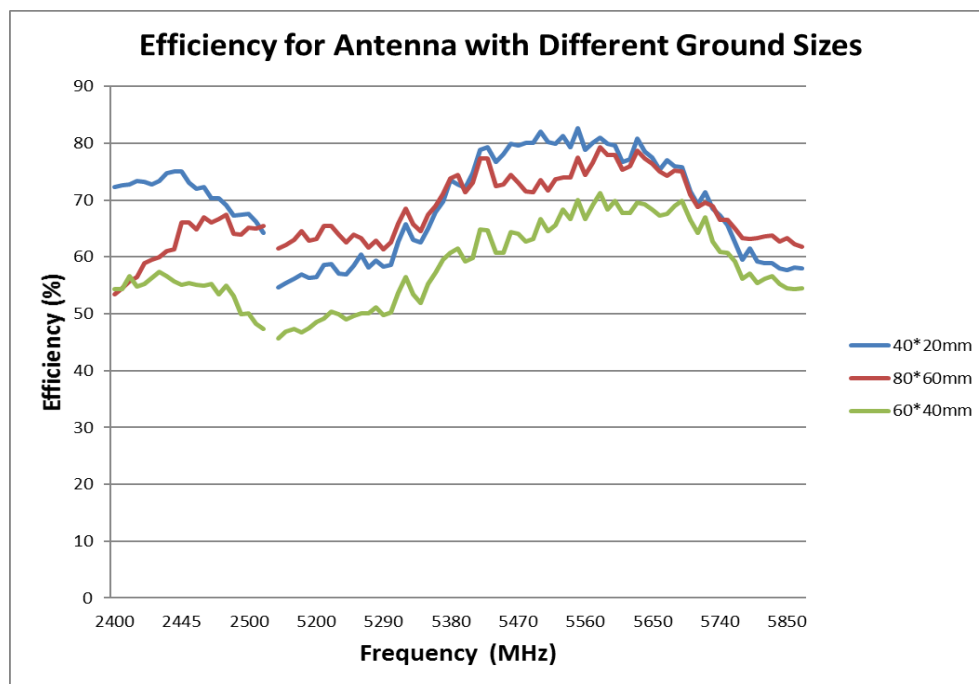

FIGURE 7.4.4 EFFICIENCY OF ANTENNA AT 2.4/5GHZ WITH DIFFERENT GROUND SIZES FOR CONFIGURE 2

REVISION: A	ECR/ECN INFORMATION: EC No: DATE:	TITLE: 2.4GHz/5GHz Ceramic SMT antenna Application Specification	SHEET No. 26 of 26
DOCUMENT NUMBER: 2119640001	CREATED / REVISED BY: Liu Hai 2018/12/24	CHECKED BY: Cooper Zhou 2018/12/24	APPROVED BY: Chris Zhong 2018/12/24