

# Sample Approved Sheet

## Hetuo (R1310A) Acknowledgment

Customer Name Dongguan Ruihe Electronic Technology Co., Ltd

Client Type \_\_\_\_\_ R1310A

Brand \_\_\_\_\_ HT-R1310A-R-V1

### Hetuo Judgment Audit Team

Formulate	Check	Ratify	Acknowledge the book completion time
Liyaona	Huxuewen	Daitingting	2024.01.08

### (Client) Judgment Audit Team

Acknowledgement Number \_\_\_\_\_

Proving time

acknowledge	check	ratify	Acknowledge the book completion time

Project Review  Three acknowledgements  Specifications/drawings

examining report  Specimen PCS  Safety standard  HSF

Appraisal report  Accept

Conditional acceptance

Refuse

## 1. Antenna picture

The report mainly provides the test status of the electrical properties parameters of R1310A. The R1310A antenna is a 2.4-2.5GHz Band. The antenna Picture and assembly are shown below.  
Antenna picture & assembly picture

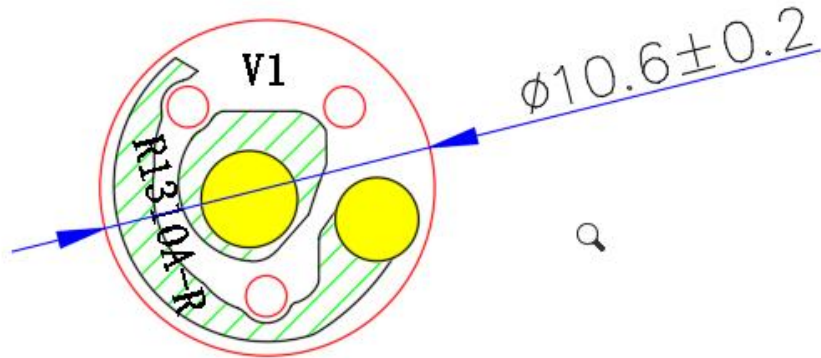

## 2. Antenna Test Equipment Introduction

Test of antenna input characteristics using Agilent E5071C and Agilent 5062A vector network analyzer; The radiation pattern of the antenna are tested using the Satimo starlab 3D near field Anechoic Chamber, and the instrument is used to agilent8960 E5515 and Agilent E4438C. The test coordinates of the darkroom are as follows:



图 4 3D 微波暗室测试坐标系 (back view)

## 3. Electrical Specification

### 3-2 Passive S11 parameter

Measuring Method is a  $50\ \Omega$  coaxial cable is connected to the antenna. Then this cable is connected to a network analyzer to measure the S11 parameter, Keeping this fixture away from metal at least 20cm.

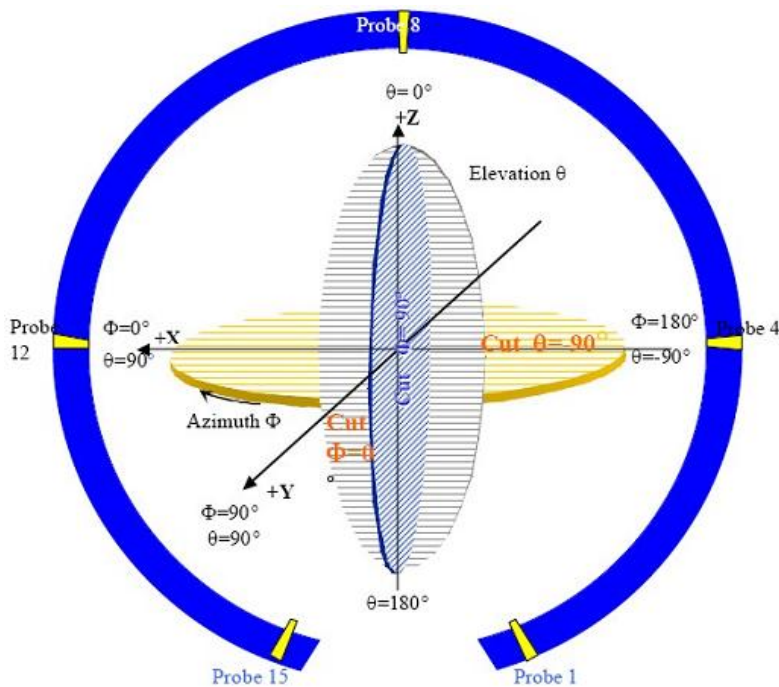
VSWR—R

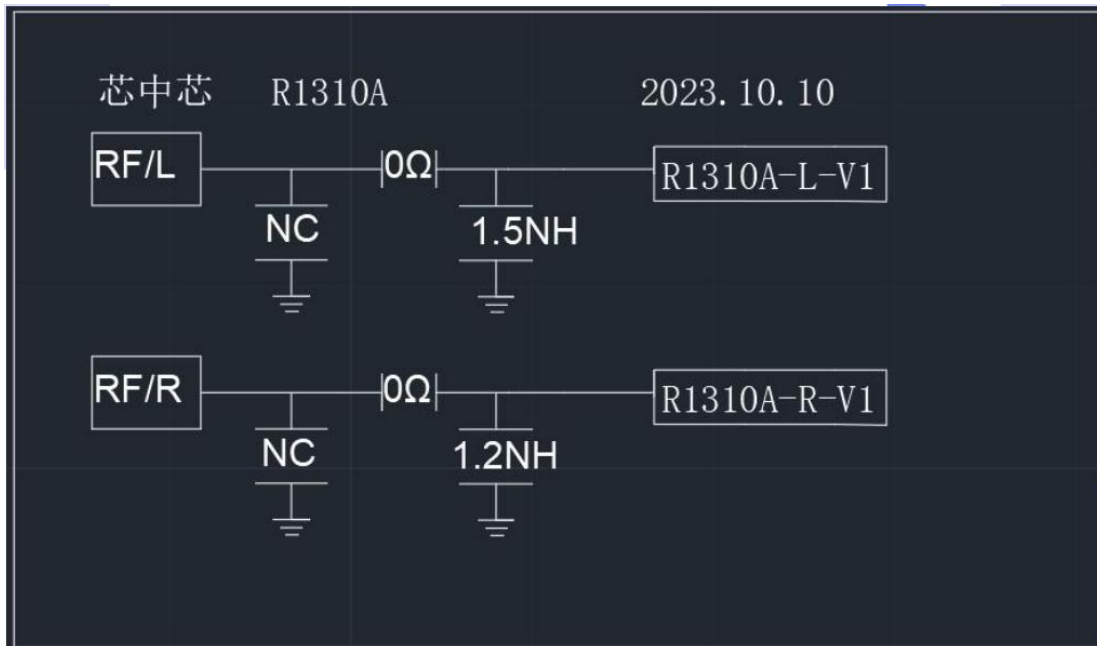

# Sample status & coordinates

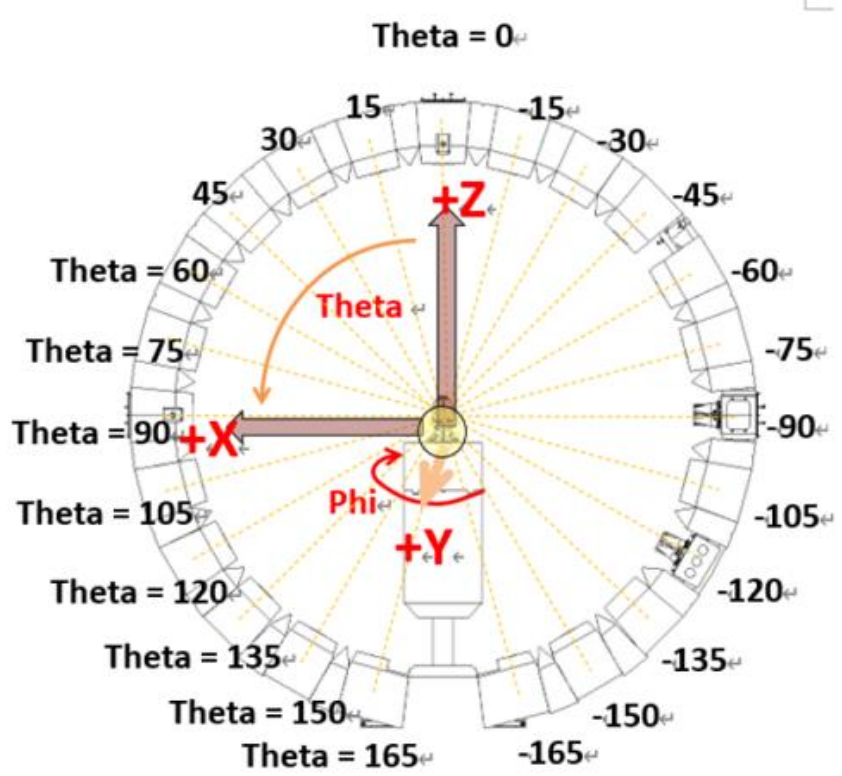

S11—R(BT ANT)

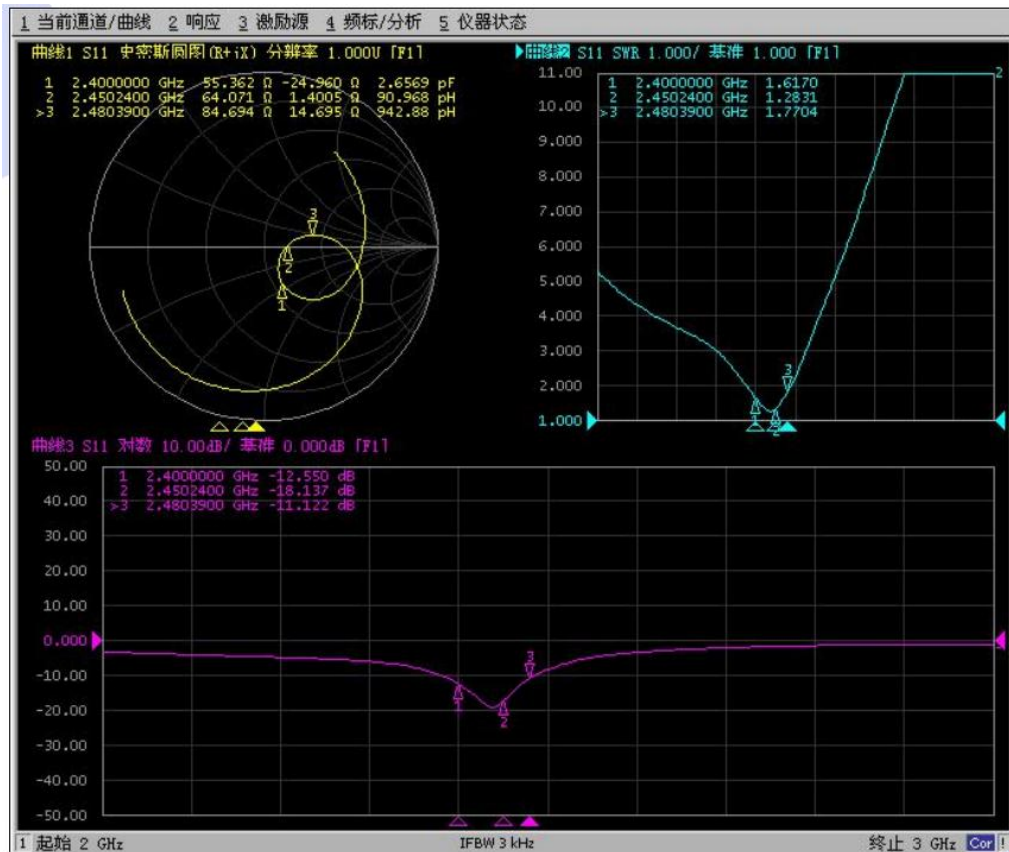

3-3 Antenna Matching Network

Gain & Efficiency—BT-ANT-R



**深圳市合拓科技有限公司**

Frequency ID	1	2	3	4	5	6	7	8	9	10	11
Frequency (MHz)	2400.0	2410.0	2420.0	2430.0	2440.0	2450.0	2460.0	2470.0	2480.0	2490.0	2500.0
Efficiency (dBi)	-7.98	-7.69	-7.52	-7.26	-7.33	-7.39	-7.46	-7.61	-7.82	-7.92	-8.04
Gain (dBi)	-4.47	-4.00	-3.30	-2.95	-3.35	-3.07	-3.24	-3.45	-4.19	-4.10	-4.25
Efficiency (%)	15.93	17.02	17.72	18.80	18.50	18.23	17.97	17.34	16.51	16.14	15.72
Directivity (dB)	3.51	3.69	4.22	4.31	3.98	4.32	4.22	4.16	3.63	3.82	3.78
Peak Gain Position (Theta)	135.00	135.00	135.00	135.00	135.00	135.00	135.00	135.00	135.00	120.00	120.00
Peak Gain Position (Phi)	210.00	210.00	210.00	225.00	225.00	240.00	225.00	225.00	225.00	225.00	240.00
Efficiency ThetaPol (%)	6.79	7.36	7.63	8.28	8.37	8.27	8.38	8.18	8.00	7.84	7.58
Efficiency PhiPol (%)	9.14	9.66	10.08	10.52	10.13	9.96	9.59	9.16	8.51	8.30	8.14
Upper Hem. Efficiency (%)	7.54	7.90	8.15	8.71	8.50	8.30	8.26	7.86	7.68	7.51	7.29
Lower Hem. Efficiency (%)	8.38	9.12	9.57	10.09	10.00	9.93	9.70	9.48	8.82	8.63	8.42

Gain (dBi)	-4.47	-4.00	-3.30	-2.95	-3.35	-3.07	-3.24	-3.45	-4.19	-4.10	-4.25
Efficiency (%)	15.93	17.02	17.72	18.80	18.50	18.23	17.97	17.34	16.51	16.14	15.72



2D/3D—BT-R

2D&3D—BT-ANT

2400.0MHz H+V, Eff: 15.9%

Back View

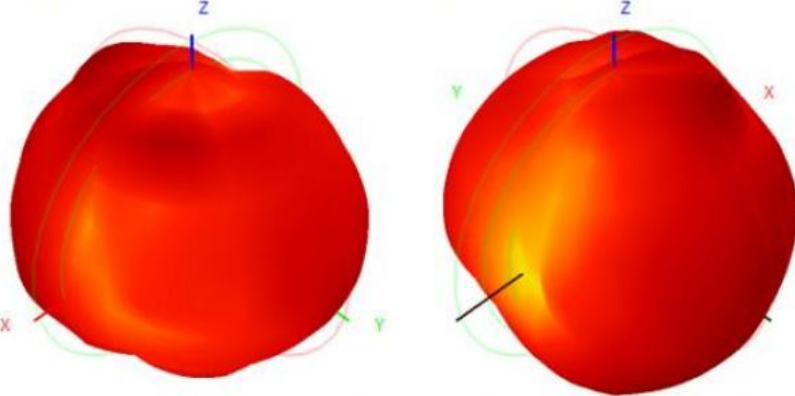

400.0MHz Total(E1-XZ), Max=-6.02dBi

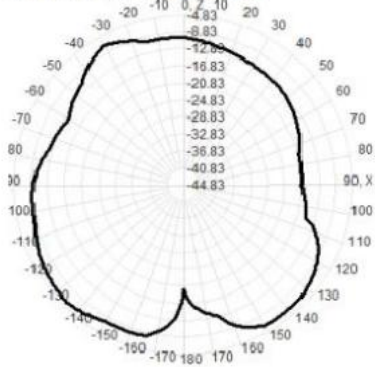

2400.0MHz Total(E2-YZ), Max=-4.83dBi

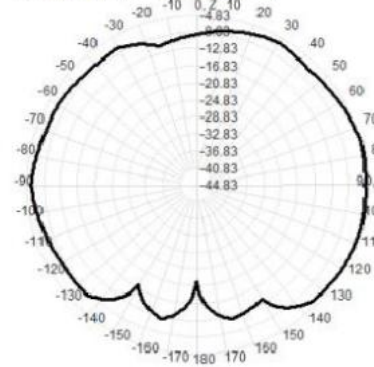

Total(H-XY), Max=-5.19dBi, CirD=12.02

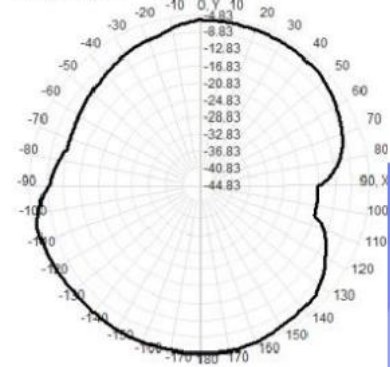

2D&3D—BT-ANT

2450.0MHz H+V, Eff: 18.2%

Back View

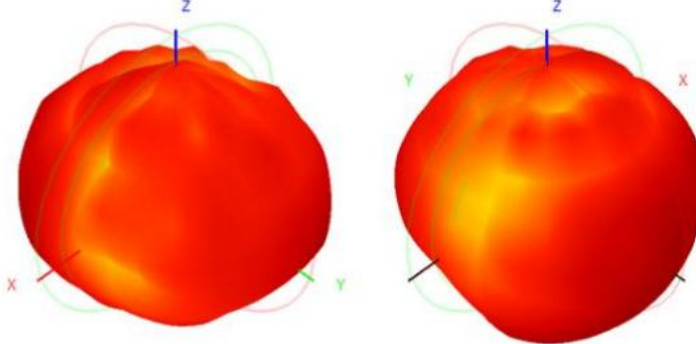

150.0MHz Total(E1-XZ), Max=-4.82dBi

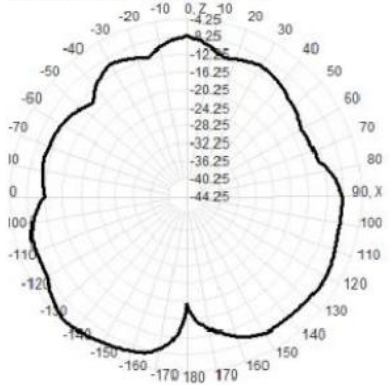

2450.0MHz Total(E2-YZ), Max=-4.25dBi

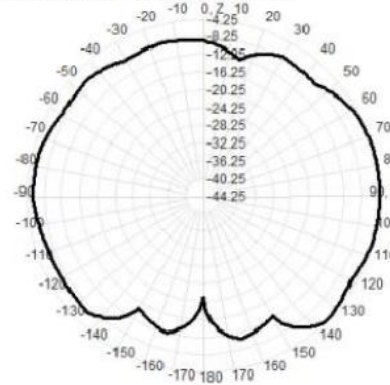

Total(H-XY), Max=-4.25dBi, CirD=9.72

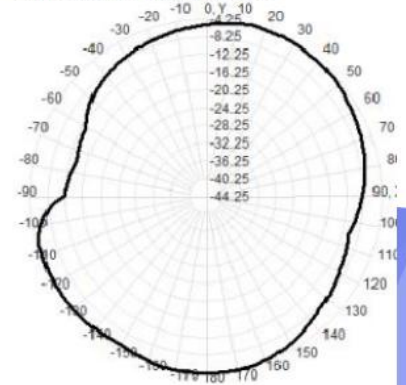

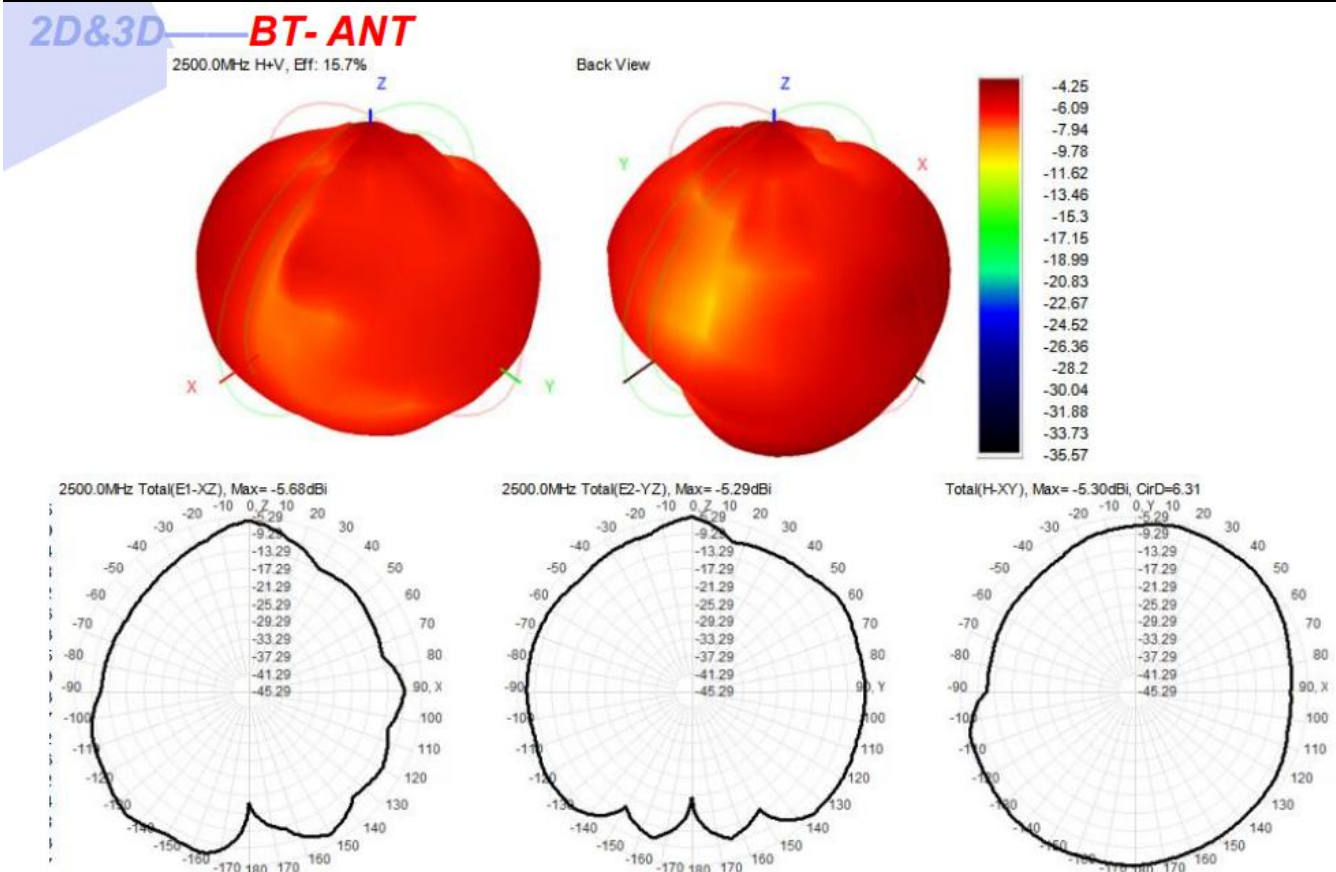

OTA DATA(R)--FS

**Bluetooth Band Antenna Performance Table**

(dBi) 1.42  
(dBm) -88.01

el	Freq. (MHz)	TRP (dBm)	TIS (dBm)	Gain (dBi)	Directivity (dBi)	Efficiency (%)	Efficiency (dB)	Max (dBm)	Theta of Max	Phi of Max	Min (dBm)	Theta of Min	Phi of Min	AVG (dBm)	Max/Min (dB)
		1.08						5.01	0	0	-7.32	0	0	1.07	12.33
		1.14						5.52	0	1	-4.83	0	1	1.05	10.35
		1.96						5.52	0	2	-4.57	0	2	1.81	10.09
			-89.57					-81.17	0	0	-93.50	0	0	-87.88	12.33
			-86.69					-80.72	0	1	-91.07	0	1	-85.04	10.35
			-87.18					-80.55	0	2	-90.74	0	2	-85.60	10.09

OTA DATA(R)--BH

**Bluetooth Band Antenna Performance Table**

(dBi) -0.24  
(dBm) -86.51

el	Freq. (MHz)	TRP (dBm)	TIS (dBm)	Gain (dBi)	Directivity (dBi)	Efficiency (%)	Efficiency (dB)	Max (dBm)	Theta of Max	Phi of Max	Min (dBm)	Theta of Min	Phi of Min	AVG (dBm)	Max/Min (dB)
		-0.16						3.66	0	0	-8.98	0	0	-0.55	12.84
		-0.22						3.66	0	1	-7.34	0	1	-0.45	11.01
		-0.34						4.19	0	2	-7.32	0	2	0.05	11.52
			-87.56					-79.74	0	0	-92.58	0	0	-85.46	12.84
			-86.17					-79.75	0	1	-90.75	0	1	-84.39	11.01
			-85.55					-78.57	0	2	-90.08	0	2	-83.60	11.52

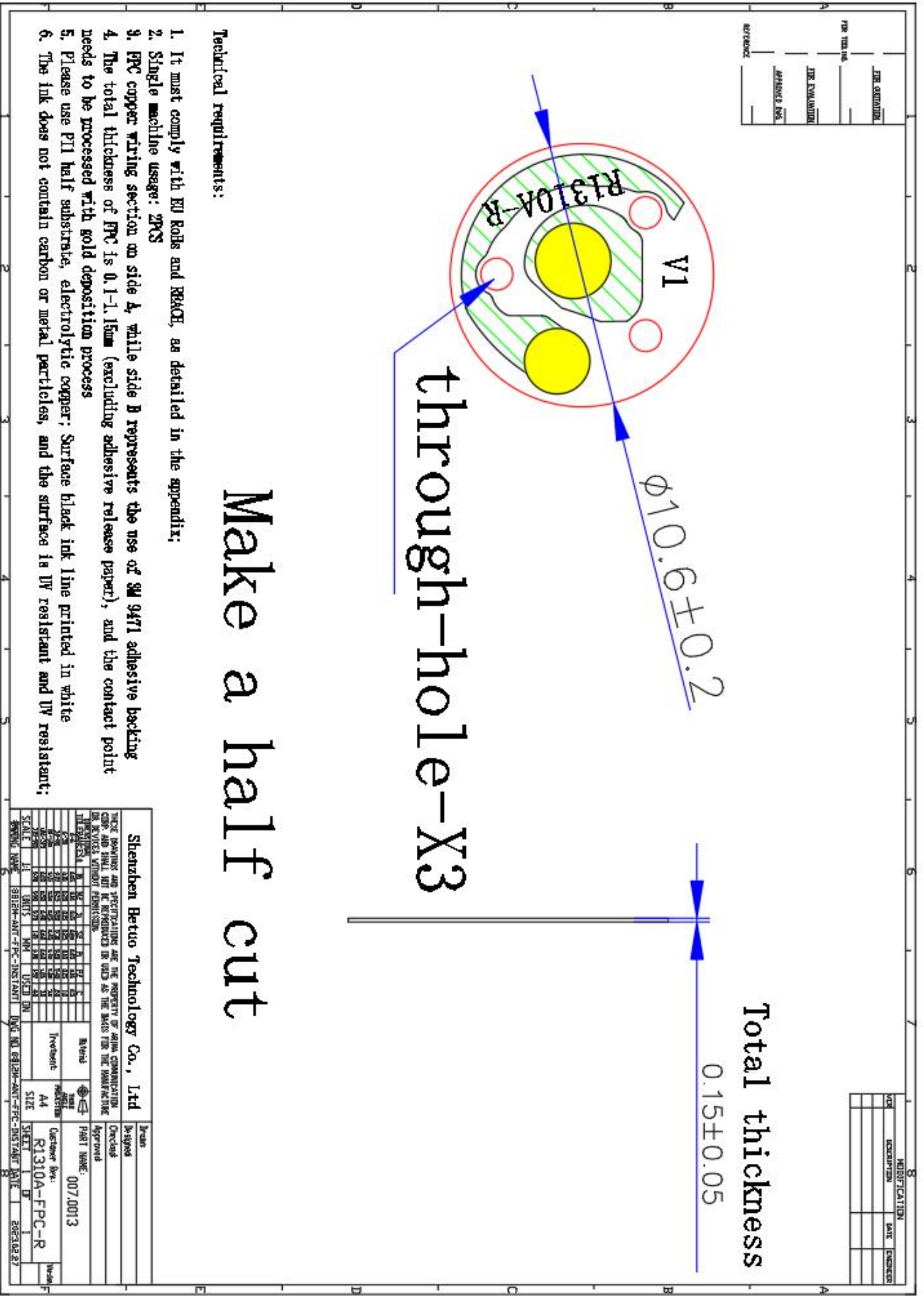

Make a half cut