



RF TEST REPORT

Product Name: A4 thermal printer

Model Name: D210, S8, X8

FCC ID: 2A2AI-D210

Issued For : Shenzhen Yinxiaoqian technology Co., Ltd.

202E, building A4, Hom Industrial Zone, 41 Wuhe Avenue
(South) Nankeng community, Bantian street, Longgang
District, Shenzhen. China

Issued By : Shenzhen LGT Test Service Co., Ltd.

Room 205, Building 13, Zone B, Zhenxiong Industrial Park,
No.177, Renmin West Road, Jinsha, Kengzi Street, Pingshan
District, Shenzhen, Guangdong, China

Report Number: LGT24D039RF02

Sample Received Date: Apr. 09, 2024

Date of Test: Apr. 09, 2024 – Apr. 25, 2024

Date of Issue: Apr. 25, 2024

The test report is effective only with both signature and specialized stamp. This report shall not be reproduced except in full without the written approval of the Laboratory. The results in this report only apply to the tested sample.



TEST REPORT CERTIFICATION

Applicant: Shenzhen Yinxiaoqian technology Co., Ltd.
Address: 202E, building A4, Hom Industrial Zone, 41 Wuhe Avenue (South)
Nankeng community, Bantian street, Longgang District, Shenzhen.China

Manufacturer: Shenzhen Yinxiaoqian technology Co., Ltd.
Address: 202E, building A4, Hom Industrial Zone, 41 Wuhe Avenue (South)
Nankeng community, Bantian street, Longgang District, Shenzhen.China

Product Name: A4 thermal printer

Trademark: MARKLIFE

Model Name: D210, S8, X8

Sample Status: Normal

APPLICABLE STANDARDS	
STANDARD	TEST RESULTS
FCC Part 15.247, Subpart C ANSI C63.10-2013	PASS

Prepared by:

Zane Shan

Zane Shan
Engineer

Approved by:

Vita Li

Vita Li
Technical Director





Table of Contents	Page
1. SUMMARY OF TEST RESULTS	6
1.1 TEST FACTORY	7
1.2 MEASUREMENT UNCERTAINTY	7
2. GENERAL INFORMATION	8
2.1 GENERAL DESCRIPTION OF THE EUT	8
2.2 DESCRIPTION OF THE TEST MODES	9
2.3 TEST SOFTWARE AND POWER LEVEL	9
2.4 DESCRIPTION OF NECESSARY ACCESSORIES AND SUPPORT UNITS	10
2.5 EQUIPMENTS LIST	11
3. EMC EMISSION TEST	12
3.1 CONDUCTED EMISSION MEASUREMENT	12
3.2 TEST PROCEDURE	13
3.3 TEST SETUP	13
3.4 EUT OPERATING CONDITIONS	13
3.5 TEST RESULTS	14
4. RADIATED EMISSION MEASUREMENT	16
4.1 RADIATED EMISSION LIMITS	16
4.2 TEST PROCEDURE	18
4.3 TEST SETUP	18
4.4 EUT OPERATING CONDITIONS	19
4.5 FIELD STRENGTH CALCULATION	19
4.6 TEST RESULTS (BAND EDGE REQUIREMENTS)	25
5. CONDUCTED SPURIOUS & BAND EDGE EMISSION	27
5.1 LIMIT	27
5.2 TEST PROCEDURE	27
5.3 TEST SETUP	27
5.4 EUT OPERATION CONDITIONS	27
5.5 TEST RESULTS	27
6. POWER SPECTRAL DENSITY TEST	28
6.1 LIMIT	28
6.2 TEST PROCEDURE	28
6.3 TEST SETUP	28
6.4 EUT OPERATION CONDITIONS	28



Table of Contents	Page
6.5 TEST RESULTS	28
7. BANDWIDTH TEST	29
7.1 LIMIT	29
7.2 TEST PROCEDURE	29
7.3 TEST SETUP	29
7.4 EUT OPERATION CONDITIONS	29
7.5 TEST RESULTS	29
8. PEAK OUTPUT POWER TEST	30
8.1 LIMIT	30
8.2 TEST PROCEDURE	30
8.3 TEST SETUP	30
8.4 EUT OPERATION CONDITIONS	30
8.5 TEST RESULTS	30
9. ANTENNA REQUIREMENT	31
9.1 STANDARD REQUIREMENT	31
9.2 EUT ANTENNA	31
APPENDIX I - TEST RESULTS	32
DUTY CYCLE	32
MAXIMUM PEAK CONDUCTED OUTPUT POWER	34
-6DB BANDWIDTH	35
OCCUPIED CHANNEL BANDWIDTH	37
MAXIMUM POWER SPECTRAL DENSITY LEVEL	39
BAND EDGE	41
CONDUCTED RF SPURIOUS EMISSION	44



Revision History

Rev.	Issue Date	Revisions
00	Apr. 25, 2024	Initial Issue



1. SUMMARY OF TEST RESULTS

Test procedures according to the technical standards:
KDB 558074 D01 Part 15.247 Meas Guidance v05r02.

FCC Part 15.247, Subpart C			
Standard Section	Test Item	Judgment	Remark
15.207	Conducted Emission	PASS	--
15.247 (a)(2)	6dB Bandwidth	PASS	--
15.247 (b)(3)	Output Power	PASS	--
15.209	Radiated Spurious Emission	PASS	--
15.247 (d)	Conducted Spurious & Band Edge Emission	PASS	--
15.247 (e)	Power Spectral Density	PASS	--
15.205	Restricted Band Edge Emission	PASS	--
Part 15.247(d)/ Part 15.209(a)	Band Edge Emission	PASS	--
15.203	Antenna Requirement	PASS	--

NOTE:

- (1) 'N/A' denotes test is not applicable in this Test Report.
- (2) All tests are according to ANSI C63.10-2013.



1.1 TEST FACTORY

Company Name:	Shenzhen LGT Test Service Co., Ltd.
Address:	Room 205, Building 13, Zone B, Zhenxiong Industrial Park, No.177, Renmin West Road, Jinsha, Kengzi Street, Pingshan District, Shenzhen, Guangdong, China
Accreditation Certificate	A2LA Certificate No.: 6727.01
	FCC Registration No.: 746540
	CAB ID: CN0136

1.2 MEASUREMENT UNCERTAINTY

The reported uncertainty of measurement $y \pm U$, where expanded uncertainty U is based on a standard uncertainty multiplied by a coverage factor of $k=2$, providing a level of confidence of approximately **95** %.

No.	Item	Uncertainty
1	RF output power, conducted	± 0.68 dB
2	Unwanted Emissions, conducted	± 2.988 dB
3	All emissions, radiated 9K-30MHz	± 2.84 dB
4	All emissions, radiated 30M-1GHz	± 4.39 dB
5	All emissions, radiated 1G-6GHz	± 5.10 dB
6	All emissions, radiated >6G	± 5.48 dB
7	Conducted Emission (9KHz-150KHz)	± 2.79 dB
8	Conducted Emission (150KHz-30MHz)	± 2.80 dB

Note: The measurement uncertainty is not included in the test result.



2. GENERAL INFORMATION

2.1 GENERAL DESCRIPTION OF THE EUT

Product Name:	A4 thermal printer		
Trademark:	MARKLIFE		
Model Name:	D210		
Series Model:	S8, X8		
Model Difference:	Only the model is different.		
Product Description:	Operation Frequency:	2402~2480 MHz	
	Modulation Type:	GFSK	
	Radio Technology:	BLE	
	Bluetooth Configuration:	BLE (1M PHY)	
	Number Of Channel:	40	
	Antenna Designation:	PCB	
	Antenna Gain (dBi)	-0.93	
Channel List:	Please refer to the Note 3.		
Rating:	Input: AC 100V-240V,50-60Hz Output: DC 5V, 2A		
Battery:	Capacity: 2600mAh Rated Voltage: 7.4V, 19.24Wh		
Hardware Version:	N/A		
Software Version:	N/A		
Connecting I/O Port(s):	Please refer to the Note 1.		

Note:

1. For a more detailed features description, please refer to the manufacturer's specifications or the User Manual.
2. The antenna information refers to the manufacturer provide report, applicable only to the tested sample identified in the report. Due to the incorrect antenna information, a series of problems such as the accuracy of the test results will be borne by the customer.
- 3.

Channel List							
Channel	Frequency (MHz)	Channel	Frequency (MHz)	Channel	Frequency (MHz)	Channel	Frequency (MHz)
00	2402	10	2422	20	2442	30	2462
01	2404	11	2424	21	2444	31	2464
02	2406	12	2426	22	2446	32	2466
03	2408	13	2428	23	2448	33	2468
04	2410	14	2430	24	2450	34	2470
05	2412	15	2432	25	2452	35	2472
06	2414	16	2434	26	2454	36	2474
07	2416	17	2436	27	2456	37	2476
08	2418	18	2438	28	2458	38	2478
09	2420	19	2440	29	2460	39	2480



2.2 DESCRIPTION OF THE TEST MODES

For conducted test items and radiated spurious emissions
Each of these EUT operation mode(s) or test configuration mode(s) mentioned below was evaluated respectively.

Worst Mode	Description	Data/Modulation
Mode 1	TX CH00(2402MHz)	1 MHz/GFSK
Mode 2	TX CH19(2440MHz)	1 MHz/GFSK
Mode 3	TX CH39(2480MHz)	1 MHz/GFSK

Note:

- (1) The measurements are performed at all Bit Rate of Transmitter, the worst data was reported.
- (2) We have be tested for all avaiable U.S. voltage and frequency (For 120V,50/60Hz and 240V, 50/60Hz) for which the device is capable of operation, and the worst case of 120V/60Hz is shown in the report.
- (3) The battery is fully-charged during the radited and RF conducted test.

For AC Conducted Emission

Test Case	
AC Conducted Emission	Mode 4: Keeping BLE TX

2.3 TEST SOFTWARE AND POWER LEVEL

During testing channel & power controlling software provided by the customer was used to control the operating channel as well as the output power level.

Test software Version	Test program: BLE	
fcc_test_tool_V2.4.1	Mode Or Modulation type	Power setting
	1M	Default



2.4 DESCRIPTION OF NECESSARY ACCESSORIES AND SUPPORT UNITS

The EUT has been tested as an independent unit together with other necessary accessories or support units. The following support units or accessories were used to form a representative test configuration during the tests.

Accessories Equipment

Description	Manufacturer	Model	S/N	Rating
USB-A to USB-C Cable	N/A	N/A	N/A	1.2m

Auxiliary Equipment

Description	Manufacturer	Model	S/N	Rating
Laptop	Lenovo	HKF-16	N/A	N/A

Note:

- (1) For detachable type I/O cable should be specified the length in cm in 『Length』 column.
- (2) “YES” is means “with core”; “NO” is means “without core”.



2.5 EQUIPMENTS LIST

Conducted Emission					
Equipment	Manufacturer	Model No.	Serial No.	Cal. Date	Cal. Until
EMI Test Receiver	R&S	ESU8	100372	2024.03.09	2025.03.08
LISN	COM-POWER	LI-115	02032	2024.03.09	2025.03.08
LISN	SCHWARZBECK	NNLK 8122	00160	2024.03.09	2025.03.08
Transient Limiter	CYBERTEK	EM5010A	E2250100049	2024.03.09	2025.03.08
Temperature & Humidity	KTJ	TA218B	N.A	2024.03.09	2025.03.08
Testing Software	EMC-I_V1.4.0.3_SKET				

Radiated Test equipment					
Equipment	Manufacturer	Model No.	Serial No.	Cal. Date	Cal. Until
EMI Test Receiver	R&S	ESU8	100372	2024.03.09	2025.03.08
Active loop Antenna	ETS	6502	00049544	2023.10.13	2025.10.12
Spectrum Analyzer	Keysight	N9010B	MY60242508	2023.08.14	2024.08.13
Bilog Antenna(30M-1G)	SCHWARZBECK	VULB 9168	2705	2022.12.12	2025.12.11
Horn Antenna(1-18G)	SCHWARZBECK	3115	10SL0060	2022.06.02	2025.06.01
Horn Antenna(18-40G)	A-INFO	LB-180400-KF	J211060273	2022.06.08	2025.06.07
Pre-amplifier(30M-1G)	EMtrace	RP01A	02019	2024.03.09	2025.03.08
Pre-amplifier(1-26.5G)	Agilent	8449B	3008A4722	2024.03.09	2025.03.08
Pre-amplifier(18-40G)	com-mw	LNPA_18-40-01	18050003	2024.03.09	2025.03.08
Wireless Communications Test Set	R&S	CMW 500	137737	2024.03.09	2025.03.08
Temperature & Humidity	JINGCHUANG	BT-3	N.A	2024.03.11	2025.03.10
Testing Software	EMC-I_V1.4.0.3_SKET				

RF Conducted Test equipment					
Equipment	Manufacturer	Model No.	Serial No.	Cal. Date	Cal. Until
Signal Analyzer	Keysight	N9010B	MY60242508	2023.08.14	2024.08.13
Signal Analyzer	Keysight	N9020A	MY50530994	2024.03.09	2025.03.08
RF Automatic Test system	MW	MW100-RFCB	MW220322LG-033	2024.03.09	2025.03.08
MXG Vector Signal Generator	Keysight	N5182B	MY59100717	2024.03.09	2025.03.08
Temperature & Humidity test chamber	AISRY	LX-1000L	171200018	2024.03.09	2025.03.08
Attenuator	eastsheep	90db	N.A	2024.03.09	2025.03.08
Temperature & Humidity	JINGCHUANG	BT-3	N.A	2024.03.11	2025.03.10
Digital multimeter	MASTECH	MS8261	MBGBC83053	2024.03.09	2025.03.08
Testing Software	MTS8310_V2.0.0.0_MW				



3. EMC EMISSION TEST

3.1 CONDUCTED EMISSION MEASUREMENT

3.1.1 POWER LINE CONDUCTED EMISSION LIMITS

The radio frequency voltage that is conducted back onto the AC power line on any frequency or frequencies, within the band 150 kHz to 30 MHz, shall not exceed the limits in the following table.

FREQUENCY (MHz)	Conducted Emission limit (dBuV)	
	Quasi-peak	Average
0.15 -0.5	66 - 56 *	56 - 46 *
0.50 -5.0	56.00	46.00
5.0 -30.0	60.00	50.00

Note:

- (1) The tighter limit applies at the band edges.
- (2) The limit of “ * ” marked band means the limitation decreases linearly with the logarithm of the frequency in the range.

The following table is the setting of the receiver

Receiver Parameters	Setting
Attenuation	10 dB
Start Frequency	0.15 MHz
Stop Frequency	30 MHz
IF Bandwidth	9 kHz



3.2 TEST PROCEDURE

- a. The EUT is 0.8 m from the horizontal ground plane and 0.4 m from the vertical ground plane with EUT being connected to the power mains through a line impedance stabilization network (LISN). All other support equipments are powered from additional LISN(s). The LISN provides 50 Ohm/ 50uH of coupling impedance for the measuring instrument.
- b. Interconnecting cables that hang closer than 40 cm to the ground plane shall be folded back and forth in the center forming a bundle 30 to 40 cm long.
- c. I/O cables that are not connected to a peripheral shall be bundled in the center. The end of the cable may be terminated, if required, using the correct terminating impedance. The overall length shall not exceed 1 m.
- d. LISN is at least 80 cm from the nearest part of EUT chassis.
- e. For the actual test configuration, please refer to the related Item –EUT Test Photos.

3.3 TEST SETUP

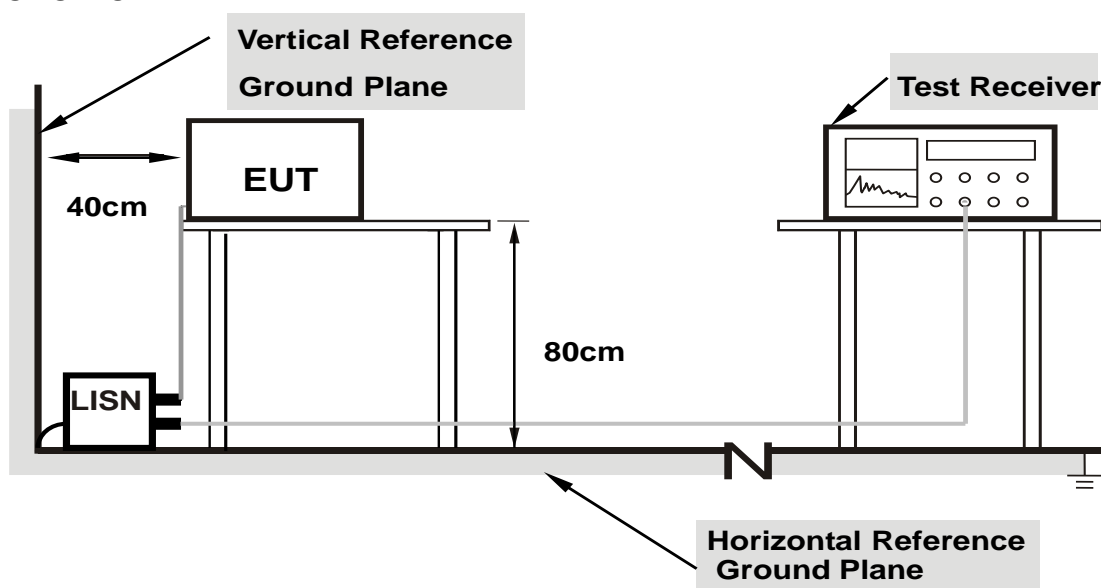

- Note: 1. Support units were connected to second LISN.**
- 2. Both of LISNs (AMN) are 80 cm from EUT and at least 80 cm from other units and other metal planes support units.**

3.4 EUT OPERATING CONDITIONS

The EUT was configured for testing in a typical fashion (as a customer would normally use it). The EUT has been programmed to continuously transmit during test. This operating condition was tested and used to collect the included data.



3.5 TEST RESULTS

Project: LGT24D039	Test Engineer: LiuH
EUT: A4 thermal printer	Temperature: 25.4°C
M/N: D210	Humidity: 54%RH
Test Voltage: AC 120V/60Hz	Test Data: 2024-04-16
Test Mode: TX BLE 2402	
Note:	

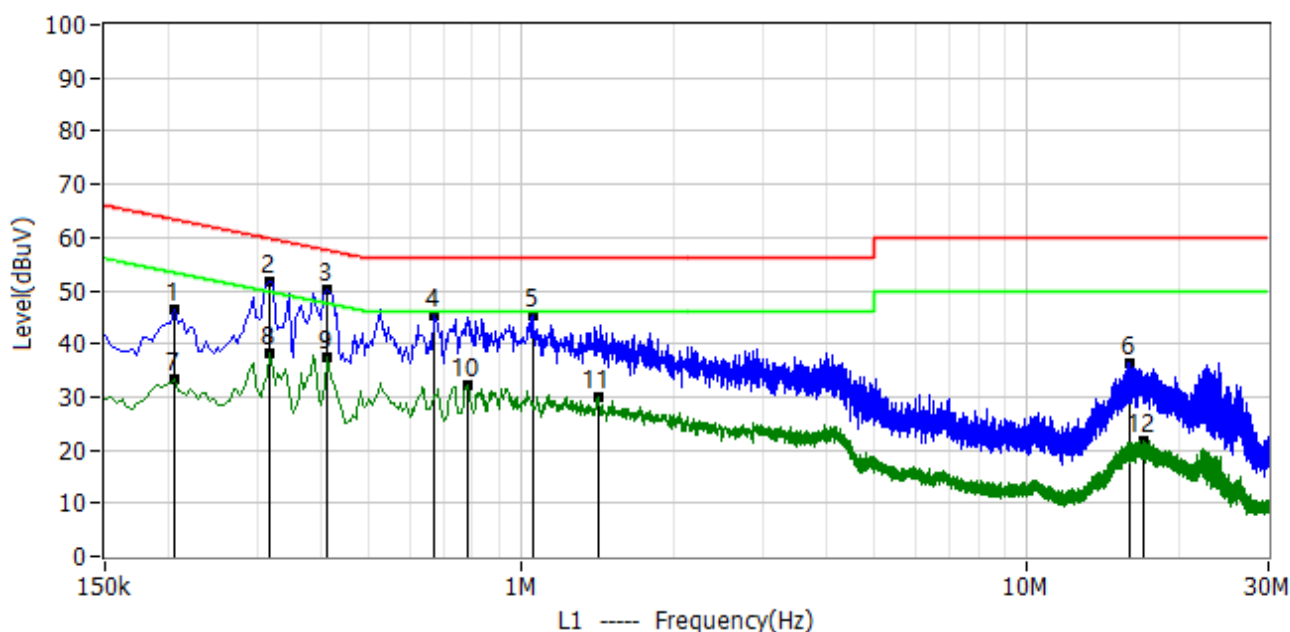

No.	Frequency MHz	Reading dBuV	Factor dB	Level dBuV	Limit dBuV	Margin dB	Detector	Polar
1*	0.206	36.08	10.34	46.42	63.37	-16.95	QP	L1
2*	0.318	41.24	10.34	51.58	59.76	-8.17	QP	L1
3*	0.414	39.88	10.35	50.23	57.57	-7.34	QP	L1
4*	0.670	35.15	10.35	45.50	56.00	-10.50	QP	L1
5*	1.058	35.11	10.37	45.48	56.00	-10.52	QP	L1
6*	15.974	25.71	10.80	36.51	60.00	-23.49	QP	L1
7*	0.206	23.14	10.34	33.48	53.37	-19.89	AV	L1
8*	0.318	27.93	10.34	38.27	49.76	-11.49	AV	L1
9*	0.414	27.00	10.35	37.35	47.57	-10.22	AV	L1
10*	0.782	21.85	10.36	32.21	46.00	-13.79	AV	L1
11*	1.414	19.49	10.44	29.93	46.00	-16.07	AV	L1
12*	16.990	10.98	10.80	21.78	50.00	-28.22	AV	L1



Project: LGT24D039	Test Engineer: LiuH
EUT: A4 thermal printer	Temperature: 25.4°C
M/N: D210	Humidity: 54%RH
Test Voltage: AC 120V/60Hz	Test Data: 2024-04-16
Test Mode: TX BLE 2402	
Note:	

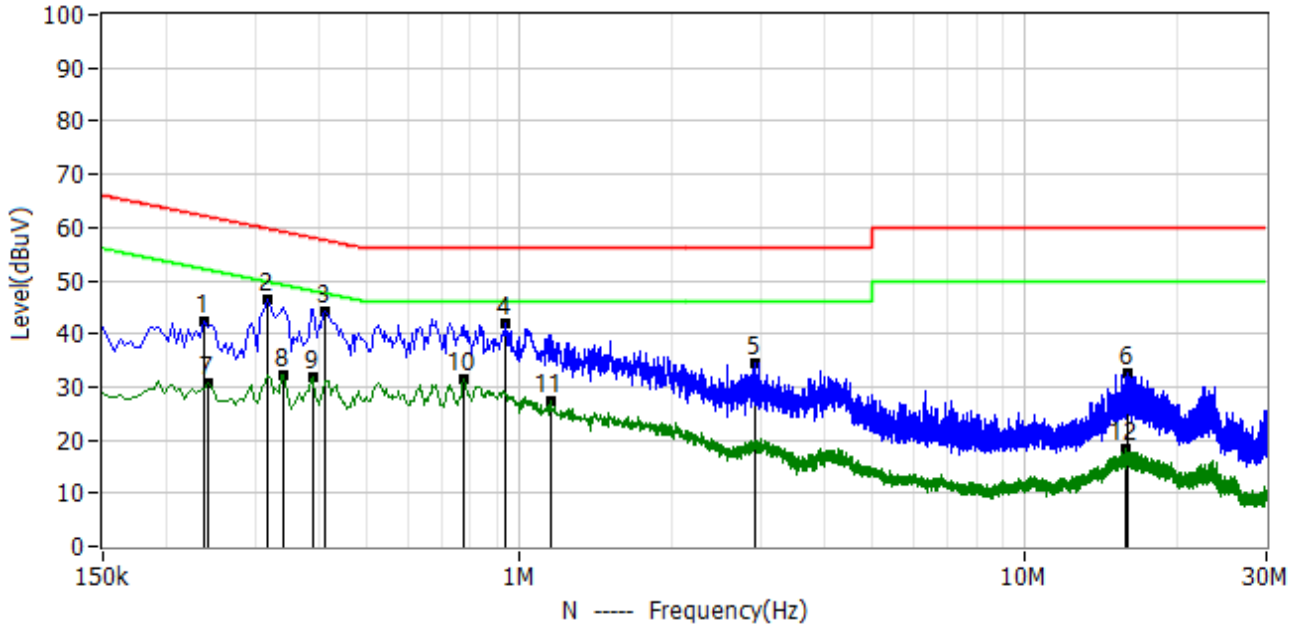

No.	Frequency MHz	Reading dBuV	Factor dB	Level dBuV	Limit dBuV	Margin dB	Detector	Polar
1*	0.238	32.00	10.44	42.44	62.17	-19.72	QP	N
2*	0.318	35.96	10.44	46.40	59.76	-13.36	QP	N
3*	0.414	33.79	10.45	44.24	57.57	-13.33	QP	N
4*	0.938	31.32	10.46	41.78	56.00	-14.22	QP	N
5*	2.914	23.92	10.66	34.58	56.00	-21.42	QP	N
6*	15.934	21.92	10.80	32.72	60.00	-27.28	QP	N
7*	0.242	20.27	10.44	30.71	52.03	-21.32	AV	N
8*	0.342	21.68	10.45	32.13	49.15	-17.02	AV	N
9*	0.390	21.38	10.45	31.83	48.06	-16.23	AV	N
10*	0.774	20.95	10.45	31.40	46.00	-14.60	AV	N
11*	1.150	16.93	10.49	27.42	46.00	-18.58	AV	N
12*	15.818	7.45	10.79	18.24	50.00	-31.76	AV	N



4. RADIATED EMISSION MEASUREMENT

4.1 RADIATED EMISSION LIMITS

In case the emission fall within the Restricted band specified on Part15.205 (a)&209(a) limit in the table and according to ANSI C63.10-2013 below has to be followed.

LIMITS OF RADIATED EMISSION MEASUREMENT (0.009MHz - 1000MHz)

Frequencies (MHz)	Field Strength (micovolts/meter)	Measurement Distance (meters)
0.009~0.490	2400/F(KHz)	300
0.490~1.705	24000/F(KHz)	30
1.705~30.0	30	30
30~88	100	3
88~216	150	3
216~960	200	3
Above 960	500	3

LIMITS OF RADIATED EMISSION MEASUREMENT (1GHz-25 GHz)

FREQUENCY (MHz)	(dBuV/m) (at 3M)	
	PEAK	AVERAGE
Above 1000	74	54

Notes:

- (1) The limit for radiated test was performed according to FCC PART 15C.
- (2) The tighter limit applies at the band edges.
- (3) Emission level (dBuV/m)=20log Emission level (uV/m).

LIMITS OF RESTRICTED FREQUENCY BANDS

FREQUENCY (MHz)	FREQUENCY (MHz)	FREQUENCY (MHz)	FREQUENCY (GHz)
0.090-0.110	16.42-16.423	399.9-410	4.5-5.15
0.495-0.505	16.69475-16.69525	608-614	5.35-5.46
2.1735-2.1905	16.80425-16.80475	960-1240	7.25-7.75
4.125-4.128	25.5-25.67	1300-1427	8.025-8.5
4.17725-4.17775	37.5-38.25	1435-1626.5	9.0-9.2
4.20725-4.20775	73-74.6	1645.5-1646.5	9.3-9.5
6.215-6.218	74.8-75.2	1660-1710	10.6-12.7
6.26775-6.26825	108-121.94	1718.8-1722.2	13.25-13.4
6.31175-6.31225	123-138	2200-2300	14.47-14.5
8.291-8.294	149.9-150.05	2310-2390	15.35-16.2
8.362-8.366	156.52475-156.52525	2483.5-2500	17.7-21.4
8.37625-8.38675	156.7-156.9	2690-2900	22.01-23.12
8.41425-8.41475	162.0125-167.17	3260-3267	23.6-24.0
12.29-12.293	167.72-173.2	3332-3339	31.2-31.8
12.51975-12.52025	240-285	3345.8-3358	36.43-36.5
12.57675-12.57725	322-335.4	3600-4400	Above 38.6
13.36-13.41			



For Radiated Emission

Spectrum Parameter	Setting
Attenuation	Auto
Detector	Peak/QP/AV
Start Frequency	9 KHz/150KHz (Peak/QP/AV)
Stop Frequency	150KHz/30MHz (Peak/QP/AV)
RB / VB (emission in restricted band)	200Hz (From 9kHz to 0.15MHz)/ 9KHz (From 0.15MHz to 30MHz); 200Hz (From 9kHz to 0.15MHz)/ 9KHz (From 0.15MHz to 30MHz)

Spectrum Parameter	Setting
Attenuation	Auto
Detector	Peak/QP
Start Frequency	30 MHz (Peak/QP)
Stop Frequency	1000 MHz (Peak/QP)
RB / VB (emission in restricted band)	120 KHz / 300 KHz

Spectrum Parameter	Setting
Attenuation	Auto
Detector	Peak
Start Frequency	1000 MHz (Peak/AV)
Stop Frequency	10th carrier harmonic (Peak/AV)
RB / VB (emission in restricted band)	1 MHz / 3 MHz(Peak) 1 MHz/1/T MHz(AVG)

For Restricted band

Spectrum Parameter	Setting
Detector	Peak
Start/Stop Frequency	Lower Band Edge: 2310 to 2410 MHz Upper Band Edge: 2475 to 2500 MHz
RB / VB	1 MHz / 3 MHz(Peak) 1 MHz/1/T MHz(AVG)

Receiver Parameter	Setting
Start ~ Stop Frequency	9kHz~90kHz / RB 200Hz for PK & AV
Start ~ Stop Frequency	90kHz~110kHz / RB 200Hz for QP
Start ~ Stop Frequency	110kHz~490kHz / RB 200Hz for PK & AV
Start ~ Stop Frequency	490kHz~30MHz / RB 9kHz for QP
Start ~ Stop Frequency	30MHz~1000MHz / RB 120kHz for QP

4.2 TEST PROCEDURE

- The measuring distance at 3 m shall be used for measurements at frequency 0.009MHz up to 1GHz, and above 1GHz.
- The EUT was placed on the top of a rotating table 0.8 m (above 1GHz is 1.5 m) above the ground at a 3 m anechoic chamber test site. The table was rotated 360 degree to determine the position of the highest radiation.
- The height of the equipment shall be 0.8 m(above 1GHz is 1.5 m); the height of the test antenna shall vary between 1 m to 4 m. Horizontal and vertical polarization of the antenna are set to make the measurement.
- The initial step in collecting conducted emission data is a spectrum analyzer peak detector mode pre-scanning the measurement frequency range. Significant peaks are then marked and QuasiPeak detector mode will be re-measured.
- If the Peak Mode measured value is compliance with and lower than Quasi Peak Mode Limit, the EUT shall be deemed to meet QP Limits and no additional QP Mode measurement was performed.
- For the actual test configuration, please refer to the related Item –EUT Test Photos.

Note:

Both horizontal and vertical antenna polarities were tested and performed pretest to three orthogonal axis. The worst case emissions were reported.

4.3 TEST SETUP

(A) Radiated Emission Test-Up Frequency Below 30MHz

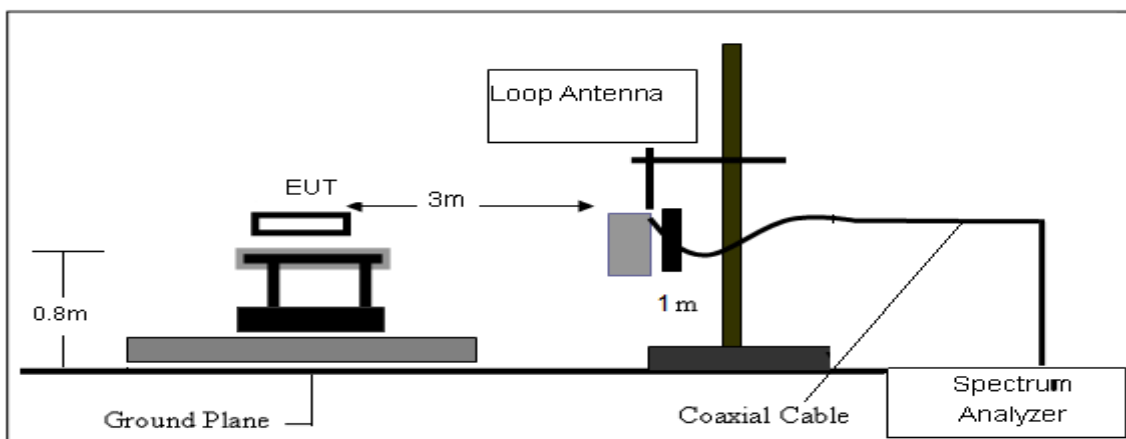

(B) Radiated Emission Test-Up Frequency 30MHz~1GHz

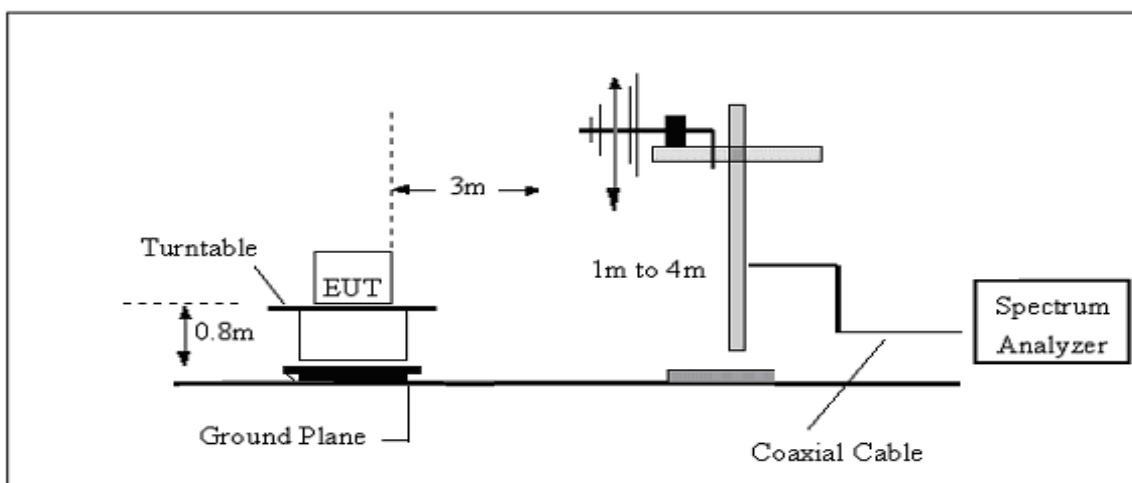

(C) Radiated Emission Test-Up Frequency Above 1GHz

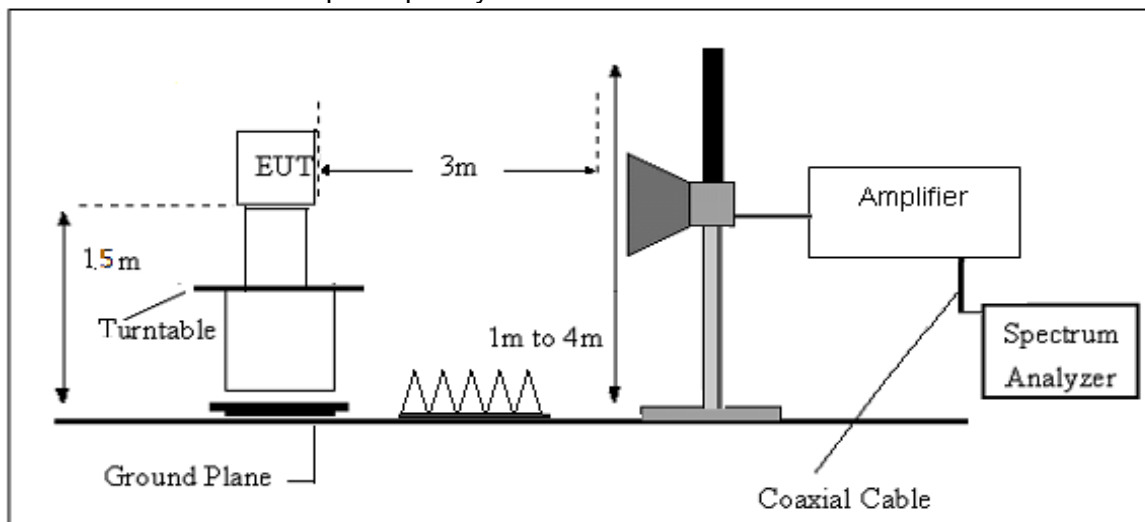

4.4 EUT OPERATING CONDITIONS

Please refer to section 3.4 of this report.

4.5 FIELD STRENGTH CALCULATION

The field strength is calculated by adding the Antenna Factor and Cable Factor and subtracting the Amplifier Gain and Duty Cycle Correction Factor (if any) from the measured reading. The basic equation with a sample calculation is as follows:

$$FS = RA + AF + CL - AG$$

Where

FS = Field Strength

CL = Cable Attenuation Factor (Cable Loss)

RA = Reading Amplitude

AG = Amplifier Gain

AF = Antenna Factor

For example

Frequency (MHz)	FS (dBμV/m)	RA (dBμV/m)	AF (dB)	CL (dB)	AG (dB)	Factor (dB)
300	40	58.1	12.2	1.6	31.9	-18.1

$$\text{Factor} = \text{AF} + \text{CL} - \text{AG}$$



4.6 TEST RESULTS

Results of Radiated Emissions (9 KHz~30MHz)

No.	Frequency	Reading dBuV	Factor dB/m	Level dBuV/m	Limit dBuV/m	Margin dB	Detector	Remark
1*	-	-	-	-	-	-	-	See Note

Note:

The emission from 9 kHz to 30MHz was pre-tested and found the result was 20dB lower than the limit, and the permissible value has no need to be reported.

Distance extrapolation factor = $40 \log (\text{specific distance} / \text{test distance})$ (dB);
Limit line = specific limits (dBuV) + distance extrapolation factor.



Results of Radiated Emissions (30MHz~1000MHz)

Project: LGT24D039	Test Engineer: Xiangdong Ma
EUT: A4 thermal printer	Temperature: 25.5°C
M/N: D210	Humidity: 42%RH
Test Voltage: Battery	Test Data: 2024-04-17
Test Mode: TX BLE 2402	
Note:	

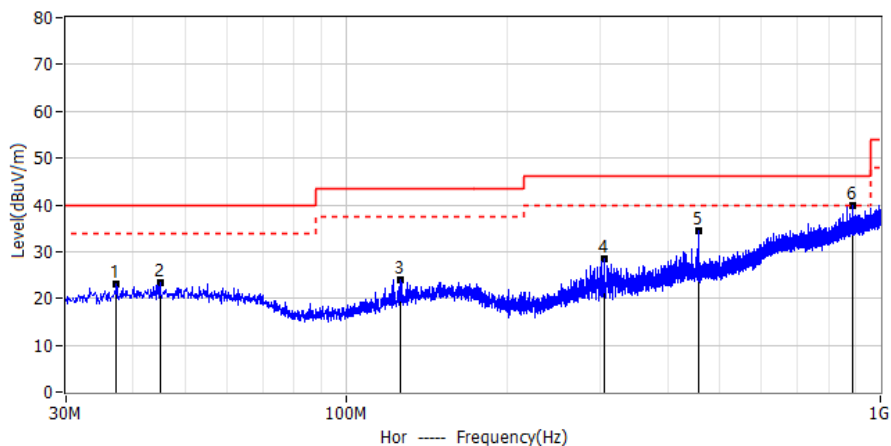

No.	Frequency MHz	Reading dBuV	Factor dB/m	Level dBuV/m	Limit dBuV/m	Margin dB	Detector	Polar
1*	37.275	4.17	18.92	23.09	40.00	-16.91	PK	Hor
2*	44.914	4.15	19.22	23.37	40.00	-16.63	PK	Hor
3*	126.273	5.92	18.18	24.10	43.50	-19.40	PK	Hor
4*	304.146	8.28	20.04	28.32	46.00	-17.68	PK	Hor
5*	456.073	10.53	23.96	34.49	46.00	-11.51	PK	Hor
6*	888.086	6.67	33.07	39.74	46.00	-6.26	PK	Hor

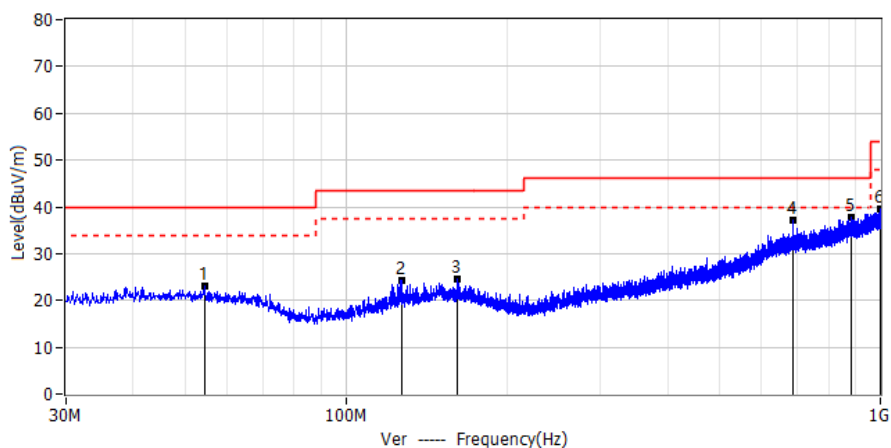

No.	Frequency MHz	Reading dBuV	Factor dB/m	Level dBuV/m	Limit dBuV/m	Margin dB	Detector	Polar
1*	54.371	4.12	19.05	23.17	40.00	-16.83	PK	Ver
2*	127.121	6.13	18.25	24.38	43.50	-19.12	PK	Ver
3*	162.041	4.70	19.83	24.53	43.50	-18.97	PK	Ver
4*	687.539	7.46	29.69	37.15	46.00	-8.85	PK	Ver
5*	879.720	4.76	32.96	37.72	46.00	-8.28	PK	Ver
6*	997.818	4.94	34.56	39.50	54.00	-14.50	PK	Ver



Results of Radiated Emissions (Above 1000MHz)

Note: The peak value is less than the AV limit, so no AV data is displayed.

Project: LGT24D039	Test Engineer: Xiangdong Ma
EUT: A4 thermal printer	Temperature: 25.5°C
M/N: D210	Humidity: 42%RH
Test Voltage: Battery	Test Data: 2024-04-17
Test Mode: BLE 2402	
Note: Worst Case	

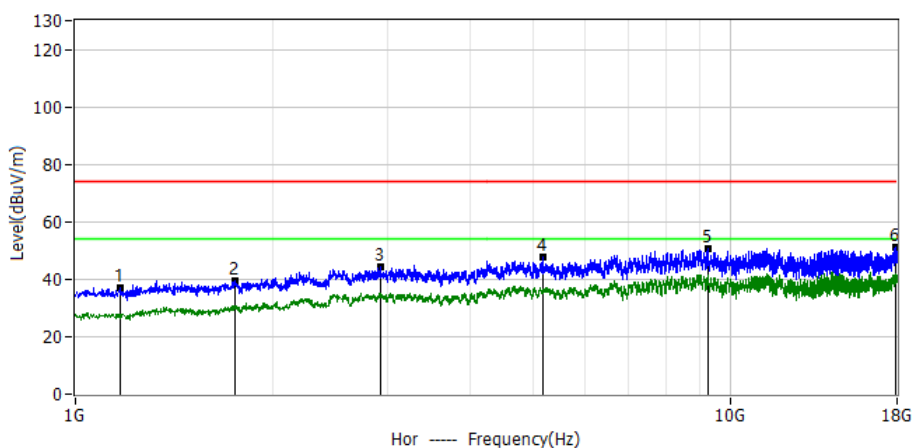

No.	Frequency MHz	Reading dBuV	Factor dB/m	Level dBuV/m	Limit dBuV/m	Margin dB	Detector	Polar
1*	1170.0000	60.44	-23.27	37.17	74.00	-36.83	PK	Hor
2*	1750.1000	58.24	-18.89	39.35	74.00	-34.65	PK	Hor
3*	2929.5000	53.20	-9.13	44.07	74.00	-29.93	PK	Hor
4*	5179.9000	55.17	-7.61	47.56	74.00	-26.44	PK	Hor
5*	9245.0000	54.30	-3.79	50.51	74.00	-23.49	PK	Hor
6*	17940.5000	49.11	1.99	51.10	74.00	-22.90	PK	Hor

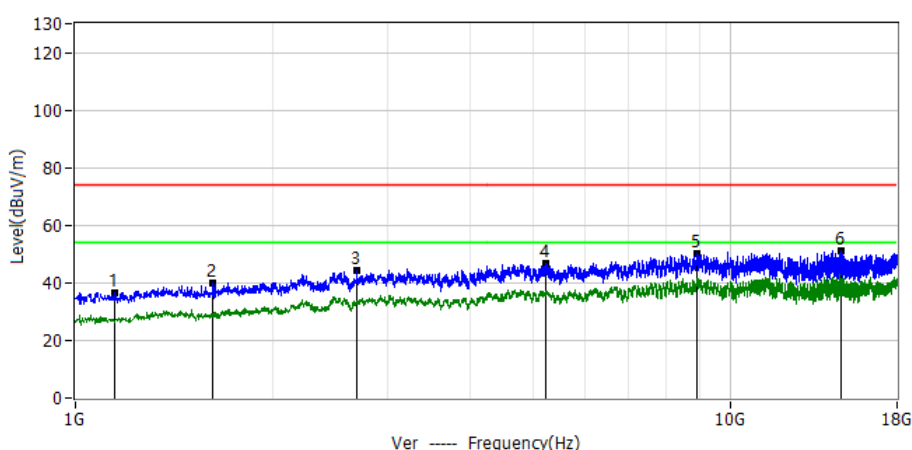

No.	Frequency MHz	Reading dBuV	Factor dB/m	Level dBuV/m	Limit dBuV/m	Margin dB	Detector	Polar
1*	1148.7000	60.21	-23.46	36.75	74.00	-37.25	PK	Ver
2*	1622.6000	59.95	-20.09	39.86	74.00	-34.14	PK	Ver
3*	2687.2000	54.73	-10.36	44.37	74.00	-29.63	PK	Ver
4*	5235.1000	54.38	-7.80	46.58	74.00	-27.42	PK	Ver
5*	8905.0000	54.09	-3.84	50.25	74.00	-23.75	PK	Ver
6*	14816.7000	50.67	0.54	51.21	74.00	-22.79	PK	Ver



Project: LGT24D039	Test Engineer: Xiangdong Ma
EUT: A4 thermal printer	Temperature: 25.5°C
M/N: D210	Humidity: 42%RH
Test Voltage: Battery	Test Data: 2024-04-17
Test Mode: BLE 2440	
Note: Worst Case	

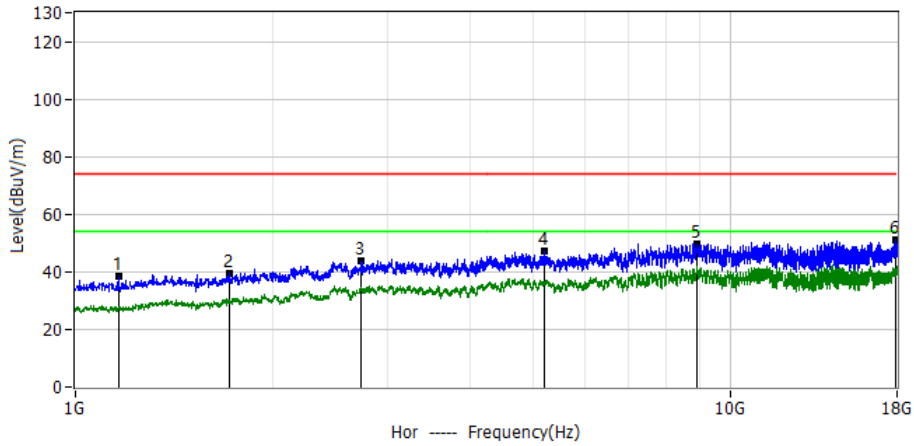

No.	Frequency MHz	Reading dBuV	Factor dB/m	Level dBuV/m	Limit dBuV/m	Margin dB	Detector	Polar
1*	1163.6000	61.92	-23.33	38.59	74.00	-35.41	PK	Hor
2*	1718.2000	58.39	-19.19	39.20	74.00	-34.80	PK	Hor
3*	2734.0000	54.16	-10.12	44.04	74.00	-29.96	PK	Hor
4*	5201.1000	54.83	-7.68	47.15	74.00	-26.85	PK	Hor
5*	8898.6000	53.71	-3.86	49.85	74.00	-24.15	PK	Hor
6*	17940.5000	48.93	1.99	50.92	74.00	-23.08	PK	Hor

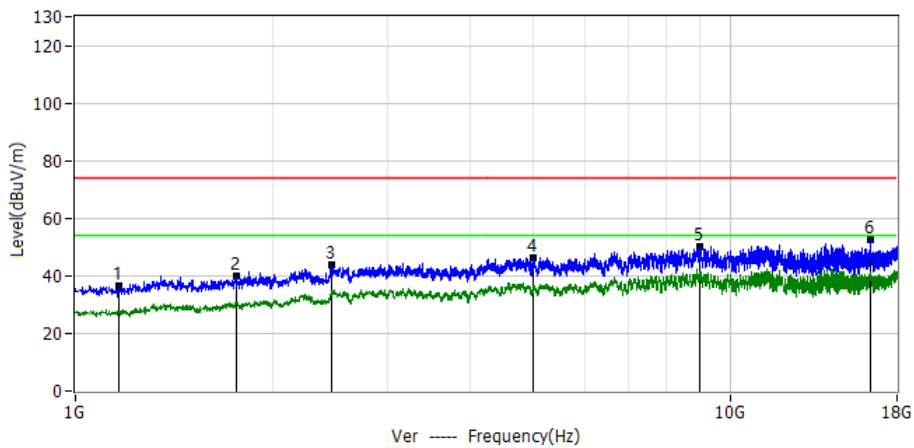

No.	Frequency MHz	Reading dBuV	Factor dB/m	Level dBuV/m	Limit dBuV/m	Margin dB	Detector	Polar
1*	1165.7000	59.90	-23.31	36.59	74.00	-37.41	PK	Ver
2*	1762.9000	58.56	-18.77	39.79	74.00	-34.21	PK	Ver
3*	2466.2000	55.38	-11.65	43.73	74.00	-30.27	PK	Ver
4*	5012.0000	53.29	-7.04	46.25	74.00	-27.75	PK	Ver
5*	8992.1000	53.92	-3.68	50.24	74.00	-23.76	PK	Ver
6*	16382.9000	51.70	0.76	52.46	74.00	-21.54	PK	Ver



Project: LGT24D039	Test Engineer: Xiangdong Ma
EUT: A4 thermal printer	Temperature: 25.5°C
M/N: D210	Humidity: 42%RH
Test Voltage: Battery	Test Data: 2024-04-17
Test Mode: BLE 2480	
Note: Worst Case	

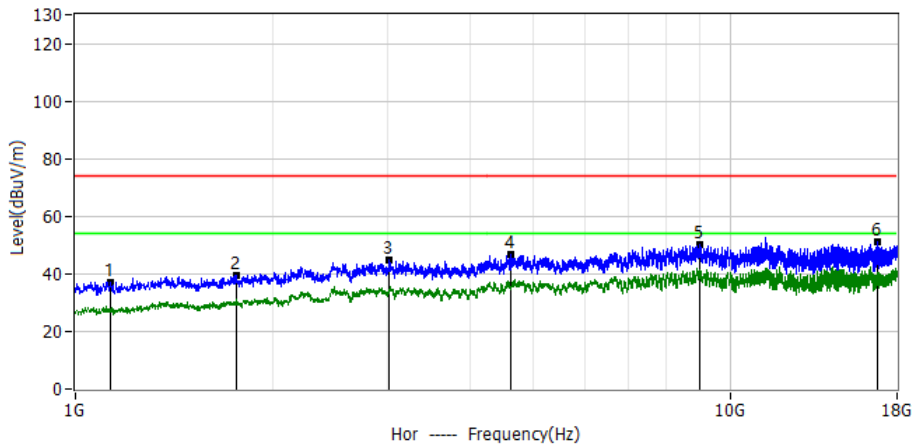

No.	Frequency MHz	Reading dBuV	Factor dB/m	Level dBuV/m	Limit dBuV/m	Margin dB	Detector	Polar
1*	1131.7000	60.84	-23.60	37.24	74.00	-36.76	PK	Hor
2*	1758.6000	58.37	-18.81	39.56	74.00	-34.44	PK	Hor
3*	3010.2000	53.49	-8.77	44.72	74.00	-29.28	PK	Hor
4*	4631.6000	53.39	-6.63	46.76	74.00	-27.24	PK	Hor
5*	9007.0000	53.90	-3.67	50.23	74.00	-23.77	PK	Hor
6*	16837.6000	49.65	1.36	51.01	74.00	-22.99	PK	Hor

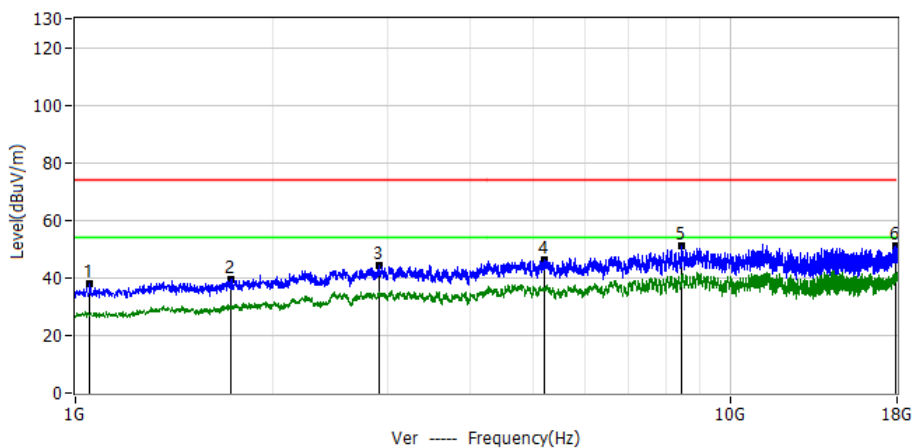

No.	Frequency MHz	Reading dBuV	Factor dB/m	Level dBuV/m	Limit dBuV/m	Margin dB	Detector	Polar
1*	1051.0000	62.07	-24.31	37.76	74.00	-36.24	PK	Ver
2*	1724.6000	58.39	-19.13	39.26	74.00	-34.74	PK	Ver
3*	2910.4000	53.41	-9.22	44.19	74.00	-29.81	PK	Ver
4*	5203.2000	53.84	-7.69	46.15	74.00	-27.85	PK	Ver
5*	8448.1000	55.61	-4.68	50.93	74.00	-23.07	PK	Ver
6*	17946.9000	48.95	2.00	50.95	74.00	-23.05	PK	Ver

Remark:

In frequency ranges 18~25GHz no any other harmonic emissions detected which are tested to compliance with the limit. No recording in the test report. No any other emissions level which are attenuated less than 20dB below the limit. No recording in the test report.



4.6 TEST RESULTS (BAND EDGE REQUIREMENTS)

Note: The peak value is less than the AV limit, so no AV data is displayed.

Project: LGT24D039	Test Engineer: Xiangdong Ma
EUT: A4 thermal printer	Temperature: 25.5°C
M/N: D210	Humidity: 42%RH
Test Voltage: Battery	Test Data: 2024-04-17
Test Mode: BLE 2402	
Note:	

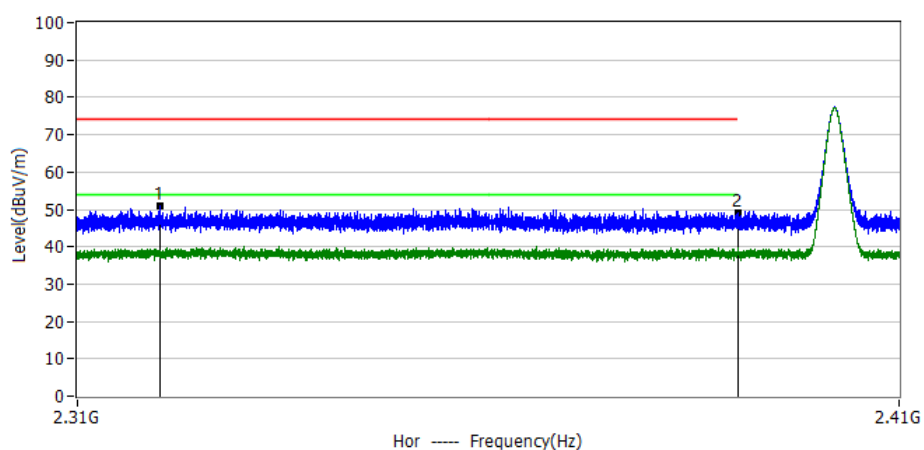

No.	Frequency MHz	Reading dBuV	Factor dB/m	Level dBuV/m	Limit dBuV/m	Margin dB	Detector	Polar
1*	2319.8000	16.71	34.12	50.83	74.00	-23.17	PK	Hor
2*	2390.0000	15.15	33.95	49.10	74.00	-24.90	PK	Hor

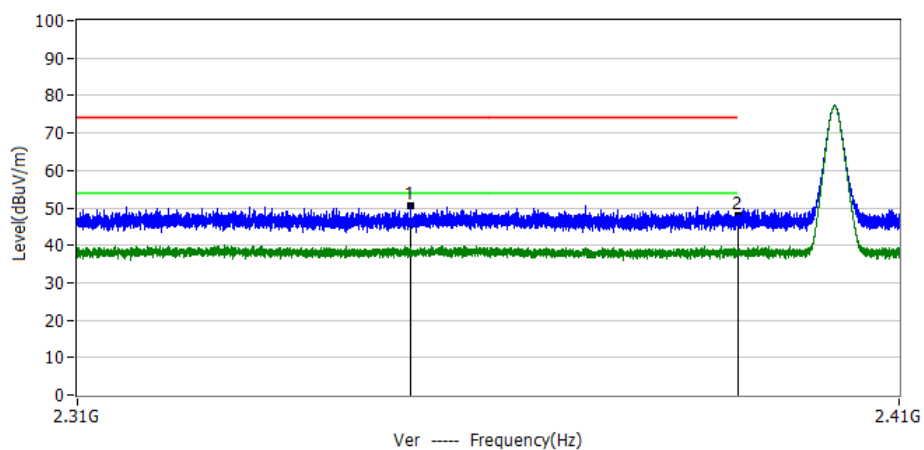

No.	Frequency MHz	Reading dBuV	Factor dB/m	Level dBuV/m	Limit dBuV/m	Margin dB	Detector	Polar
1*	2350.0000	16.59	34.05	50.64	74.00	-23.36	PK	Ver
2*	2390.0000	13.85	33.95	47.80	74.00	-26.20	PK	Ver



Project: LGT24D039	Test Engineer: Xiangdong Ma
EUT: A4 thermal printer	Temperature: 25.5°C
M/N: D210	Humidity: 42%RH
Test Voltage: Battery	Test Data: 2024-04-17
Test Mode: BLE 2480	
Note:	

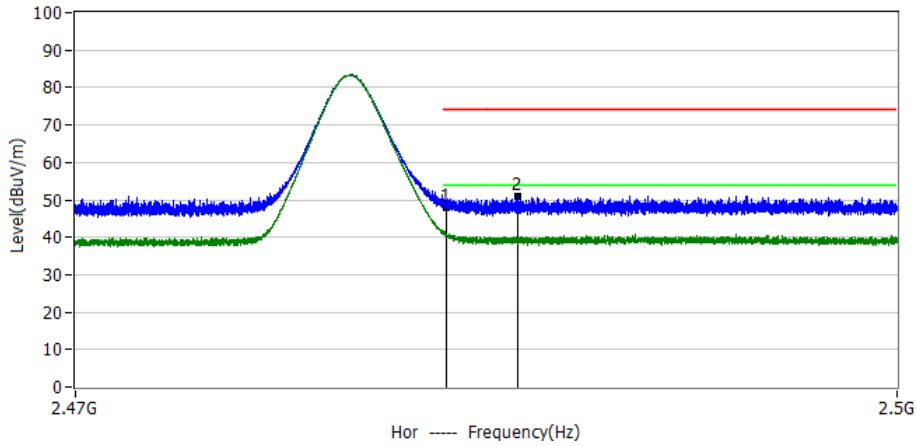

No.	Frequency MHz	Reading dBuV	Factor dB/m	Level dBuV/m	Limit dBuV/m	Margin dB	Detector	Polar
1*	2483.5000	13.97	34.13	48.10	74.00	-25.90	PK	Hor
2*	2486.1000	16.93	34.13	51.06	74.00	-22.94	PK	Hor

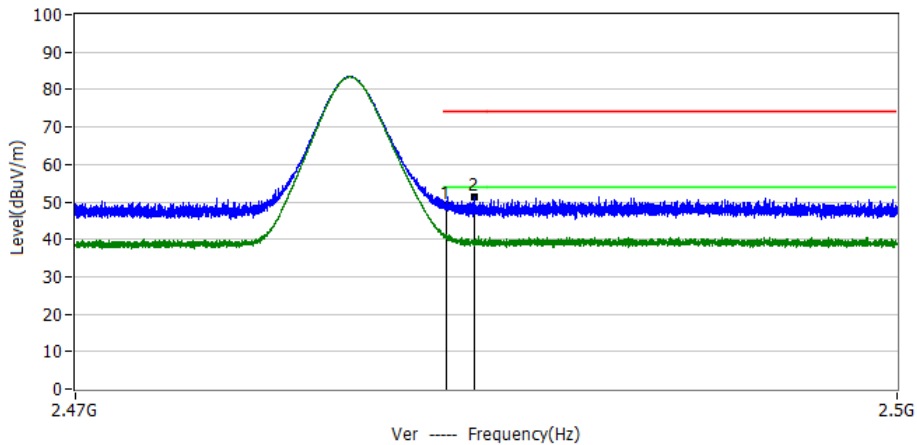

No.	Frequency MHz	Reading dBuV	Factor dB/m	Level dBuV/m	Limit dBuV/m	Margin dB	Detector	Polar
1*	2483.5000	14.87	34.13	49.00	74.00	-25.00	PK	Ver
2*	2484.5000	17.30	34.13	51.43	74.00	-22.57	PK	Ver



5. CONDUCTED SPURIOUS & BAND EDGE EMISSION

5.1 LIMIT

According to FCC section 15.247(d), in any 100kHz bandwidth outside the frequency band in which the spread spectrum or digitally modulated intentional radiator is operating, the radio frequency power that is produced by the intentional radiator shall be at least 20dB below that in the 100kHz bandwidth within the band that contains the highest level of the desired power, based on either an RF conducted or a radiated measurement.

5.2 TEST PROCEDURE

Spectrum Parameter	Setting
Detector	Peak
Start/Stop Frequency	30 MHz to 10th carrier harmonic
RB / VB (emission in restricted band)	100 KHz/300 KHz
Trace-Mode:	Max hold

For Band edge

Spectrum Parameter	Setting
Detector	Peak
Start/Stop Frequency	Lower Band Edge: 2300 – 2407 MHz Upper Band Edge: 2475 – 2500 MHz
RB / VB (emission in restricted band)	100 KHz/300 KHz
Trace-Mode:	Max hold

5.3 TEST SETUP



The EUT which is powered by the $\{ \text{POWER BY} \}$, is connected to the Spectrum Analyzer; the RF load attached to the EUT antenna terminal is 50 Ohm; the path loss as the factor is calibrated to correct the reading. Make the measurement with the spectrum analyzer's resolution bandwidth (RBW) = 100 kHz. In order to make an accurate measurement, set the span greater than RBW.

5.4 EUT OPERATION CONDITIONS

Please refer to section 3.4 of this report.

5.5 TEST RESULTS

For the measurement records, refer to the appendix I.



6. POWER SPECTRAL DENSITY TEST

6.1 LIMIT

FCC Part 15.247, Subpart C				
Section	Test Item	Limit	Frequency Range (MHz)	Result
15.247(e)	Power Spectral Density	≤ 8 dBm (RBW ≥ 3 KHz)	2400-2483.5	PASS

6.2 TEST PROCEDURE

1. Set analyzer center frequency to DTS channel center frequency.
2. Set the span to 1.5 times the DTS channel bandwidth.
3. Set the RBW to: $100 \text{ kHz} \geq \text{RBW} \geq 3 \text{ kHz}$.
4. Set the VBW $\geq 3 \times \text{RBW}$.
5. Detector = peak.
6. Sweep time = auto couple.
7. Trace mode = max hold.
8. Allow trace to fully stabilize.
9. Use the peak marker function to determine the maximum amplitude level.
10. If measured value exceeds limit, reduce RBW (no less than 3 kHz) and repeat.

6.3 TEST SETUP



6.4 EUT OPERATION CONDITIONS

Please refer to section 3.4 of this report.

6.5 TEST RESULTS

For the measurement records, refer to the appendix I.



7. BANDWIDTH TEST

7.1 LIMIT

FCC Part 15.247, Subpart C				
Section	Test Item	Limit	Frequency Range (MHz)	Result
15.247(a)(2)	Bandwidth	$\geq 500\text{KHz}$ (6dB bandwidth)	2400-2483.5	PASS

7.2 TEST PROCEDURE

The automatic bandwidth measurement capability of an instrument may be employed using the X dB bandwidth mode with X set to 6 dB, if the functionality described above (i.e., RBW = 100 kHz, VBW \geq 3RBW, peak detector with maximum hold) is implemented by the instrumentation function. When using this capability, care shall be taken so that the bandwidth measurement is not influenced by any intermediate power nulls in the fundamental emission that might be ≥ 6 dB.

7.3 TEST SETUP



7.4 EUT OPERATION CONDITIONS

Please refer to section 3.4 of this report.

7.5 TEST RESULTS

For the measurement records, refer to the appendix I.



8. PEAK OUTPUT POWER TEST

8.1 LIMIT

FCC Part 15.247, Subpart C				
Section	Test Item	Limit	Frequency Range (MHz)	Result
15.247(b)(3)	Output Power	1 watt or 30dBm	2400-2483.5	PASS

8.2 TEST PROCEDURE

One of the following procedures may be used to determine the maximum peak conducted output power of a DTS EUT.

RBW \geq DTS bandwidth

The following procedure shall be used when an instrument with a resolution bandwidth that is greater than the DTS bandwidth is available to perform the measurement:

- Set the RBW \geq DTS bandwidth.
- Set VBW \geq [3 \times RBW].
- Set span \geq [3 \times RBW].
- Sweep time = auto couple.
- Detector = peak.
- Trace mode = max hold.
- Allow trace to fully stabilize.
- Use peak marker function to determine the peak amplitude level.

Integrated band power method:

The following procedure can be used when the maximum available RBW of the instrument is less than the

DTS bandwidth:

- Set the RBW = 1 MHz.
- Set the VBW \geq [3 \times RBW].
- Set the span \geq [1.5 \times DTS bandwidth].
- Detector = peak.
- Sweep time = auto couple.
- Trace mode = max hold.
- Allow trace to fully stabilize.
- Use the instrument's band/channel power measurement function with the band limits set equal to the DTS bandwidth edges (for some instruments, this may require a manual override to select the peak detector). If the instrument does not have a band power function, then sum the spectrum levels (in linear power units) at intervals equal to the RBW extending across the DTS channel bandwidth.

PKPM1 Peak power meter method:

The maximum peak conducted output power may be measured using a broadband peak RF power meter. The power meter shall have a video bandwidth that is greater than or equal to the DTS bandwidth and shall use a fast-responding diode detector.

8.3 TEST SETUP

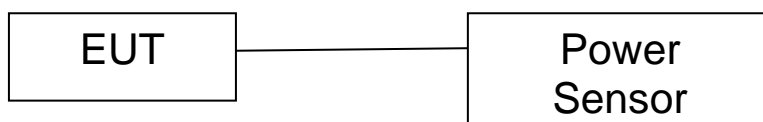

8.4 EUT OPERATION CONDITIONS

Please refer to section 3.4 of this report.

8.5 TEST RESULTS

For the measurement records, refer to the appendix I.



9. ANTENNA REQUIREMENT

9.1 STANDARD REQUIREMENT

15.203 requirement: For intentional device, according to 15.203: an intentional radiator shall be designed to ensure that no antenna other than that furnished by the responsible party shall be used with the device.

9.2 EUT ANTENNA

The EUT antenna is PCB Antenna. It comply with the standard requirement.



APPENDIX I - TEST RESULTS

Duty Cycle

Condition	Mode	Frequency (MHz)	Antenna	Duty Cycle (%)	Correction Factor (dB)	1/T (kHz)
NVNT	BLE 1M	2402	Ant1	100	0	0.01
NVNT	BLE 1M	2440	Ant1	100	0	0.01
NVNT	BLE 1M	2480	Ant1	100	0	0.01

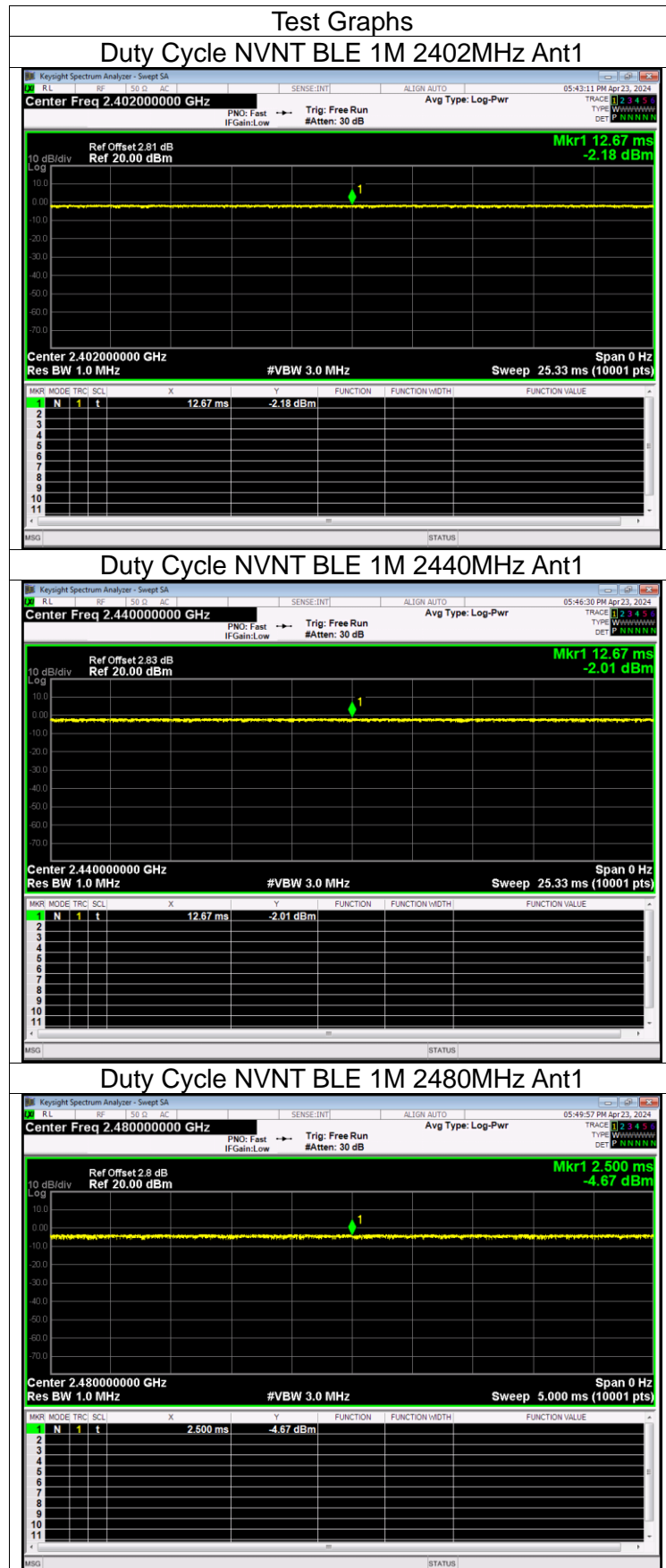



Maximum Peak Conducted Output Power

Condition	Mode	Frequency (MHz)	Antenna	Conducted Power (dBm)	Limit (dBm)	Verdict
NVNT	BLE 1M	2402	Ant1	-1.22	30	Pass
NVNT	BLE 1M	2440	Ant1	-1.7	30	Pass
NVNT	BLE 1M	2480	Ant1	-3.04	30	Pass



-6dB Bandwidth

Condition	Mode	Frequency (MHz)	Antenna	-6 dB Bandwidth (MHz)	Limit -6 dB Bandwidth (MHz)	Verdict
NVNT	BLE 1M	2402	Ant1	0.717	0.5	Pass
NVNT	BLE 1M	2440	Ant1	0.703	0.5	Pass
NVNT	BLE 1M	2480	Ant1	0.702	0.5	Pass

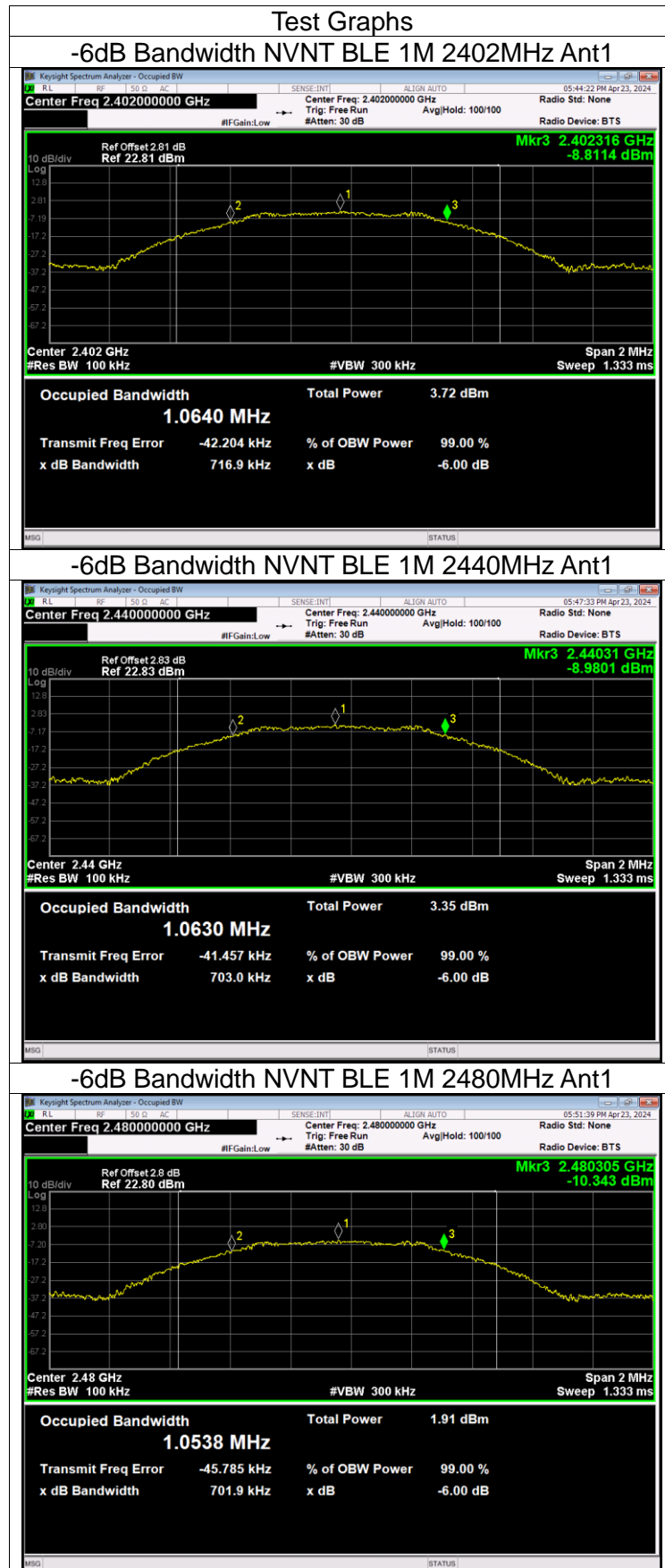



Occupied Channel Bandwidth

Condition	Mode	Frequency (MHz)	Antenna	99% OBW (MHz)
NVNT	BLE 1M	2402	Ant1	1.063
NVNT	BLE 1M	2440	Ant1	1.054
NVNT	BLE 1M	2480	Ant1	1.061

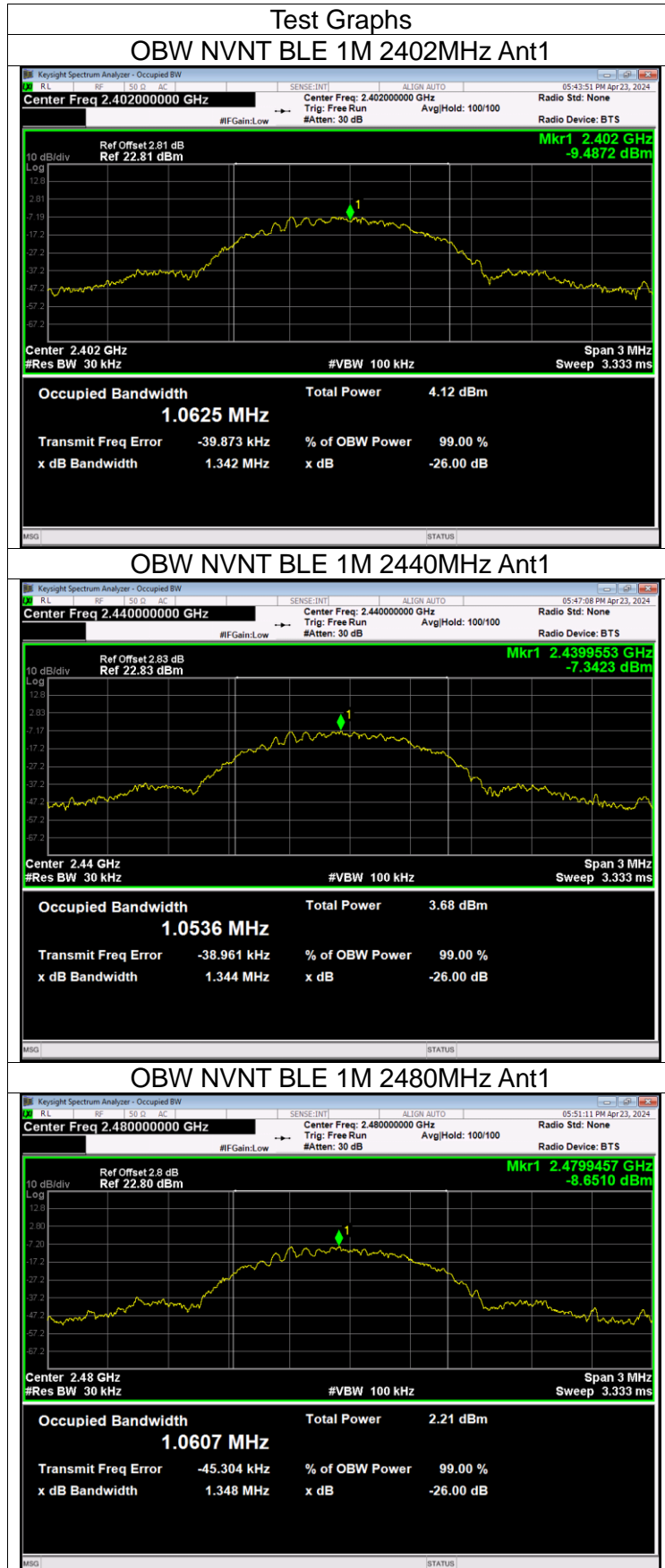



Maximum Power Spectral Density Level

Condition	Mode	Frequency (MHz)	Antenna	Conducted PSD (dBm/3kHz)	Limit (dBm/3kHz)	Verdict
NVNT	BLE 1M	2402	Ant1	-15.34	8	Pass
NVNT	BLE 1M	2440	Ant1	-15.71	8	Pass
NVNT	BLE 1M	2480	Ant1	-17.67	8	Pass

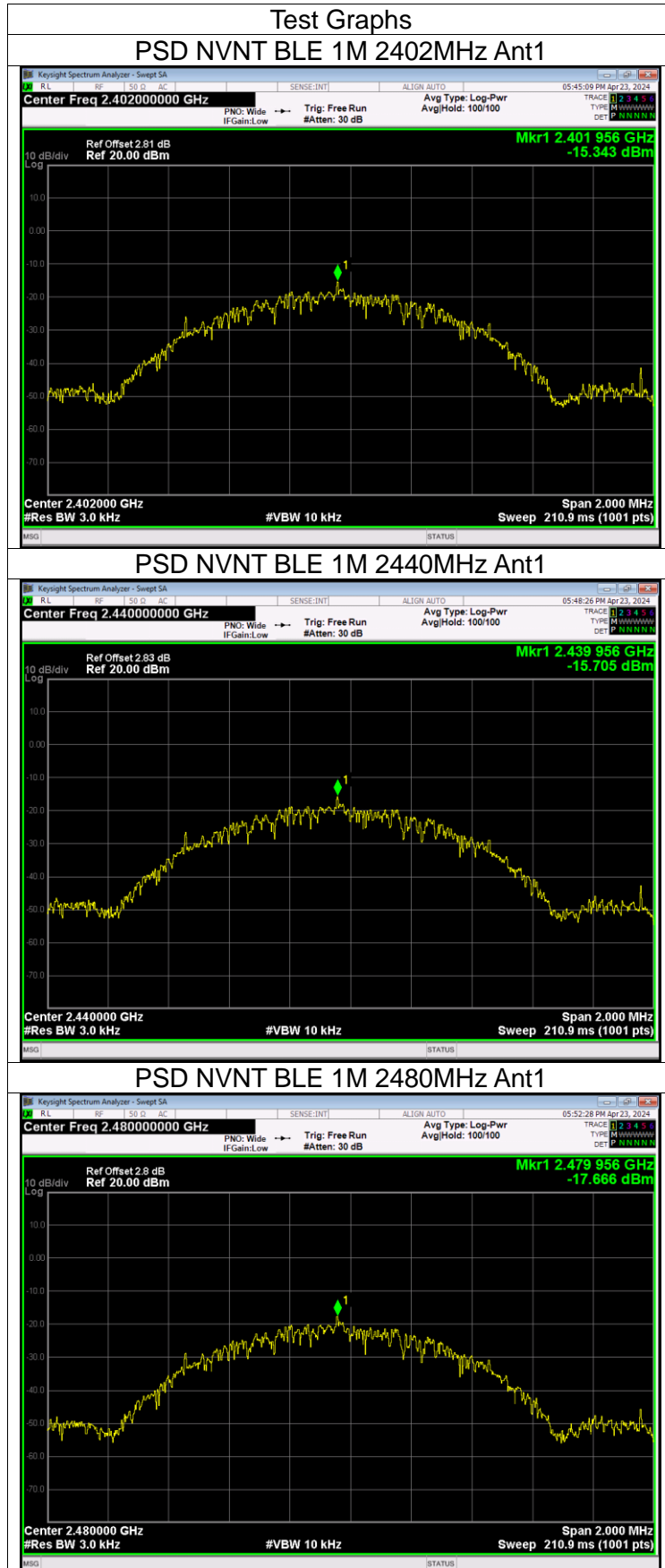



Band Edge

Condition	Mode	Frequency (MHz)	Antenna	Max Value (dBc)	Limit (dBc)	Verdict
NVNT	BLE 1M	2402	Ant1	-40.19	-20	Pass
NVNT	BLE 1M	2480	Ant1	-47.02	-20	Pass

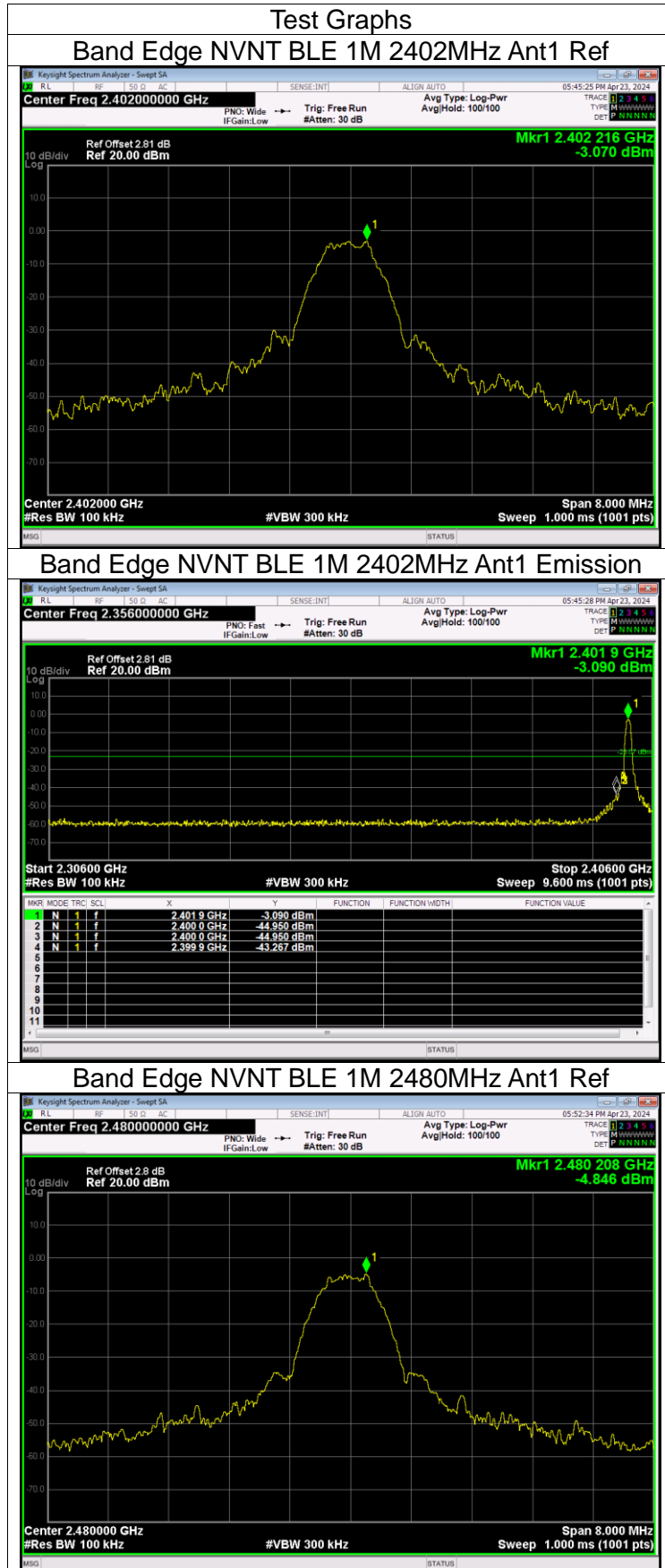

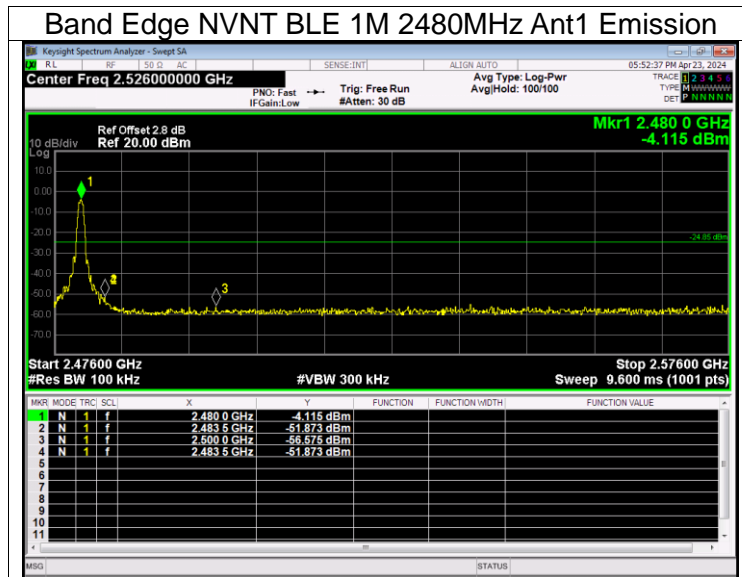



Conducted RF Spurious Emission

Condition	Mode	Frequency (MHz)	Antenna	Max Value (dBc)	Limit (dBc)	Verdict
NVNT	BLE 1M	2402	Ant1	-36.69	-20	Pass
NVNT	BLE 1M	2440	Ant1	-38.74	-20	Pass
NVNT	BLE 1M	2480	Ant1	-39.26	-20	Pass



Test Graphs

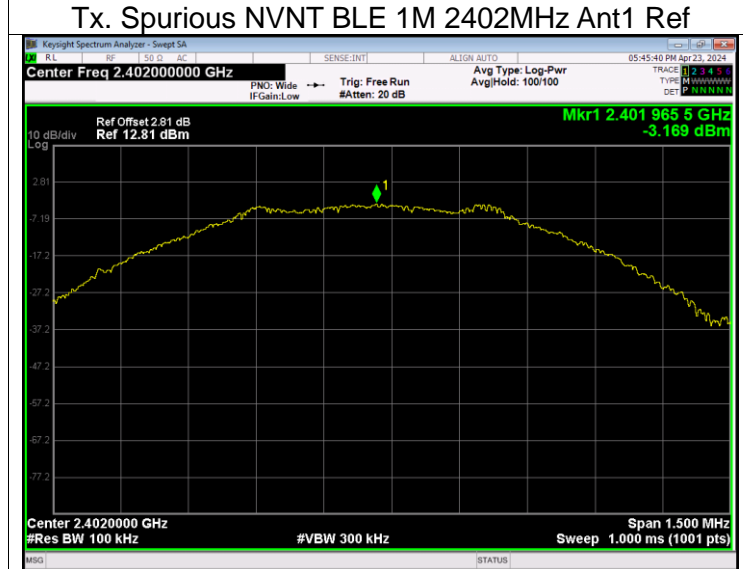

Tx. Spurious NVNT BLE 1M 2402MHz Ant1 Emission

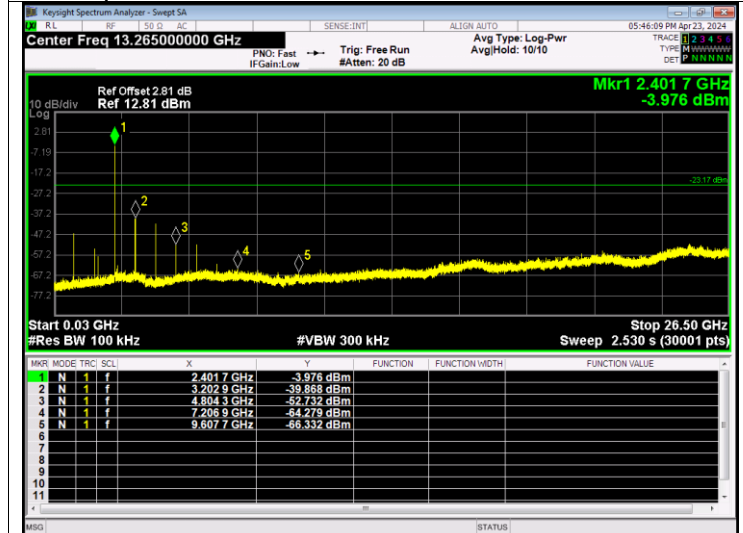

Tx. Spurious NVNT BLE 1M 2440MHz Ant1 Ref

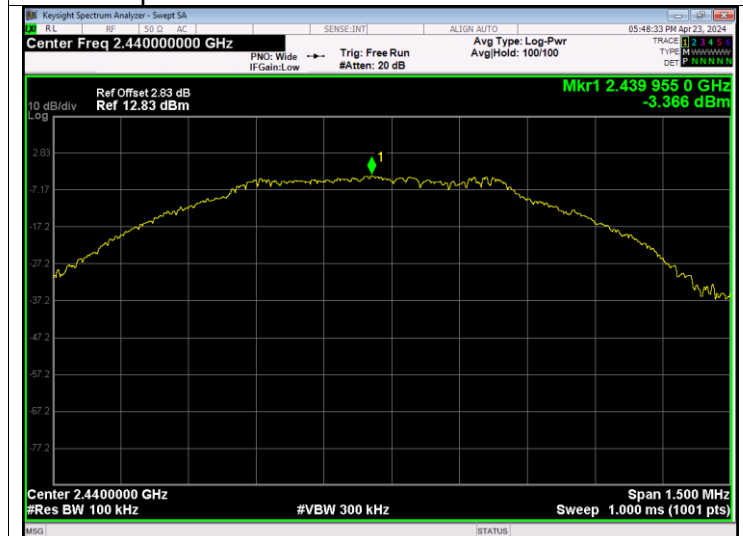

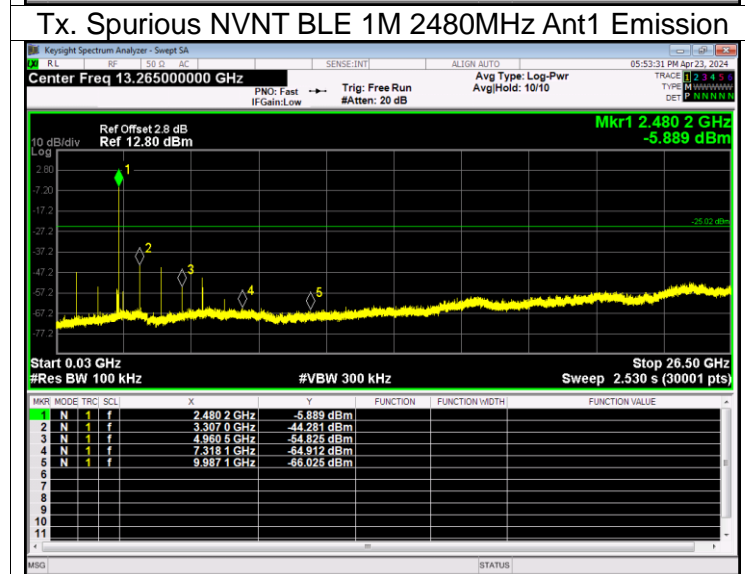
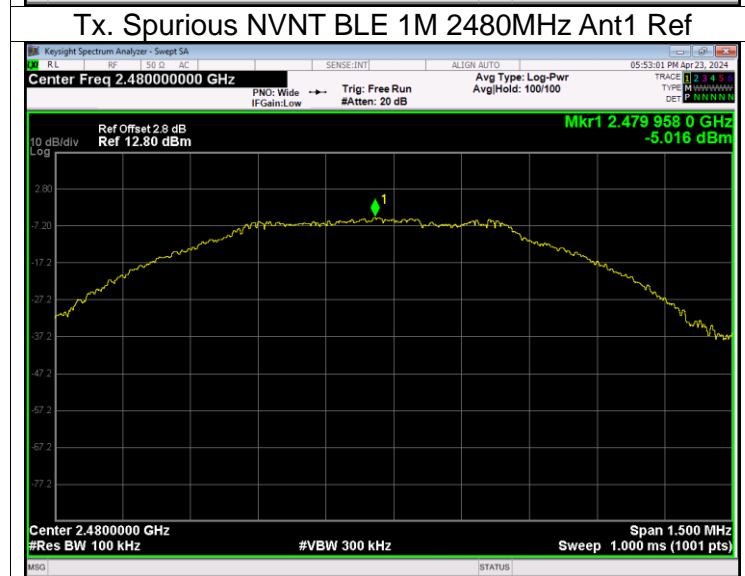
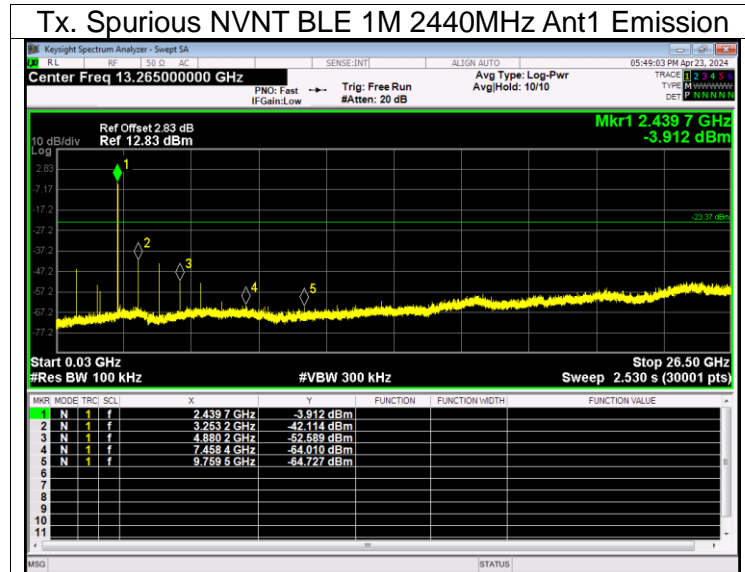

*****END OF THE REPORT*****