

TEST REPORT

Product Name : Nighthunter S35
Model Number : Nighthunter S35
FCC ID : 2AKU5ZG36

Prepared for : Wuhan Guide Sensmart Tech Co., Ltd
Address : NO.29, Gaoxin 3rd Road, Donghu New-tech Development Zone, Wuhan City, Hubei, P.R.China

Prepared by : EMTEK (SHENZHEN) CO., LTD.
Address : Building 69, Majialong Industry Zone, Nanshan District, Shenzhen, Guangdong, China

Tel: (0755) 26954280
Fax: (0755) 26954282

Report Number : ENS2401090232W00501R
Date(s) of Tests : January 19, 2024 to March 29, 2024
Date of issue : March 30, 2024

TEST RESULT CERTIFICATION

Applicant : Wuhan Guide Sensmart Tech Co., Ltd
Address : NO.29, Gaoxin 3rd Road, Donghu New-tech Development Zone, Wuhan City, Hubei, P.R.China
Manufacturer : Wuhan Guide Sensmart Tech Co., Ltd
Address : NO.29, Gaoxin 3rd Road, Donghu New-tech Development Zone, Wuhan City, Hubei, P.R.China
EUT : Nighthunter S35
Model Name : Nighthunter S35
Trademark : Guide

Measurement Procedure Used:

APPLICABLE STANDARDS	
STANDARD	TEST RESULT
FCC 47 CFR Part 2 , Subpart J FCC 47 CFR Part 15 , Subpart C	PASS

The above equipment was tested by EMTEK (SHENZHEN) CO., LTD. The test data, data evaluation, test procedures, and equipment configurations shown in this report were made in accordance with the procedures given in ANSI C63.10 (2013) and the energy emitted by the sample EUT tested as described in this report is in compliance with the requirements of FCC Rules Part 2 and Part 15.247

The test results of this report relate only to the tested sample identified in this report.

Date of Test : January 19, 2024 to March 29, 2024

Prepared by : 
Una Yu /Editor

Reviewer : 
Joe Xia/Supervisor

Approve & Authorized Signer : 
Lisa Wang/Manager



Modified History

Version	Report No.	Revision Date	Summary
V1.0	ENS2401090232W00501R	/	Original Report



TABLE OF CONTENTS

1 EUT TECHNICAL DESCRIPTION	5
2 SUMMARY OF TEST RESULT	6
3 TEST METHODOLOGY	7
3.1 GENERAL DESCRIPTION OF APPLIED STANDARDS	7
3.2 MEASUREMENT EQUIPMENT USED	7
3.3 DESCRIPTION OF TEST MODES.....	8
4 FACILITIES AND ACCREDITATIONS	9
4.1 FACILITIES	9
4.2 EQUIPMENT	9
4.3 LABORATORY ACCREDITATIONS AND LISTINGS	9
5 TEST SYSTEM UNCERTAINTY	10
6 SETUP OF EQUIPMENT UNDER TEST	11
6.1 RADIO FREQUENCY TEST SETUP 1	11
6.2 RADIO FREQUENCY TEST SETUP 2	11
6.3 CONDUCTED EMISSION TEST SETUP	14
6.4 BLOCK DIAGRAM CONFIGURATION OF TEST SYSTEM	15
6.5 SUPPORT EQUIPMENT	15
7 TEST REQUIREMENTS	16
7.1 MINIMUM (6DB) OCCUPIED BANDWIDTH	16
7.2 MAXIMUM PEAK CONDUCTED OUTPUT POWER	20
7.3 MAXIMUM POWER SPECTRAL DENSITY	24
7.4 UNWANTED SPURIOUS EMISSIONS	28
7.5 RADIATED EMISSION.....	41
7.6 CONDUCTED EMISSION TEST	53
7.7 ANTENNA APPLICATION	56

1 EUT TECHNICAL DESCRIPTION

Characteristics	Description
Product	Nighthunter S35
Model Number	Nighthunter S35
Sample Number	2#
IEEE 802.11 WLAN Mode Supported	<input checked="" type="checkbox"/> 802.11b <input checked="" type="checkbox"/> 802.11g <input checked="" type="checkbox"/> 802.11n(20MHz channel bandwidth)
Modulation	DSSS with DBPSK/DQPSK/CCK for 802.11b; OFDM with BPSK/QPSK/16QAM/64QAM for 802.11g/n;
Operating Frequency Range	<input checked="" type="checkbox"/> 2412-2462MHz for 802.11b/g/n(HT20);
Number of Channels	<input checked="" type="checkbox"/> 11 channels for 802.11b/g/n(HT20);
Transmit Power Max	18.08 dBm
Antenna Type	Internal Antenna
Antenna Gain	2.0 dBi
Power Supply	DC 5V from Adapter DC 7.2V from internal battery
Date of Received	January 18, 2024

Note: for more details, please refer to the user's manual of the EUT.

2 SUMMARY OF TEST RESULT

FCC Part Clause	Test Parameter	Verdict	Remark
15.247(a)(2)	DTS (6dB) Bandwidth	PASS	
15.247(b)(3)	Maximum Peak Conducted Output Power	PASS	
15.247(e)	Maximum Power Spectral Density Level	PASS	
15.247(d)	Unwanted Emission Into Non-Restricted Frequency Bands	PASS	
15.247(d) 15.209	Unwanted Emission Into Restricted Frequency Bands (conducted)	PASS	
15.247(d) 15.209	Radiated Spurious Emission	PASS	
15.207	Conducted Emission Test	PASS	
15.247(b)	Antenna Application	PASS	
	NOTE1: N/A (Not Applicable) NOTE2: According to FCC OET KDB 558074, the report use radiated measurements in the restricted frequency bands. In addition, the radiated test is also performed to ensure the emissions emanating from the device cabinet also comply with the applicable limits.		

RELATED SUBMITTAL(S) / GRANT(S):

This submittal(s) (test report) is intended for FCC ID: 2AKU5ZG36 filing to comply with Section 15.247 of the FCC Part 15, Subpart C Rules.

3 TEST METHODOLOGY

3.1 GENERAL DESCRIPTION OF APPLIED STANDARDS

According to its specifications, the EUT must comply with the requirements of the following standards:

FCC 47 CFR Part 2, Subpart J

FCC 47 CFR Part 15, Subpart C

FCC KDB 558074 D01 15.247 Meas Guidance v05r02

FCC KDB 662911 D01 Multiple Transmitter Output v02r01

3.2 MEASUREMENT EQUIPMENT USED

Conducted Emission Test Equipment

Equipment	Manufacturer	Model No.	Serial No.	Last Cal.	Cal. Interval
EMI Test Receiver	Rohde & Schwarz	ESCI	101045	2023/5/13	1 Year
AMN	Schwarzbeck	NNLK 8129	8129203	2023/5/13	1 Year
50Ω Coaxial Switch	Anritsu	MP59B	M20531	N/A	1 Year
Pulse Limiter	Rohde & Schwarz	ESH3-Z2	100107	2023/5/13	1 Year
High Voltage Probe	SCHWARZBECK	TK9422	9422-130	2023/5/10	1 Year
AMN	Rohde & Schwarz	ESH3-Z5	100191	2023/5/10	1 Year

For Spurious Emissions Test

Equipment	Manufacturer	Model No.	Serial No.	Last Cal.	Cal. Interval
EMI Test Receiver	Rohde & Schwarz	ESCI	101414	2023/5/13	1 Year
Pre-Amplifier	HP	8447F	2944A07999	2023/5/13	1 Year
Bilog Antenna	Schwarzbeck	VULB9163	712	2023/7/2	2 Year
Loop Antenna	Schwarzbeck	FMZB1519	1519-012	2023/5/12	2 Year
Horn Antenna	Schwarzbeck	BBHA 9170	9170-399	2023/5/12	2 Year
Horn Antenna	Schwarzbeck	BBHA9120D	9120D-1198	2023/6/2	2 Year
Cable	Schwarzbeck	AK9513	ACRX1	2023/5/13	1 Year
Cable	Rosenberger	N/A	FP2RX2	2023/5/13	2 Year
Cable	Schwarzbeck	AK9513	CRPX1	2023/5/13	2 Year
Cable	Schwarzbeck	AK9513	CRRX2	2023/5/13	1 Year

For other test items:

Equipment	Manufacturer	Model No.	Serial No.	Last Cal.	Cal. Interval
Wideband Radio Communication Tester	R&S	CMW500	171168	2023/9/14	1Year
Spectrum Analyzer	R&S	FSV3044	101289	2023/9/14	1Year
Analog Signal Generator	R&S	SMB100A	183237	2023/9/16	1Year
Vector Signal Generator	R&S	SMM100A	101808	2023/9/16	1Year
RF Control Unit(Power Meter)	Tonscend	JS0806-2	22C8060567	2023/9/14	1Year
Temperature&Humidity Chamber	ESPEC	EL-02KA	12107166	2023/5/10	1 Year

Remark: Each piece of equipment is scheduled for calibration once a year.

3.3 DESCRIPTION OF TEST MODES

The EUT has been tested under its typical operating condition.

The EUT configuration for testing is installed on RF field strength measurement to meet the Commissions requirement and operating in a manner which intends to maximize its emission characteristics in a continuous normal application.

The Transmitter was operated in the normal operating mode. The TX frequency was fixed which was for the purpose of the measurements.

Test of channel included the lowest and middle and highest frequency to perform the test, then record on this report.

Those data rates (802.11b: 1 Mbps; 802.11g: 6 Mbps; 802.11n : MCS0) were used for all test.

Pre-defined engineering program for regulatory testing used to control the EUT for staying in continuous transmitting and receiving mode is programmed.

Frequency and Channel list for 802.11 b/g/n(HT20):

Channel	Frequency (MHz)	Channel	Frequency (MHz)	Channel	Frequency (MHz)
1	2412	5	2432	9	2452
2	2417	6	2437	10	2457
3	2422	7	2442	11	2462
4	2427	8	2447		

Test Frequency and Channel for 802.11 b/g/n(HT20):

Lowest Frequency		Middle Frequency		Highest Frequency	
Channel	Frequency (MHz)	Channel	Frequency (MHz)	Channel	Frequency (MHz)
1	2412	6	2437	11	2462

4 FACILITIES AND ACCREDITATIONS

4.1 FACILITIES

All measurement facilities used to collect the measurement data are located at:

EMTEK (Shenzhen) Co., Ltd.

Building 69, Majialong Industry Zone District, Nanshan District, Shenzhen, China

The sites are constructed in conformance with the requirements of ANSI C63.7, ANSI C63.4 and CISPR Publication 22.

4.2 EQUIPMENT

Radiated emissions are measured with one or more of the following types of linearly polarized antennas: tuned dipole, biconical, log periodic, bi-log, and/or ridged waveguide, horn. Spectrum analyzers with preselectors and quasi-peak detectors are used to perform radiated measurements.

Conducted emissions are measured with Line Impedance Stabilization Networks and EMI Test Receivers.

Calibrated wideband preamplifiers, coaxial cables, and coaxial attenuators are also used for making measurements.

All receiving equipment conforms to CISPR Publication 16-1, "Radio Interference Measuring Apparatus and Measurement Methods."

4.3 LABORATORY ACCREDITATIONS AND LISTINGS

Site Description	
EMC Lab.	<p>Accredited by CNAS The Certificate Registration Number is L2291. The Laboratory has been assessed and proved to be in compliance with CNAS-CL01 (identical to ISO/IEC 17025:2017)</p> <p>Accredited by FCC Designation Number: CN1204 Test Firm Registration Number: 882943</p> <p>Accredited by A2LA The Certificate Number is 4321.01.</p> <p>Accredited by Industry Canada The Conformity Assessment Body Identifier is CN0008</p>
Name of Firm	: EMTEK (SHENZHEN) CO., LTD.
Site Location	: Building 69, Majialong Industry Zone, Nanshan District, Shenzhen, Guangdong, China

5 TEST SYSTEM UNCERTAINTY

The following measurement uncertainty levels have been estimated for tests performed on the apparatus:

Parameter	Uncertainty
Radio Frequency	$\pm 1 \times 10^{-5}$
Maximum Peak Output Power Test	$\pm 1.0\text{dB}$
Conducted Emissions Test	$\pm 2.0\text{dB}$
Radiated Emission Test	$\pm 2.0\text{dB}$
Power Density	$\pm 2.0\text{dB}$
Occupied Bandwidth Test	$\pm 1.0\text{dB}$
Band Edge Test	$\pm 3\text{dB}$
All emission, radiated	$\pm 3\text{dB}$
Antenna Port Emission	$\pm 3\text{dB}$
Temperature	$\pm 0.5^\circ\text{C}$
Humidity	$\pm 3\%$

Measurement Uncertainty for a level of Confidence of 95%

6 SETUP OF EQUIPMENT UNDER TEST

6.1 RADIO FREQUENCY TEST SETUP 1

The WLAN component's antenna ports(s) of the EUT are connected to the measurement instrument per an appropriate attenuator. The EUT is controlled by PC/software to emit the specified signals for the purpose of measurements.

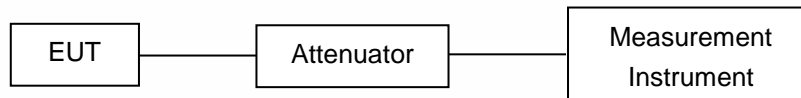

6.2 RADIO FREQUENCY TEST SETUP 2

The test site semi-anechoic chamber has met the requirement of NSA tolerance 4 dB according to the standards: ANSI C63.10. The test distance is 3m. The setup is according to the requirements in Section 13.1.4.1 of ANSI C63.10-2013 and CAN/CSA-CEI/IEC CISPR 22.

The maximal emission value is acquired by adjusting the antenna height, polarisation and turntable azimuth. Normally, the height range of antenna is 1 m to 4 m, the azimuth range of turntable is 0° to 360°, and the receive antenna has two polarizations Vertical (V) and Horizontal (H).

Below 30MHz:

The EUT is placed on a turntable 0.8 meters above the ground in the chamber, 3 meter away from the antenna (loop antenna). The Antenna should be positioned with its plane vertical at the specified distance from the EUT and rotated about its vertical axis for maximum response at each azimuth about the EUT. The center of the loop shall be 1 m above the ground. For certain applications, the loop antenna plane may also need to be positioned horizontally at the specified distance from the EUT.

Above 30MHz:

The EUT is placed on a turntable 0.8 meters above the ground in the chamber, 3 meter away from the antenna. The maximal emission value is acquired by adjusting the antenna height, polarisation and turntable azimuth. Normally, the height range of antenna is 1 m to 4 m, the azimuth range of turntable is 0° to 360°, and the receive antenna has two polarizations Vertical (V) and Horizontal (H).

Above 1GHz:

The EUT is placed on a turntable 1.5 meters above the ground in the chamber, 3 meter away from the antenna. The maximal emission value is acquired by adjusting the antenna height, polarisation and turntable azimuth. Normally, the height range of antenna is 1 m to 4 m, the azimuth range of turntable is 0° to 360°, and the receive antenna has two polarizations Vertical (V) and Horizontal (H).

Measurements shall be taken, using the following steps, at a test site that has been validated using the procedures of ANSI C63.4 or the latest CISPR 16-1-4 for measurements above 1 GHz, so as to simulate a near free-space environment (see RSS-Gen for applicable versions of ANSI and CISPR standards).

- (1) Line the ground plane with absorbers between the transmitter and the receive antenna to minimize reflections. The absorbers used should have a minimum-rated attenuation of 20 dB through the measurement frequency range of interest. The absorbers shall be positioned to replicate the layout used when compliance with the applicable acceptability criterion was achieved, as set forth in the aforementioned standards on site validation.
- (2) Set the height of the receive antenna to 1.5 m. The receive antenna must be one that was designed and fabricated to operate over the entire frequency range of interest, for example, an appropriate standard gain horn.
- (3) The distance between the receive antenna and the radiating source shall be sufficient in order to ensure far-field conditions.
- (4) Mount the transmitter at a height of 1.5 m.
- (5) Configure the device under test (DUT) to produce the maximum power spectral density as measured while assessing compliance with Section 6.2.2 (i.e. channel frequency, modulation type and data rate). If the DUT is equipped with a detachable antenna and the antenna is intended for remote installation (i.e.

tower-mounted), the DUT may be substituted with a suitable signal generator. The level and frequency settings on the generator shall be set so as to reproduce the maximum power spectral density, measured within a 1 MHz bandwidth, obtained while assessing compliance to Section 6.2.2.

(6) Position the transmitter or the radiating antenna so that elevation pattern measurements can be taken.

(7) Find the 0° reference point in the horizontal plane.

(8) Care should be taken when positioning the receive antenna to avoid cross-polarization. Antennas of known mounting polarization should be assessed with the receive antenna oriented in the same polarity. If the polarization of the transmit antenna is unknown or the transmit antenna can be mounted in either polarization, e.i.r.p. measurements should be performed to find which mounting polarity provides the highest e.i.r.p. value. Testing shall be carried out with the receive antenna and the DUT mounted in each polarity.

(9) The emission shall be centred on the display of the spectrum analyzer with the following settings:

i. If the power spectral density of the DUT was assessed with a peak detector and the antenna cannot be detached from the DUT, the spectrum analyzer shall be set to a peak detector with a resolution bandwidth and video bandwidth of 1 MHz.

ii. If the power spectral density of the DUT was assessed using a sample detector with power averaging and the antenna cannot be detached from the DUT, the spectrum analyzer shall be set to a sample detector, configured to produce 100 power averages and set with a resolution bandwidth, as well as a video bandwidth of 1 MHz.

iii. If the antenna can be detached from the DUT, a continuous wave (CW) signal equal to that of the power spectral density measurement may be used, the spectrum analyzer shall be set to peak detector with a resolution bandwidth and video bandwidth of 1 MHz.

(10) Rotate the turntable 360° recording the field strength at each step. Throughout the main beam of the antenna, the step size shall be kept to a maximum of 1°.

Once outside the main beam of the antenna, the maximum step size shall be as follows, when compared to the requirements of Section 6.2.2:

i. Between 0° and 8°, maximum step size of 2°;

ii. Between 8° and 40°, maximum step size of 4°;

iii. Between 40° and 45°, maximum step size of 1°;

iv. Between 45° and 90°, maximum step size of 5°.

Once the mask reaches 90°, the mask will be inverted and the step size will follow in the same manner as above.

For the purpose of this procedure, the main beam of the antenna is defined as the 3 dB beamwidth.

(11) Convert the measured field strength values in terms of e.i.r.p. density (dBW/1 MHz) using the following equation:

$$\text{e.i.r.p. density (dBW/MHz)} = 10 \log((E \cdot r)^2 / 30)$$

E = field strength in V/m

r = measurement distance in metres

(12) Plot the results against the emission mask with reference to the horizontal plane.

(13) Using the plot, the 0° can be rotated to determine the worst-case installation tilt angle.

(14) Testing shall be performed using the highest gain antenna for every antenna type, if applicable.

(15) Antenna type(s), antenna model number(s), and worst-case tilt angle(s) necessary to remain compliant with the elevation mask requirement set forth in Section 6.2.2(3) of RSS-247 shall be clearly indicated in the user manual.

The following figure is an example of a polar elevation mask measured using the Method 1 reference to dB μ V/m at 3 m.

(a) Radiated Emission Test Set-Up, Frequency Below 30MHz

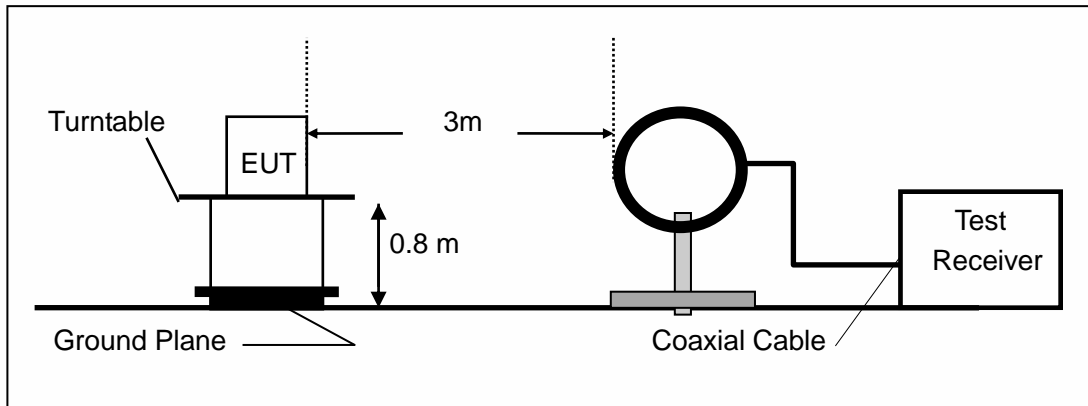

(b) Radiated Emission Test Set-Up, Frequency Below 1000MHz

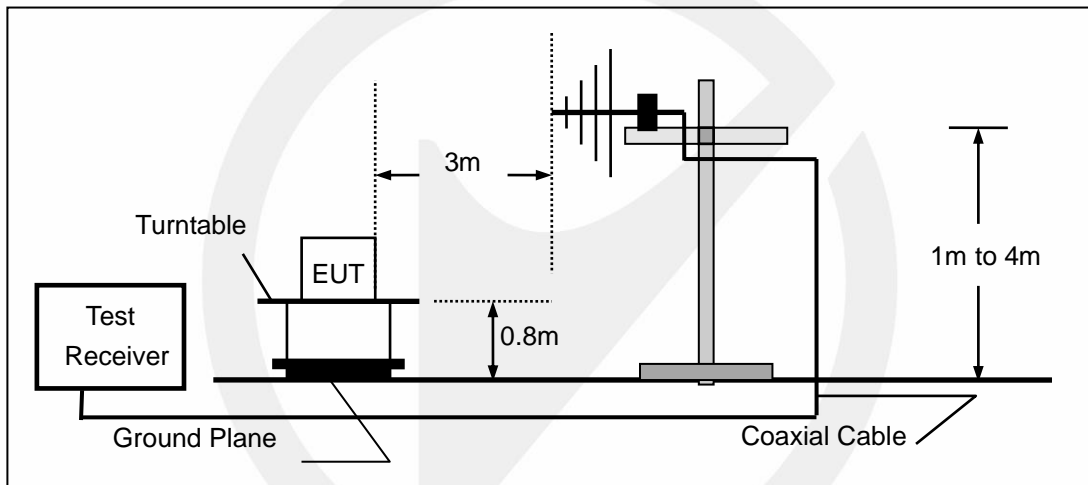

(c) Radiated Emission Test Set-Up, Frequency above 1000MHz

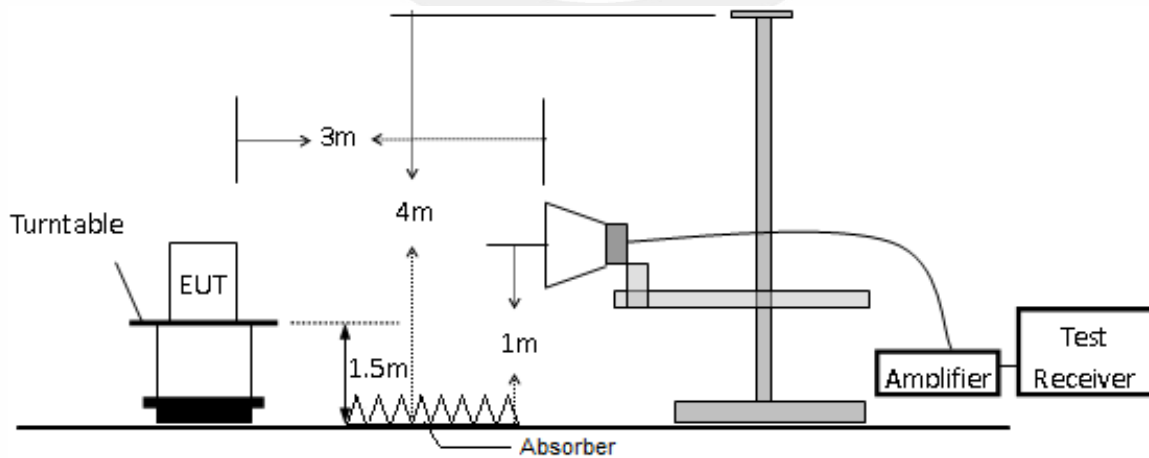

6.3 CONDUCTED EMISSION TEST SETUP

The mains cable of the EUT (maybe per AC/DC Adapter) must be connected to LISN. The LISN shall be placed 0.8 m from the boundary of EUT and bonded to a ground reference plane for LISN mounted on top of the ground reference plane. This distance is between the closest points of the LISN and the EUT. All other units of the EUT and associated equipment shall be at least 0.8m from the LISN.

Ground connections, where required for safety purposes, shall be connected to the reference ground point of the LISN and, where not otherwise provided or specified by the manufacturer, shall be of same length as the mains cable and run parallel to the mains connection at a separation distance of not more than 0.8 m.

According to the requirements in Section 13.1.4.1 of ANSI C63.10-2013 Conducted emissions from the EUT measured in the frequency range between 0.15 MHz and 30 MHz using CISPR Quasi-Peak and average detector mode.

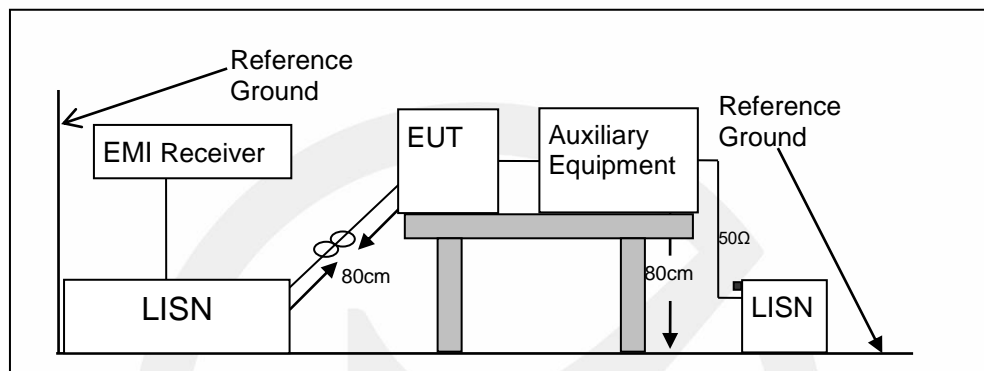

6.4 BLOCK DIAGRAM CONFIGURATION OF TEST SYSTEM

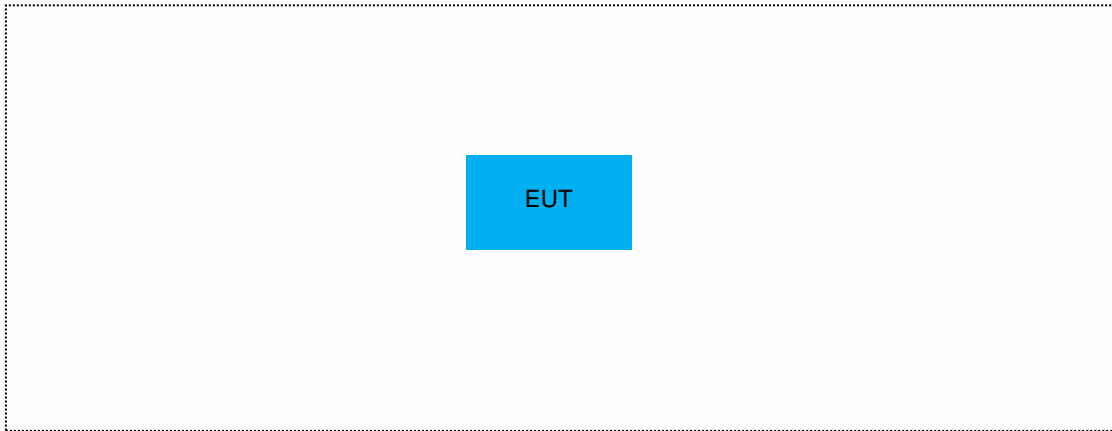

6.5 SUPPORT EQUIPMENT

EUT Cable List and Details			
Cable Description	Length (m)	Shielded/Unshielded	With / Without Ferrite
/	/	/	/

Auxiliary Cable List and Details			
Cable Description	Length (m)	Shielded/Unshielded	With / Without Ferrite
/	/	/	/

Auxiliary Equipment List and Details			
Description	Manufacturer	Model	Serial Number
/	/	/	/

Notes:

1. All the equipment/cables were placed in the worst-case configuration to maximize the emission during the test.
2. Grounding was established in accordance with the manufacturer's requirements and conditions for the intended use.

11B_Ant1_2412

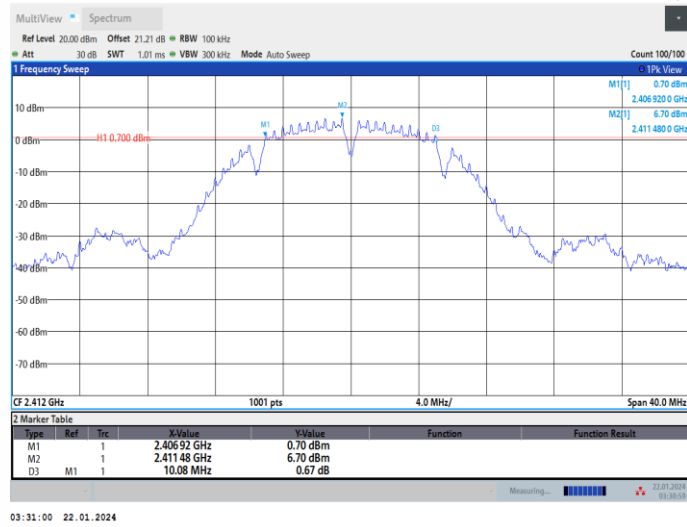

11B_Ant1_2437

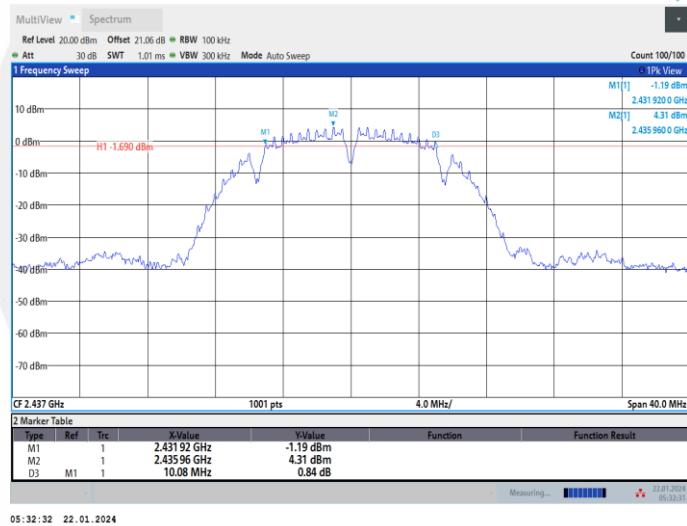

11B_Ant1_2462



11G_Ant1_2412

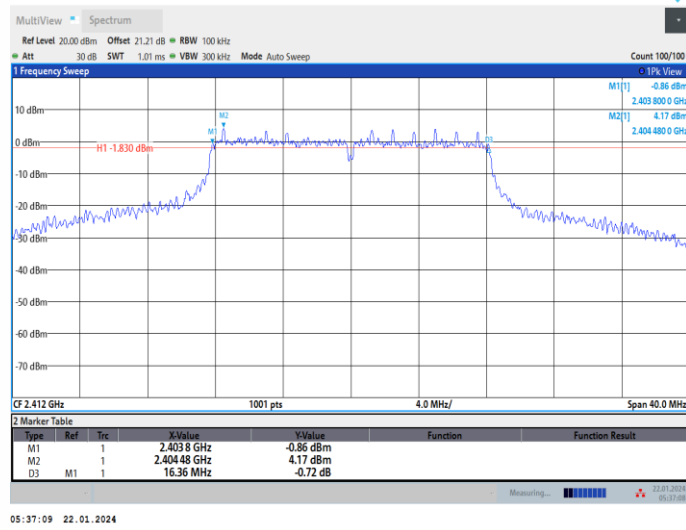

11G_Ant1_2437

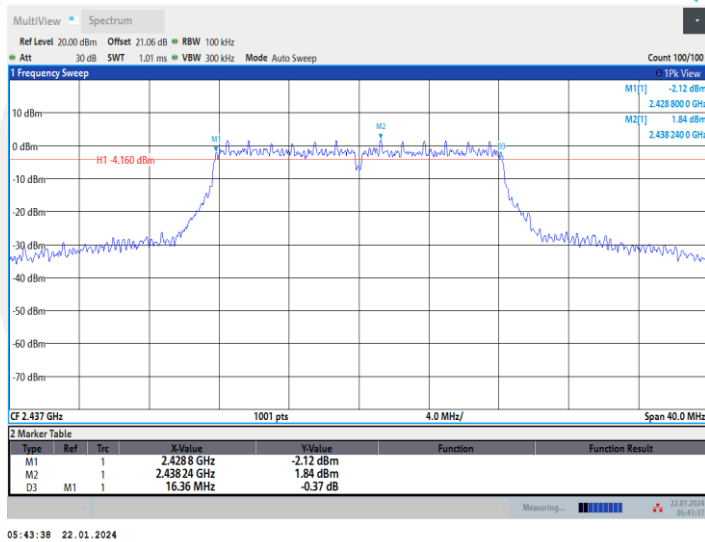

11G_Ant1_2462

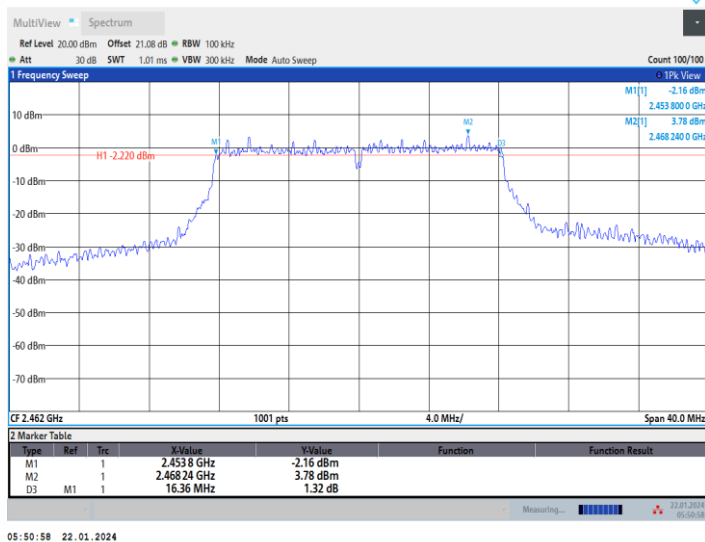

11N20SISO_Ant1_2412

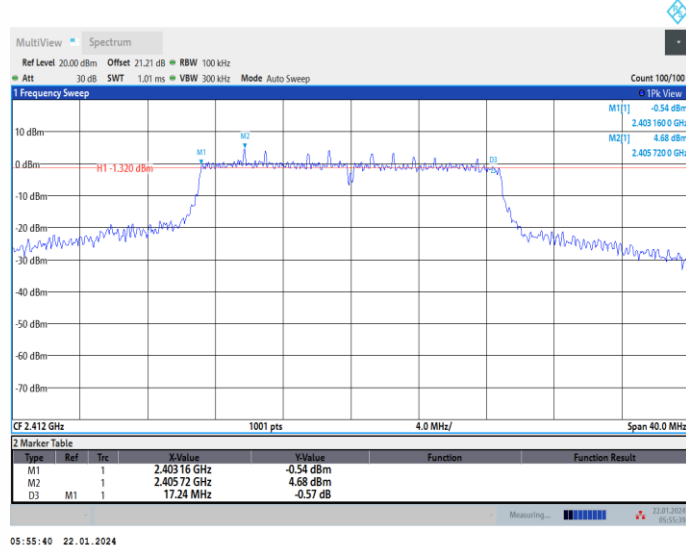

11N20SISO_Ant1_2437

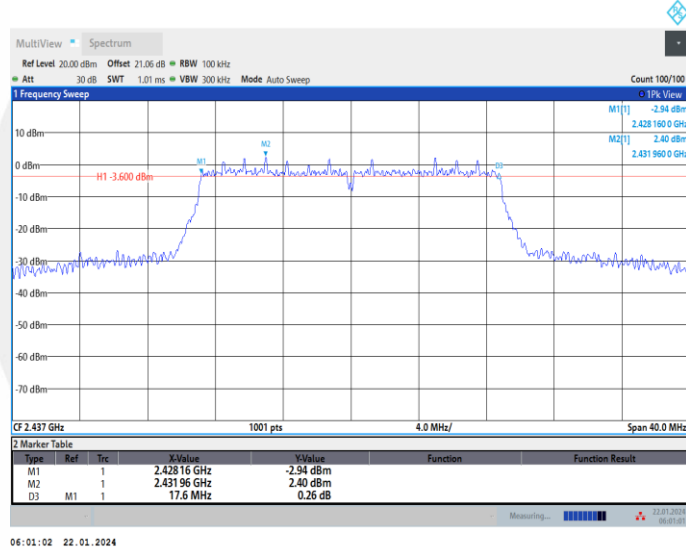

11N20SISO_Ant1_2462

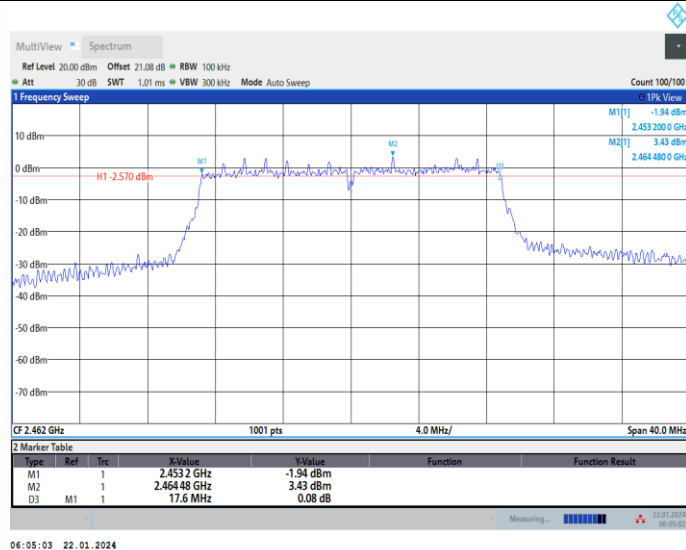

11B_Ant1_2412

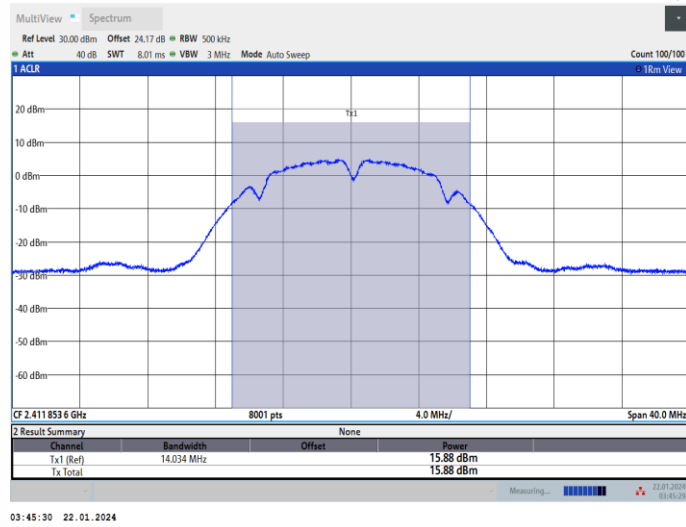

11B_Ant1_2437

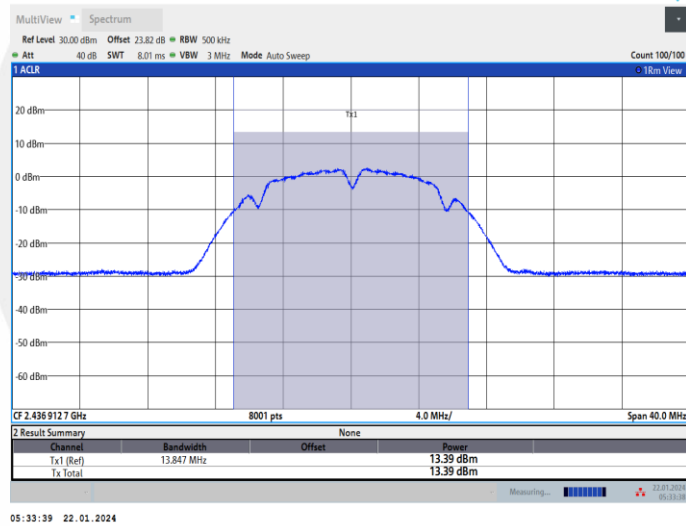

11B_Ant1_2462

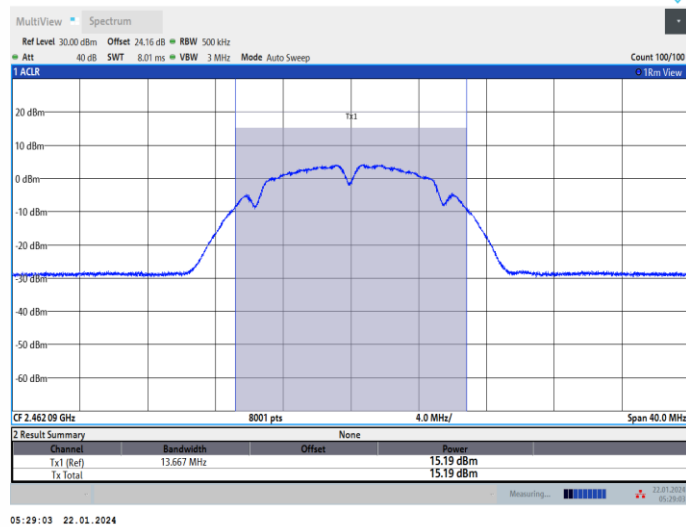

11G_Ant1_2412

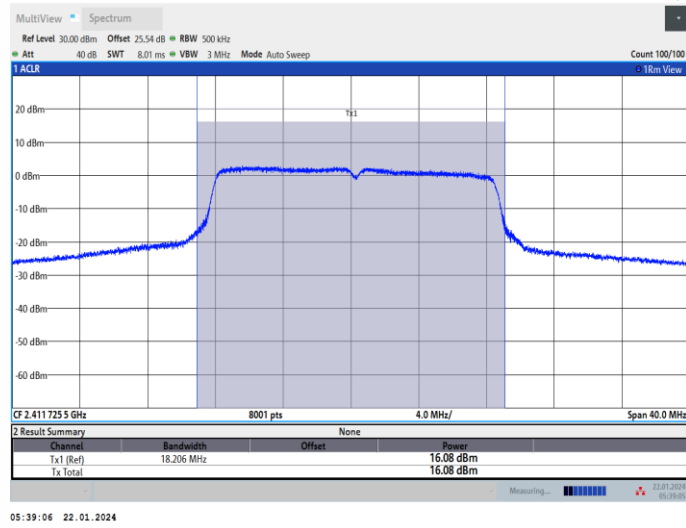

11G_Ant1_2437

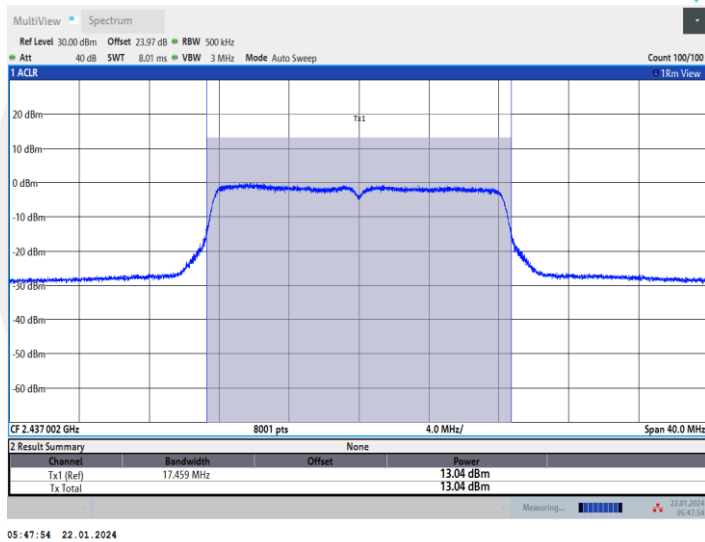

11G_Ant1_2462

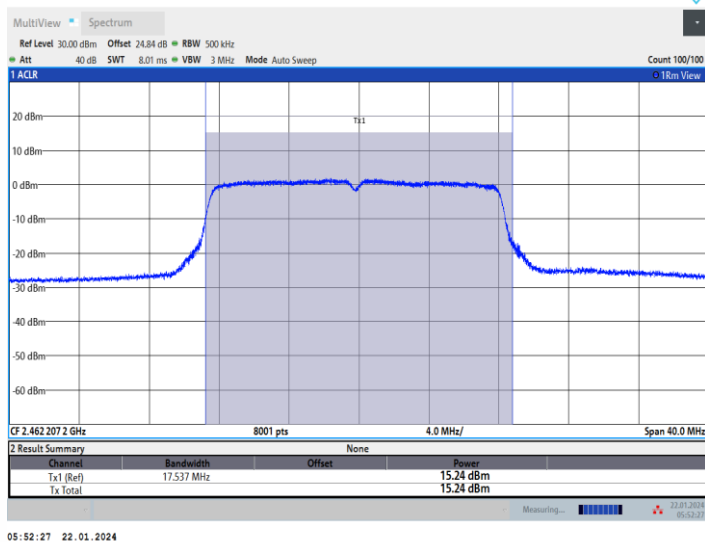

11N20SISO_Ant1_2412

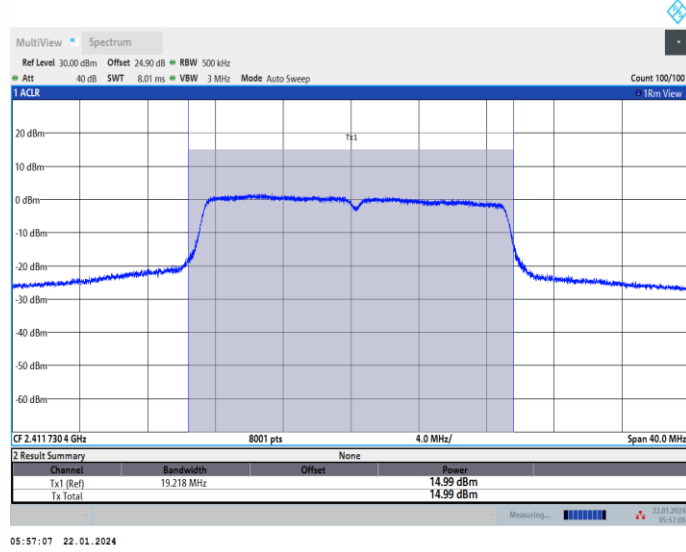

11N20SISO_Ant1_2437

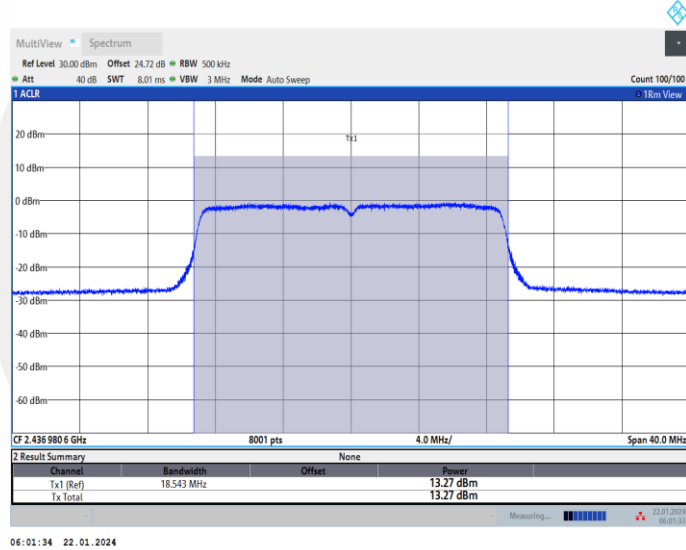

11N20SISO_Ant1_2462

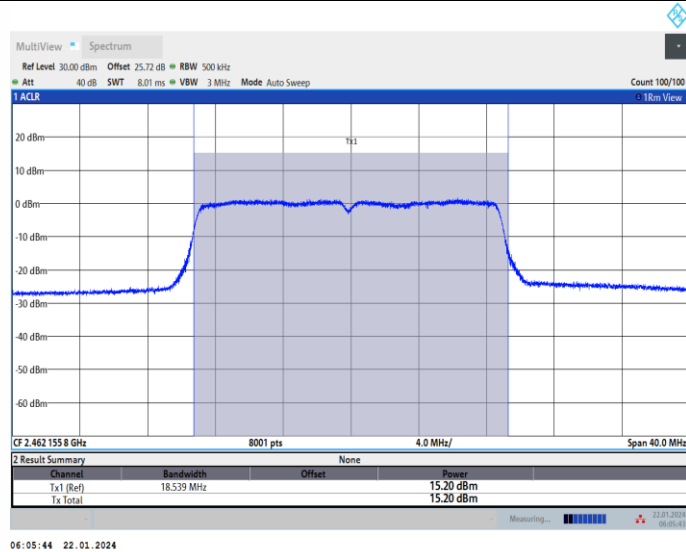

11B_Ant1_2412

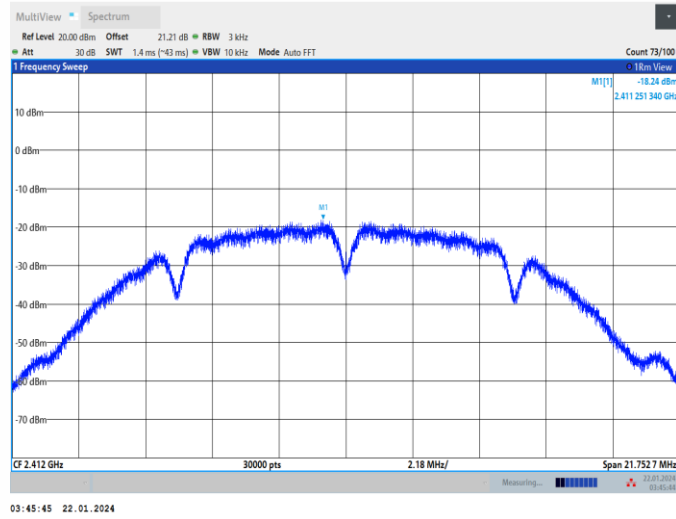

11B_Ant1_2437

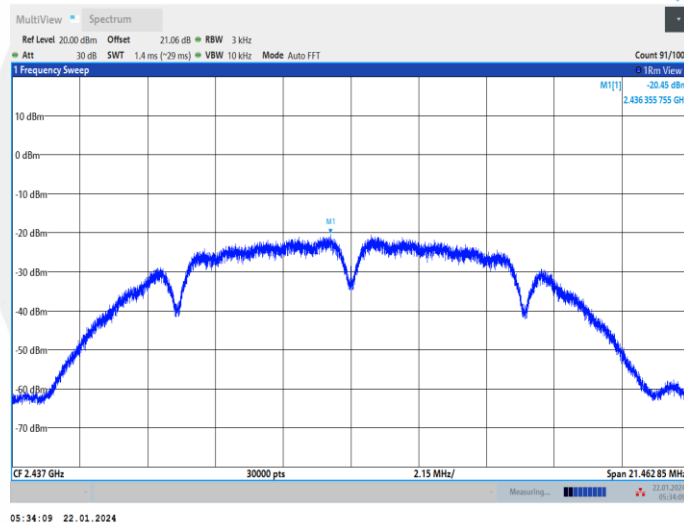

11B_Ant1_2462

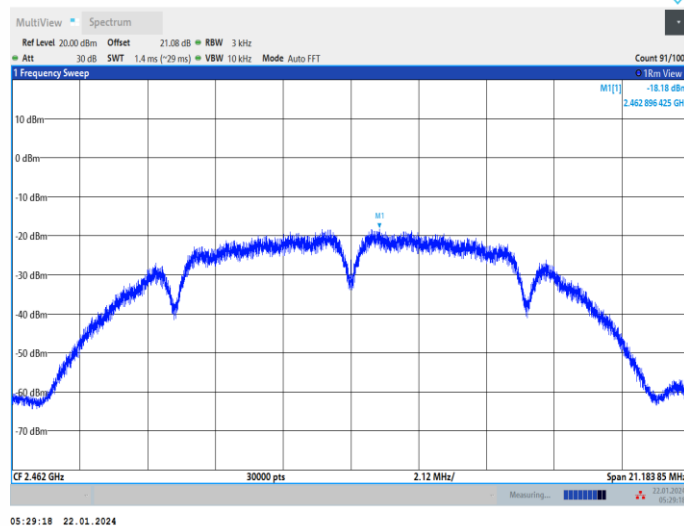

11G_Ant1_2412

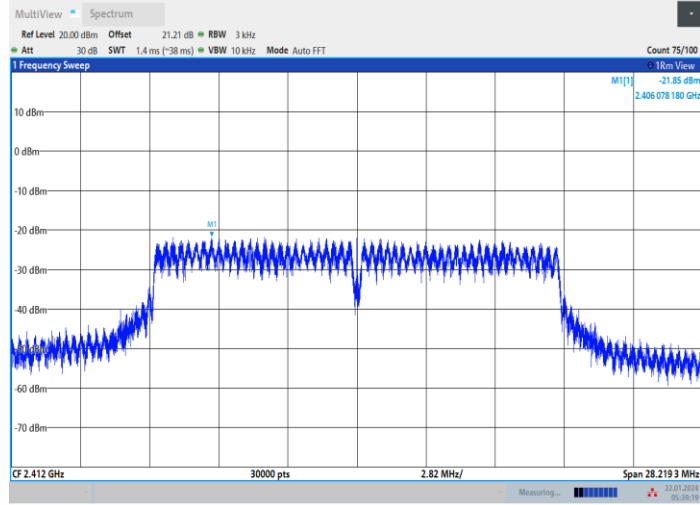

05:39:19 22.01.2024

11G_Ant1_2437

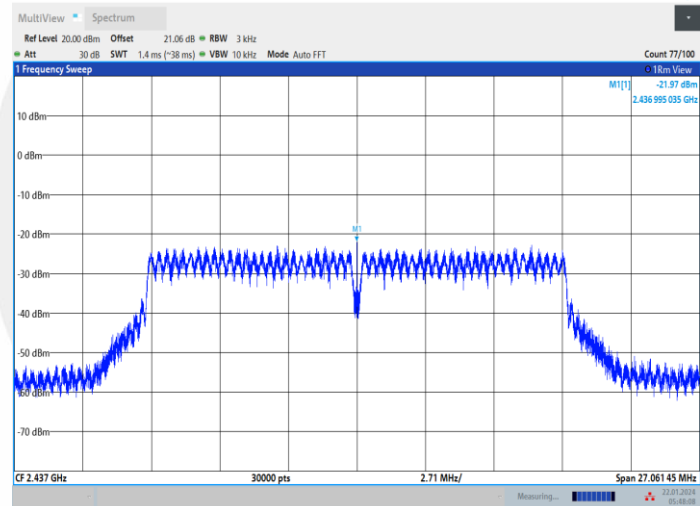

05:48:08 22.01.2024

11G_Ant1_2462

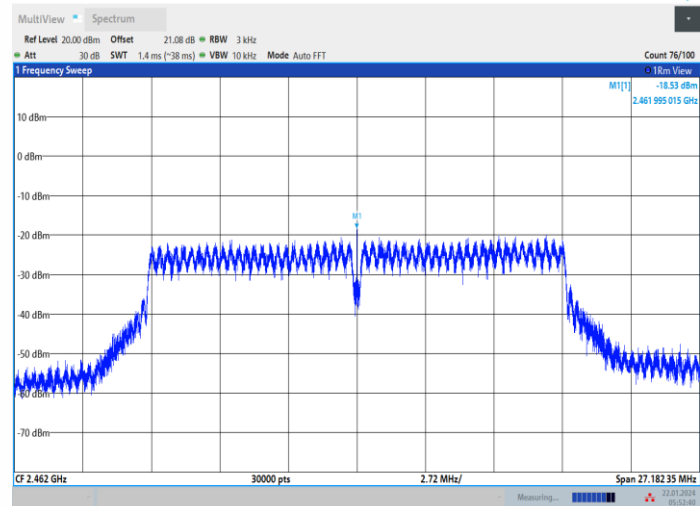

05:52:40 22.01.2024

11N20SISO_Ant1_2412

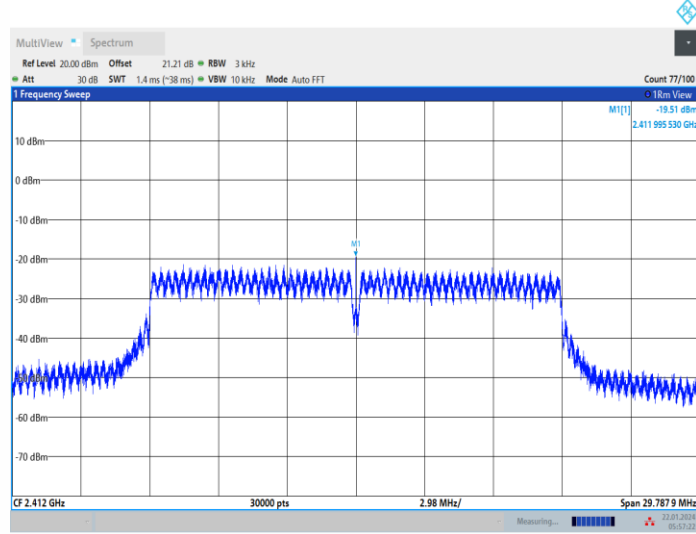

05:57:22 22.01.2024

11N20SISO_Ant1_2437

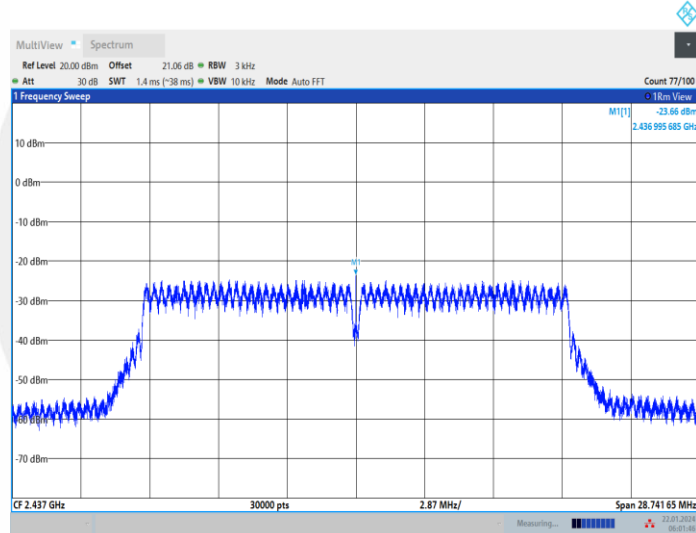

06:01:47 22.01.2024

11N20SISO_Ant1_2462

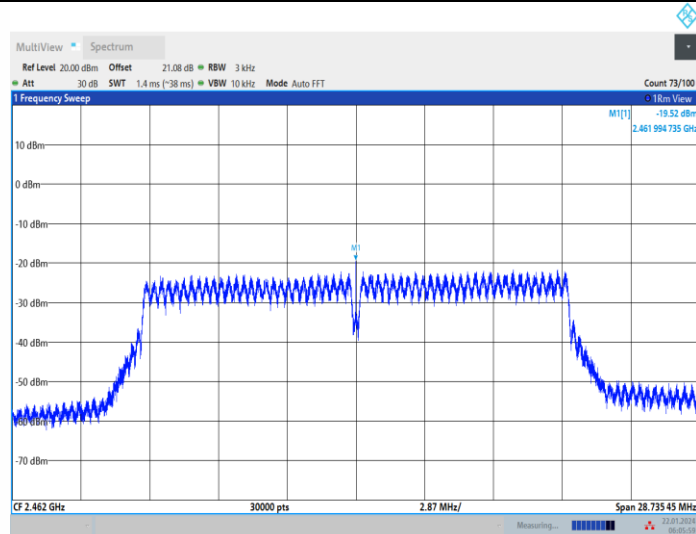

06:05:59 22.01.2024

7.4 UNWANTED SPURIOUS EMISSIONS

7.4.1 Applicable Standard

According to FCC Part15.247(d) and KDB 558074 D01 15.247 Meas Guidance v05r02

7.4.2 Conformance Limit

According to FCC Part 15.247(d):

In any 100 kHz bandwidth outside the frequency band in which the spread spectrum or digitally modulated device is operating, the RF power that is produced shall be at least 20 dB below that in the 100 kHz bandwidth within the band that contains the highest level of the desired power, based on either an RF conducted or a radiated measurement, provided that the transmitter demonstrates compliance with the peak conducted power limits. If the transmitter complies with the conducted power limits based on the use of root-mean-square averaging over a time interval, as permitted under section 5.4(d), the attenuation required shall be 30 dB instead of 20 dB. Attenuation below the general field strength limits specified in RSS-Gen is not required.

7.4.3 Test Configuration

Test according to clause 6.1 radio frequency test setup

7.4.4 Test Procedure

The transmitter output (antenna port) was connected to the spectrum analyzer

■ Reference level measurement

Establish a reference level by using the following procedure:

Set instrument center frequency to DTS channel center frequency.

Set the span to ≥ 1.5 times the DTS bandwidth.

Set the RBW = 100 kHz.

Set the VBW $\geq 3 \times$ RBW.

Set Detector = peak.

Set Sweep time = auto couple.

Set Trace mode = max hold.

Allow trace to fully stabilize.

Use the peak marker function to determine the maximum PSD level.

Note that the channel found to contain the maximum PSD level can be used to establish the reference level.

■ Emission level measurement

Set the center frequency and span to encompass frequency range to be measured.

Set the RBW = 100 kHz.

Set the VBW = 300 kHz.

Set Detector = peak

Sweep time = auto couple.

Trace mode = max hold.

Allow trace to fully stabilize.

Use the peak marker function to determine the maximum amplitude level.

Ensure that the amplitude of all unwanted emissions outside of the authorized frequency band (excluding restricted frequency bands) are attenuated by at least the minimum requirements. Report the three highest emissions relative to the limit.

7.4.5 Test Results

All modes 2.4G 802.11b/g/n have been tested, and the worst result recorded was report as below:

Band edge measurements

TestMode	Antenna	ChName	Frequency[MHz]	RefLevel[dBm]	Result[dBm]	Limit[dBm]	Verdict
11B	Ant1	Low	2412	6.45	-28.19	≤-13.55	PASS
		High	2462	6.07	-36.84	≤-13.93	PASS
11G	Ant1	Low	2412	4.62	-18.54	≤-15.38	PASS
		High	2462	3.97	-29.84	≤-16.03	PASS
11N20SISO	Ant1	Low	2412	4.56	-18.23	≤-15.44	PASS
		High	2462	3.45	-28.54	≤-16.55	PASS

Conducted Spurious Emission

TestMode	Antenna	Frequency[MHz]	FreqRange [Mhz]	RefLevel [dBm]	Result [dBm]	Limit [dBm]	Verdict
11B	Ant1	2412	Reference	6.58	6.58	---	PASS
			30~1000	6.58	-44.8	≤-23.42	PASS
			1000~26500	6.58	-40.43	≤-23.42	PASS
		2437	Reference	4.61	4.61	---	PASS
			30~1000	4.61	-43.92	≤-25.39	PASS
			1000~26500	4.61	-40.59	≤-25.39	PASS
		2462	Reference	5.82	5.82	---	PASS
			30~1000	5.82	-44.4	≤-24.18	PASS
			1000~26500	5.82	-40.39	≤-24.18	PASS
11G	Ant1	2412	Reference	4.53	4.53	---	PASS
			30~1000	4.53	-43.5	≤-25.47	PASS
			1000~26500	4.53	-41	≤-25.47	PASS
		2437	Reference	2.89	2.89	---	PASS
			30~1000	2.89	-43.61	≤-27.11	PASS
			1000~26500	2.89	-41.21	≤-27.11	PASS
		2462	Reference	4.09	4.09	---	PASS
			30~1000	4.09	-43.52	≤-25.91	PASS
			1000~26500	4.09	-40.61	≤-25.91	PASS
11N20SISO	Ant1	2412	Reference	4.54	4.54	---	PASS
			30~1000	4.54	-42.39	≤-25.46	PASS
			1000~26500	4.54	-40.41	≤-25.46	PASS
		2437	Reference	2.38	2.38	---	PASS
			30~1000	2.38	-44.48	≤-27.62	PASS
			1000~26500	2.38	-40.75	≤-27.62	PASS
		2462	Reference	3.79	3.79	---	PASS
			30~1000	3.79	-44	≤-26.21	PASS
			1000~26500	3.79	-40.84	≤-26.21	PASS

Band edge measurements

11B_Ant1_Low_2412

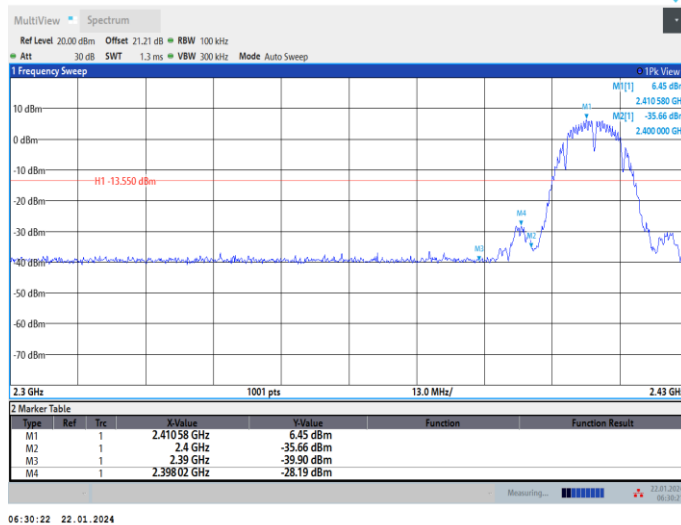

06:30:22 22.01.2024

11B_Ant1_High_2462

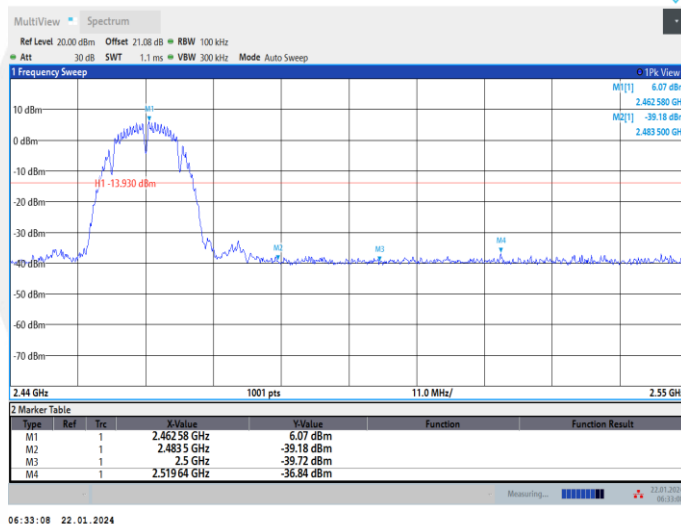

06:33:08 22.01.2024

11G_Ant1_Low_2412

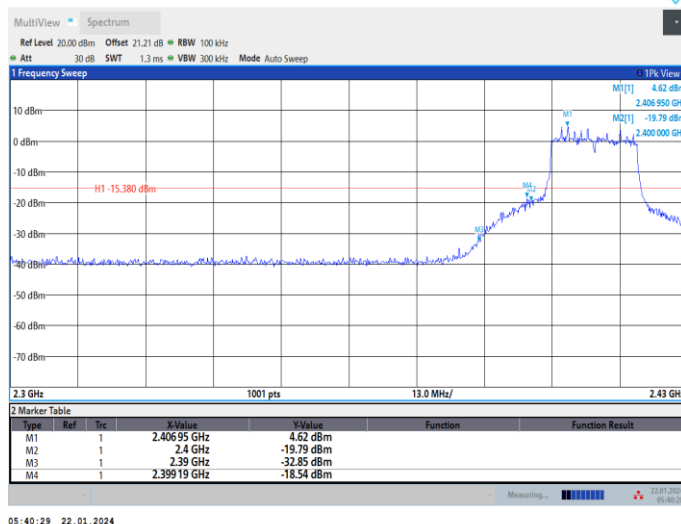

05:40:29 22.01.2024

11G_Ant1_High_2462

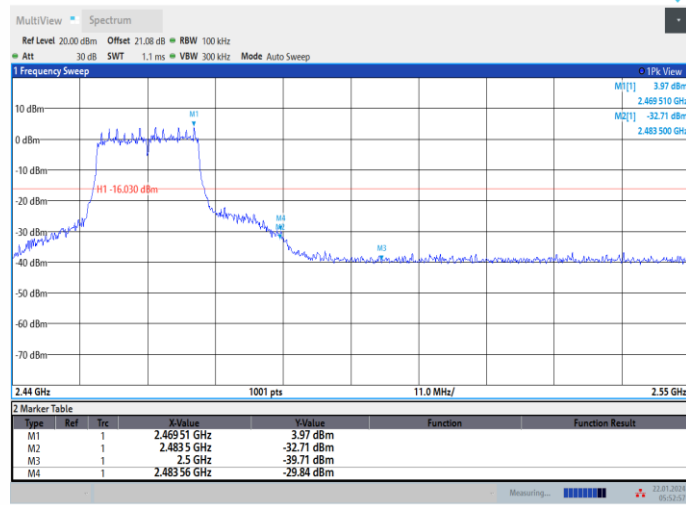

05:52:57 22.01.2024

11N20SISO_Ant1_Low_2412

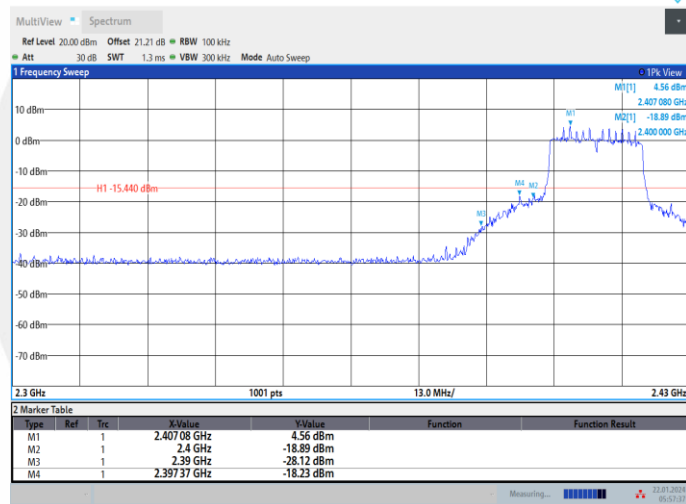

05:57:37 22.01.2024

11N20SISO_Ant1_High_2462

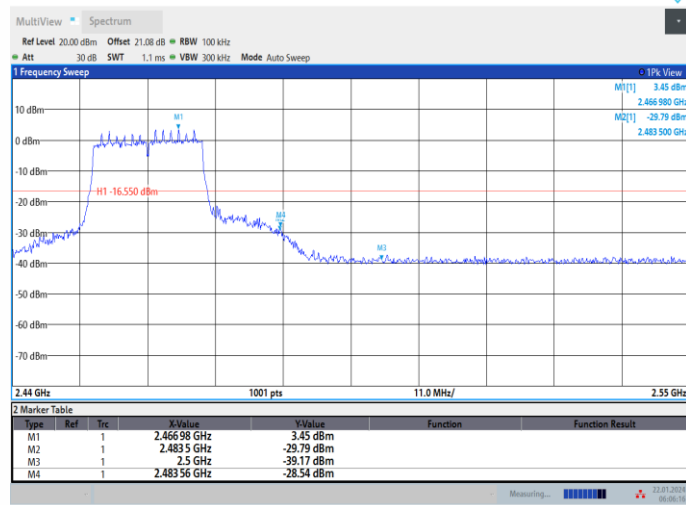

06:06:16 22.01.2024

Conducted Spurious Emission

11B_Ant1_2412_0~Reference

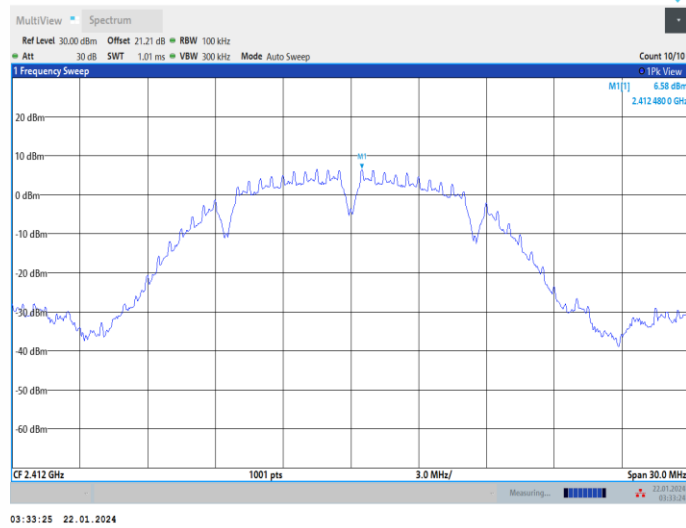

11B_Ant1_2412_30~1000

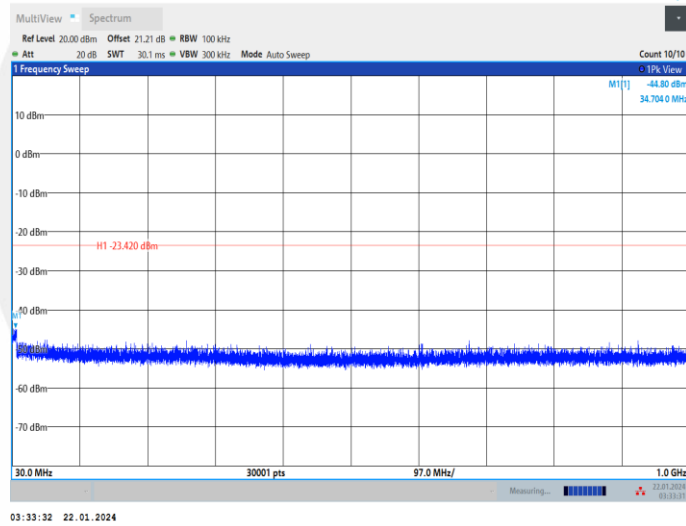

11B_Ant1_2412_1000~26500

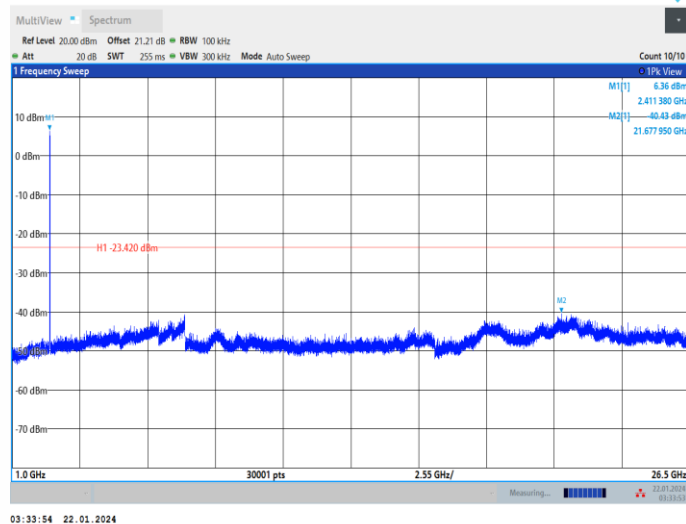

11B_Ant1_2437_0~Reference

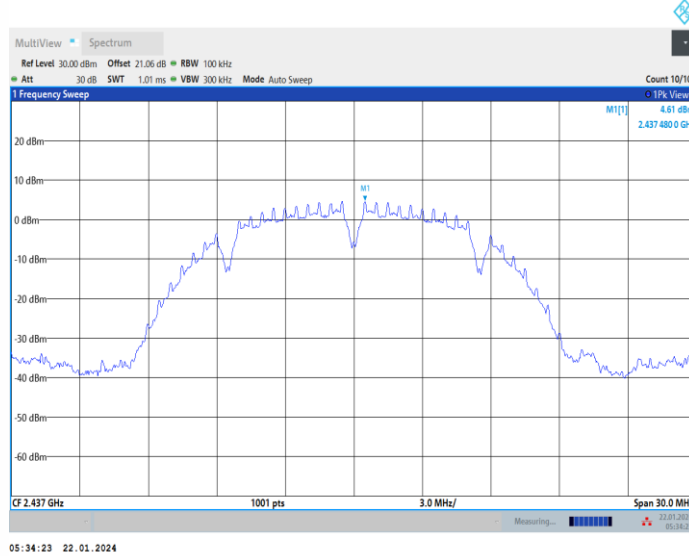

11B_Ant1_2437_30~1000

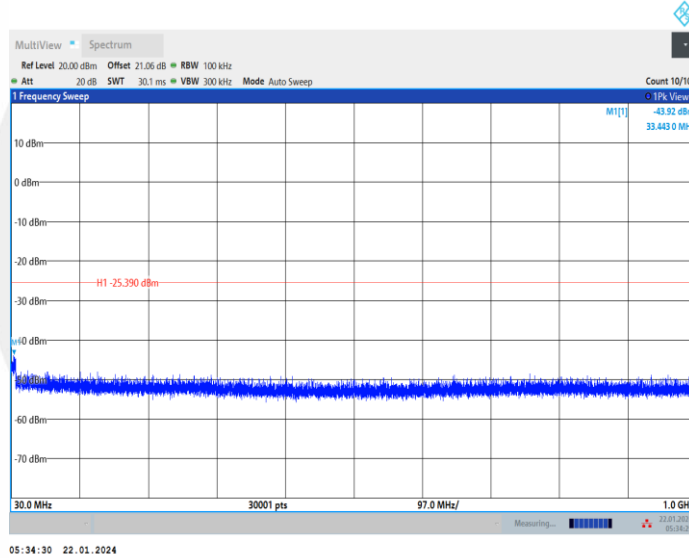

11B_Ant1_2437_1000~26500

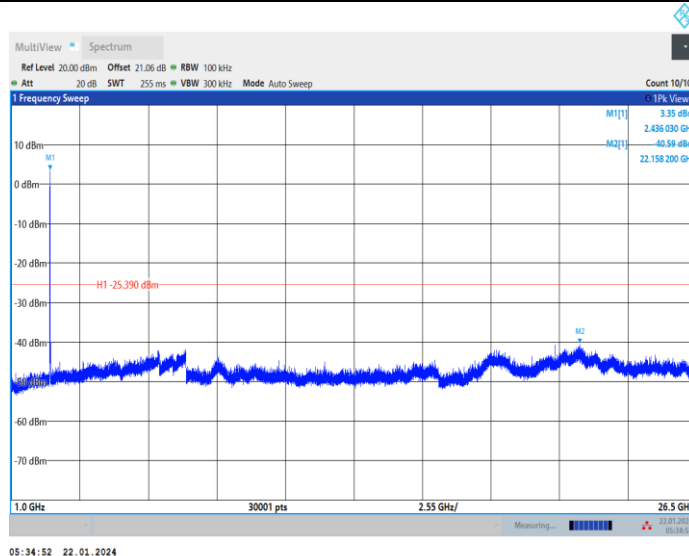

11B_Ant1_2462_0~Reference

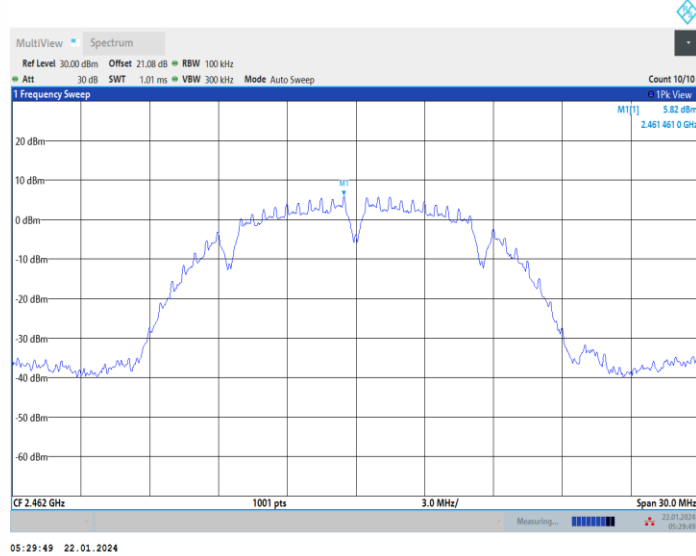

11B_Ant1_2462_30~1000

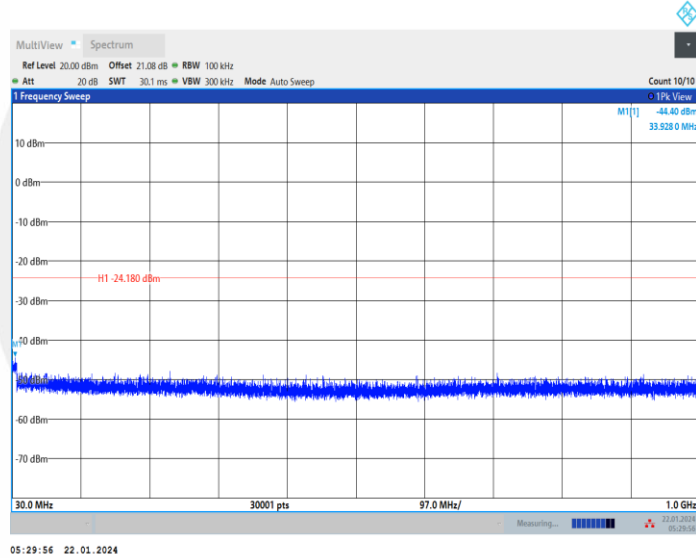

11B_Ant1_2462_1000~26500

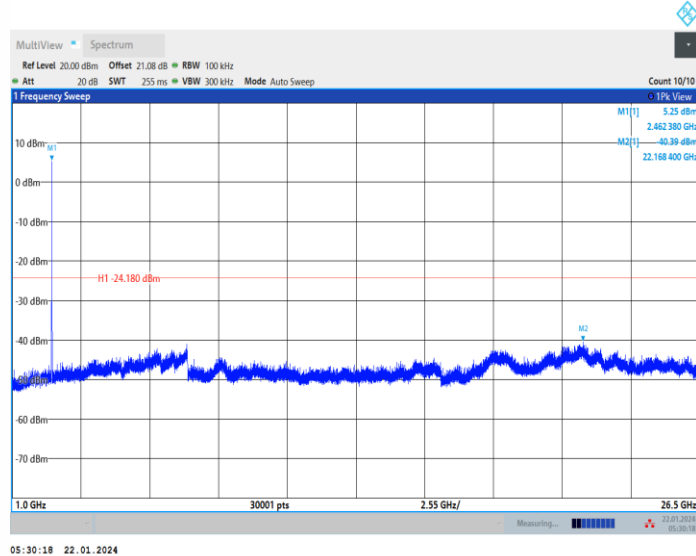

11G_Ant1_2412_0-Reference

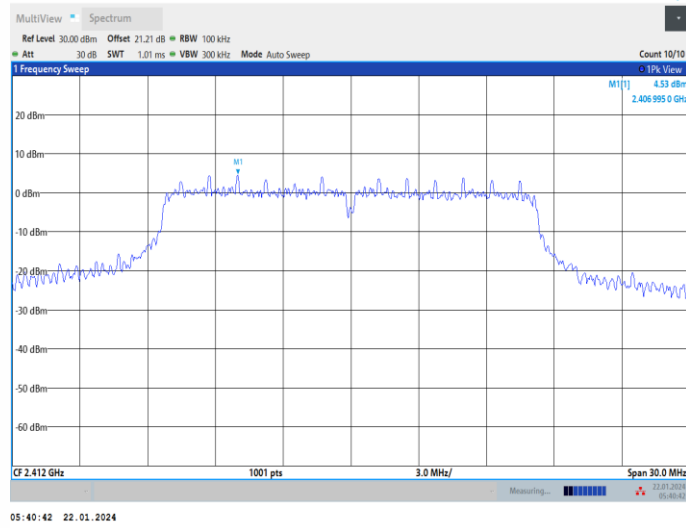

11G_Ant1_2412_30-1000

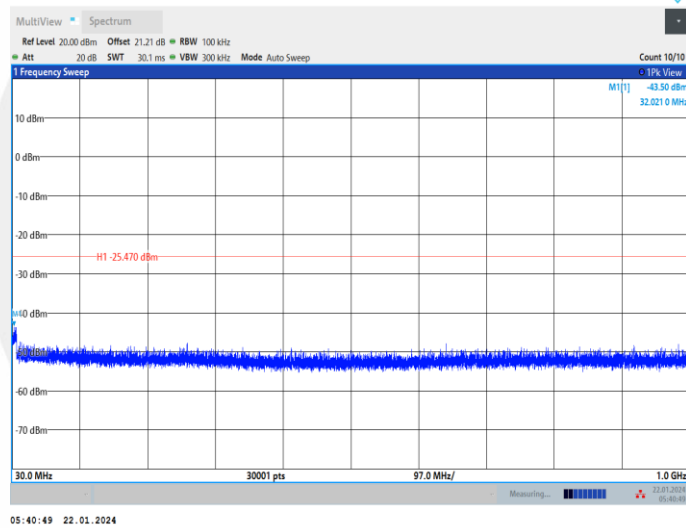

11G_Ant1_2412_1000-26500

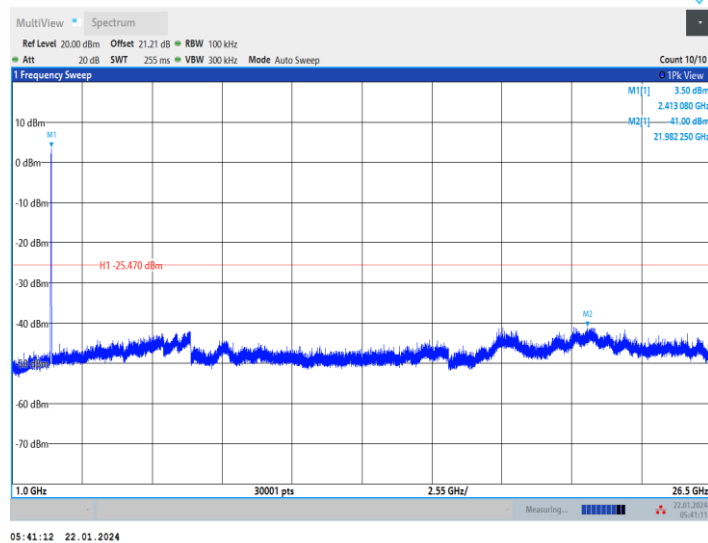

11G_Ant1_2437_0-Reference

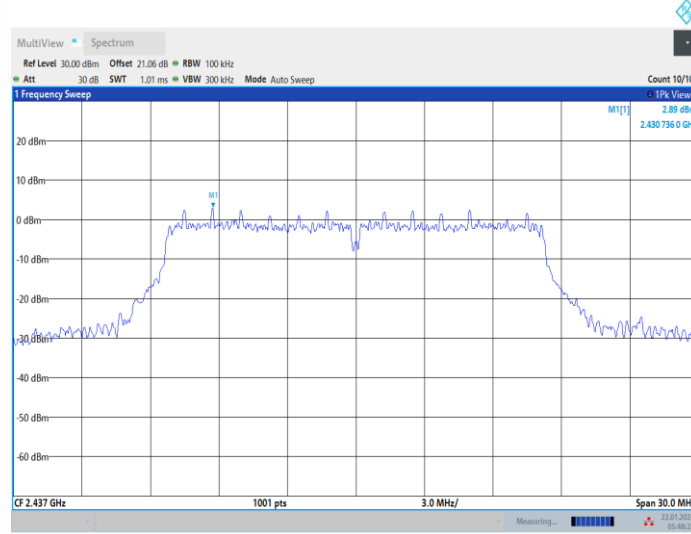

05:48:23 22.01.2024

11G_Ant1_2437_30~1000

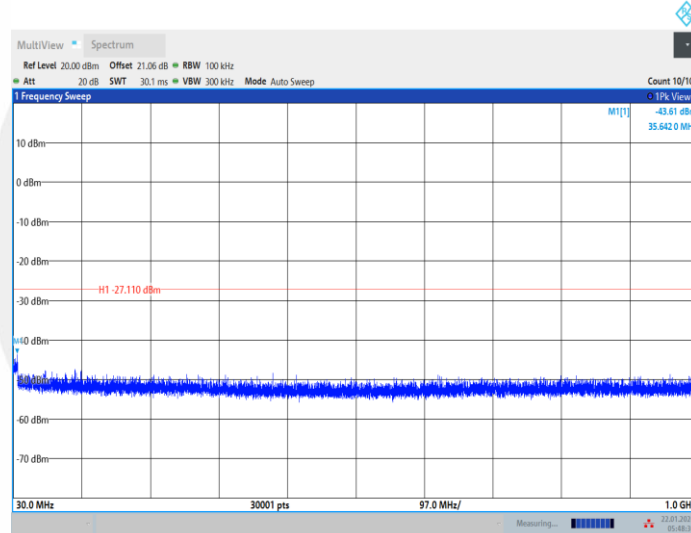

05:48:30 22.01.2024

11G_Ant1_2437_1000~26500

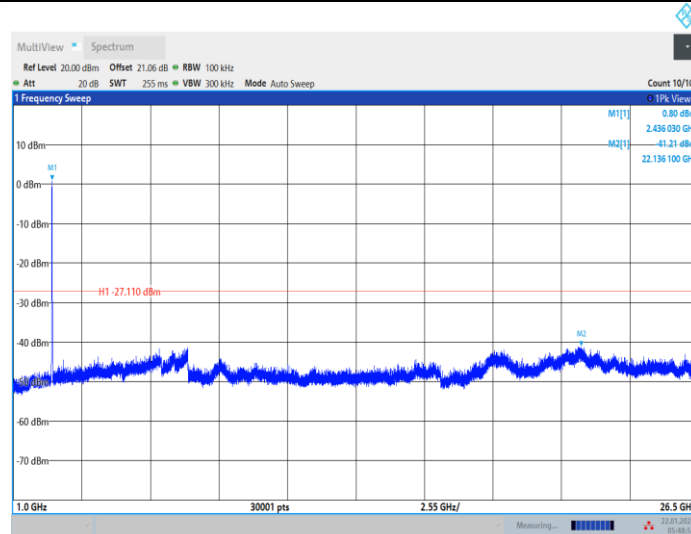

05:48:52 22.01.2024

11G_Ant1_2462_0-Reference

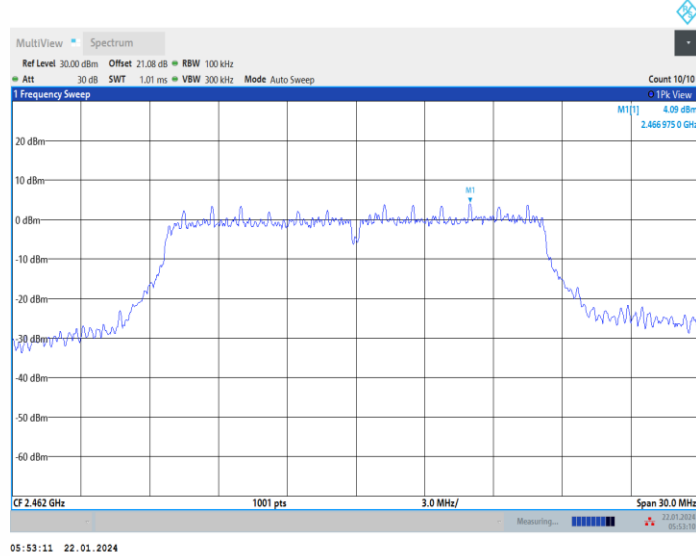

11G_Ant1_2462_30~1000

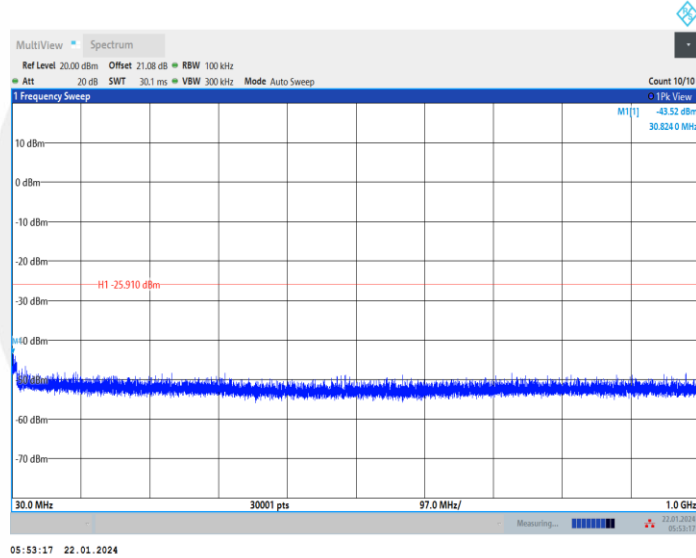

11G_Ant1_2462_1000~26500

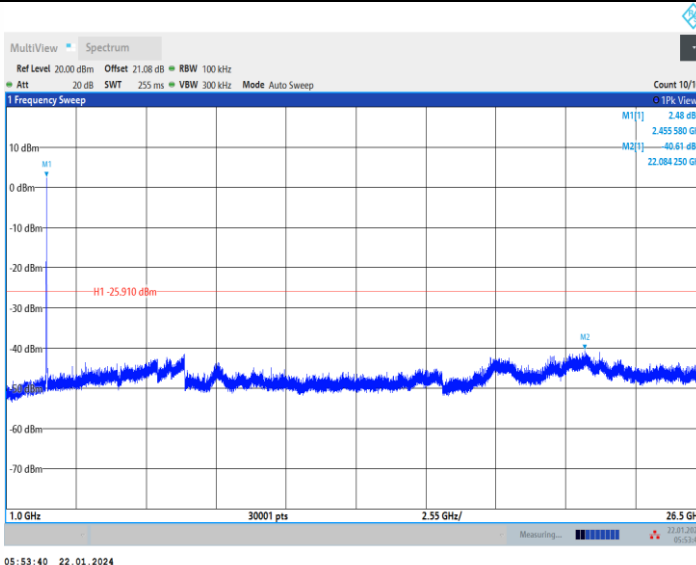

11N20SISO_Ant1_2412_0~Reference

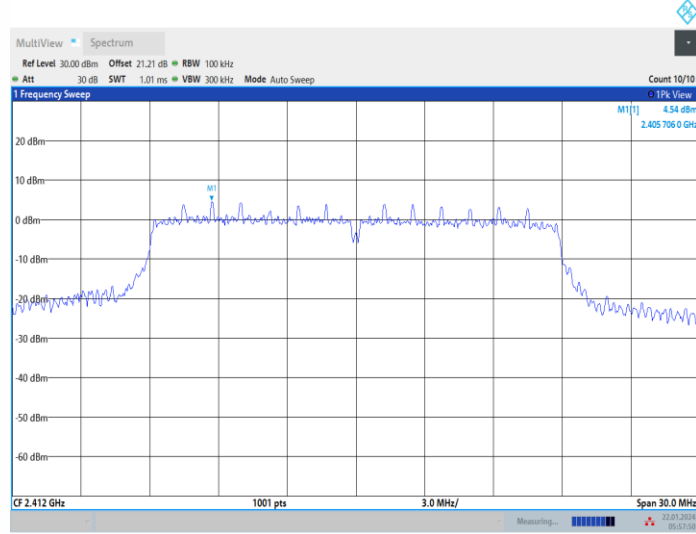

11N20SISO_Ant1_2412_30~1000

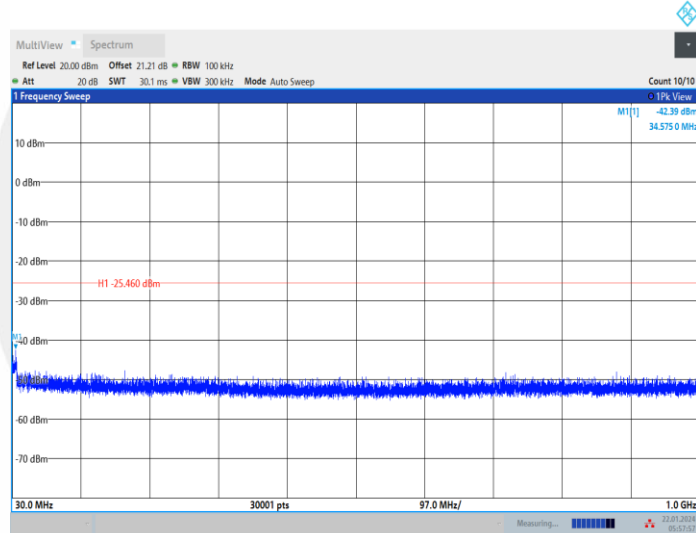

11N20SISO_Ant1_2412_1000~26500

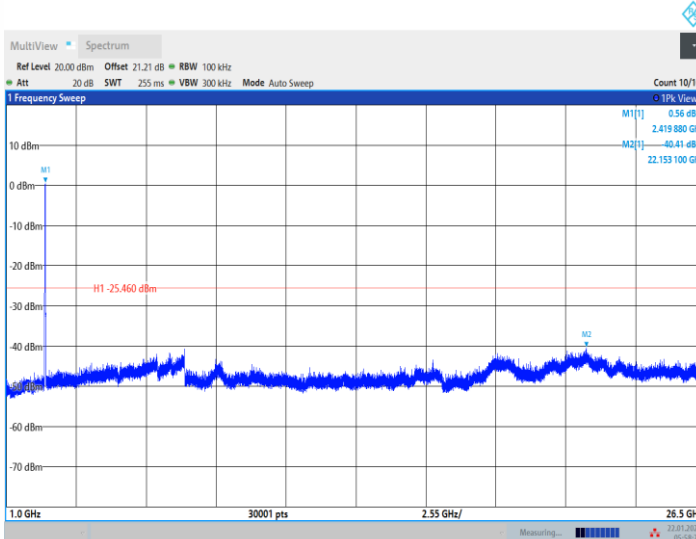

11N20SISO_Ant1_2437_0~Reference

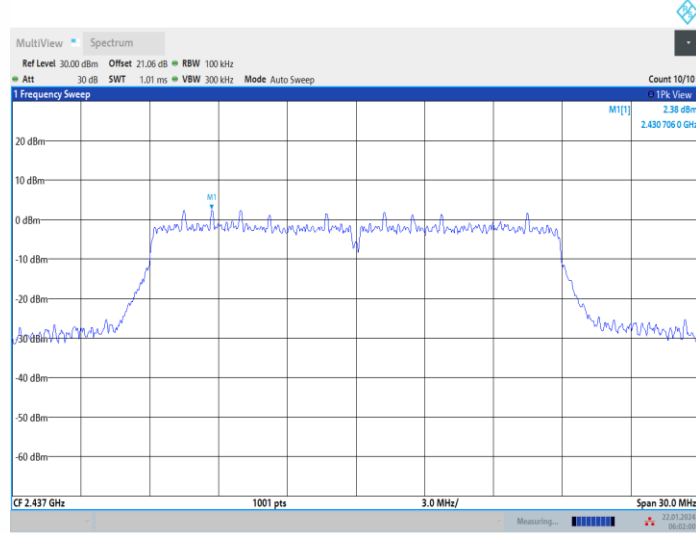

11N20SISO_Ant1_2437_30~1000

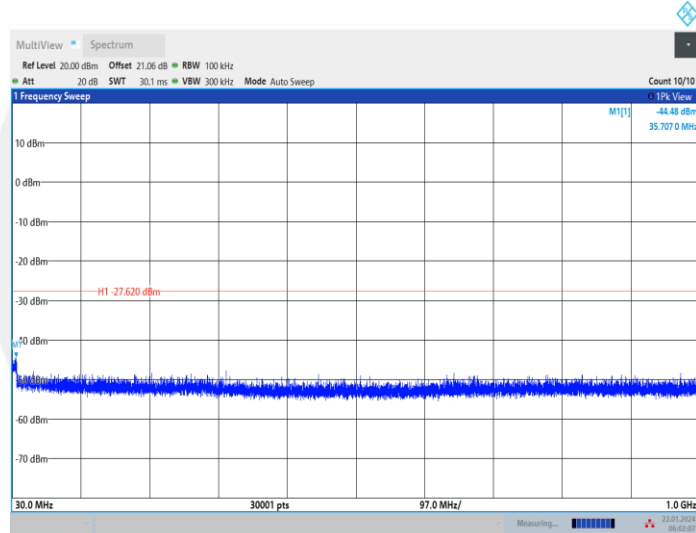

11N20SISO_Ant1_2437_1000~26500

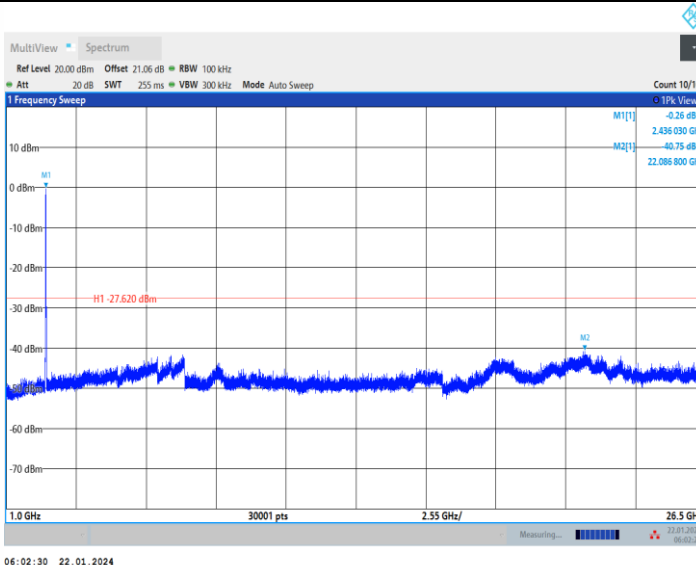

11N20SISO_Ant1_2462_0~Reference

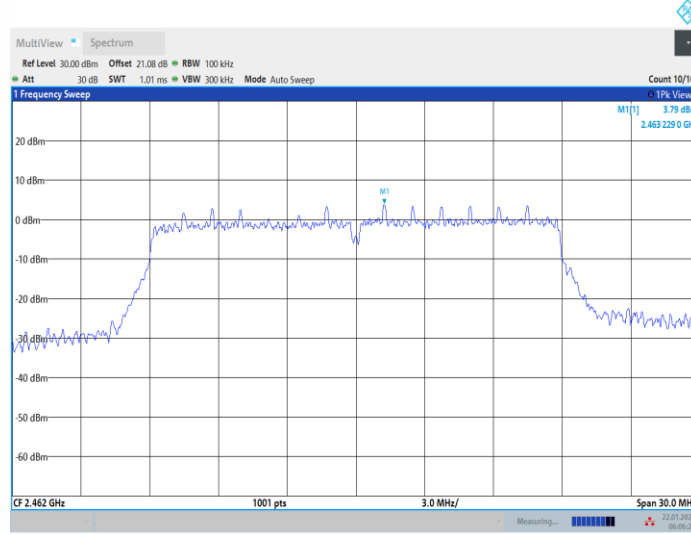

11N20SISO_Ant1_2462_30~1000

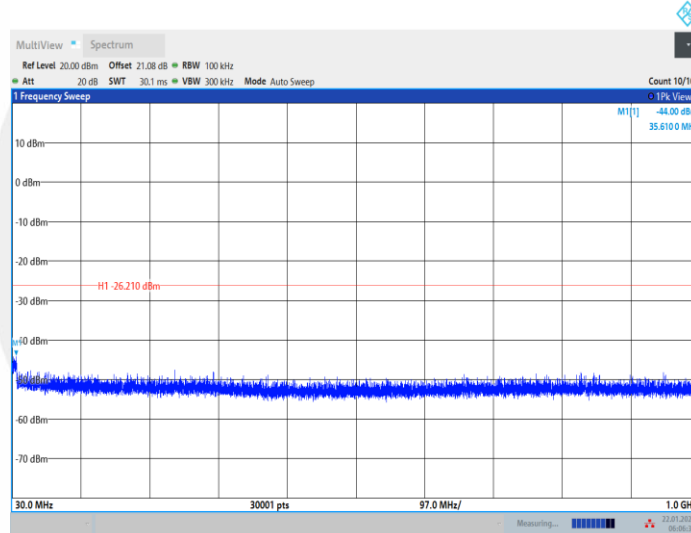

11N20SISO_Ant1_2462_1000~26500

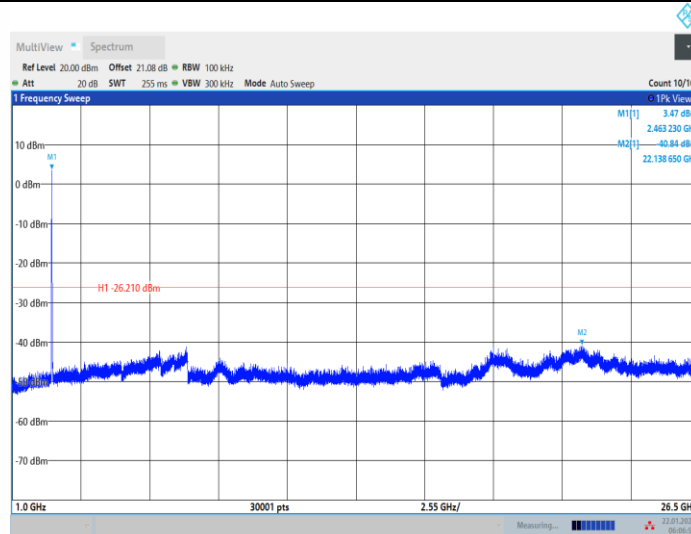

7.5 RADIATED EMISSION

7.5.1 Applicable Standard

According to FCC Part 15.247(d) and 15.209 and KDB 558074 D01 15.247 Meas Guidance v05r02

7.5.2 Conformance Limit

According to FCC Part 15.247(d): radiated emissions which fall in the restricted bands, as defined in §15.205(a), must also comply with the radiated emission limits specified in §15.209(a) (see §15.205(c)).

According to FCC Part 15.205, Restricted bands

MHz	MHz	MHz	GHz
0.090-0.110	16.42-16.423	399.9-410	4.5-5.15
10.495-0.505	16.69475-16.69525	608-614	5.35-5.46
2.1735-2.1905	16.80425-16.80475	960-1240	7.25-7.75
4.125-4.128	25.5-25.67	1300-1427	8.025-8.5
4.17725-4.17775	37.5-38.25	1435-1626.5	9.0-9.2
4.20725-4.20775	73-74.6	1645.5-1646.5	9.3-9.5
6.215-6.218	74.8-75.2	1660-1710	10.6-12.7
6.26775-6.26825	123-138	2200-2300	14.47-14.5
8.291-8.294	149.9-150.05	2310-2390	15.35-16.2
8.362-8.366	156.52475-156.52525	2483.5-2500	17.7-21.4
8.37625-8.38675	156.7-156.9	2690-2900	22.01-23.12
8.41425-8.41475	162.0125-167.17	3260-3267	23.6-24.0
12.29-12.293	167.72-173.2	3332-3339	31.2-31.8
12.51975-12.52025	240-285	3345.8-3358	36.43-36.5
12.57675-12.57725	322-335.4	3600-4400	(2)
13.36-13.41			

According to FCC Part 15.205 the level of any transmitter spurious emission in Restricted bands shall not exceed the level of the emission specified in the following table

Restricted Frequency(MHz)	Field Strength (µV/m)	Field Strength (dBµV/m)	Measurement Distance
0.009-0.490	2400/F(KHz)	20 log (uV/m)	300
0.490-1.705	24000/F(KHz)	20 log (uV/m)	30
1.705-30	30	29.5	30
30-88	100	40	3
88-216	150	43.5	3
216-960	200	46	3
Above 960	500	54	3

7.5.3 Test Configuration

Test according to clause 6.2 radio frequency test setup

7.5.4 Test Procedure

This test is required for any spurious emission that falls in a Restricted Band, as defined in Section 15.205. It must be performed with the highest gain of each type of antenna proposed for use with the EUT. Use the following spectrum analyzer settings:

For Above 1GHz:

The EUT was placed on a turn table which is 1.5m above ground plane.

Maximum procedure was performed on the highest emissions to ensure EUT compliance.

Span = wide enough to fully capture the emission being measured

RBW = 1 MHz

VBW ≥ RBW

Sweep = auto

Detector function = peak

Trace = max hold

For Below 1GHz:

The EUT was placed on a turn table which is 0.8m above ground plane.
 Maximum procedure was performed on the highest emissions to ensure EUT compliance.
 Span = wide enough to fully capture the emission being measured
 RBW = 100 kHz for
 VBW ≥ RBW
 Sweep = auto
 Detector function = peak
 Trace = max hold

For Below 30MHz:
 The EUT was placed on a turn table which is 0.8m above ground plane.
 Maximum procedure was performed on the highest emissions to ensure EUT compliance.
 Span = wide enough to fully capture the emission being measured
 RBW = 9kHz
 VBW ≥ RBW
 Sweep = auto
 Detector function = peak
 Trace = max hold

For Below 150KHz:
 The EUT was placed on a turn table which is 0.8m above ground plane.
 Maximum procedure was performed on the highest emissions to ensure EUT compliance.
 Span = wide enough to fully capture the emission being measured
 RBW = 200Hz
 VBW ≥ RBW
 Sweep = auto
 Detector function = peak
 Trace = max hold

Follow the guidelines in ANSI C63.10 with respect to maximizing the emission by rotating the EUT, measuring the emission while the EUT is situated in three orthogonal planes (if appropriate), adjusting the measurement antenna height and polarization, etc. A pre-amp and a high pass filter are required for this test, in order to provide the measuring system with sufficient sensitivity. Allow the trace to stabilize. The peak reading of the emission, after being corrected by the antenna factor, cable loss, pre-amp gain, etc., is the peak field strength, which must comply with the limit. Submit this data. Now set the VBW to 10 Hz, while maintaining all of the other instrument settings. This peak level, once corrected, must comply with the limit. If the dwell time per channel of the hopping signal is less than 100 ms, then the reading obtained with the 10 Hz VBW may be further adjusted by a “duty cycle correction factor”, derived from $20\log(\text{dwell time}/100 \text{ ms})$, in an effort to demonstrate compliance with the limit. Submit this data.
 Repeat above procedures until all frequency measured was complete.

7.5.5 Test Results

Temperature:	28.1° C
Relative Humidity:	43%
ATM Pressure:	1011 mbar

■ Spurious Emission below 30MHz(9KHz to 30MHz)

Freq. (MHz)	Ant. Pol. H/V	Emission Level(dBuV/m)		Limit 3m(dBuV/m)		Over(dB)	
		PK	AV	PK	AV	PK	AV
--	--	--	--	--	--	--	--

Note: the amplitude of spurious emission that is attenuated by more than 20dB below the permissible limit has no need to be reported.

Distance extrapolation factor = $40\log(\text{Specific distance}/ \text{test distance})$ (dB);

Limit line=Specific limits(dBuV) + distance extrapolation factor

- Spurious Emission Above 1GHz(1GHz to 25GHz)
- All antenna modes 2.4G 802.11b/g/n have been tested, and the worst result recorded was report as below:

Test mode: 802.11 b Frequency: Channel 1: 2412MHz

Freq. (MHz)	Ant.Pol.	Emission Level(dBuV/m)		Limit 3m(dBuV/m)		Margin(dB)	
	H/V	PK	AV	PK	AV	PK	AV
4822.5	V	48.64	44.89	74.00	54.00	25.36	9.11
14647.5	V	63.10	45.73	74.00	54.00	10.90	8.27
17585.6	V	69.03	47.10	74.00	54.00	4.97	6.90
4824.3	H	49.01	44.92	74.00	54.00	24.99	9.08
14638.1	H	63.87	46.47	74.00	54.00	10.13	7.53
17615.6	H	68.74	46.64	74.00	54.00	5.26	7.36

Test mode: 802.11 b Frequency: Channel 6: 2437MHz

Freq. (MHz)	Ant.Pol.	Emission Level(dBuV/m)		Limit 3m(dBuV/m)		Margin(dB)	
	H/V	PK	AV	PK	AV	PK	AV
11469.3	V	60.67	47.13	74.00	54.00	13.33	6.87
15258.7	V	63.20	42.78	74.00	54.00	10.80	11.22
17968.1	V	67.76	44.87	74.00	54.00	6.24	9.13
11521.8	H	60.57	47.25	74.00	54.00	13.43	6.75
14542.5	H	63.87	45.38	74.00	54.00	10.13	8.62
17593.1	H	68.50	47.01	74.00	54.00	5.50	6.99

Test mode: 802.11 b Frequency: Channel 11: 2462MHz

Freq. (MHz)	Ant.Pol.	Emission Level(dBuV/m)		Limit 3m(dBuV/m)		Margin(dB)	
	H/V	PK	AV	PK	AV	PK	AV
11450.6	V	60.56	46.97	74.00	54.00	13.44	7.03
14643.7	V	63.55	46.13	74.00	54.00	10.45	7.87
17973.7	V	67.87	44.62	74.00	54.00	6.13	9.38
11448.7	H	60.03	46.97	74.00	54.00	13.97	7.03
14617.5	H	63.60	46.39	74.00	54.00	10.40	7.61
17604.3	H	68.16	47.50	74.00	54.00	5.84	6.50

- Note:**
- (1) All Readings are Peak Value (VBW=3MHz) and Average Value (VBW=10Hz).
 - (2) Corrected Reading= Reading Level+Correct Factor.
 - (3) Correct Factor= Ant_F + Cab_L - Preamp
 - (4) Margin = Limit - Corrected Reading
 - (5)The reading of emissions are attenuated more than 20dB below the permissible limits or the field strength is too small to be measured.

■ Spurious Emission in Restricted Band 2310-2390MHz and 2483.5-2500MHz
 All modes 2.4G 802.11b/g/n have been tested, and the worst result recorded was report as below:

Test mode: 802.11 b Frequency: Channel 1: 2412MHz

Frequency (MHz)	Polarity	PK(dBuV/m) (VBW=3MHz)	Limit 3m (dBuV/m)	AV(dBuV/m) (VBW=10Hz)	Limit 3m (dBuV/m)
2386.45	H	53.23	74.00	44.03	54.00
2386.47	V	50.35	74.00	44.55	54.00

Test mode: 802.11 b Frequency: Channel 11: 2462MHz

Frequency (MHz)	Polarity	PK(dBuV/m) (VBW=3MHz)	Limit 3m (dBuV/m)	AV(dBuV/m) (VBW=10Hz)	Limit 3m (dBuV/m)
2484.15	H	52.62	74	44.60	54.00
2485.77	V	49.72	74	44.30	54.00

- Note:**
- (1) All Readings are Peak Value (VBW=3MHz) and Average Value (VBW=10Hz).
 - (2) Corrected Reading= Reading Level+Correct Factor.
 - (3) Correct Factor= Ant_F + Cab_L - Preamp
 - (4) Margin = Limit - Corrected Reading
 - (5)The reading of emissions are attenuated more than 20dB below the permissible limits or the field strength is too small to be measured.

Spurious Emission in Restricted Band 2310-2390MHz

Test Model 802.11b 802.11g 802.11n(HT20) 802.11n(HT40)
 Channel 1:2412MHz Channel 3: 2422MHz Polarity: H
 VBW=3MHz

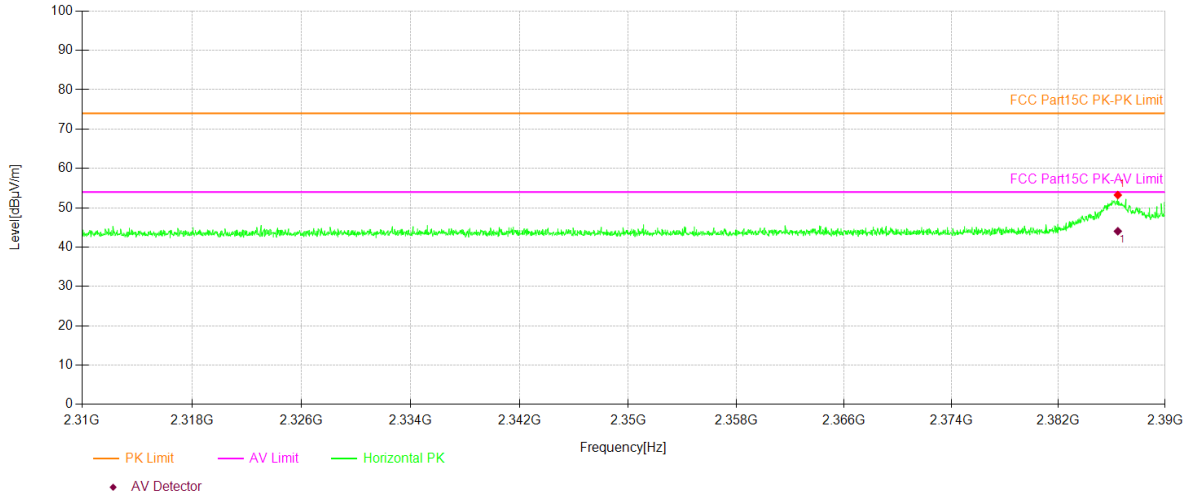

Spurious Emission in Restricted Band 2310-2390MHz

Test Model 802.11b 802.11g 802.11n(HT20) 802.11n(HT40)
 Channel 1:2412MHz Channel 3: 2422MHz Polarity: V
 VBW=3MHz

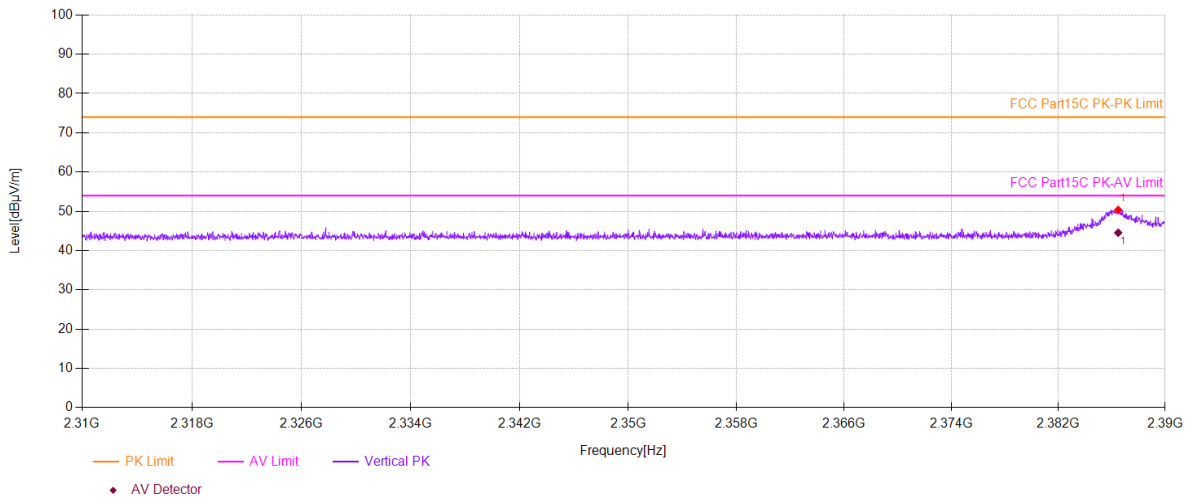

Spurious Emission in Restricted Band 2483.5-2500MHz

Test Model 802.11b 802.11g 802.11n(HT20) 802.11n(HT40)

Channel 11: 2462MHz Channel 9: 2452MHz Polarity: H

 VBW=3MHz

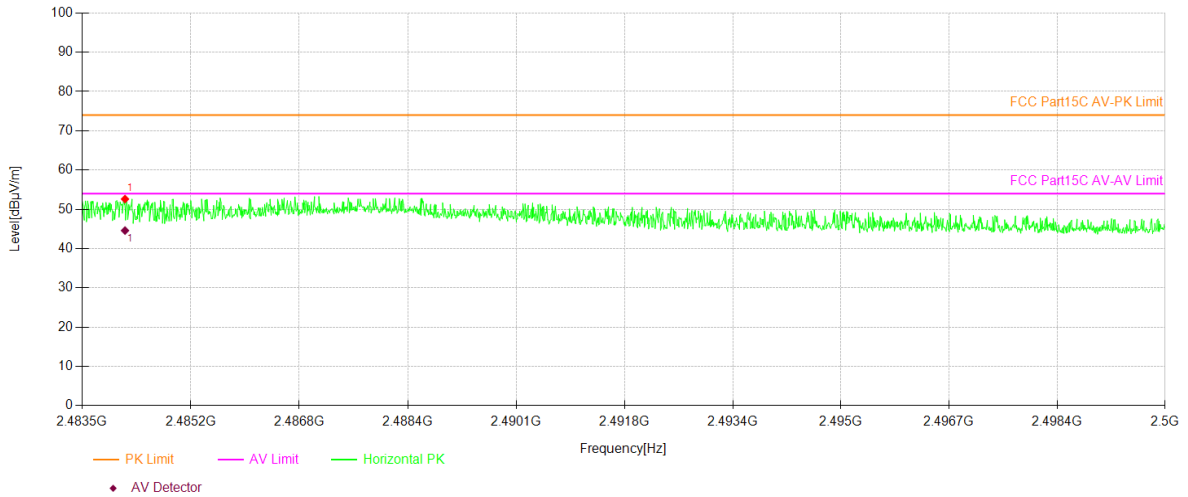

Spurious Emission in Restricted Band 2483.5-2500MHz

Test Model 802.11b 802.11g 802.11n(HT20) 802.11n(HT40)

Channel 11: 2462MHz Channel 9: 2452MHz Polarity: V

 VBW=3MHz

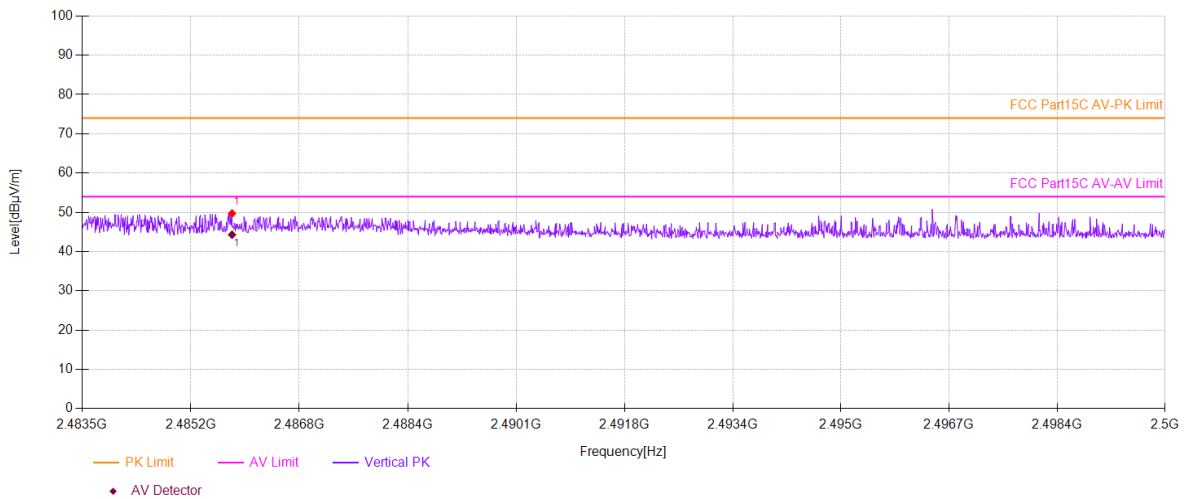

■ Spurious Emission below 1GHz (30MHz to 1GHz)

All antenna modes 2.4G 802.11b/g/n have been tested, and the worst result 802.11n20 recorded was report as below:

2412

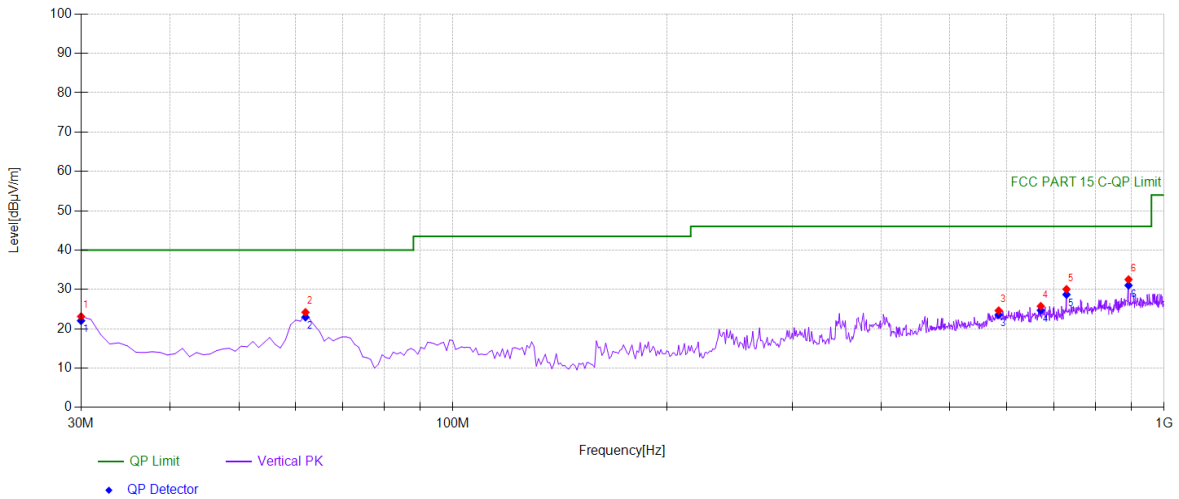

Suspected Data List								
NO.	Freq. [MHz]	Reading [dBµV]	Factor [dB/m]	Level [dBµV/m]	Detector	Limit [dBµV/m]	Margin [dB]	Polarity
1	30	41.66	-18.53	23.13	PK	40.00	16.87	Vertical
2	62.042	43.04	-18.84	24.20	PK	40.00	15.80	Vertical
3	585.395	31.76	-7.14	24.62	PK	46.00	21.38	Vertical
4	670.840	31.89	-6.14	25.75	PK	46.00	20.25	Vertical
5	729.099	35.69	-5.64	30.05	PK	46.00	15.95	Vertical
6	891.251	35.40	-2.87	32.53	PK	46.00	13.47	Vertical

Final Data List					
NO.	Freq. [MHz]	Factor [dB/m]	QP Value [dBµV/m]	QP Limit [dBµV/m]	QP Margin [dB]
1	30	-18.53	22.04	40.00	17.96
2	62.042	-18.84	22.95	40.00	17.05
3	585.3954	-7.14	23.56	46.00	22.44
4	670.8408	-6.14	24.69	46.00	21.31
5	729.0991	-5.64	28.71	46.00	17.29
6	891.2513	-2.87	31.03	46.00	14.97

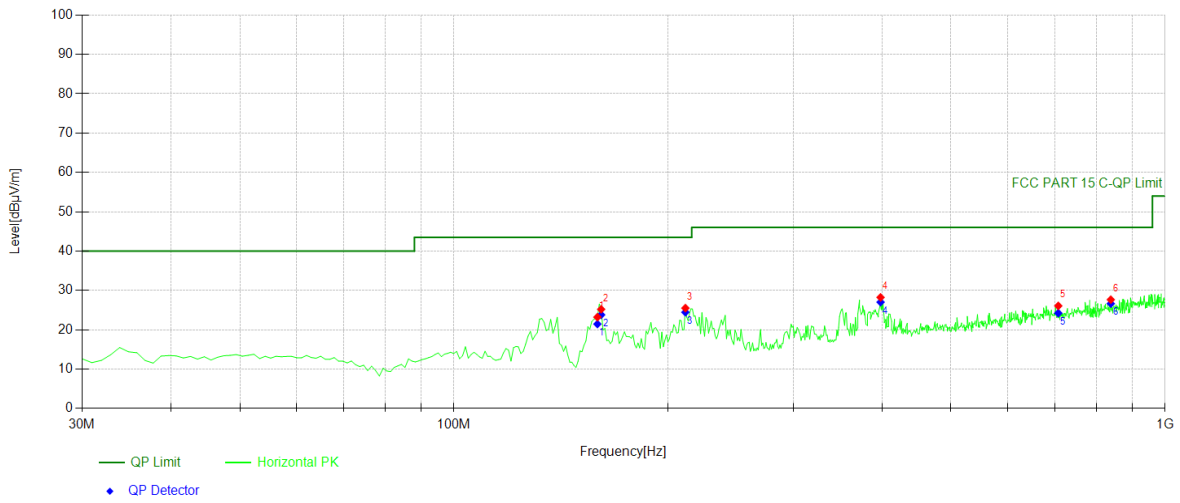

Suspected Data List								
NO.	Freq. [MHz]	Reading [dBµV]	Factor [dB/m]	Level [dBµV/m]	Detector	Limit [dBµV/m]	Margin [dB]	Polarity
1	159.139	42.84	-19.62	23.22	PK	43.50	20.28	Horizontal
2	161.081	44.74	-19.54	25.20	PK	43.50	18.30	Horizontal
3	211.571	42.64	-17.13	25.51	PK	43.50	17.99	Horizontal
4	397.998	40.04	-11.80	28.24	PK	46.00	17.76	Horizontal
5	707.737	31.94	-5.86	26.08	PK	46.00	19.92	Horizontal
6	838.818	31.55	-3.89	27.66	PK	46.00	18.34	Horizontal

Final Data List					
NO.	Freq. [MHz]	Factor [dB/m]	QP Value [dBµV/m]	QP Limit [dBµV/m]	QP Margin [dB]
1	159.1391	-19.62	21.46	43.50	22.04
2	161.0811	-19.54	23.80	43.50	19.70
3	211.5716	-17.13	24.46	43.50	19.04
4	397.998	-11.80	27.03	46.00	18.97
5	707.7377	-5.86	24.23	46.00	21.77
6	838.8188	-3.89	26.65	46.00	19.35

2437

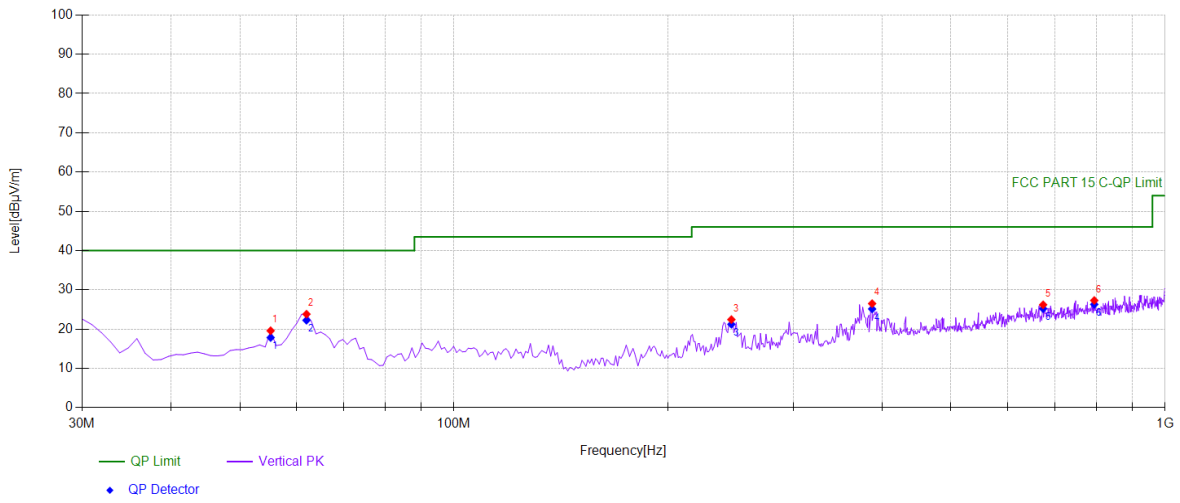

Suspected Data List								
NO.	Freq. [MHz]	Reading [dBµV]	Factor [dB/m]	Level [dBµV/m]	Detector	Limit [dBµV/m]	Margin [dB]	Polarity
1	55.2452	37.51	-17.91	19.60	PK	40.00	20.40	Vertical
2	62.042	42.66	-18.84	23.82	PK	40.00	16.18	Vertical
3	245.555	37.62	-15.18	22.44	PK	46.00	23.56	Vertical
4	387.317	38.33	-11.83	26.50	PK	46.00	19.50	Vertical
5	673.753	32.33	-6.13	26.20	PK	46.00	19.80	Vertical
6	795.125	31.77	-4.47	27.30	PK	46.00	18.70	Vertical

Final Data List					
NO.	Freq. [MHz]	Factor [dB/m]	QP Value [dBµV/m]	QP Limit [dBµV/m]	QP Margin [dB]
1	55.2452	-17.91	17.85	40.00	22.15
2	62.042	-18.84	22.26	40.00	17.74
3	245.5556	-15.18	21.24	46.00	24.76
4	387.3173	-11.83	25.14	46.00	20.86
5	673.7538	-6.13	25.20	46.00	20.80
6	795.1251	-4.47	26.30	46.00	19.70

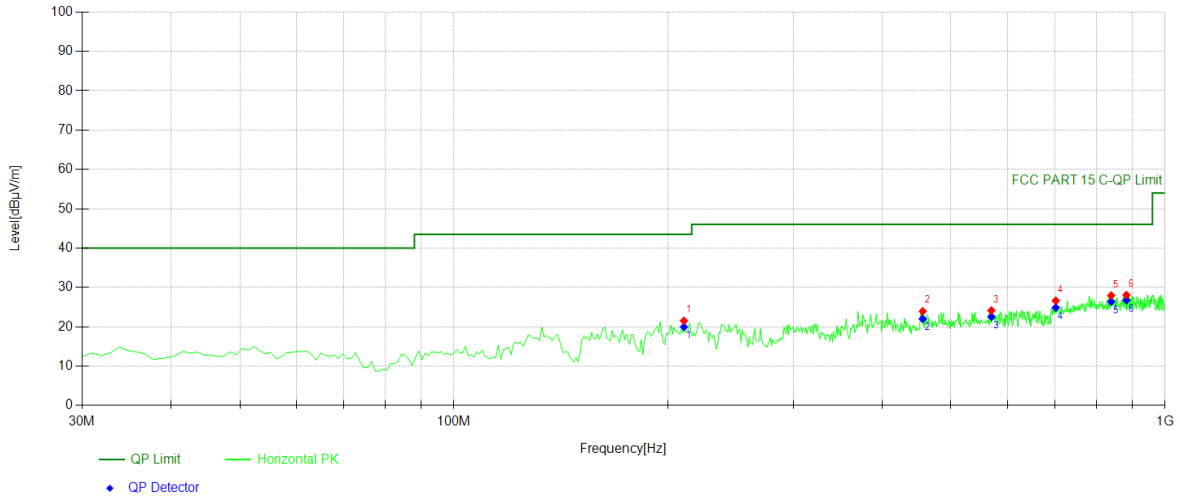

Suspected Data List								
NO.	Freq. [MHz]	Reading [dBµV]	Factor [dB/m]	Level [dBµV/m]	Detector	Limit [dBµV/m]	Margin [dB]	Polarity
1	210.600	38.65	-17.13	21.52	PK	43.50	21.98	Horizontal
2	456.256	35.03	-11.07	23.96	PK	46.00	22.04	Horizontal
3	569.859	32.21	-8.06	24.15	PK	46.00	21.85	Horizontal
4	701.911	32.55	-5.92	26.63	PK	46.00	19.37	Horizontal
5	839.789	31.81	-3.86	27.95	PK	46.00	18.05	Horizontal
6	882.512	31.03	-2.95	28.08	PK	46.00	17.92	Horizontal

Final Data List					
NO.	Freq. [MHz]	Factor [dB/m]	QP Value [dBµV/m]	QP Limit [dBµV/m]	QP Margin [dB]
1	210.6006	-17.13	19.96	43.50	23.54
2	456.2563	-11.07	22.01	46.00	23.99
3	569.8599	-8.06	22.56	46.00	23.44
4	701.9119	-5.92	24.88	46.00	21.12
5	839.7898	-3.86	26.39	46.00	19.61
6	882.5125	-2.95	26.77	46.00	19.23

2462

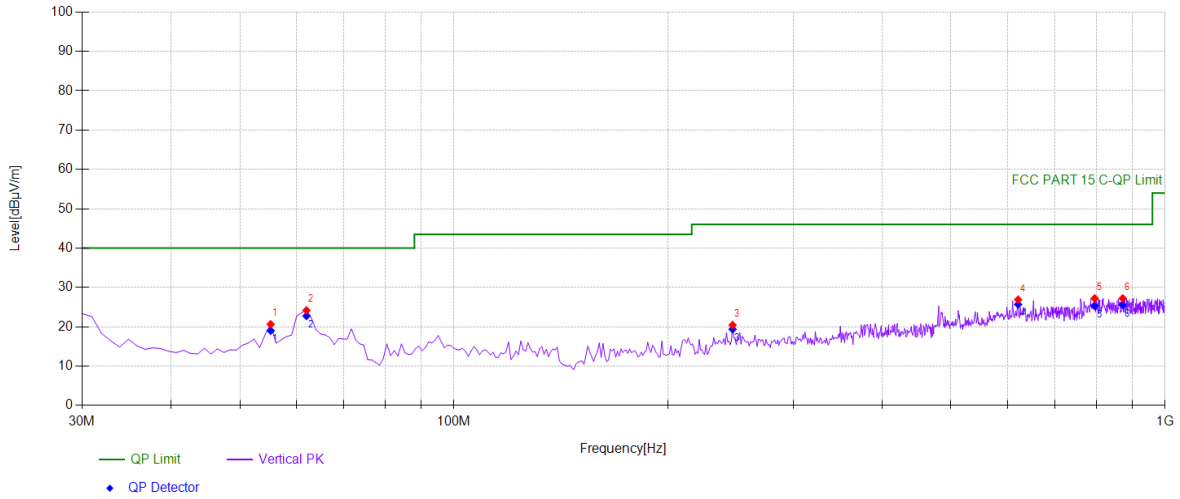

Suspected Data List								
NO.	Freq. [MHz]	Reading [dBµV]	Factor [dB/m]	Level [dBµV/m]	Detector	Limit [dBµV/m]	Margin [dB]	Polarity
1	55.2452	38.55	-17.91	20.64	PK	40.00	19.36	Vertical
2	62.042	43.01	-18.84	24.17	PK	40.00	15.83	Vertical
3	246.526	35.62	-15.18	20.44	PK	46.00	25.56	Vertical
4	621.321	33.97	-7.07	26.90	PK	46.00	19.10	Vertical
5	796.096	31.66	-4.46	27.20	PK	46.00	18.80	Vertical
6	871.831	30.59	-3.38	27.21	PK	46.00	18.79	Vertical

Final Data List					
NO.	Freq. [MHz]	Factor [dB/m]	QP Value [dBµV/m]	QP Limit [dBµV/m]	QP Margin [dB]
1	55.2452	-17.91	19.03	40.00	20.97
2	62.042	-18.84	22.76	40.00	17.24
3	246.5265	-15.18	19.39	46.00	26.61
4	621.3213	-7.07	25.68	46.00	20.32
5	796.0961	-4.46	25.34	46.00	20.66
6	871.8318	-3.38	25.55	46.00	20.45

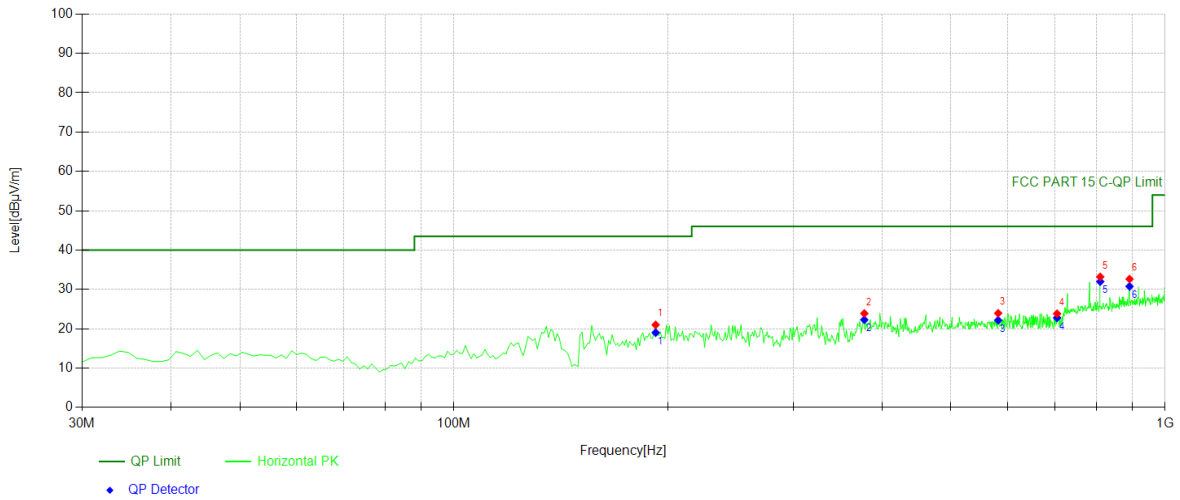

Suspected Data List								
NO.	Freq. [MHz]	Reading [dBµV]	Factor [dB/m]	Level [dBµV/m]	Detector	Limit [dBµV/m]	Margin [dB]	Polarity
1	192.152	38.61	-17.61	21.00	PK	43.50	22.50	Horizontal
2	377.607	35.92	-12.02	23.90	PK	46.00	22.10	Horizontal
3	582.482	31.09	-7.14	23.95	PK	46.00	22.05	Horizontal
4	704.824	29.73	-5.89	23.84	PK	46.00	22.16	Horizontal
5	810.660	37.55	-4.34	33.21	PK	46.00	12.79	Horizontal
6	891.251	35.51	-2.87	32.64	PK	46.00	13.36	Horizontal

Final Data List					
NO.	Freq. [MHz]	Factor [dB/m]	QP Value [dBµV/m]	QP Limit [dBµV/m]	QP Margin [dB]
1	192.1522	-17.61	19.02	43.50	24.48
2	377.6076	-12.02	22.28	46.00	23.72
3	582.4825	-7.14	22.17	46.00	23.83
4	704.8248	-5.89	22.78	46.00	23.22
5	810.6607	-4.34	31.98	46.00	14.02
6	891.2513	-2.87	30.77	46.00	15.23

7.6 CONDUCTED EMISSION TEST

7.6.1 Applicable Standard

According to FCC Part 15.207(a)

7.6.2 Conformance Limit

Frequency(MHz)	Conducted Emission Limit	
	Quasi-peak	Average
0.15-0.5	66-56	56-46
0.5-5.0	56	46
5.0-30.0	60	50

Note: 1. The lower limit shall apply at the transition frequencies
2. The limit decreases in line with the logarithm of the frequency in the range of 0.15 to 0.50MHz.

7.6.3 Test Configuration

Test according to clause 6.3 conducted emission test setup

7.6.4 Test Procedure

The EUT was placed on a table which is 0.8m above ground plane.
Maximum procedure was performed on the highest emissions to ensure EUT compliance.
Repeat above procedures until all frequency measured were complete.

7.6.5 Test Results

Pass

The AC120V &240V voltage have been tested, and the worst result recorded was report as below:

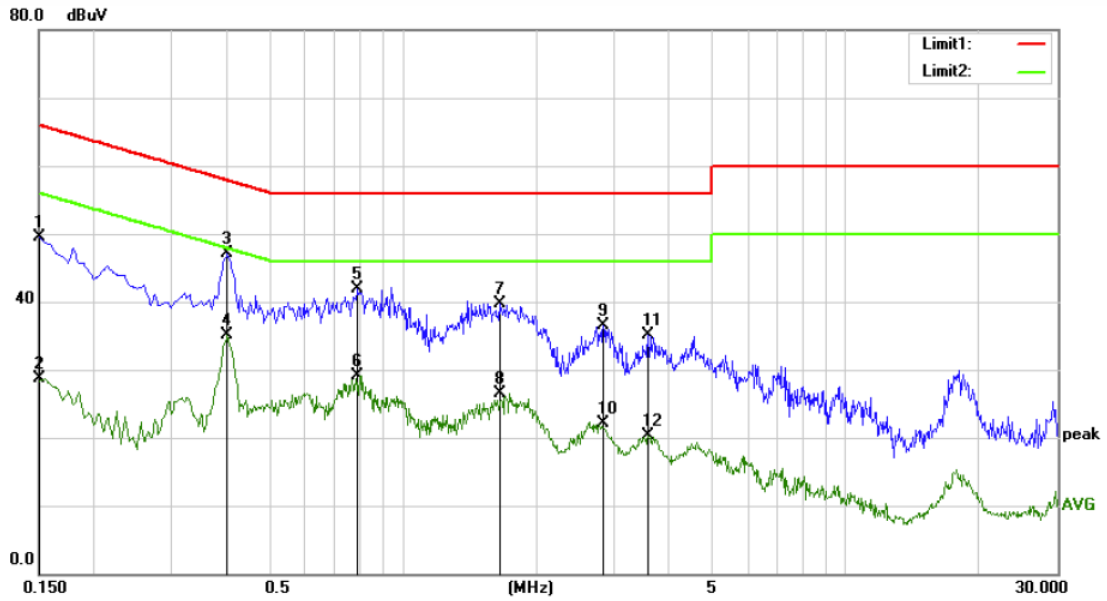

Site Conduction #1 Phase: **N** Temperature: 20.8
 Limit: (CE)FCC PART 15 class B_QP Power: AC 120V/60Hz Humidity: 61 %
 Mode: wifil mode
 Note:

No.	Mk.	Freq.	Reading Level	Correct Factor	Measurement	Limit	Over	Detector	Comment
		MHz	dBuV	dB	dBuV	dBuV	dB		
1		0.1500	40.05	9.51	49.56	66.00	-16.44	QP	
2		0.1500	19.16	9.51	28.67	56.00	-27.33	AVG	
3	*	0.4000	37.20	9.82	47.02	57.85	-10.83	QP	
4		0.4000	25.31	9.82	35.13	47.85	-12.72	AVG	
5		0.7900	32.19	9.71	41.90	56.00	-14.10	QP	
6		0.7900	19.47	9.71	29.18	46.00	-16.82	AVG	
7		1.6450	29.89	9.75	39.64	56.00	-16.36	QP	
8		1.6450	16.75	9.75	26.50	46.00	-19.50	AVG	
9		2.8250	26.73	9.76	36.49	56.00	-19.51	QP	
10		2.8250	12.44	9.76	22.20	46.00	-23.80	AVG	
11		3.5700	25.29	9.80	35.09	56.00	-20.91	QP	
12		3.5700	10.45	9.80	20.25	46.00	-25.75	AVG	

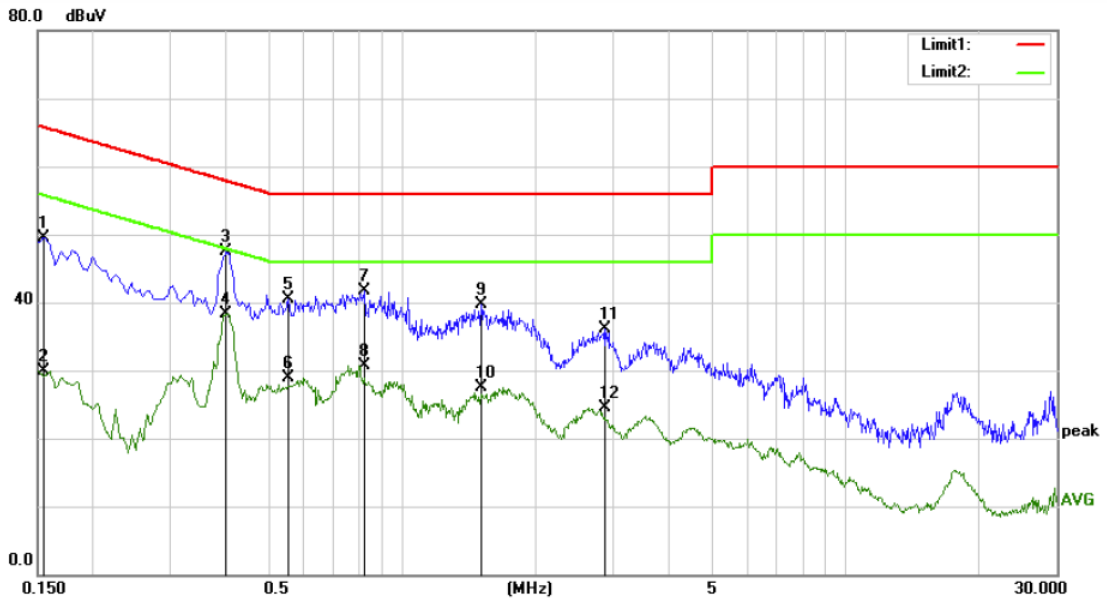

Site Conduction #1 Phase: **L1** Temperature: 20.8
 Limit: (CE)FCC PART 15 class B_QP Power: AC 120V/60Hz Humidity: 61 %
 Mode: wifil mode
 Note:

No.	Mk.	Freq. MHz	Reading Level dBuV	Correct Factor dB	Measure- ment dBuV	Limit dBuV	Over dB	Detector	Comment
1		0.1550	40.02	9.57	49.59	65.73	-16.14	QP	
2		0.1550	20.40	9.57	29.97	55.73	-25.76	AVG	
3		0.4000	37.70	9.82	47.52	57.85	-10.33	QP	
4	*	0.4000	28.57	9.82	38.39	47.85	-9.46	AVG	
5		0.5550	30.81	9.66	40.47	56.00	-15.53	QP	
6		0.5550	19.21	9.66	28.87	46.00	-17.13	AVG	
7		0.8250	31.95	9.73	41.68	56.00	-14.32	QP	
8		0.8250	20.99	9.73	30.72	46.00	-15.28	AVG	
9		1.5050	29.98	9.77	39.75	56.00	-16.25	QP	
10		1.5050	17.77	9.77	27.54	46.00	-18.46	AVG	
11		2.8750	26.28	9.76	36.04	56.00	-19.96	QP	
12		2.8750	14.65	9.76	24.41	46.00	-21.59	AVG	

7.7 ANTENNA APPLICATION

7.7.1 Antenna Requirement

Standard	Requirement
FCC CRF Part15.203	An intentional radiator shall be designed to ensure that no antenna other than that furnished by the responsible party shall be used with the device. The use of a permanently attached antenna or of an antenna that uses a unique coupling to the intentional radiator shall be considered sufficient to comply with the provisions of this section. The manufacturer may design the unit so that a broken antenna can be replaced by the user, but the use of a standard antenna jack or electrical connector is prohibited. This requirement does not apply to carrier current devices or to devices operated under the provisions of §15.211, §15.213, §15.217, §15.219, or §15.221. Further, this requirement does not apply to intentional radiators that must be professionally installed, such as perimeter protection systems and some field disturbance sensors, or to other intentional radiators which, in accordance with §15.31(d), must be measured at the installation site. However, the installer shall be responsible for ensuring that the proper antenna is employed so that the limits in this part are not exceeded.

For intentional device, according to FCC 47 CFR Section 15.203, an intentional radiator shall be designed to ensure that no antenna other than that furnished by the responsible party shall be used with the device. And according to FCC 47 CFR Section 15.247 (b), if transmitting antennas of directional gain greater than 6dBi are used, the power shall be reduced by the amount in dB that the directional gain of the antenna exceeds 6dBi..

7.7.2 Result

PASS.

- The EUT has one antenna: antenna gain is 2.0 dBi ;
 - Antenna uses a permanently attached antenna which is not replaceable.
 - Not using a standard antenna jack or electrical connector for antenna replacement
 - The antenna has to be professionally installed (please provide method of installation)

Which in accordance to section 15.203, please refer to the internal photos

Detail of factor for radiated emission

Frequency(MHz)	Ant_F(dB)	Cab_L(dB)	Preamp(dB)	Correct Factor(dB)
0.009	20.6	0.03	\	20.63
0.15	20.7	0.1	\	20.8
1	20.9	0.15	\	21.05
10	20.1	0.28	\	20.38
30	18.8	0.45	\	19.25
30	11.7	0.62	27.9	-15.58
100	12.5	1.02	27.8	-14.28
300	12.9	1.91	27.5	-12.69
600	19.2	2.92	27	-4.88
800	21.1	3.54	26.6	-1.96
1000	22.3	4.17	26.2	0.27
1000	25.6	1.76	41.4	-14.04
3000	28.9	3.27	43.2	-11.03
5000	31.1	4.2	44.6	-9.3
8000	36.2	5.95	44.7	-2.55
10000	38.4	6.3	43.9	0.8
12000	38.5	7.14	42.3	3.34
15000	40.2	8.15	41.4	6.95
18000	45.4	9.02	41.3	13.12
18000	37.9	1.81	47.9	-8.19
21000	37.9	1.95	48.7	-8.85
25000	39.3	2.01	42.8	-1.49
28000	39.6	2.16	46.0	-4.24
31000	41.2	2.24	44.5	-1.06
34000	41.5	2.29	46.6	-2.81
37000	43.8	2.30	46.4	-0.3
40000	43.2	2.50	42.2	3.5

*** End of Report ***